

January 24, 2012

Mr. Lawrence A. Melton  
Assistant Commissioner  
Office of Facilities Management  
and Services Programs  
Public Buildings Service  
U.S. General Services Administration  
1800 F Street, NW, Suite 1304  
Washington, D.C. 20405

Dear Mr. Melton:

On behalf of the U.S. Nuclear Regulatory Commission (NRC), I am responding to the U.S. General Services Administration's (GSA's) letter of November 14, 2011, requesting my acceptance of the renewed operations and maintenance Delegation of Authority and Interagency Agreement for the One White Flint North building located at 11555 Rockville Pike, Rockville, Maryland, 20852. Enclosed please find an original signed GSA Delegation of Authority and Interagency Agreement.

As always, I take great pride in the way the NRC manages the operations of this GSA asset. We will continue to protect this building and meet all the requirements stated in the Delegation of Authority and Interagency Agreement.

Sincerely,

*/RA/*

Gregory B. Jaczko

Enclosure:  
As stated

**DELEGATION OF AUTHORITY  
AND  
INTERAGENCY AGREEMENT  
BY AND BETWEEN  
THE U.S. GENERAL SERVICES ADMINISTRATION  
AND  
THE U.S. NUCLEAR REGULATORY COMMISSION  
FOR  
ONE WHITE FLINT NORTH**

In accordance with 40 U.S.C. §§ 121(d) and (e), and 3314(a)(2) and (b), and such other authorities vested in the Administrator of General Services (the "Administrator") to delegate or assign authorities and functions to other Executive agencies, I hereby delegate to the Chairman of the U.S. Nuclear Regulatory Commission (the "Chairman") the authority identified in section 1, below, and authorize the successive re-delegation of that authority within the U.S. Nuclear Regulatory Commission (the "Agency"), subject to the terms and conditions of this Delegation of Authority and Interagency Agreement. This Delegation of Authority and Interagency Agreement, together with the accompanying "Standard Operating Procedures for Operation and Maintenance of Delegated Real Property – November 2011" (the "SOP") and the December 2010 Proposed Facility Management Plan for the U.S. Nuclear Regulatory Commission's One White Flint North Building, Rockville, Maryland (the "Facility Management Plan"), attached hereto as Exhibits A and B, respectively, and incorporated herein by reference, are collectively referred to herein as the "Delegation." The Agency and the U.S. General Services Administration ("GSA") are collectively referred to herein as the "Parties" and each individually as a "Party."

1. Authority Delegated. The authority includes section 2 of Reorganization Plan No. 18 of 1950, 15 F.R. 3177, 64 Stat. 1270 (40 U.S.C. § 301 note), and 40 U.S.C. §§ 581(c)(6), 3305(b) and (c), 3308, and 3312 to perform the operation, maintenance and alteration of the One White Flint North Building, located at 11555 Rockville Pike, Rockville, MD (MD0798) (the "Facility"). Any contract entered into by the Agency pursuant to the authority delegated herein must be executed by a qualified and warranted contracting officer.

By accepting this Delegation, the Agency agrees to the terms and conditions set forth in the attached SOP, as such document may be revised from time to time by GSA, and the Facility Management Plan. The SOP contains terms and conditions applicable to all GSA operations and maintenance ("O&M") delegations, while the Facility Management Plan and the terms and conditions of this Delegation are specific to the Facility. In the event of a conflict between the Facility Management Plan and this Delegation, the terms and conditions of this Delegation will control. In the event of a conflict between a provision in the SOP and a specific provision in the Facility Management Plan, the specific provision in the Facility Management Plan will control.

## 2. Responsibilities of the Parties.

A. The Agency is responsible for the O&M of the Facility, unless otherwise provided herein, including:

- i. Interior cleaning;
- ii. Operating and maintaining the Facility;
- iii. Ordering and paying for utilities;
- iv. Altering space, including abatement work, if necessary; provided, however, that for alterations in excess of \$250,000, the Agency must have GSA's prior written concurrence;
- v. Overseeing occupant emergency planning;
- vi. Assigning and utilizing space in the Agency's delegated space perimeters for Agency occupants only;
- vii. Providing concessions services;
- viii. Operating and maintaining on-site child care facilities;
- ix. Managing and maintaining, at its sole cost and expense, asbestos-containing materials, surfaces containing lead-based paint, and any other materials containing hazardous substances, *e.g.*, fluorescent light bulbs and most equipment containing polychlorinated biphenyls, in accordance with the various environmental provisions referenced in the attached SOP, as such document may be revised from time to time by GSA, and in a manner that satisfies applicable federal, state and local statutory and regulatory requirements and is protective of human health and the environment; and
- x. Managing and maintaining, at its sole cost and expense, all underground storage tanks ("USTs") and associated piping at the Facility, except as otherwise provided in subsection 2,B.xi, below.

B. GSA retains certain responsibilities related to the Facility, including:

- i. Assessing the Agency's stewardship by regularly inspecting all aspects of the physical condition of the Facility and pertinent O&M records;

- ii. Replacing GSA purchased and installed Facility systems and their major components and repairing, as necessary, the exterior of the Building, as described in greater detail in Appendix B of the SOP;
- iii. Preparing and submitting required prospectuses for Congressional approval with the Agency's assistance;
- iv. When requested by the Agency, providing technical assistance and consulting services to the Agency, on a reimbursable basis, to supplement the Agency's capability;
- v. Conserving artwork;
- vi. Reviewing and approving all renovation projects affecting fire protection and life safety systems and equipment;
- vii. Maintaining all electrical transformers and high-tension switchgear and fire alarms not purchased and installed by the Agency;
- viii. Except as otherwise expressly provided by law, outleasing to non-Governmental entities and permitting and licensing occasional use activities under 40 U.S.C. § 581(h) and its implementing regulations;
- ix. Establishing charges and rates for space under the jurisdiction, custody or control of GSA;
- x. Asbestos (GSA projects only)
  - a. Providing the Agency with all asbestos surveys and abatement records that are within GSA's possession following renovations or projects completed by GSA that involve disturbance of asbestos-containing materials within the Facility;
  - b. Marking all remaining asbestos-containing materials in areas affected by GSA projects that involve disturbance of asbestos-containing materials; and
  - c. Performing all work that involves disturbance of asbestos-containing materials in areas affected by GSA projects in accordance with applicable federal, state and local statutory and regulatory requirements; and
- xi. For those USTs and their associated piping that GSA has installed or later installs on the property, GSA will undertake, at its sole cost and expense, to remove or decommission all such UST systems when the determination is

made by the Agency, GSA, or the regulatory authority with appropriate jurisdiction, that such UST system needs to be removed from service. In such a situation, GSA has discretion as to whether such a removal or decommissioning will be accomplished by closing the UST system in place or excavating and removing the UST system from its location. With both the removal of a UST system from service as well as the installation of a new UST system, GSA will undertake the work in a manner that satisfies applicable federal, state and local statutory and regulatory requirements and is protective of human health and the environment. Except for USTs installed by the Agency, GSA will register all UST systems with the appropriate regulatory authorities.

### 3. Performance of the Work.

A. The Agency must perform or cause to be performed all work at the Facility in accordance with the attached SOP and Facility Management Plan and the other terms and conditions of this Delegation.

B. The Agency agrees that all design and construction work undertaken by or on behalf of the Agency under this Delegation will be prosecuted with all reasonable diligence and without undue interruption, and will be completed in a good and workmanlike manner, with materials and products of appropriate quality and consistent with any manufacturer's specifications for such materials or products. The Agency and its contractors must take all necessary or appropriate actions and precautions in performance of the work to avoid causing any damage to the Facility.

### 4. Indemnification, Financial Responsibility and Insurance Requirements.

A. The Agency must require in its performance agreements for any portion of any work performed in accordance with the terms and conditions of this Delegation that the contractor(s) will save, indemnify and hold harmless GSA, the Agency and the United States, and their employees, officers, representatives, and agents, in both their individual and official capacities, from and against all liabilities, claims, demands, causes of action, suits, costs, and expenses (including, without limitation, attorneys' fees and expenses, and court costs) arising from or relating to the operations of the contractor(s) that cause damage to persons or property. Before commencing any construction activities under this Delegation, each contractor must deliver evidence to the Agency, with a copy to GSA, that it has obtained at least \$5,000,000 comprehensive general public liability and property damage insurance policies to cover claims arising from or relating to the contractor's operations that cause damage to persons or property; such insurance must name the United States, acting by and through the Administrator and the Chairman, as an additional insured. This condition may be met by separate policies. The contractor(s) must maintain the required insurance at all times during the contract. All aforesaid policies of insurance must be in companies of generally

recognized responsibility. All policies of insurance must provide that they may not be canceled without at least 30 days' prior written notice to the Agency and GSA.

B. By accepting the terms and conditions of this Delegation, and without the need for further documentation, the Agency agrees to accept full responsibility for all work performed under this Delegation, and to correct, or cause to be corrected, promptly any non-conforming work or property damage identified by an authorized GSA representative, including damage to the space or property of any other tenant or occupant in the Facility, at no cost or expense to GSA. Notwithstanding the requirements of subsection 4.A, above, the Agency will remain liable and financially responsible to GSA for any and all personal or property damage caused, in whole or in part, by the acts or omissions of the Agency, its employees, agents, and contractors.

5. GSA Quality Assurance Program. GSA will monitor the Agency's performance under this Delegation and will have the right, but not the obligation, to conduct inspections from time to time to determine if the work is being performed in accordance with the terms and conditions of this Delegation. If GSA determines that the Agency is not in compliance with the terms and conditions of this Delegation, GSA and the Agency will develop a Corrective Action Plan, as described in greater detail in section 6, below.

6. Corrective Action Plan. If GSA determines that the Agency's performance of the functions and responsibilities pursuant to this Delegation is not in compliance with the terms and conditions of this Delegation, GSA will notify the Agency. GSA and the Agency promptly will jointly develop a Corrective Action Plan to address any such performance problems. A copy of the Corrective Action Plan will be provided to the Chairman and to GSA's Commissioner of Public Buildings. If, following implementation of the Corrective Action Plan, the Agency's performance does not improve in GSA's reasonable judgment, GSA may rescind this Delegation, as provided in section 9, Discontinuance, below.

7. Access to Sensitive But Unclassified Building Information. Each employee of a contractor or subcontractor must have the appropriate security clearance to perform the work and must execute a Release and Non-Disclosure Agreement for Sensitive But Unclassified ("SBU") building information, a copy of which is attached hereto as Exhibit C and incorporated herein by reference. Each contractor and subcontractor must be registered in the Central Contractor Registration database, in accordance with Federal Acquisition Regulation subpart 4.11. Each individual requesting access to SBU building information, including employees of the Agency, will be required to execute a Release and Non-Disclosure Agreement prior to being provided access to any SBU building information. The Director of the Agency's O&M services staff must collect the executed Release and Non-Disclosure Agreements and transmit copies to GSA's designated customer service representative. By executing the Release and Non-Disclosure Agreement, the employees of the Agency and its contractors and subcontractors will have the right to request access to the SBU building information relating to the project.

The Agency, its contractors and subcontractors, each agree to comply with the terms and conditions of the Release and Non-Disclosure Agreement for SBU building information. All SBU building information generated by the Agency, its contractors and subcontractors, must be marked as directed by GSA's designated customer service representative and treated in the same manner as SBU building information provided by GSA. When the project for which the SBU building information was provided or generated is complete, the Director of the Agency's O&M services staff must send the written confirmations of disposal or return of documents, as well as any SBU building information that has not been destroyed by the contractors, subcontractors or the Agency, to GSA's designated customer service representative; provided, however, that any such disposal or return of documents is subject to the Agency's applicable records retention schedules. Any unauthorized disclosure of SBU building information must be reported promptly by the Agency to GSA's designated customer service representative. In the event of an unauthorized disclosure of SBU building information, GSA reserves the right to rescind this Delegation.

#### 8. Claims.

A. The Parties acknowledge that GSA will have no responsibility or liability, either directly or indirectly, for any contractual claims or disputes that arise out of or relate to the performance of the work at the Facility under the terms of this Delegation, except to the extent such claim or dispute arises out of or relates to the wrongful acts or negligence of GSA's agents or employees.

B. The Agency must administer and defend any claims and actions, and, except as otherwise expressly provided herein, be responsible for all liabilities arising out of or relating to the performance of the work at the Facility by the Agency or its contractors under the terms of this Delegation.

C. The Agency will be responsible for the payment of any judgments rendered or settlements agreed to in connection with contract claims or other causes of action arising out of or relating to the performance of the work at the Facility by the Agency or its contractors under the terms of this Delegation.

9. Discontinuance. Either the Administrator may rescind the Delegation or the Chairman may terminate the Delegation by providing written notice to the other Party. The rescission or termination, as applicable, will be effective as soon as the Parties are able to arrange for the orderly transition of service providers under contract at the Facility and GSA is able to staff the Facility appropriately. In the event of rescission or termination, the Agency will continue to be responsible for any and all costs and expenses incurred in connection with the performance of the work at the Facility by or at the direction of the Agency or its contractors under the terms of this Delegation, including the costs of closing out or transferring any on-going contracts or the payment of claims, and will remain responsible for all costs and expenses of O&M at the Facility

incurred by either Party, until GSA is able to assume budgetary responsibility and acquire the necessary resources for the Facility.

10. Amendments. This Delegation is intended to reflect the agreement of the Parties. No collateral agreements or writings affect or supersede the terms of this Delegation, except as expressly specified herein. This Delegation may be modified or amended only by mutual written agreement signed by the respective agency heads, and such writing must expressly reference the Parties' intent to modify or amend this Delegation. GSA may revise the SOP from time to time. Such revisions will become binding on the Agency, unless the Agency objects, in writing, to the Administrator within 90 days of being notified of the revisions. The Administrator will issue a final written decision on any such objection within 30 calendar days after the Administrator's receipt of the Agency's objection.

11. Disputes.

A. Any dispute over the scope of this Delegation or the authority delegated hereunder will be settled by the Administrator in his or her sole discretion, which decision will be binding on the Parties.

B. Any other dispute involving a monetary claim between the Parties or a matter of law or legal interpretation will be resolved in the following manner:

i. To the maximum extent practicable, all such disputes should be resolved informally at the working level. In the event a dispute cannot be settled by the affected GSA and Agency program offices, it must be submitted, in writing, to the GSA Regional Administrator for the National Capital Region for resolution. As soon as practicable, the GSA Regional Administrator will issue a decision, in writing, to the Agency, resolving the dispute. The GSA Regional Administrator's decision will be final, unless the Chairman files a written appeal, setting forth the basis for the Agency's position, including all supporting documentation, with the Administrator, within 30 calendar days after receiving the GSA Regional Administrator's written decision. The Administrator will issue a final written decision on any such appeal within 30 calendar days after the Administrator's receipt of the Agency's appeal.

ii. If, after exhausting its appeals under subsection 11.B.i, above, the Agency wishes to appeal the dispute further, and the dispute involves a monetary claim between the Parties or a transactional dispute, the Agency may request that the dispute be resolved in accordance with OMB Bulletin M-07-03, entitled "Business Rules for Intergovernmental Transactions."

iii. If, after exhausting its appeals under subsection 11.B.i, above, the Agency wishes to appeal the dispute further, and the dispute involves an interagency legal dispute that cannot be resolved by agency counsel, the GSA General Counsel and the



Agency General Counsel will jointly submit the matter to the Attorney General of the United States for resolution in accordance with Executive Order 12146 (or any succeeding Executive Order).

iv. Any decision of the Chief Financial Officers' Council or the Attorney General, as applicable, will be final and binding on the Parties, and the Parties must then coordinate to implement the decision promptly. Pending a final decision by the Chief Financial Officers' Council or the Attorney General, as applicable, the final decision of the Administrator will remain in effect.

12. Miscellaneous.

A. This Delegation will not affect any pre-existing or independent relationships or obligations between the Agency and GSA.

B. The provisions of this Delegation that require performance after the rescission or termination of this Delegation will remain in force and effect notwithstanding the rescission or termination of this Delegation.

C. If any provision of this Delegation is determined to be invalid or unenforceable, the remaining provisions will remain in force and unaffected to the fullest extent permitted by law and regulation.

D. This Delegation may be executed in counterparts, each of which will be deemed a duplicate original.

13. No Rights Created in Third Parties. Nothing in this Delegation is intended or will be construed to create any rights or remedies for any third party, and no third party is intended to be a beneficiary of this Delegation.

14. Effective Date. This Delegation is effective on the date of the Agency's acceptance, below, and remains in effect through November 30, 2016, unless earlier rescinded or terminated as provided in section 9, Discontinuance, above, or as otherwise modified or amended under section 10, Amendments, above.

*[Remainder of page intentionally left blank.  
Signature page to follow.]*

IN WITNESS WHEREOF, the Parties have executed this Delegation on the dates hereinafter identified.

DELEGATED BY:

U.S. GENERAL SERVICES ADMINISTRATION,  
acting by and through the ADMINISTRATOR  
OF GENERAL SERVICES and authorized  
representatives

  
\_\_\_\_\_  
Martha Johnson  
Administrator of General Services

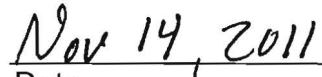
  
\_\_\_\_\_  
Date

ACCEPTED AND AGREED TO BY:

U.S. NUCLEAR REGULATORY COMMISSION,  
acting by and through the CHAIRMAN OF THE  
U.S. NUCLEAR REGULATORY COMMISSION  
and authorized representatives

  
\_\_\_\_\_  
Gregory Jaczko  
Chairman  
U.S. Nuclear Regulatory Commission

  
\_\_\_\_\_  
Date

Attachments

IN WITNESS WHEREOF, the Parties have executed this Delegation on the dates hereinafter identified.

DELEGATED BY:

U.S. GENERAL SERVICES ADMINISTRATION,  
acting by and through the ADMINISTRATOR  
OF GENERAL SERVICES and authorized  
representatives

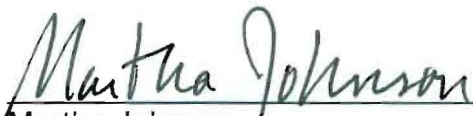
  
\_\_\_\_\_  
Martha Johnson  
Administrator of General Services

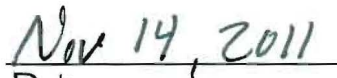
  
\_\_\_\_\_  
Date

ACCEPTED AND AGREED TO BY:

U.S. NUCLEAR REGULATORY COMMISSION,  
acting by and through the CHAIRMAN OF THE  
U.S. NUCLEAR REGULATORY COMMISSION  
and authorized representatives

  
\_\_\_\_\_  
Gregory Jaczko  
Chairman  
U.S. Nuclear Regulatory Commission

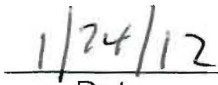
  
\_\_\_\_\_  
Date



Attachments

**EXHIBIT A**

**Standard Operating Procedures**



**Standard Operating Procedures  
for  
Operation and Maintenance  
of  
Delegated Real Property**

November 2011

General Services Administration  
Public Buildings Service  
Washington, DC 20405

# Standard Operating Procedures for Operation and Maintenance of Delegated Real Property

## Table of Contents

<b>Purpose</b> .....	4
<b>I. Agency-GSA Coordination</b> .....	4
<b>II. Funding for Building Operations, Maintenance and Repair</b> .....	4
<i>A. Agency Budgeting for Delegated Buildings</i> .....	4
<i>B. Full or Partial Delegation Discontinuance</i> .....	5
<b>III. Agency Responsibilities</b> .....	6
<i>A. Facilities Management Plan</i> .....	6
<i>B. Asset Business Team and Asset Planning</i> .....	9
<i>C. Preventive Maintenance</i> .....	9
<i>D. Utilities</i> .....	10
<i>E. Maintenance, Repair and Replacement</i> .....	18
<i>F. Cleaning</i> .....	18
<i>G. Grounds Maintenance</i> .....	18
<i>H. Environmental</i> .....	19
<i>I. Fire Protection and Life Safety</i> .....	23
<i>J. Engineering Inspections</i> .....	23
<i>K. Contracts</i> .....	23
<i>L. Assignment and Use of Space</i> .....	24
<i>M. Alterations</i> .....	25
<i>N. Concessions</i> .....	27
<i>O. Child Care</i> .....	28
<i>P. Missing Children</i> .....	29
<i>Q. Emergencies</i> .....	29
<i>R. Records</i> .....	30
<i>S. Property Protection</i> .....	30

**IV. Quality Assurance Program.....31**  
    *A. Customer Satisfaction .....31*  
    *B. Operational Review .....31*  
    *C. Building Engineering Reports .....32*  
**Appendix A – Building Operating Plan Outline.....33**  
**Appendix B – Operation, Maintenance and Repair Responsibilities.....35**  
**Glossary .....42**

# **Standard Operating Procedures for Operation and Maintenance of Delegated Real Property**

## **Purpose**

These Standard Operating Procedures (SOP) are intended to reflect the latest policies and best practices for federally owned and leased buildings, facilities and other real property under the jurisdiction, custody or control of the General Services Administration (GSA), Public Buildings Service (PBS). Any Agency operating and maintaining GSA-controlled real property under a Delegation of Authority has agreed to be bound by the terms, conditions, and procedures of this document. GSA/PBS may modify this document at any time to reflect current policy and practices. If an Agency objects to a change, it may appeal to the GSA Administrator, in writing, within 90 calendar days of receiving notice of the change. During the time of the appeal, the previous SOP will remain in effect. The Administrator's decision will be final. GSA's delegation of the operations and maintenance (O&M) of a building does not transfer jurisdiction, custody, control, or statutory responsibilities.

## **I. Agency-GSA Coordination**

The PBS Regional Commissioner in the GSA region where the property is located is responsible for coordinating operations between the Agency and GSA program offices. Unless otherwise specified, the Agency shall submit all data transmittals, approval requests, and required reports to the appropriate PBS Regional Commissioner. The Agency shall keep the PBS Regional Commissioner informed of the Agency officials currently responsible for coordinating the building delegation activities.

## **II. Funding for Building Operations, Maintenance, and Repair**

### **A. Agency Budgeting for Delegated Buildings**

When a delegation is granted, GSA will continue to operate, maintain and repair the building until the Agency has the budget to provide the services required under the delegation and as specified in Section III, Agency Requirements, below. The Agency must maintain a budget for operating, maintaining and repairing the delegated building. GSA will charge the Agency rent rates approximating commercial charges for comparable space and any services GSA continues to provide, which include a prorating of the fee charged to GSA for any delegated building located within a business improvement district. GSA will not charge for operating costs, repairs, alterations, or maintenance, or any combination thereof, that the Agency furnishes.

The Agency must budget for O&M costs based on the Agency's and GSA's current and historic operational data and projected future requirements. Through the asset



planning process and building reviews, GSA and the Agency will continue to work together to identify building maintenance problems and determine corrective action to ensure the long-term integrity of the building.

The Agency is required to report all annual O&M costs to GSA as required by Executive Order 13327 and based on the Federal Real Property Council standards.

## **B. Full or Partial Delegation Discontinuance**

Delegation agreements allow for either the head of the Agency to terminate or the GSA Administrator to rescind a delegation in full or in part. When a delegation is rescinded or terminated, the Agency must continue to budget for all operations, maintenance, repair, and overhead costs and expenses attributable to the building. The Agency must transfer these funds to GSA until such time as GSA is able to budget for the building's costs, which is usually no more than two budgetary cycles from the time the Agency gives notice of its intent to return any or all of the operational responsibilities to GSA. The delegation mandates that the Agency must begin to pay the full-service rent when GSA begins to operate the building with its own budgeted funds. Therefore, the Agency will need to budget for the actual full-service rent GSA will charge when GSA begins to operate the building with its own funds.

Once either party gives notice to the other party of its intent to discontinue a delegation, GSA and the Agency will:

1. Identify all service contracts for the building and highlight their costs and any pertinent terms and conditions. At GSA's request, the Agency must transfer funds by a Reimbursable Work Authorization (RWA) to pay for the balance of these contracts. If any of these contracts expire before GSA is able to include the annual contract cost in its budget, the Agency must continue to budget for the contract amount and annually transfer it to GSA by RWA funds.
2. Identify all current Agency contracts for operation, maintenance and repair related to the building. Identify standard level services versus above standard services provided in the contracts. GSA will review contracts as part of its determination to use existing GSA contracts, new GSA contracts or to take assignment of the Agency's existing contracts. To expedite the transfer of O&M responsibility to GSA, assigning any or all of these contracts to GSA may be advantageous. Assignment to GSA of any contract an Agency has entered into in the name of the U.S. Government is permissible, if both the Agency and GSA agree. When the Agency assigns such a contract to GSA, the Agency must transfer funds by RWA to pay for any and all remaining contract costs. GSA and the Agency will develop a schedule for an orderly transition of services and an estimate of standard versus non-standard costs, and identify administrative and other services that the Agency will continue to provide.
3. Initiate a building inspection to identify and estimate the costs and expenses of all outstanding maintenance and repair projects that have been the Agency's

responsibility under the terms of the delegation. The Agency must transfer to GSA by RWA the funds for completing all such work. If the Agency's current budget does not allow for this transfer, the Agency shall use its O&M funds retained from the prior year for this purpose. If there are insufficient funds, the Agency must budget for such costs and expenses over a reasonable time period agreed to by GSA and the Agency. Once the Agency has successfully budgeted for these costs and expenses, GSA will either collect for these costs and expenses through a miscellaneous billing adjustment by lump sum or amortize the amount over an agreed-upon period of time through the rent bill.

4. Determine by building inspection and cost analysis the financial consequence of any deferred repair and maintenance for which the Agency was responsible under the terms of the delegation. The Agency must transfer by RWA sufficient funds to cover the cost of all such remediation work. If the Agency does not have sufficient retained funds to cover this expense, it must budget for the expense and transfer by RWA this amount, as soon as it becomes available. At GSA's sole discretion, GSA may schedule the necessary remediation work before it receives reimbursement from the Agency or it may wait until after Agency funds are available.
5. Allot sufficient time to plan and coordinate the date for GSA to resume operation and maintenance responsibilities. This will allow time for GSA to put into place necessary O&M contracts, hire or reassign personnel to manage the property, and for the Agency to mitigate personnel issues arising from the discontinuance.

GSA will:

1. Include the building's full-service rent in the rent estimate in a timely manner, so that the Agency is able to budget the amount to be charged.
2. Include an estimate of services to be provided by reimbursable work authorization.
3. Assign a property manager to the building in the event of a full termination.
4. Apprise all affected GSA regional and Central Office personnel of the termination and its consequences, including budgetary impacts.

### **III. Agency Responsibilities**

#### **A. Facilities Management Plan**

The Agency must develop and administer an overall plan to ensure acceptable O&M of the building's fabric and systems. The Building Operating Plan (BOP) is the detailed record of operation and is a component of the Facilities Management Plan. A sample BOP outline is attached hereto as Appendix A and incorporated herein by

reference. The Facilities Management Plan oversees the O&M of all the building's structural and architectural elements, the building's systems, such as heating, ventilating, and air conditioning (HVAC), electrical, vertical transportation, plumbing, water treatment, as well as fire alarm and detection systems, fire suppression systems, fire pump and water supply systems, emergency power systems, fire extinguishers, energy conservation, landscaping, custodial services, and concessions. Contracted service providers, who usually perform the majority of these tasks, must be bonded, experienced, and qualified. The Facilities Management Plan must contain procedures for building inspection and the documentation of building service delivery.

The Agency must submit a Facilities Management Plan to GSA when seeking an initial delegation or redelegation of authority for a building. The following are components of a well-defined and administered Facilities Management Plan:

### **1. Maintenance and Repair Program**

- a. A preventive maintenance program is designed to perform periodically prescribed maintenance procedures and operational tests to mitigate degradation, maximize the reliability and optimize the design life cycle of all components of the building's fabric and building systems. Those performing the services must be qualified and possess current licenses and certifications, as required (verify state requirements for guidance). A process for scheduling, tracking execution and documenting the proper completion and associated costs of the preventive maintenance and testing procedures for each piece of equipment is needed. This process is usually supported through the use of a computerized maintenance management system (CMMS).
- b. A complete and accurate inventory of all equipment and systems within the facility requiring periodic preventive maintenance must be compiled and maintained. A systematic process of ensuring the inventory is updated as equipment is removed, replaced or added must be established and tracked, usually using a CMMS.
- c. The Agency must establish a process to identify equipment and system malfunctions and track continuous updates throughout the repair process. Service providers must use this procedure to document appropriate and timely corrective action. An effective operations maintenance and repair program establishes processes and procedures that minimize major repairs, system failures, unscheduled outages, and sources of tenant dissatisfaction. Agencies must establish tours of the building and equipment by operating and management personnel to identify problems and take corrective action prior to tenants even being aware of such problems. The Agency also must establish a service call procedure to notify responsible parties and track through completion all service failures. In the event that the tenants are affected by a system failure or outage, a process for communicating with and providing

continuous updates through the restoration of services must be established. Agencies must establish repair responsibilities and procedures for performing, documenting, tracking, and inspecting repairs, generally through a CMMS.

- d. The Agency's BOP must include descriptions of and operating procedures for all major building equipment and systems, sequences of operation, energy management strategies, utility curtailment plans, security and occupant emergency plans and procedures, hazmat procedures, main shut-off locations, as well as detailed descriptions of all facilities management services provided at the facility.

## **2. Custodial and Landscaping Program**

- a. The Agency must establish a complete custodial program designed to clean and preserve interior and exterior building asset finishes in a safe, effective, efficient, and environmentally friendly manner. This program includes daily and periodic cleaning of areas, as well as service call capabilities to ensure a healthy, attractive and safe environment. The type and frequency of cleaning procedures and the products to be used are necessary components of the program. A complete insect, pest and rodent control and prevention program also must be developed and include strategies for safe and effective techniques and products designed for the facility's particular vulnerabilities.
- b. The Agency must establish a complete inventory of all areas to be cleaned, including categories of surfaces to be cleaned, and a system for ensuring the inventory is updated as changes occur. A detailed daily and periodic cleaning plan that identifies all areas to be cleaned, the frequency and by whom must be developed by the service providers and approved by the regional facilities management office. The plan also must contain a detailed contingency plan for daily cleaning when custodial personnel are absent.
- c. The Agency must develop a landscaping program, which includes snow and ice removal, if applicable, to enhance the appearance of the facility and safety of the tenants and visitors. Personnel and contractors involved in the performance of these services must be qualified and experienced and possess current licenses and certifications, as required.
- d. Finally, the Agency must establish a process for identifying, documenting, tracking, and causing appropriate corrective action to be taken, and ensuring that service providers give notice to the facilities management office of building cleaning, grounds care, insect, pest, rodent, trash disposal and safety problems before they become health or tenant issues through tours of the building by custodial and management personnel, as well as a service call procedure to notify responsible parties and follow-up to ensure completion. The Agency must establish tours of the building and grounds by custodial and management personnel to identify problems and take corrective action prior to tenants

becoming aware of maintenance problems. The Agency must establish a service call procedure to notify responsible parties and track through completion all custodial-related service issues.

### **3. Inspection and Documentation of Services Performed**

- a. As an integral part of the Facilities Management Plan, the Agency must implement the inspecting, testing and certifying programs designed to oversee all services to ensure proper completion and identify potential problems. The Agency must develop an inspection program for each service, including the frequency of inspections, information to be collected during the inspections, titles of persons completing the inspections, documentation of inspection findings, and corrective actions for deficiencies.
- b. The Agency must maintain current building system inspection certificates, including fire alarm and suppression system testing results, emergency generator test results, occupancy certificate, elevator and escalator inspection certificates, boiler and pressure vessel inspection certificates, and underground storage tank (UST) certifications, and these certificates must be posted, as required, and current copies must be available on file.
- c. In addition to the Agency inspections, the GSA regional office will review the Facilities Management Plan during building inspections to determine whether it fully meets the needs of the building. The Agency agrees to review the plan annually to ensure that it reflects current building conditions. The Agency and GSA will develop a corrective action plan to address any deficiencies or necessary improvements.

### **B. Asset Business Team and Asset Planning**

GSA will extend membership on the Asset Business Team (ABT) to the Agency that is delegated authority to operate and maintain the building. The Agency must participate in regular ABT meetings to develop a long-term strategy for the building. The ABT will maintain an Asset Business Plan, which must include investments proposed for the building, a description of the building maintenance program as stated in the Facilities Management Plan and customer satisfaction data. GSA and the Agency will cooperate in the asset planning of the building to maximize customer satisfaction and minimize the cost of maintaining the asset. Asset strategies will be updated, as needed.

### **C. Preventive Maintenance**

1. **Adherence to Facilities Management Program.** The Agency must adhere to the facilities management program that is established for preventive maintenance.
2. **General Guidelines.** The Agency is responsible for establishing a preventive maintenance program for the building and all Government-owned building

operating equipment. At a minimum, the program requires a complete inventory of all Government-owned equipment, as well as information about the type and frequency of maintenance and inspection procedures following the manufacturer's recommendation for recurring maintenance. The Agency must keep the inventory current, preferably in electronic format, and provide it to the appropriate GSA official on request. The Agency must provide all maintenance, including inspections, in accordance with industry, manufacturer and GSA standards or, if approved by GSA, a contractor's recommendation, based on the contractor's knowledge and experience. The Agency is responsible for operating and maintaining all fire protection systems. This includes, but is not limited to: fire alarm and sprinkler systems; fire pumps; fire extinguishers; fire and smoke dampers; emergency lighting; exit signage; and special suppression systems currently installed in the building. The Agency will be responsible for testing, inspecting and maintaining all fire protection systems within the building in accordance with nationally recognized codes and standards. For example, automatic fire sprinkler systems must be maintained in accordance with the requirements of the National Fire Protection Association (NFPA) 25, Standard for the Inspection, Testing, and Maintenance of Water-Based Fire Protection Systems, and fire alarm systems must be maintained in accordance with the requirements of NFPA 72, National Fire Alarm Code. The GSA regional fire protection engineer must review and approve any proposed modifications to fire protection systems before the Agency initiates any changes. All modifications to fire protection systems must be performed by qualified, licensed technicians (e.g., National Institute for Certification in Engineering Technologies (NICET) Level II or higher). All fire protection systems must transmit alarm, supervisory and trouble signals to an Underwriters Laboratory (UL) listed central station. The Agency must provide and maintain two phone lines next to the fire alarm system main control panel for this purpose. The GSA National Capital Region (NCR) maintains most of the fire alarm and high voltage switchgear systems in NCR as described in the specific delegation agreement, with financial support from the delegated Agency.

3. **Preventive Maintenance Changes.** The Agency will work with the ABT and notify GSA of any deviation from the manufacturer's equipment maintenance guidelines.
4. **Preventive Maintenance Records.** The Agency must keep accurate records of program execution and make those records available to GSA upon request.

#### **D. Utilities**

1. **Energy Guidelines.** The Agency must follow an energy management and conservation plan to attain the energy, water and greenhouse gas reduction goals established in the Energy Policy Act of 2005 (EPACT 05); the Energy Independence and Security Act of 2007; Executive Order 13423: *Strengthening Federal Environmental, Energy, and Transportation Management*; the GSA

*Customer Guide to Real Property*, Chapter 3: Operating and Managing Buildings; and other applicable laws and authorities.

2. **Energy Audits.** GSA reserves the right to perform periodic, detailed energy audits of the building. GSA will provide a copy of audits indicating any deficiencies and necessary corrective actions to the Agency and will help the Agency develop a corrective action strategy.
3. **Alternative Financing.** Energy savings performance contracting (ESPC) was authorized in the Energy Independence and Security Act of 2007 on a permanent basis, along with adding utility energy savings contracts. The Agency is encouraged to use alternative financing mechanisms to reduce energy consumption. The Agency must obtain prior written authorization from GSA before entering into any alternatively financed energy conservation project.
4. **Utility Bills.** If it is delegated utility responsibility, the Agency must pay utility and fuel bills, including natural gas, coal, steam, chilled water, oil, electricity, and water and sewage, and alternatively financed energy conservation projects. The Agency agrees to retain copies of all utility bills for a 3-year period (or for the length of any ESPC contracts) and make the bills available to GSA upon request.
5. **Utilities Furnished by GSA.** For some buildings, GSA will furnish certain utilities to the Agency at cost. The cost will be recovered through the rent charged in the regular billing process and will be reflected in the Occupancy Agreement (OA). GSA furnishes utilities when one of the following occurs:
  - a. **Regionwide Contracts.** When load aggregation is prudent for the Federal Government, GSA reserves the right to include the Agency in a regionwide electricity or natural gas purchase contract. GSA may charge the Agency on a *pro rata* basis.
  - b. **Delegated Buildings that Share Meters with GSA-Operated Buildings.** When delegated buildings are not separately metered, GSA will pay the utility charges for the applicable building and charge the Agency on a *pro rata* basis.
  - c. **Steam and Chilled Water Supplied by GSA.** Customer agencies receiving steam or chilled water from the GSA Heating, Operation, and Transmission District (HOTD) in NCR are billed at cost for the steam or chilled water. GSA will determine the cost of steam or chilled water on the basis of supply line meter readings. GSA will be responsible for furnishing, installing, calibrating, repairing, and replacing meters. GSA's HOTD is committed to providing to each building high-pressure steam service that is safe and reliable. Safety and reliability for high-pressure steam service impose responsibilities on all parties concerned. Following are the responsibilities of HOTD and the Agency regarding the steam service and related equipment.

HOTD is responsible for the high-pressure steam supply to the building as follows:

- 1) HOTD is responsible for all equipment and piping for the supply of high-pressure steam to the building up to and including the high-side valve on each leg of the main pressure-reducing station in the building for the incoming high-pressure steam service (see Figure 1). On the bypass line of this main pressure-reducing station in the building, HOTD is responsible up to and including the bypass shut-off valve.
- 2) Opening or closing any building's main (incoming high-pressure) steam valve is to be done only by personnel from the HOTD Distribution Office. Building engineers or other personnel must not open or close any building's main steam valve. If the building's main steam service needs to be energized or de-energized for any reason, call the HOTD Distribution Office at 202-337-6260, and HOTD will send its personnel to the building to open or shut the main steam service valve. This applies to seasonal shut-down and start-up, as well as to any other shut-down and start-up undertaken to accomplish repairs, or for any other reason.
- 3) In an emergency situation, the Agency may take action contrary to what is stipulated in the immediately preceding paragraph by turning off the building's main steam service valve. In such event, the Agency must notify the HOTD Distribution Office immediately. The Agency must never turn on the building's main steam service valve; always call the HOTD Distribution Office to do this.
- 4) Whenever the building's main steam valve is shut off, HOTD's policy is that its personnel will chain and padlock the valve to prevent any unauthorized operation. The chain and padlock must not be removed until the valve has been turned back on again by HOTD personnel. Whenever HOTD personnel turn on or shut off the building's main service valve, they will first ensure that no water is remaining in the steam system. After verifying that the steam to the building is safely turned on or shut off, HOTD personnel will notify the building's manager or engineer.
- 5) The purpose of these procedures is to provide steam service operation that is safe for building personnel and HOTD personnel, and to prevent steam service interruptions within buildings resulting from steam system malfunction. Each building's main steam service valve has attached to it a sign that states: "Property of GSA/HOTD Steam Distribution Complex. DO NOT OPERATE. For service, call 202-337-6260." Do not remove this sign.
- 6) HOTD is responsible for all equipment and piping for return to HOTD of condensate from the high-pressure traps on HOTD's incoming high-pressure steam service to the building.



- 7) Regarding equipment and piping for return to HOTD of low-pressure condensate from the building, HOTD is responsible only for such equipment and piping that is downstream of the discharge of the building's condensate return pump(s).
- 8) HOTD is fully responsible for all equipment and piping, as specified above, including the operation, maintenance, repair, capital improvement, and replacement of any and all equipment and piping, as needed.

The Agency is responsible for steam pressure reduction and distribution in the building as follows:

- 1) The Agency is responsible for all piping and equipment for steam supply that is downstream of the high-side shut-off valve on each leg of the main steam pressure-reducing station that reduces pressure of incoming steam supply to the building. The high-side valve of a pressure-reducing station leg is the shut-off valve on the high-pressure side of the pressure-reducing valve on that pressure-reducing station leg (see Figure 1). The Agency's responsibility, therefore, includes the pressure-reducing valve on each leg of the pressure-reducing station for the building. The Agency also is responsible for all piping and equipment that is downstream of the bypass shut-off valve on the bypass line of the main steam pressure-reducing station in the building. HOTD is responsible for its steam supply line to the building only up to and including the high-side valve on each leg of the building's main steam pressure-reducing station, and up to and including the bypass valve on the bypass line of the station.
- 2) Although the Agency is not responsible for their maintenance, repair or replacement, please note that the Agency is authorized to operate the high-side shut-off valve on any leg of the main steam pressure-reducing station, as well as the station's bypass shut-off valve.
- 3) The Agency is responsible for all piping and equipment for low-pressure condensate return that is upstream of the building's condensate receiver pump(s) discharge.
- 4) The Agency is fully responsible for all equipment and piping on the building's side of the responsibility boundary as specified above, including the operation, maintenance, repair, capital improvement, and replacement of this equipment, as needed.
- 5) The Agency is responsible for conformance to HOTD design and installation standards for all new installations and all modifications of building steam station equipment and piping. HOTD requires conformance to the following building steam station design and installation standards:

- a) HOTD sign-off on design is required prior to new installations and modifications affecting the building steam station.
  - b) Only seamless steel pipe with cast or forged steel valves, fittings and nipples may be used for high-pressure steam.
  - c) Steam piping must be at least Schedule 40. Condensate piping must be at least Schedule 80.
  - d) No cast iron or brass may be used on piping, fittings, valves, or other piping system components.
- 6) The Agency is responsible to ensure appropriate qualifications of building engineer personnel who are responsible for the building's steam equipment and piping. All building engineer personnel must know steam system operation principles for up to 250 psi pressure steam, specifically including:
- a) Steam system operation thermodynamic and heat transfer principles and phenomena:
    - i) For steady-state operation;
    - ii) For controlled start-up, shut-down and system load variation;  
and
    - iii) For abnormal operation conditions, including abrupt changes, and water hammer conditions.
  - b) Specific dangers and potential accident scenarios of steam system operation, including how these can arise due to operation without adequate knowledge of underlying principles and appropriate procedures.
  - c) Steam piping expansion and contraction engineering principles.
  - d) Steam pressure-reducing station start-up procedures, including:
    - i) Steam condensate draining criteria and procedures;
    - ii) Gradual valve turning to limit piping expansion rate due to piping heat-up by steam; and
    - iii) Steam pressure-reducing valve regulation and troubleshooting.
  - e) Steam traps principles and procedures, including:
    - i) Steam trap types and operational principles;
    - ii) Steam trap placement principles;

- iii) Steam trap station components; and
  - iv) Checking of steam traps for proper function.
- d. **Water and Sewer Services in the District of Columbia.** In the District of Columbia, GSA has a citywide contract for water and sewer services for all buildings owned by the United States and under the jurisdiction of GSA. The District of Columbia allocates this charge among buildings and bills either GSA or GSA's tenant agencies directly. If GSA receives the bill, it will pass these charges on to the Agency.
- e. **Utility Usage Reports.** Annually, the Agency must report the utility usage to the Department of Energy, Office of Federal Energy Management Programs, Washington, DC 20585. The Agency must provide a copy of this report to GSA's Commissioner of Public Buildings.

**Figure 1: Responsibility Boundary  
at Building Main Steam Pressure-Reducing Station  
for Incoming High-Pressure Steam Service from GSA HOTD**

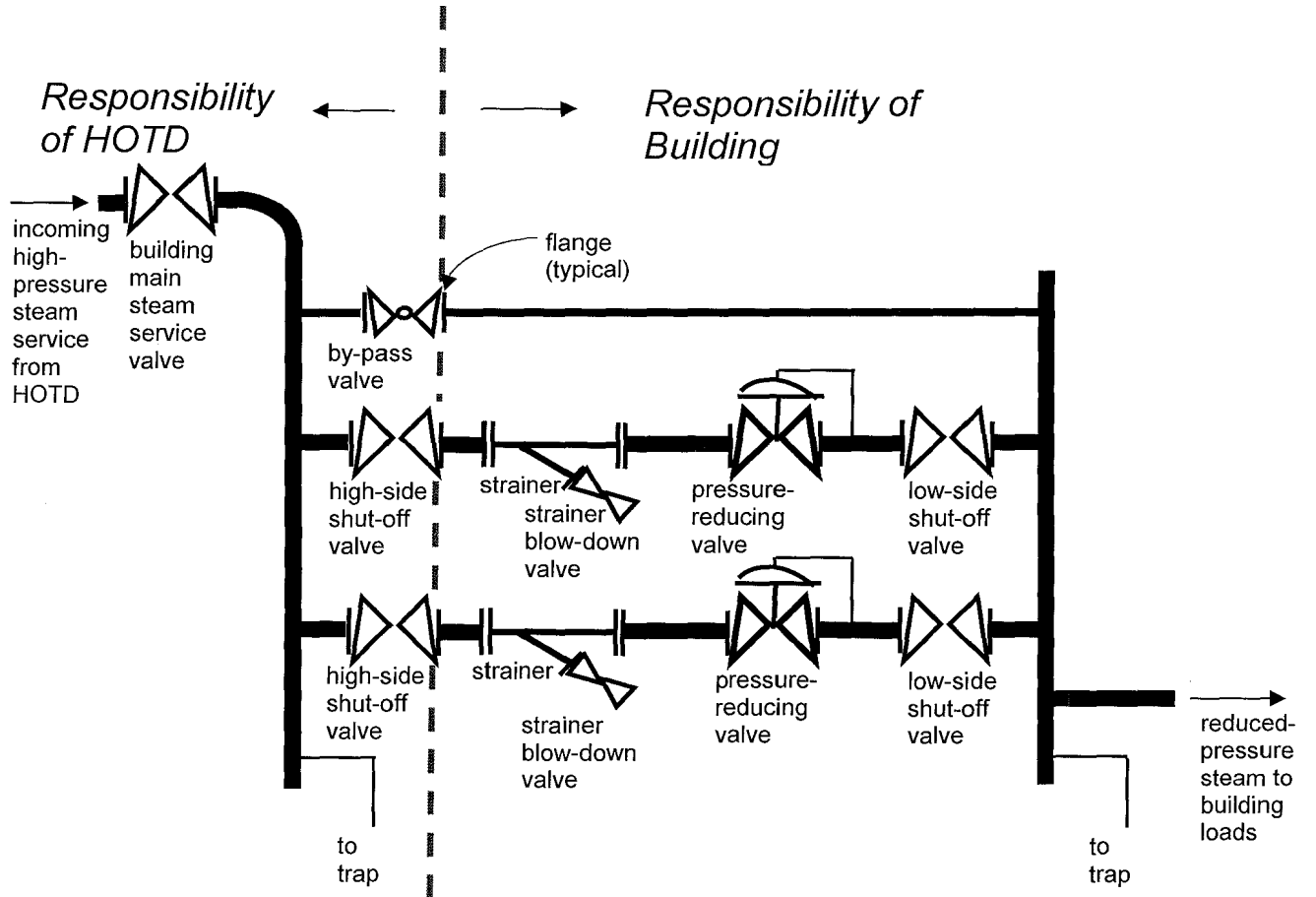

**Figure 2: Responsibility Boundary at Building Condensate Return System for Incoming High-Pressure Steam Service from GSA HOTD**

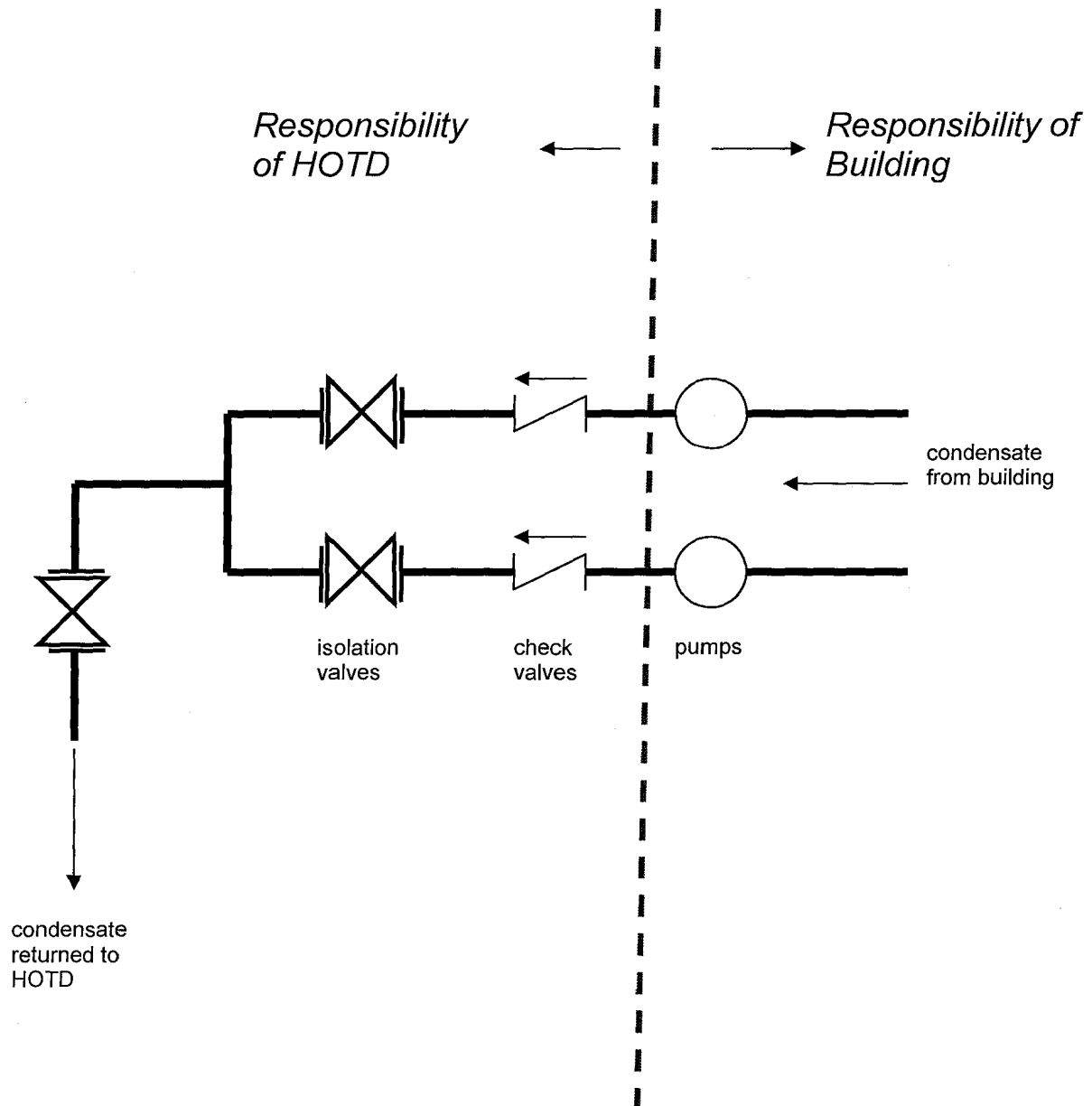

## **E. Maintenance, Repair and Replacement**

1. **Funding.** The Agency is responsible for funding and performing certain repairs and replacements as part of the regular maintenance of the building, as specified (although not an exhaustive list) in Appendix B, attached hereto and incorporated herein by reference.
2. **GSA Capital Replacement.** GSA is responsible for making necessary replacements to the building systems that are considered capital replacements, as specified in Appendix B. The Agency must notify GSA through the ABT of required or foreseeable capital replacements. For budgetary purposes, the Agency must rank in order of priority capital replacement projects and submit them to GSA with any studies, surveys or other data that verify the need for the replacement at least 18 months before the fiscal year in which the Agency requests the work. Within 21 calendar days of such notification, GSA will inform the Agency of the project's eligibility as a GSA-provided replacement and will provide a schedule for conducting a technical review and making a final decision. GSA will provide periodic updates on the project's status to the Agency. If, at any time during the term of this delegation, GSA determines that a prospectus is required for any proposed work, the Agency agrees to provide GSA with any information GSA deems necessary to prepare the prospectus request.
3. **Historic Buildings.** Repairs and replacements in historic buildings have specific requirements under the National Historic Preservation Act of 1966, 16 U.S.C. § 470 *et seq.* (see Section III.M.4, below, for more information).

## **F. Cleaning**

The Agency must perform building cleaning in a manner consistent with the approved Facilities Management Plan and Executive Order 13101, *Greening the Government Through Waste Prevention, Recycling, and Federal Acquisition*, to provide a healthful and attractive environment and to preserve and protect interior finishes. The Agency must use cleaning agents that are appropriate for the specific area to be preserved or cleaned. The Agency must procure environmentally preferable products, *e.g.*, those that are non-toxic or are bio-based to reduce the environmental impact of cleaning operations. The Agency's responsibility for exterior cleaning is detailed in Appendix B. Building cleaning includes, but is not limited to, janitorial services, recycling, window cleaning, and trash removal. Cleaning for child care centers must follow the National Association for the Education of Young Children (NAEYC) standards and includes care and maintenance of the playgrounds and outdoor equipment.

## **G. Grounds Maintenance**

The Agency must perform grounds maintenance in a manner consistent with the approved Facilities Management Plan to provide a healthful and attractive environment and to preserve and protect the grounds and landscaping. Grounds maintenance includes, but is not limited to, landscape maintenance, integrated pest management and trash and snow removal. Pesticide usage must be in accordance

with the label and the Federal Insecticide, Fungicide, and Rodenticide Act, 7 U.S.C. § 136 *et seq.*

## H. Environmental

1. **Standards and Regulations.** The Agency must comply with all applicable Federal, state and local environmental laws and implementing regulations, such as those issued by the U.S. Environmental Protection Agency (EPA) (Title 40 of the Code of Federal Regulations (C.F.R.)) and the U.S. Occupational Safety and Health Administration (OSHA) (Title 29 of the C.F.R.). In addition, the Agency must comply with all applicable safety and environmental management standards promulgated by state and local safety and environmental management regulatory agencies, and the standards set out in the GSA *Customer Guide to Real Property* and the Federal Management Regulation that relate to safety and environmental management (41 C.F.R. part 102-80, subpart B). Finally, the Agency must comply with all executive orders, including Executive Orders 12088 and 13514.

The safety and environmental management laws referenced in this section include the following, as any such law may be amended from time to time: the Federal Insecticide, Fungicide and Rodenticide Act, 7 U.S.C. § 136 *et seq.*; the Toxic Substances Control Act, 15 U.S.C. § 2601 *et seq.*; the Marine Mammal Protection Act, 16 U.S.C. § 1361 *et seq.*; the Endangered Species Act, 16 U.S.C. § 1531 *et seq.*; the Occupational Safety and Health Act, 29 U.S.C. § 651 *et seq.*; the Federal Water Pollution Control Act, 33 U.S.C. § 1251 *et seq.*; the Safe Drinking Water Act, 42 U.S.C. § 300f *et seq.*; the Solid Waste Disposal Act (commonly referred to as the Resource Conservation and Recovery Act (RCRA)), 42 U.S.C. § 6901 *et seq.*; the Clean Air Act, 42 U.S.C. § 7401 *et seq.*; the Comprehensive Environmental Response, Compensation and Liability Act (CERCLA), 42 U.S.C. § 9601 *et seq.*; the Emergency Planning and Community Right-to-Know Act, 42 U.S.C. § 11001 *et seq.*; the Hazardous Materials Transportation Act, 49 U.S.C. § 5101 *et seq.*

The following links are provided to assist the Agency in identifying means to comply with the environmental aspects of this delegation; the information is not all inclusive.

- Wastes, Resource Conservation, and Comprehensive Procurement Guidelines – [www.epa.gov/cpg/products.htm](http://www.epa.gov/cpg/products.htm).
- Lists of environment-related Executive Orders – [www.ofee.gov/eo/eo.asp](http://www.ofee.gov/eo/eo.asp).
- Environmental laws – [www.epa.gov/lawsregs/laws/index.html#env](http://www.epa.gov/lawsregs/laws/index.html#env).
- Bio-based products – <http://www.biobased.oce.usda.gov/fb4p/>.
- Recyclable construction waste management – [www.wbdg.org/tools/cwm.php](http://www.wbdg.org/tools/cwm.php).

- 2007 Buy Recycled Series: Construction Products – <http://www.epa.gov/osw/consERVE/tools/cpg/pdf/construct.pdf>
- Recycling services – [www.Earth911.com](http://www.Earth911.com).

Agencies also must seek assistance from their environmental, health and safety departments, and establish the means and methods for employees to report unsafe and unhealthy conditions.

2. **Recycling.** Executive Order 13423, *Strengthening Federal Environmental, Energy, and Transportation Management*, requires all Federal agencies to maintain waste prevention and recycling programs in all of their facilities in the most cost-effective manner possible. The Agency must develop and manage a recycling program that is in compliance with all state and local recycling requirements. Recycling programs must provide for recycling of mercury-containing equipment and fluorescent light bulbs to be managed as universal waste in accordance with the provisions of 40 C.F.R. part 273.
3. **Prohibition of Contaminants.** At no time may the Agency permit the installation or use of asbestos-containing material (ACM), lead solder on potable water systems, polychlorinated biphenyls (PCBs) or PCB devices, chlorofluorocarbons (CFCs), or any other hazardous substances, without prior written approval from GSA. In those circumstances where the use is approved by GSA, all hazardous materials must be installed and used in accordance with all applicable Federal, state and local laws and regulations.
4. **Air Emissions.** To the extent the Agency operates the facility in any way that subjects the facility to Federal, state or local air emission standards, including needing to obtain any permits to regulate such emissions, the Agency will ensure that such standards are satisfied and such permits are obtained.
5. **Discharges of Water.** To the extent the Agency operates any facility that has activities that are subject to the control of Federal, state or local clean water standards, the Agency must operate such facility in accordance with these standards, including obtaining any necessary National Pollution Discharge Elimination System permits and any permits for stormwater discharges attributed to the facility.
6. **Hazardous Wastes.** When the Agency undertakes any activity that generates a hazardous waste requiring treatment or disposal, or both, the Agency must obtain an EPA identification number and maintain copies of the hazardous waste shipment manifests for the period specified by applicable Federal or state law. If the Agency meets the definition of a large quantity generator of hazardous waste, the Agency must complete a Biennial Report. Facilities within the District of Columbia that generate more than 100 kg but less than 1,000 kg of hazardous waste in a calendar month also must complete and submit to the District of Columbia an annual self-certification of compliance with the requirements of 40



C.F.R. part 262, as modified by 20 D.C.M.R. § 4262. On request, copies of these manifests and reports must be sent to the appropriate PBS Regional Commissioner. The Agency must maintain shipment manifests, records of receipt at disposal sites and, when available, records of destruction for hazardous wastes for the period prescribed by applicable Federal, state and local regulation. GSA has the right to review these records at any time and take custody of the records when the delegation is rescinded or terminated.

7. **Indoor Air Quality.** Indoor air contaminant levels must not exceed those identified in the OSHA standards (29 C.F.R. part 1910, subpart Z), any GSA standards or any other applicable Federal requirement governing indoor air quality in Federal facilities. Industry-approved control actions are required any time that air contaminant levels are measured at concentrations above such levels. When neither OSHA nor GSA guidance covers a particular situation, other accepted guidelines, such as those of the National Institute for Occupational Safety and Health or the American Conference of Governmental Industrial Hygienists, must be followed. The Agency must ensure that the building is maintained to prevent water infiltration, discharge and accumulation, and resulting microbial growth. Cooling towers and associated equipment must be maintained according to industry practices. In the event of a potential Legionnaires' disease incident, the Agency must adhere to the applicable OSHA guidelines. The Agency must respond to indoor air quality complaints by conducting indoor air quality surveys, when necessary, and taking appropriate action to correct identified problems.
  
8. **Hazardous Materials Management.** A Federal agency occupying space under GSA's jurisdiction is responsible for returning the space in the same condition in which the Agency received it at the onset of occupancy. The Agency must not use, store or handle any hazardous materials on the premises, except in strict accordance with all applicable laws and regulations. The Agency must maintain an inventory of all chemicals, including material safety data sheets as described in OSHA Standard 1910.1200, including petroleum and petroleum-related products and substances brought onto the premises, update it annually, as required by OSHA and GSA, and submit a copy of the inventory when it is updated to the PBS Office of Facilities Management and Services Programs each year. Particular emphasis must be given to hazardous materials identified in statutes or regulations. In the event of an unplanned release of hazardous materials, whether inside or outside of any given structure, the Agency must take immediate steps to minimize and mitigate the risk, harm or damage to persons and property, and immediately notify the PBS Office of Facilities Management and Services Programs and the appropriate public safety officials. The Agency is responsible for any cleanup of such releases, whether performed pursuant to RCRA, CERCLA or otherwise, as required by the regulatory agency or agencies with jurisdiction over the release to address hazards created as a result of the release of the hazardous material. If the Agency undertakes any activity that generates a hazardous waste requiring disposal, the removal or disposal of the

hazardous waste must be accomplished in accordance with all applicable Federal, state and local requirements and as described above.

9. **Fuel Storage Tanks (under- and above-ground).** The Agency must comply with all applicable Federal, state and local requirements pertaining to the use and management of storage tanks. This includes all monitoring, inspections and repairs. The Agency is responsible for registering tanks with regulatory agencies, as appropriate, and paying any registration or annual fees established by the states and the District of Columbia under the EPA UST Standards and Requirements (40 C.F.R. part 280). The Agency also must comply with applicable provisions of the Energy Policy Act of 2005 (Public Law 109-58).
10. **Microwave and Radio Frequency Transmitters.** When the Agency uses or otherwise provides space for the installation of microwave or radio frequency (RF) transmitters, the Agency must comply with the Federal Communications Commission and other applicable Federal, state and local requirements. The Agency must ensure that an RF survey is conducted and that appropriate employees are provided with relevant training.
11. **Asbestos-Containing Material and Lead-Based Paint.** The Agency must maintain an asbestos management program that meets the requirements of the EPA Asbestos Hazard Emergency Response Act regulations. The Agency must comply with all applicable OSHA, EPA, GSA, state, and local jurisdiction, and other requirements governing the abatement, handling, storage, and disposal of lead-based paint (LBP) (29 C.F.R. parts 1910 and 1926). In buildings containing ACM and LBP, the Agency must maintain records required by law of assessments, abatement, abatement monitoring, operations and maintenance plans, periodic inspections, and the training of appropriate employees. The Agency must notify tenants of all locations within their space containing ACM and LBP. The Agency must notify all contractors of the locations of ACM and LBP in or near their work area and ensure all contractors have proper asbestos training in accordance with Federal, state and local requirements.
12. **Potable Water.** The Agency must operate any potable water system at the facility in accordance with the Safe Drinking Water Act, as implemented by applicable Federal, state and local regulations. This obligation includes any time the Agency performs any repair or alteration of the potable water system. The Agency also is responsible for routine water testing and any additional testing whenever there is a particular concern raised by occupants of space covered by this delegation. Results of such testing must be provided to GSA.
13. **Reimbursable Environmental Services.** Upon Agency request, GSA may provide reimbursable environmental services, subject to available GSA resources.

## **I. Fire Protection and Life Safety**

- 1. General Fire Safety Guidelines.** The Agency must comply with the fire safety requirements set out in: the Federal Management Regulation (41 C.F.R. part 102-80, subpart C); the GSA Facilities Standards for the Public Buildings Service, PBS-P-100 (revised March 2005), as the same may be revised from time to time; Public Law 102-522, Fire Administration Authorization Act of 1992 (commonly referred to as the Federal Fire Safety Act); Public Law 93-498, the Federal Fire Prevention and Control Act of 1974; OSHA regulations; applicable Federal laws and regulations; and other applicable and nationally recognized codes and standards. GSA is the Authority Having Jurisdiction for all fire safety or fire protection issues.
- 2. Fire Incident Investigation.** The Agency must investigate all fire incidents, regardless of severity. The Agency must complete a fire incident report (GSA Form 53) or fact sheet for all fire incidents, regardless of dollar loss or number of injuries related to the fire incident. The completed fire incident report or fact sheet must be submitted to the appropriate GSA regional fire protection engineering and life safety program office. GSA reserves the right to investigate any fire on the premises. A board appointed by the GSA Regional Administrator will investigate any fire incident resulting in death or losses greater than \$100,000.
- 3. Reimbursable Services.** Upon Agency request, GSA may provide fire protection and life safety reimbursable services, subject to available GSA resources.

## **J. Engineering Inspections**

On a periodic basis, GSA will conduct fire protection, safety and health, and environmental engineering inspections of all Government-owned delegated facilities. The Agency must undertake actions necessary to correct any deficiencies identified by GSA within 30 calendar days. The Agency must submit GSA Form 3559 Part II indicating the corrective action taken and the date of correction promptly upon completion of the work. When the deficiency cannot be corrected within 30 calendar days, the Agency must submit GSA Form 3559 Part III indicating the planned completion date. The Agency is responsible for any and all other required inspections, such as annual OSHA inspections, of its operations and facility.

## **K. Contracts**

- 1. GSA Supply Contracts.** The Agency may procure supplies and services from any available GSA sources. The Agency may request GSA to perform, on a reimbursable basis, any contract procurement or administrative functions that GSA provided before this delegation.
- 2. GSA Term Contracts.** The Agency may use GSA regionwide term contracts, provided that:

- a. The contract is written to permit the Agency's use.
  - b. The Agency nominates a warranted contracting officer (CO), in writing, to the GSA CO to be the GSA CO's contracting officer's representative, and the nominee is acceptable to the GSA CO.
  - c. The Agency provides a certification that funds are available for each purchase of contract services.
  - d. The contractors bill the Agency directly.
  - e. The Agency sends a copy of its procurement order to GSA for informational purposes. The CO's responsibilities for these contracts remain with GSA.
3. **GSA Contracting Services.** The Agency may request services for which GSA does not have an existing contract. GSA will provide requested services based on resource availability, GSA's workload and pre-existing priorities.
  4. **Agency Contracts.** All contracting Agency actions must follow the Federal Acquisition Regulation, the General Services Administration Acquisition Manual and other applicable GSA directives.

#### **L. Assignment and Use of Space**

1. **Space Assignment Responsibilities.** The Agency is responsible for all assigned space in areas that the Agency occupies, including office space, joint use space and parking. Joint use space may be occupied by a child care, fitness or health center. GSA remains responsible for space assignments in delegated buildings to tenants other than the Agency. The Agency may not sublease, outlease or re-assign any space assigned to it.
2. **Agency Return of Space.** If the Agency's return of space brings its occupancy to less than 90 percent of the usable space in the building or lease and the Agency does not have the concurrence of 100 percent of the rent-paying occupants to perform these O&M functions, the delegation may be rescinded or terminated.
3. **Notification of Rent Changes.** The Agency must notify GSA of any changes within delegated buildings that will affect rent billing, as soon as the change is complete.
4. **Building Services to Other Tenants.** The Agency is responsible for all building service functions for the entire building for all occupants. Since GSA does not collect O&M rent, the Agency is permitted to charge non-Agency tenants for their proportionate cost of maintaining any service, e.g., joint use space. These charges must be approved, in advance, by the GSA Administrator, or his or her designee. In general, this amount may not exceed what GSA would charge for this service. However, if the Agency is providing above-standard services, it may seek permission to charge actual cost. It is recommended that the Agency

coordinate with the GSA regional office so that GSA can incorporate service charge terms and conditions into the non-Agency OA. Either the Agency, if it has been delegated space alteration authority in the building, or GSA may provide reimbursable tenant alterations and other services, if requested by other tenants. The Agency must provide initial space alterations, on a reimbursable basis, if requested by GSA.

## **M. Alterations**

- 1. Responsibility and Review.** Space alterations generally are the responsibility of the Agency. The ABT has the right to review and comment on any proposed space alteration. The GSA regional office with jurisdiction over the building may grant or decline permission to alter space and its prior concurrence is required. Alterations above the threshold amount stated in the specific building delegation agreement may not proceed without GSA's prior review and approval. For projects above the threshold, the Agency must submit a written request for approval of the project to GSA as early in the planning process as possible and in no event less than 60 calendar days before it plans to issue a solicitation or request for proposal for the work. Detailed narratives, plans, drawings, or schematics must accompany this written request to allow GSA to evaluate the scope of the project and its impact on the building structure or systems. GSA will respond to the Agency's written request within 21 calendar days after receipt. If GSA requires or the Agency requests a technical review, GSA will advise the Agency of the estimated date the review will be completed. GSA will regularly inform the Agency of the review's progress. Upon completion of any space alteration, the Agency must submit as-built drawings and Spatial Data Management (SDM) compliant assignment drawings showing all changes to the building as a result of the work within 120 calendar days. GSA reserves the right periodically to inspect any project and may require an Agency to reject any work that does not comply with the approved scope of work or standard construction practices. The Agency is responsible for bringing all non-compliant work into compliance. See Section III. R, Records, for additional drawing guidance.
- 2. Guidelines.** Alterations must conform to the requirements in GSA's *Facilities Standards for the Public Buildings Service*, PBS-P-100 (revised March 2005), as the same may be revised from time to time, and the applicable accessibility standards set forth in the Federal Management Regulation at 41 C.F.R. § 102-76.65. A private restroom within the Agency space would be an Agency responsibility for accessibility compliance. If an Agency is pursuing an alteration project that involves a public restroom and is required to meet accessibility standards, the Agency would be responsible. In the event a restroom is not in compliance with the applicable accessibility standard, GSA would be responsible, unless it is clear that the non-compliance was caused by lack of regular maintenance by the Agency. Materials used in alterations will contain, to the extent practicable, recycled content.

3. **Fire Protection and Life Safety Systems.** The Agency must not change, modify or alter any existing fire protection or life safety system without first obtaining written approval from the GSA regional fire protection engineer. Fire protection systems and life safety systems include, but are not limited to, fire alarm systems, sprinkler systems, special suppression systems, standpipe systems, emergency lighting systems, exit signage, egress hardware, and exit stairways, exit access, and exit discharge. In addition, the GSA regional fire protection engineer must review any alteration work performed by the Agency that affects the operation or effectiveness of the fire protection system or life safety system and issue written approval before such alterations are made. In accordance with GSA's *Facilities Standards for the Public Buildings Service*, PBS-P-100 (revised March 2005), as the same may be revised from time to time, occupancy will not be permitted within any space undergoing renovation or alteration until the regional GSA fire protection engineer has issued a certificate of occupancy or temporary certificate of occupancy. When an Agency has altered the fire alarm system, the affected space must not be reoccupied until the Agency has received a certificate of occupancy from the regional GSA fire protection engineer.
4. **Historic Buildings.** For those delegated buildings that are either listed in, have been determined eligible for inclusion in or are potentially eligible for inclusion in, the National Register of Historic Places, the Agency is responsible under the National Historic Preservation Act of 1966, as amended, 16 U.S.C. § 470 *et seq.*, for reviewing all repair, maintenance and alteration work that affects the original materials in the building with the appropriate GSA Regional Historic Preservation Officer (RHPO), regardless of the project's cost. The RHPO is responsible for coordinating all external review by the state historic preservation office and, as necessary, by the Advisory Council on Historic Preservation and other interested parties.
5. **Artwork.** GSA is responsible for conserving artwork created through federally sponsored programs in buildings for which it has jurisdiction, custody or control. The Agency is responsible for safeguarding and reporting to GSA any loss of, or damage to, such property.
6. **Asbestos.** Alterations or repairs that may disturb materials containing asbestos must follow procedures approved by GSA, EPA and OSHA. The Agency must immediately report to GSA, in writing, any locations discovered to contain asbestos and any changes to known asbestos materials. The Agency must label and maintain the encapsulation of all ACM. Refer to Paragraph H.9. of this section for additional guidance on ACM management.
7. **GSA Support.** Upon the Agency's request, and if resources are available, GSA will provide design, supervision, management, and inspection services on a reimbursable basis for Agency projects.

## **N. Concessions**

1. **General.** GSA will delegate the authority to provide space for essential concession services in GSA-controlled buildings, where area commercial services are insufficient. Concessions consist of employee cafeterias, vending facilities operated by the blind under the Randolph-Sheppard Act, 20 U.S.C. § 107 *et seq.*, and the implementing regulations set forth at 34 C.F.R. part 395, minority business concessions operated under Section 8(a) of the Small Business Act, and pay telephones. Federal employee health units established pursuant to 5 U.S.C. § 7901 in multi-tenant buildings will be administered under the concessions program. The Agency must follow the applicable guidelines set forth in the GSA Concessions Management Desk Guide, available through the regional delegations liaison, the GSA *Customer Guide to Real Property* and the Federal Management Regulation at 41 C.F.R. § 102-74.40 *et seq.*
2. **Agency Responsibilities.** Under a full concessions delegation, the Agency is responsible for:
  - a. Developing technical specifications for, and negotiating and awarding, concessions contracts and permits.
  - b. Administering concession activities and, in particular, overseeing the contractor's or permit holder's performance in the areas of sanitation, preventive maintenance, safety, energy conservation, and service delivery.
  - c. Where applicable, ensuring compliance with the Randolph-Sheppard Act and providing services to state licensing agency activities, as required, in connection with permits.
  - d. Maintaining, repairing and replacing Government-owned food-service equipment in cafeterias.
  - e. Cleaning Randolph-Sheppard vending facilities (*i.e.*, snack bars with food services, sundry stands and vending machines) and maintaining and repairing public areas in and adjacent to any vending facility. The Agency must provide standard-level building services in these areas.
  - f. Cleaning Federal employee health units to the standards applicable to a medical clinic.
3. **GSA Responsibilities.** GSA is responsible for:
  - a. Providing, to the extent resources are available, technical supervision and management and inspection services, on a reimbursable basis, for functions that are the Agency's responsibility under the terms of this delegation.
  - b. Conducting a continuous program of evaluations to determine compliance with established policies and procedures and to ascertain overall effectiveness of program management.

**4. Partial Concessions Delegations.** Under a partial concessions delegation, GSA, rather than the Agency, is responsible for developing technical specifications and negotiating, awarding and administering concession contracts and permits. The Agency is responsible to the GSA CO for monitoring on-site contractor performance as described in Section III.N.2, above.

**5. Occasional Use Permits.** Under 40 U.S.C. § 581(h)(2), the Agency may make available, on occasion, by permit and under such terms and conditions as the Administrator deems to be in the public interest, auditoriums, meeting rooms, courtyards, rooftops, and lobbies in public buildings to persons, firms or organizations engaged in cultural, educational or recreational activities. The Agency must comply with the provisions of the Federal Management Regulation regarding occasional use of public space, 41 C.F.R. part 102-74 subpart D. The Agency may charge permit holders for the occasional use of this space. Generally, GSA only charges for above-standard custodial and guard services, and above-standard utilities. Any sums received from these permits under 40 U.S.C. § 581(h)(2) from non-Federal permit holders, whether collected by the Agency or sent directly to GSA, must be deposited into GSA's Federal Buildings Fund, unless otherwise expressly provided by law.

## **O. Child Care**

**1. Child Care Center Operation.** The Agency must ensure that the terms and conditions of the GSA Revocable License for Non-Federal Use of Real Property (GSA Form 1582) are fulfilled and that the NAEYC accreditation is achieved and maintained through the re-accreditation process.

**2. Building Services.** The Agency must provide the full range of building services to all child care centers, inclusive of playgrounds, in accordance with 40 U.S.C. § 590, the GSA Child Care Design Guide and the GSA Property Manager's Child Care Resource Book. This includes: lighting; heating; cooling; electricity; telephone service, including the installation of lines and equipment, as well as associated costs and expenses, such as long-distance capabilities; Internet computer access; custodial service to the level of cleaning appropriate for child care facilities; and security systems. The Agency must immediately correct all major health and safety violations identified by the annual health and safety inspection process.

**3. Child Care Center Furnishings and Equipment.** The Agency is responsible for the purchase, replacement and repair of office furniture, office machines and equipment, inclusive of service and maintenance agreements, classroom furnishings and equipment, and kitchen appliances, unless otherwise specified in the delegation. Classroom furnishings and equipment includes, but is not limited to, tables, chairs, cribs, strollers, high chairs, changing tables, bookshelves, and playground equipment. The Agency must conduct a physical inventory of Agency-purchased and -owned child care furnishings and equipment and provide GSA with an equipment inventory report every 3 years. The Agency is not responsible for



providing toys, educational materials or incidental or consumable items, such as books and food.

4. **Painting and Carpeting.** Child care space must be painted every 3 years, or more frequently, if needed, and floor coverings must be cleaned, repaired or replaced when soiled, in disrepair, when underlayment is exposed, or when there are noticeable variations in surface color or texture. The Agency is responsible for the care and renewal of all these materials and finishes.

5. **Playground Services.** The Agency is responsible for maintenance and routine care of the playground. Routine care includes cleaning equipment and rubber surfaces, removing leaves and debris, measuring mulch and adding additional mulch as necessary, and conducting grounds and equipment inspections to ensure compliance with the Consumer Product Safety Commission guidelines.

6. **Notification Requirements.** The Agency must notify the GSA regional child care coordinator, in writing, of any proposed modifications or alterations to child care space. The Agency must comply with the GSA Child Care Center Design Guide.

7. **Personnel Screening.** The Agency will initiate appropriate suitability determinations for child care employees and applicants, and will advise GSA when the background check requests are sent to the Department of Homeland Security (DHS) Federal Protective Service (FPS). Child Care Center providers are responsible for providing either FPS or designated Agency officials with appropriate forms and fingerprint cards for applicants and employees. After the request is processed, either FPS or the Agency must send GSA a letter indicating whether the employee or applicant has received a clearance or non-clearance.

8. **Replacements.** The Agency and GSA will jointly plan for the provision of major replacements to playground equipment and surfacing and interior space renovations to facilitate safe and effective child care operations. Replacements must take place when the equipment has reached the end of its useful life, typically every 12 years. See Appendix B for additional replacement responsibilities.

## **P. Missing Children**

The Agency is responsible for complying with the requirements of Subtitle D of Title III of Public Law 108-21, April 30, 2003 (the Code Adam Act), concerning the establishment of missing children procedures in Government-owned or -leased buildings, unless notified otherwise by GSA, in writing. The Agency must immediately either comply with applicable GSA procedures, or implement its own procedures in compliance with the Code Adam Act, in all delegated GSA facilities.

## **Q. Emergencies**

The Agency must operate the building and respond during all emergency situations. Emergency situations include, but are not limited to, fires, floods, accident and rescue operations, civil disturbances, and natural disasters. Designated Agency personnel must become thoroughly familiar with the Agency's Occupant Emergency

Plan (OEP) responsibilities as set forth in the Federal Management Regulation at 41 C.F.R. § 102-74.230 *et seq.*, and the O&M plan proposed by the Agency and approved by GSA and incorporated into this delegation. Emergencies must be communicated to the proper authorities, such as the fire department and utility company. The Agency is responsible for any clean-up or repair requirements resulting from the emergency. Funding responsibility will vary by situation. The Agency must immediately notify the FPS Regional Emergency Management Control Center of emergency situations and the actions taken to resolve the situation. The Agency also is responsible for all the necessary notifications described in other sections of this SOP. The facility OEP must include instructions on how child care programs are integrated into the Agency's plan. The Agency is responsible for having a written continuity of operations plan and conducting training exercises annually at a minimum.

## **R. Records**

1. The Agency must keep program and financial records of all delegation-related activities consistent with the regulations of the National Archives and Records Administration or the Comptroller General, as appropriate.

2. Where available, GSA will provide SDM-compliant assignment floor plans to the Agency within 30 calendar days after occupancy. In addition, where available, GSA may provide a complete set of computer-aided design (CAD) drawings. These drawings are SDM-compliant in that they follow the guidelines in the PBS CAD Standards and the PBS National Business Space Assignment Policy. The Agency must maintain as-built CAD drawings of all alterations to the building. The Agency must allow GSA access to the building for SDM auditing of the CAD drawings to ensure that GSA maintains current and accurate spatial data. For new delegations, the Agency is permitted access to all of GSA's records pertaining to GSA's operation of delegated buildings.

3. Within 120 calendar days after completion of all space alterations for a particular project, the Agency must submit as-built floor plans and SDM-compliant assignment drawings of the alterations to GSA in accordance with PBS CAD policy and the PBS National Business Space Assignment Policy. GSA will update the master assignment floor plans to reflect the alterations and provide updated assignment floor plans to the Agency within 30 calendar days of receipt of the as-built plans. Upon reasonable prior notice, the Agency must provide GSA with complete access to its space for the purpose of periodic space audits to verify the accuracy of GSA's master assignment floor plans. Within 30 calendar days of any changes to the master drawings, GSA will provide the Agency with updated assignment floor plans.

## **S. Property Protection**

Implicit in any delegation to operate and maintain a GSA building and its grounds is the authority and responsibility to protect and preserve the property. Although GSA's law enforcement authority and related security functions were transferred to the Secretary of Homeland Security under Section 403 of the Homeland Security Act

of 2002, Section 422 of that Act specifically retained for GSA the function and authority to protect and maintain the buildings and grounds under GSA's jurisdiction (see 6 U.S.C. § 232). Accordingly, although a GSA delegation of O&M authorities and functions vests the Agency with the responsibility to protect the property from harm, the GSA delegation does not include authority to provide law enforcement, security or related guard services. Under an Interagency Memorandum of Agreement between GSA and DHS, that authority is retained by DHS. GSA's O&M delegation does, however, include authority to take preventive protective measures or security precautions, such as installing locks on doors, fencing around the premises and security lighting, and to make emergency repairs to protect the property from damage or theft.

#### **IV. Quality Assurance Program**

##### **A. Customer Satisfaction**

1. **GSA Customer Satisfaction Survey.** Biennially, the Agency must assess customer satisfaction in all delegated locations. The Agency must use the GSA Customer Satisfaction Survey, which measures the level of building occupant satisfaction with a wide range of building services. Survey efforts must be coordinated between the Agency and the GSA contractor responsible for survey administration. The Agency must distribute the surveys and ensure adequate survey response. GSA is responsible for the administrative contract support cost of these biennial survey efforts. The GSA contractor will be responsible for providing the delegated Agency with building-level and Agency-level satisfaction reports. The contractor will provide duplicates of these reports to the appropriate GSA regional representatives.

2. **Customer Satisfaction Goals.** GSA has established a uniform customer satisfaction goal as part of its annual response to the Government Performance and Results Act. Each delegated building is expected to reach this prescribed level of customer satisfaction. The Agency must analyze building data and, if necessary, develop action plans for improving customer satisfaction. The Agency must coordinate action plans with the appropriate GSA regional representatives.

##### **B. Operational Review**

Biennially or more frequently, at the discretion of GSA regional management, GSA will conduct an operational analysis of the property site, building structure, fabric, systems, and equipment, as well as review the Agency's Facilities Management Plan. The Agency must allow GSA access to all areas of the building selected for inspection. At the conclusion of the review, GSA will provide a report describing the condition of the equipment selected for assessment. The report will identify all problems with the selected equipment. The Agency must analyze the condition reports and take corrective action, as necessary, to restore equipment to proper working order, ensure the proper future operation of building systems and provide for overall stewardship of the asset. Agency action plans must be coordinated with the appropriate GSA regional representatives. The Agency's failure to take

appropriate action may result in a partial rescission of the delegation, the return of certain responsibilities to GSA and charging the Agency additional rent for the services to be provided by GSA.

### **C. Building Engineering Reports**

GSA collects information on overall building condition through a Building Engineering Report (BER) and Physical Condition Survey (PCS), which allows GSA to identify building deficiencies, develop budgets to correct them and prioritize the work items. The Agency must participate in the BER and PCS process, or other similar GSA programs, by providing all of the requested building information and escorting GSA contracted engineering firms through delegated buildings. Generally, the full BER is conducted every five years. In addition, Web-BER is being utilized to access real-time building conditions.

## **APPENDIX A – BOP OUTLINE**

### **GENERAL GUIDANCE**

#### **OPERATIONAL PROCEDURES AND SITE PLANS**

- BOILER PLANT
- CHILLER PLANT
- DOMESTIC HOT WATER PLANT
- HEATING BOILER PLANT
- GENERAL PLUMBING AND DOMESTIC WATER SYSTEMS
- WATER TREATMENT PLAN
- FIRE ALARM SYSTEMS
- FIRE SUPPRESSION SYSTEMS
- SITE PLANS AND DRAWINGS
- EQUIPMENT INVENTORY

#### **HVAC EQUIPMENT DESCRIPTIONS AND SEQUENCES OF OPERATION**

- PENTHOUSE MECHANICAL ROOMS
- PENTHOUSE AIRHANDLERS
- MAIN AIR HANDLERS

#### **ELECTRICAL DISTRIBUTION AND SPECIFICATIONS**

- EMERGENCY GENERATORS
- MAIN ELECTRICAL SUBSTATIONS
- ADDITIONAL SUBSTATIONS
- LIGHTING CONTROL SYSTEMS
- TRANSFORMERS

#### **ENERGY MANAGEMENT CONTROLS AND SPECIFICATIONS**

- BUILDING AUTOMATION SYSTEM
- DUAL DUCT VAV TERMINALS
- COOLING VAV TERMINALS
- UTILITY CURTAILMENT

#### **ARCHITECTURAL AND STRUCTURAL SYSTEM MAINTENANCE**

- FAÇADES
- ROOFS
- PARKING DECKS
- RAIN GUTTERS
- DRAINS
- WINDOWS
- VERTICAL TRANSPORTATION (ELEVATORS/ESCALATORS)

#### **CUSTODIAL OPERATIONS AND GROUNDS MAINTENANCE**

- LANDSCAPE MAINTENANCE
- PEST CONTROL
- TRASH
- SNOW REMOVAL
- BUILDING CLEANING
- PARKING LOTS

#### **TOUR PROCEDURES AND MAINTENANCE DOCUMENTATION**

- TOUR PROCEDURES
- DAILY CHECKLIST

WEEKLY CHECKLIST  
SCHEDULED MAINTENANCE  
CORRECTIVE MAINTENANCE AND REPAIRS  
PLANNED PREVENTIVE MAINTENANCE

**SERVICE CALL, MAINTENANCE AND REPAIR PROCEDURES**

TENANT REQUEST AND SERVICE CALLS  
AFTER-HOURS CALLS  
EMERGENCY SERVICE CALLS

**BUILDING SECURITY PROCEDURES**

ACCESS AND IDENTIFICATION  
MONITORING  
BAGGAGE INSPECTIONS  
LOADING DOCK ACCESS  
PARKING LOT ACCESS  
AFTER-HOURS ACCESS  
PATROLS  
REPORTING INCIDENTS AND RESPONDING TO EMERGENCIES  
FIRE INCIDENT INVESTIGATIONS  
SIGNAGE

**EMERGENCY PLANS AND HAZMAT PROCEDURES AND CONTINGENCY PLANS**

SHELTER IN PLACE LOCATIONS  
BUILDING EVACUATION ROUTES AND MEETING PLACES  
BOMB AND BIOHAZARD CONDITIONS, SYSTEMS SHUTDOWN PROCEDURES  
ELEVATOR EMERGENCY PROCEDURES  
FIRE EXTINGUISHER, DEFIBRILLATOR, AND PULL SWITCH LOCATIONS  
ASBESTOS MANAGEMENT  
HAZARDOUS MATERIAL AND HAZMAT WASTE MANAGEMENT  
UNDERGROUND STORAGE TANKS  
LEAD PAINT MANAGEMENT  
ENERGY LOAD CURTAILMENT PLANS  
WATER CURTAILMENT PLANS  
LOSS OF PERSONNEL  
EMERGENCY NUMBERS  
DISASTER AND RECOVERY PROCEDURES  
FIRE PUMPS  
SUMP PUMPS  
SEWAGE EJECTOR PUMPS  
PRESSURE BOOSTERS  
PRESSURE REDUCING STATIONS  
BACKFLOW PREVENTOR  
ALL MAIN SHUT OFF LOCATIONS AND PROTOCOL

## **Appendix B – Operation, Maintenance and Repair Responsibilities**

The delegated Agency's operation, maintenance and repair responsibilities are equivalent to those aspects of operation, maintenance and repair that a private-sector landlord provides to a tenant. Day-to-day building operation includes scheduled repetitive work such as cleaning and janitorial services, groundskeeping and site maintenance, administration, and building maintenance (preventive, routine and unscheduled) and repairs.

Preventive and routine maintenance includes, but is not limited to, inspection and servicing of exterior apertures (*i.e.*, windows, doors, shutters), fire doors, conveying systems (*i.e.*, elevators, wheelchair lifts, escalators), and plumbing and mechanical systems (*i.e.*, heating, fuel storage tanks, air-conditioning, fire and safety). For HVAC systems, the following tasks are considered preventive and routine maintenance: annual start-up; system balancing; periodic filter change; motor, fan and compressor lubrication; and fan, motor and compressor replacement.

Unscheduled maintenance is any action required to restore service to systems that have failed or shut down. Immediate action is required to resolve problems that will interrupt business activities or create hazards to personnel, equipment or the environment. Examples of situations that might require unscheduled maintenance include, but are not limited to, loss of heating or refrigeration, elevator failure, electrical power or water supply loss, and flooding.

Repair that requires replacements that do not increase the value or prolong the useful life of an asset are considered repair expenses. Examples are purchasing small parts to keep machinery in normal working condition, replacing HVAC components that do not last beyond the original equipment's useful life or resealing a parking lot to maintain it in normal working condition until the original useful life expires.

GSA retains responsibility for plant and equipment system replacement deemed necessary by BERs and asset business plans. The replacement of a part or minor component of a system, *e.g.*, a compressor or a fan, is considered a repair. The replacement of the entire system or major equipment, *e.g.*, entire chiller, is a capital improvement.

The items below are presented as examples only and are not to be construed as an exhaustive listing of Agency and GSA responsibilities.

Item	<b>Delegated Agency Maintenance and Repair Responsibilities</b> (Items Typically Expensed to Tenants by Private Sector Landlords)	<b>GSA Capital Replacement and Modernization Responsibilities</b>
<b>Exterior Systems</b>	<ul style="list-style-type: none"> <li>▪ Clean, maintain and repair exterior stairs, exterior doors, exterior window systems, atriums, exterior lighting and hardware, caulking, and weather stripping.</li> <li>▪ Perform exterior painting and caulking.</li> <li>▪ Replace broken window glass and any window components that are missing or have failed.</li> <li>▪ Regularly inspect masonry pointing and notify GSA of any deterioration. Maintain and repair masonry systems.</li> <li>▪ Regular inspections of entire building envelope. Prevent water infiltration into building with proper corrective action.</li> <li>▪ Maintain waterproofing and caulking on and around plazas, decks, planters, underground vaults, and other structures, including their membranes, substrates, drains, and vents.</li> <li>▪ Maintain, repair and seal, as necessary, surface and undersurface of parking decks, curbs and sidewalks.</li> </ul>	<ul style="list-style-type: none"> <li>▪ Major cleaning, re-pointing and repairing exterior structural walls.</li> <li>▪ Major repair of exterior openings and permanent interior partitions.</li> <li>▪ Replace structural elements, e.g., stair towers.</li> <li>▪ Replace all windows.</li> <li>▪ Special circumstances may require refinish and repair decorative and architectural metals, including doors and associated trim, grills, gates, lighting fixtures, and hand rails. (To be identified in Interagency Agreement.)</li> <li>▪ Replace plazas, decks and planters of an architectural nature, parking decks, above underground vaults, or other structures.</li> <li>▪ Replace entire parking deck surface.</li> </ul>



Item	Delegated Agency Maintenance and Repair Responsibilities (Items Typically Expensed to Tenants by Private Sector Landlords)	GSA Capital Replacement and Modernization Responsibilities
Roofing	<ul style="list-style-type: none"> <li>▪ Collect and maintain roof data electronically. One suggested program software is ROOFER developed by the U.S. Army Corps of Engineers.</li> <li>▪ Follow manufacturer's requirements to maintain warranty coverage. Verify repairs to be completed under a warranty.</li> <li>▪ Inspect roof at least twice a year, once after the hottest weather and again after the coldest weather. Also, after any major weather event. Document inspection.</li> <li>▪ Remove debris and sharp objects immediately.</li> <li>▪ Trim overhanging tree branches.</li> <li>▪ Ensure drain covers, gutters and downspouts are unclogged and scupper openings are clear of debris.</li> <li>▪ Ensure proper slope for roof and gutter drainage.</li> <li>▪ Inspect coatings on roof membrane, seams, laps, and flashings for separation, blisters and exposure. Ensure tight and proper bonding.</li> <li>▪ Check for cracked or missing flexible sealant at walls and penetrations. Secure loose and replace missing fasteners.</li> <li>▪ Check metal roof systems and panel seams for loose fasteners, ponding and corrosion.</li> <li>▪ Perform all repair work through qualified roofing personnel in accordance with the recommendations of the roof system manufacturer and the National Roofing Contractors Association.</li> </ul>	<ul style="list-style-type: none"> <li>▪ Replace roof, in whole or in part, when it has reached the end of its useful life, as determined by a professional roofing consultant, or as otherwise identified in the GSA BER process. Either GSA or the Agency may hire the roof consultant.</li> </ul>

Item	<b>Delegated Agency Maintenance and Repair Responsibilities</b> (Items Typically Expensed to Tenants by Private Sector Landlords)	<b>GSA Capital Replacement and Modernization Responsibilities</b>
<b>Fire Protection and Life Safety Systems</b>	<ul style="list-style-type: none"> <li>▪ Test, inspect, maintain, and repair all fire protection systems, emergency power systems, and life safety systems within the building in accordance with nationally recognized codes and standards.</li> <li>▪ Ensure all modifications to fire protection and life safety systems are performed by qualified, licensed technicians (e.g., NICET Level 2 or higher).</li> <li>▪ Maintain and repair fire alarm systems, in accordance with the requirements of the NFPA 72, National Fire Alarm Code.</li> <li>▪ Maintain all automatic fire sprinkler systems in accordance with the requirements of the NFPA 25, Standard for the Inspection, Testing, and Maintenance of Water-based Fire Protection Systems.</li> <li>▪ Perform fire pump testing per NFPA.</li> <li>▪ Ensure all fire protection systems transmit alarm, supervisory and trouble signals to a UL-listed central station. The Agency must provide and maintain two phone lines next to the fire alarm system's main control panel for this purpose.</li> <li>▪ Provide system monitoring where unavailable from GSA Regional Emergency and Control System.</li> <li>▪ Provide fire extinguishers and maintain currently installed special suppression systems.</li> </ul>	<ul style="list-style-type: none"> <li>▪ Replace fire alarm and sprinkler systems, based on BER, fire protection inspections, and asset business plans that are completed by GSA.</li> </ul> <p><b>NCR-DESIGNATED BUILDINGS ONLY USING GSA SERVICES.</b></p> <ul style="list-style-type: none"> <li>▪ Test, inspect (preventative maintenance), maintain, and repair all fire alarm systems within the building in accordance with nationally recognized codes and standards.</li> <li>▪ Ensure all fire protection systems transmit alarm, supervisory and trouble signals to a UL-listed central station or the DHS/FPS Regional Emergency Management Control Center, or both. NOTE: The Agency must provide and maintain two phone lines next to the fire alarm system's main control panel for this purpose.</li> <li>▪ Replace fire alarm, fire pump, sprinkler systems, and emergency power systems.</li> </ul>

Item	Delegated Agency Maintenance and Repair Responsibilities (Items Typically Expensed to Tenants by Private Sector Landlords)	GSA Capital Replacement and Modernization Responsibilities
<b>Interior Systems</b>	<ul style="list-style-type: none"> <li>▪ Maintain, repair and replace partitions, including demountable and toilet partitions.</li> <li>▪ Maintain and repair interior trim.</li> <li>▪ Maintain interior doors, hardware and interior stairs.</li> <li>▪ Maintain, repair and replace wall finishes, flooring and floor finishes, and ceilings and ceiling finishes.</li> <li>▪ Plan, supervise and fund Agency tenant alterations.</li> <li>▪ Perform interior painting.</li> <li>▪ Maintain asbestos encapsulation or abatement program.</li> </ul>	<ul style="list-style-type: none"> <li>▪ Plan, design and fund total replacement of interior components, as determined necessary by inspection and asset business planning.</li> <li>▪ Maintain and preserve decorative architectural elements.</li> <li>▪ Maintain and preserve artwork provided by GSA.</li> </ul>
<b>Mechanical Systems</b>	<ul style="list-style-type: none"> <li>▪ Follow manufacturer's requirements for routine maintenance of all heating and cooling equipment.</li> <li>▪ Maintain and repair HVAC primary and secondary systems, such as air handling units, perimeter fan coil units, cooling coils, heating coils, and control systems, and replace parts of such systems and subsystems, as necessary.</li> <li>▪ Repair or replace incidental pipe failure and failed plumbing fixtures.</li> <li>▪ All testing and balancing.</li> </ul>	<ul style="list-style-type: none"> <li>▪ Replace entire HVAC or complete major components, e.g., boilers, chillers, and air handling unit.</li> <li>▪ Replace plumbing system or a significant portion, e.g., systemic pipe failure in all or part of the building.</li> <li>▪ Replace exterior water mains.</li> </ul>
<b>Elevators and Escalators</b>	<ul style="list-style-type: none"> <li>▪ Perform regular maintenance and repair in accordance with manufacturer's guidelines.</li> </ul>	<ul style="list-style-type: none"> <li>▪ Perform mandated upgrades and whole system replacements, when determined necessary by inspection and asset business planning.</li> </ul>

Item	Delegated Agency Maintenance and Repair Responsibilities (Items Typically Expensed to Tenants by Private Sector Landlords)	GSA Capital Replacement and Modernization Responsibilities
<b>Electrical Systems</b>	<ul style="list-style-type: none"> <li>▪ Maintain electrical subsystems, such as electrical transformers and high-tension switchgear, primary switchgear, secondary switchgear, motor control centers, branch circuit panel boards, branch circuit wiring systems, and lighting systems.</li> <li>▪ Maintain and repair service and distribution systems, power systems, lighting fixtures, and electrical service ground systems, including wiring repairs and circuit breaker maintenance.</li> <li>▪ Provide for the replacement and proper disposal of lamps, ballasts, and PCB-containing equipment, <i>e.g.</i>, light ballast capacitors.</li> <li>▪ Test, inspect, maintain, and repair emergency power systems.</li> </ul>	<ul style="list-style-type: none"> <li>▪ Replace electrical subsystems, such as primary switch gear, secondary switch gear, motor control centers, branch circuit panel boards, branch circuit wiring system, and lighting systems, as determined necessary by inspection and asset business planning.</li> <li>▪ Replace and upgrade entire electrical and power systems, as determined necessary by inspection and asset business planning.</li> <li>▪ Replace emergency power systems.</li> </ul> <p><b>NCR-DESIGNATED BUILDINGS ONLY USING GSA SERVICES.</b></p> <ul style="list-style-type: none"> <li>▪ The GSA Special Services Switchgear Shop maintains all high voltage and low voltage switchgear equipment, with the exception of low voltage disconnect switches rated below 200 amps, molded case breakers rated below 400 amps, regardless of the voltage, dry type transformers 30 KVA and below, motor controllers below 200 hp, and motors below 200 hp.</li> </ul>

Item	Delegated Agency Maintenance and Repair Responsibilities (Items Typically Expensed to Tenants by Private Sector Landlords)	GSA Capital Replacement and Modernization Responsibilities
<b>Site Work and Parking</b>	<ul style="list-style-type: none"> <li>▪ Maintain and repair fencing.</li> <li>▪ Maintain USTs.</li> <li>▪ Perform cleanup and remedial action for environmental problems related to use and occupancy.</li> <li>▪ Repair and maintain parking lots, including resealing, striping and catch basin repair.</li> <li>▪ Maintain and repair parking decks and plaza decks.</li> <li>▪ Maintain roads and walkways, including driveways, service drives and sidewalks.</li> <li>▪ Maintain caulking, patching and cold patching of cracks, as required, to prevent or stop leaks.</li> </ul> <p>(GSA and the Agency may utilize appropriate consultants to evaluate replacement or repair conditions of parking surface, plazas, and other roads and walkways)</p>	<ul style="list-style-type: none"> <li>▪ Remove existing USTs, if required by environmental regulations. (If the tank was installed by GSA, GSA is responsible. If the tank was installed by the Agency, the Agency is responsible.)</li> <li>▪ Perform required environmental cleanup and remedial action not related to occupant's use and occupancy.</li> <li>▪ Perform required seismic retrofit actions.</li> <li>▪ Replace entire parking lots, parking decks, plazas, and sidewalks, as indicated by inspection and asset business planning.</li> </ul>
<b>Grounds and Landscape</b>	<p>Provide routine maintenance, <i>e.g.</i>, fertilization, lawn, shrub, and tree care, and dead bush and tree removal and replacement. Replace lost vegetation and dispose of yard waste, as necessary. Repair and replace sprinkler heads and water supply lines. Maintain flagpoles and flags.</p>	<p>Install initial landscaping and related sprinkler systems.</p>
<b>Child Care</b>	<p>Clean, maintain, repair, and replace all equipment, including classroom furnishings and equipment (this includes, but is not limited to, tables, chairs, cribs, strollers, high chairs, changing tables, bookshelves, playground equipment, and laundry and kitchen appliances), unless otherwise specified in this delegation.</p>	<p>Replace playground surface and playground equipment at the end of its useful life.</p>
<b>Cafeteria</b>	<p>Repair, replacement and renovation of food service equipment in either a full or partial delegation.</p>	<p>Equipment replacement as part of complete space renovation.</p>

## Glossary

**ABAAS** - Architectural Barriers Act Accessibility Standard

**ABT** – Asset Business Team

**ACM** – asbestos-containing material

**ADA** – Americans with Disabilities Act

**Agency** – the agency that the GSA Administrator has delegated to perform some type of building operation and maintenance or alteration

**BER** – Building Engineering Report

**BOP** – Building Operating Plan

**building** – GSA-controlled building, facility, or other real property

**CAD** – computer-aided design

**CFCs** – chlorofluorocarbons

**CFR** – Code of Federal Regulations

**CMMS** – computerized maintenance management system

**CO** – contracting officer

**DHS/FPS** – Department of Homeland Security Federal Protective Service

**EPA** – Environmental Protection Agency

**ESPC** – Energy Savings Performance Contracting

**GSA** – General Services Administration

**HOTD** – GSA Heating, Operation, and Transmission District

**HVAC** – heating, ventilating and air conditioning

**LBP** – lead-based paint

**NAEYC** – National Association for the Education of Young Children

**NCR** – National Capital Region (Region 11)

**NFPA** – National Fire Protection Association

**NICET** – National Institute for Certification in Engineering Technologies

**O&M** – operations and maintenance

**OA** – Occupancy Agreement

**OEP** – Occupant Emergency Plan

**OSHA** – Occupational Safety and Health Administration

**PBS** – GSA's Public Buildings Service

**PCBs** – polychlorinated biphenyls

**PCS** – Physical Condition Survey

**PM** – preventive maintenance

**RF** – radio frequency

**RHPO** – regional historic preservation officer

**RWA** – Reimbursable Work Authorization

**SOP** – Standard Operating Procedures

**U.S.C.** – United States Code

**UL** – Underwriters Laboratory

**UST** – underground storage tank

**EXHIBIT B**  
**Facility Management Plan**

**PROPOSED  
FACILITY MANAGEMENT PLAN  
U.S. Nuclear Regulatory Commission**

Rockville, Maryland

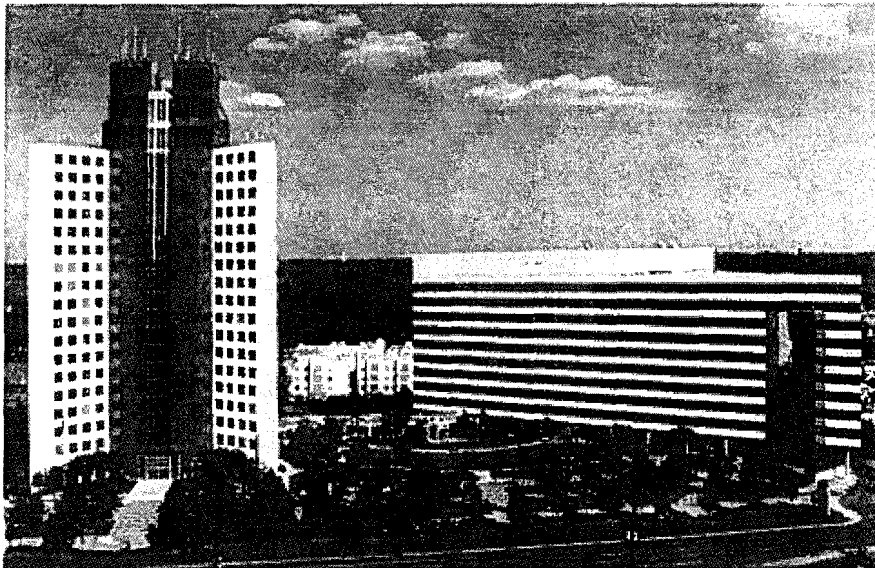

One White Flint North  
Facility Operations  
Workplace Services  
Internal Business Services

December 2010

Enclosure



## Table of Contents

1.	<b>Purpose</b> .....	1
2.	<b>Background</b> .....	1
3.	<b>Building Description</b> .....	2
4.	<b>Overview of NRC Facility Management Program</b> .....	2
5.	<b>Shared Vision</b> .....	3
6.	<b>Tactical Plan (Narratives)</b> .....	5
7.	<b>Contractor Operating Plans</b> .....	9
8.	<b>References</b> .....	26
9.	<b>Signature Page</b> .....	27

**Facility Management Plan  
U.S. Nuclear Regulatory Commission  
11555 Rockville Pike  
Rockville, MD 20852-2738**

**1. PURPOSE**

This document is intended to specify the management procedures, enhance service delivery and provide for efficiency in the management of the General Services Administration (GSA) facility and adhered to by the U.S. Nuclear Regulatory Commission (NRC). The NRC Facility Management group will assure that NRC complies with the terms of the Delegation of Authority (DOA) that allows the agency to operate and maintain the 11555 Rockville Pike facility located in Rockville, Maryland in a condition that meets the expectations of the GSA. This document further establishes the shared vision of GSA and NRC as it pertains to individual functional areas required to efficiently manage a Federal government facility.

**2. BACKGROUND**

NRC has operated and maintained the building located at 11555 Rockville Pike in Rockville, MD 20852, under a DOA from the GSA. The key responsibilities assigned to NRC under the DOA include:

- A. cleaning;
- B. operating and maintaining the building;
- C. ordering and paying for utilities;
- D. altering space, including abatement work, if necessary. For alterations in excess of \$100,000, the agency must obtain GSA's consent.
- E. operating and maintaining the fire and life safety equipment;
- F. providing concessions services through a full concessions delegation; and
- G. assigning space in areas occupied by the agency

According to the DOA, GSA retains certain responsibilities in government-owned space. These responsibilities include:

- A. periodically assessing agency stewardship, overall physical condition of the building, and the agency's ability to deliver services;
- B. capital building improvements, equipment replacement and modernization projects over \$1,000,000; and
- C. preparing and submitting required prospectuses for congressional approval, with the agency's input.

The DOA specifies that GSA will use a quality assurance program to monitor the agency's performance. The quality assurance program consists of three key elements:

- A. Customer Satisfaction – customer feedback;
- B. Building Evaluation Reports (BER) – conducted periodically by approved GSA contractors in cooperation with NRC to assess overall building condition and identify deficiencies. The BER may become the basis for GSA remedial action plans and budget submissions.

- C. Operational Reviews -- to be conducted periodically by GSA to assess the condition of the building systems and equipment and evaluate the agency's preventive maintenance (PM) program and records.

The GSA Standard Operating Procedures for the Operation and Maintenance (O&M) of Delegated Real Property state that:

"The Agency shall develop and administer a Facility Management (FM) program that results in the efficient and effective operation and maintenance of all interior and exterior building systems and related equipment. . ." The FM program must also contain a system for inspecting and documenting proper delivery of all services as well as procedures and processes that provide management with a high level of confidence in proper program execution."

### 3. BUILDING DESCRIPTION

The NRC One White Flint North building houses approximately 1,800 employees and contractors. The building consists of 18 floors and a parking garage. The building measures approximately 645,302 gross square feet, the rentable area is approximately 480,316 square feet, and the useable area is 310,448 square feet.

The building consists of Federal government office space, a cafeteria, and 472 underground parking spaces that support the building.

### 4. OVERVIEW OF NRC FACILITY MANAGEMENT PROGRAM

The NRC Facility Operations Team has overall responsibility for planning, budgeting, and managing expenditures related to the operation of the building. The team is also responsible for a comprehensive quality control system to ensure that the building is maintained in a way that maximizes its life expectancy.

Day-to-day facility operations have been provided through a consolidated facility management (CFM) contract with an outside vendor. The CFM contract is re-competed on a regular basis. The statement of work (SOW) for the CFM contract was designed as much as possible to be a "performance-based" specification, rather than a prescriptive one. For example, the SOW requires the contractor to maintain the building systems in sound, operational condition, instead of stating detailed inspection and repair instructions. The NRC oversight role focuses on results or outcomes, not processes.

In addition to providing on-site facility management services, the CFM is responsible for maintaining the Computerized Maintenance Management System (CMMS). The CMMS is the repository for the PM program, including equipment history, inspection schedules and records, and workload tracking.

5. SHARED VISION OF FUNCTIONAL/OPERATIONAL AREAS OF ONE WHITE FLINT NORTH

5.1 Landscaping/Snow Removal

NRC is responsible for maintaining an established landscaping/snow removal program to provide a clean, healthy and attractive environment, and to preserve and protect exterior finishes.

5.2 Custodial

5.2.A Cleaning/Pest Control

NRC is responsible for establishing and maintaining cleaning and pest control management programs to provide a clean, healthy and attractive environment, and to preserve and protect interior finishes.

5.2.B Recycling

NRC has implemented a plan to maximize the collection of recyclable materials in accordance with established government policies and good business practices.

5.3 Service Contracts

NRC is responsible for initiating contracts for necessary services in accordance with established government policies and good business practices.

5.4 Building Service Calls

NRC has established a building service call process to ensure timely response and appropriate corrective action to requests.

5.5 Operation and Maintenance

O&M will be primarily under the control of NRC.

5.6 Utility/Energy Conservation

NRC will have overall responsibility for energy conservation. NRC has developed a plan to meet the Presidential executive orders related to reductions in energy usage.

5.7 Health and Safety

NRC understands and agrees that the health and safety of tenants, workers, and visitors is of paramount importance and the shared responsibility of both agencies.

5.8 Space Utilization

NRC is responsible for maintaining an established space utilization program. NRC will be responsible for monitoring space utilization in accordance with the Federal Management Regulation (FMR) 2005-3, Subchapter C, Part 102-79, as long as it is applicable, or any succeeding national standards/regulations.

5.9 Reimbursable Repairs and Alterations

NRC has developed and implemented a proactive repair and alteration program.

5.10 Concessions/Cafeteria

NRC will have overall responsibility for the concession/vending and cafeteria programs. NRC will promote the effective utilization of the cafeteria and concession program in order to maintain a productive working environment for the facility's tenants.

5.11 Child Care

NRC will maintain the structure of the child care center and playground and provide upgrades as required by changing laws.

5.12 Acceptance

All work to be performed in the building or on the grounds will be coordinated with GSA where possible. All pertinent paperwork will be forwarded to GSA for review and acceptance.

5.13 Budget Administration

GSA and NRC will jointly develop a procedure to oversee the administration of the budget program relating to such rent payments.

5.14 Training

NRC has developed a training program to prepare the assigned agency employees to perform all of the activities needed to carry out the vision and goals of this facility management plan.

5.15 Duration of FM Plan

The initial development of this FM Plan commenced on November 22, 2010. Any or all responsibilities may be terminated by GSA and/or NRC upon 120 days notice, if it is determined to be in the best interest of the government. Otherwise, this plan will remain in effect indefinitely.

5.16 Funds

Annual operating plans will be established between GSA and NRC, the purpose of which is to identify the services and associated costs necessary to effectively and efficiently operate the facility while remaining in conformance with applicable laws and regulations.

5.17 Duplication

Full implementation of this FM Plan will not duplicate any existing agreement.

6. TACTICAL PLAN/NARRATIVES

6.1.A Landscaping

1. The NRC staff will serve as the contracting officer technical representative (COTR) and is responsible for:
  - A. maintaining an established landscaping program;
  - B. providing a clean, healthy and attractive environment; and
  - C. preserving and protecting the exterior finishes.

6.1.B Snow Removal

1. The NRC is responsible for maintaining an established snow removal program.
2. The NRC PO will serve as the COTR and is responsible for obligating funds and amending/modifying the contract.
3. The NRC PO is responsible for interpreting/evaluating specifications, issuing orders against the contract, monitoring, inspecting and accepting performance.
4. The NRC PO has developed internal operating procedures to ensure timely response and corrective actions to complaints.
5. The NRC PO has established an inspection program for snow removal to ensure that snow is cleared satisfactorily and other scheduled services are provided.

6. A copy of all contracts, including amendments, modifications, and reports or documentation of reported concerns/incidents service plans will be shared with the GSA.

## 6.2 Custodial

### 6.2.A Cleaning/Pest Control

1. The NRC PO has developed janitorial/pest control reporting procedures in conjunction with the building service call process to ensure timely response and corrective action.
2. The NRC PO has established an inspection program for janitorial services/pest management to ensure that the buildings are cleaned properly and maintained (free of any pest infestation), and that scheduled services are provided.
3. The NRC PO has established an integrated pest management program. All pest applications should meet Environmental Protection Agency (EPA) National Institute of Occupational Safety and Health (NIOSH) guidelines and should be applied after hours to assure a safe environment for all occupants.
4. The agencies (GSA and NRC) agree to share copies of all contracts (including amendments and modifications, service plans, any reported pest or safety concerns, reports or documentation of reported concerns/incidents of pest application, preventive control and pest management.

### 6.2.B Recycling

The NRC is responsible for maintaining an established recycling program.

## 6.3 Service Contracts

1. The NRC PO will obligate funds, amend/modify contracts, interpret/evaluate specifications and issue orders against service contracts. Such contracts may consist of: medical and hazardous waste removal, locksmith, carpet installation, carpet and/or upholstery cleaning, furniture installs, public announcement, telephone and data/communication services. NRC has specific authority for requesting and ordering services utilizing NRC funds.
2. The NRC PO has established an inspection program for services to ensure that scheduled services are satisfactorily provided. A Form GSA-220 or other acceptance document will be completed and filed after each job.

3. Reports or documentation of reported concerns/incidents will be shared. NRC will maintain a service contract for locksmith services relative to internal needs such as desks and file cabinets.

#### 6.4 Building Service Calls

1. The NRC has provided employees with a computerized system and a centralized number to use for reporting building operations concerns/problems. Calls will be handled by the Customer Service Desk.
2. Based on the nature of the calls, the O&M contractor refers services calls to the appropriate NRC staff for corrective action.
3. The NRC PO monitors, documents and tracks calls. Calls are analyzed individually and collectively to identify repetitive problems which may be indicative of unsatisfactory services.
4. The NRC is maintaining a system for building services requests, which does allow staff to determine patterns/history of issues/problems.
5. The O&M contractor will have inspection responsibilities regarding building services. Contractors will self-certify with NRC PO concurrence.

#### 6.5 Building Operations and Maintenance

The NRC is responsible for establishing and maintaining a building O&M program. The NRC PO serves as the COTR. The NRC PO has established an inspection program for services to ensure that scheduled services are satisfactorily provided. A copy of all contracts, including amendments and any other pertinent information, will be shared with the GSA upon request.

#### 6.6 Utility/Energy Conservation

The NRC has primary control of the complex. Energy tracking will be closely tied to the operation and maintenance of the building; therefore, these two plans are tied together.

#### 6.7 Health and Safety

##### 6.7.A Environmental Health

1. The NRC will provide environmental monitoring and survey services to be used in its Federal government-owned or leased space.



2. The NRC will have specific authority for requesting and ordering environmental monitoring and survey services utilizing NRC funds.
3. The request for services will be approved and authorized by the NRC COTR. Testing results will be reviewed and shared with all concerned parties and an appropriate action plan will be provided, if required, to eliminate environmental, health or safety issues.
4. The NRC will provide testing results to GSA for the purpose of resolving and/or eliminating the environmental, health or safety issues. A GSA/NRC partnership will be used to discuss, evaluate and prepare an action plan, if required, to eliminate the environmental, health or safety issues.

#### 6.7.B Safety

1. The NRC shall provide GSA with copies of major building inspections for the purpose of identifying and correcting any safety violations in tenant space.
2. GSA has the authority to request that NRC immediately correct safety violations, if that violation is an immediate concern to the safety or health of individuals or to Federal government property. NRC will correct any safety violation relating to the building since they have overall responsibility.
3. The NRC will establish a monitoring program to ensure that all employees, contractors, and visitors are protected from safety or health issues that may arise.

#### 6.8 Space Utilization

The NRC is responsible for maintaining an established space utilization program.

#### 6.9 Reimbursable Repair and Alteration

The NRC is responsible for maintaining an established repair and alteration program.

#### 6.10 Computer Aided Design System

Section 13 describes the relationship and responsibilities between GSA/NRC regarding the Computer Aided Design System (CAD/APERTURE).

6.11 Concessions/Cafeteria

1. The NRC will ensure that cafeteria and vending services are provided, in compliance with local, state, and Federal regulations and laws.
2. All contract actions, including amendments, modifications, reports or documentation, and service plans will be shared with the GSA.

6.12 Child Care

The NRC assures that the child care designated space is maintained in compliance with local, state and Federal guidelines and laws. The contract for the child care program is handled by an independent outside contractor, through the oversight of an independent Board, with no program involvement from GSA or NRC.

6.13 Flags and Flagpoles

The NRC site has a guard services contractor to raise and lower the flags. The O&M contractor will handle the repair and maintenance of flagpoles.

6.14 Tactical and Operating Plans Reviews

The tactical and operating plans can be entered into, amended, or modified by either agency (GSA or NRC). The tactical plan should be reviewed as needed; but not less frequently than the anniversary date of the most recently revised plan. The operating plans should be reviewed and updated as needed.

7. CONTRACTOR OPERATING PLANS REQUIREMENTS

7.1 LANDSCAPING OPERATING PLAN

7.1.A General

1. The contractor shall furnish all necessary labor, materials, supplies, equipment, and supervision to perform mowing, trimming, edging and chemical application to turf areas, as well as mulching, pruning, fertilizing, and weed and insect control of all plants and planting beds.

7.1.B Scheduling of Work

1. Service shall be performed as scheduled or when ordered by the NRC PO.
2. Service will be ordered by telephone and confirmed by email. The contractor shall furnish the NRC PO with a list of telephone numbers

where either the contractor's site manager or his authorized representative may be contacted.

3. The NRC PO may request that the contractor perform corrective, special or emergency services.

#### 7.1.C Equipment and Materials

1. Prior to beginning work, the NRC PO shall approve the contractor's list of all equipment; materials; frequency schedules; Material Safety Data Sheets (MSDS), and manufacturer's cautions, warnings, recommended application procedures and mixing rates.
2. The NRC PO must ensure that the contractor complies with all requirements of the Federal Insecticide, Fungicide and Rodenticide Pesticide Act of 1972, Public Law 92-516 as well as all state and local health/safety regulations.
3. All work to be done in the building or on the grounds will first be authorized and approved by the NRC PO. All pertinent paperwork will be forwarded for the NRC PO review in advance of the procurement. The NRC PO will establish an inspection program for services to ensure that scheduled services are satisfactorily provided.

### 7.2 SNOW REMOVAL OPERATING PLAN

#### 7.2.A General

1. The contractor shall provide all management, supervision, labor, materials, supplies (must receive prior approval from the NRC PO concerning type, price and quantity of materials and supplies) and equipment to perform snow and/or ice removal services in a satisfactory and timely manner (the term "timely" means before the official opening of the buildings). The Contractor shall be provided with storage for a sufficient amount of supplies to handle at least one snow/ice storm.
2. Contract shall provide the NRC PO with an hourly rate schedule and charges for equipment.
3. A contractor must have appropriate equipment.
4. The contractor shall plan, schedule, coordinate, and assure effective completion of all services. In the event of "blizzard conditions" or a heavy snowfall, the contractor will keep all entrances, driveways, fire lanes, and building entrances open and passable.

5. The contractor must be familiar with various snow and ice removal methods, including sanding and salting. Material used for de-icing shall be non-destructive and in-injurious to parking lot pavements, sidewalks, ramps, stairways, lawns, trees, shrubbery, ivy beds, and ground cover. Material will comply with all Federal, state and local regulations. Snow removal will be performed on a time and materials basis with appropriate equipment at the rate quoted the previous spring, if requested, by the NRC PO or CO. At the time of award, the contractor should submit the MSDS for review.
6. The contractor must be available on short notice and must respond to the jobsite within 1 hour of being called for service, and start work within 2 hours of being notified. The contractor will not be compensated for travel time or any type of accident while en route. If requested, the contractor shall make subsequent visits to the site to treat ice patches that may refreeze due to wet pavements or standing water.
7. The NRC PO is authorized to place service calls. The contractor should reference the contract number when invoicing.
8. The contractor's employees shall be familiar with location prior to the start of the snow removal operations.
9. The contractor will be liable for any damages to the storm drain inlets, curbs, fire hydrants, parking lots or buildings etc., resulting from snow removal operations. The contractor must coordinate with NRC PO for the proper snow markings. The contractor is to ensure that all snow markers are properly installed and added, where needed, in order to prevent any damage to NRC property.
10. The contractor shall clean snow from all parking lots, driveways, and walks in a manner not to obstruct fire hydrants, fire exits, and building entrances and no snow piles that would impede driving vision. Small hand-operated equipment (i.e., snow shovels, walk-behind snow blowers and plows) shall be used on sidewalks and entrances where needed.

7.2.B Inspection and Acceptance

1. All work under the contract is subject to final inspection/acceptance by the NRC PO. The NRC PO who inspects and accepts contractor work must complete a Form GSA-220 or other acceptance document for the file.

2. The contractor will not receive final payment until all of the requirements of this contract have been completed satisfactorily.
3. The NRC PO acceptances of the work will be based principally on its timely and efficient completion. Given the nature of the work, the NRC cannot provide specific standards of acceptability.

### 7.3 CUSTODIAL OPERATING PLAN

#### 7.3.A General

1. The contractor shall provide management, supervision, manpower, equipment and supplies necessary to provide janitorial and pest control services.
2. All work shall be subject to inspection and approval by the NRC PO.
3. The NRC PO will ensure that the work or supplies are inspected to ensure compliance with contract requirements.
4. The NRC PO will authorize payment for satisfactory work performed.
5. Based on NRC inspection reports, the NRC CO will be advised when the contractor fails to begin work or deliver services in accordance with the contract.
6. The NRC PO will initiate requests for contract amendments and forward those to the CO. The NRC PO will ensure that all appropriate amendments/modifications to the contract are initiated.

#### 7.3.B Scheduling of Work

1. Services shall be performed as specified in the contract or when ordered by the NRC PO. Above standard services may be purchased.
2. The NRC may order services through the agency Cleanit service request, telephone or in writing. Contractor will provide the NRC PO with a list of telephone numbers for emergency contacts for day time and/or after hours emergency situations.

#### 7.3.C Time of Performance

1. Daytime cleaning will take place between 6:00 a.m. and 6:00 p.m. Normal cleaning services shall be performed after 6:00 p.m. within the normal 5-day week, excluding Federal holidays.

2. The NRC PO shall approve contractor requests for work on the weekends.

#### 7.3.D Supplies, Materials, Equipment and Utilities

1. The NRC PO shall receive/approve the contractor's list giving the name of the manufacturer, the brand name and intended use of each of the materials or supplies he proposes to use in the performance of the work as well as a list of equipment.
2. All MSDS shall be provided to the NRC PO for all materials prior to their usage or storage on government property.
3. The NRC PO must ensure that all materials meet Federal specifications, as well as local and state safety and health regulations. All chemicals, compounds, etc., used should be Environmental Quality Program/OSHA approved and should conform to manufacturer or industry standards.

#### 7.3.E Supervision of Work

1. All contract work shall be supervised by on-site contract supervisors who will work with the NRC PO in all phases of progress and results.
2. The contractor shall provide the names and telephone numbers of all the on-site supervisors to the NRC PO.
3. Inspections will be documented, shared, and kept on file.

### 7.4 PEST CONTROL OPERATING PLAN

#### 7.4.A General

1. The contractor shall furnish all supervision, labor, materials and equipment necessary to accomplish the surveillance, trapping and pesticide application components of the Integrated Pest Management Program.
2. All work shall be subject to inspection by the NRC PO.
3. The NRC PO will authorize payment for satisfactory work performed. The NRC PO will provide written documentation of all pest control concerns.

4. All amendments/modifications to the contract will be initiated by the NRC PO and the NRC PO will maintain copies of all contract documentation.

#### 7.4.B Scheduling of Work

1. Contractor access to building space shall be coordinated by the NRC PO.
2. Service shall be performed as indicated on the Pest Control Plan, or when ordered by the NRC PO.
3. The NRC PO will submit written requests for services. The contractor shall furnish the NRC PO with a list of telephone numbers where either the site contractor manager or his authorized representative may be contacted.
4. The NRC PO may request that the contractor perform corrective, special or emergency services.

#### 7.4.C Work Hours

The contractor shall perform all pest control inspections, applications and treatments during normal tenant occupancy (6:00 a.m. – 6:00 p.m.) except in areas that would interfere with the normal work and activities of the facility.

#### 7.4.D Equipment and Materials

1. Prior to beginning work, the NRC PO shall approve the contractor's list of all materials; Pest Control Plan; MSDS; and manufacturers' cautions, warnings, recommended application procedures and mixing rates.
2. The NRC PO must ensure that the contractor complies with all requirements of the Federal Insecticide, Fungicide and Rodenticide Pesticide Act of 1972 or any revision, Public Law 92-516, as well as local and state safety and health regulations.
3. The NRC PO will ensure that all materials meet Federal specifications. All chemicals, compounds, etc., used should be EPA/OSHA approved and should conform to manufacturer or industry standards.

7.4.E Supervision of Work

1. All work will be supervised by the contractor or his representative who will work with the NRC PO in all phases of progress and results.
2. The NRC PO will evaluate the progress of the contract in terms of effectiveness and safety and all inspections will be documented, shared with GSA upon request, and kept on file.

7.5 RECYCLING OPERATING PLAN

7.5.A General

The purpose of this section is to ensure the collection of as much recyclable material as possible, keep recyclables out of landfills, promote recycling in the workplace, and comply with local, state, and Federal regulations and laws.

7.5.B Recyclable Materials

The term "recyclable materials" shall include, but not be limited to: white paper, mixed paper (all colors and types including newspaper and magazines, corrugated paper (cardboard), glass, plastic, and aluminum cans.

7.5.C Scope of Work

1. Recyclables shall be collected from various areas throughout the complex. The collection containers will be placed in designated locations from which the contractor will remove accumulations of recyclable materials. The majority of these locations will be (but not limited to), corridors, general office space, cafeteria, near photocopiers, and in high activity areas. Locations may be vacated or changed or other locations added, with the actual accumulations of recyclable materials varying in quantity. A priority in determining these locations will be to make the recycling containers accessible to NRC employees.
2. The contractor shall be responsible for moving all of the recyclable materials to an area within the complex, designated by the NRC PO, to be prepared for shipment.
3. The contractor shall be responsible for identifying all recyclable materials by type; paper, newspaper, aluminum cans, etc. All recyclable material will be stored in separate recycling containers.



Paper, newspaper/magazines will be stored separately. Trash and materials other than paper will not be placed in recycling containers.

4. Recyclable materials shall not be handled or moved in any manner that promotes a safety or health hazard.
5. Recycling containers shall be clean and free of residue. Material containers will be emptied prior to overflow of materials.
6. Materials intended to be recycled cannot be placed in a landfill or disposed of in any manner other than recycling.

## 7.6 BUILDING SERVICE CALL PLAN

### 7.6.A General

NRC employees are to report all building related issues/questions through the Fixit service request system, telephone or email to the O&M office.

### 7.6.B Scope of Work

1. The NRC PO will jointly monitor, document and track all building service calls. Each call will be analyzed individually and collectively to identify repetitive problems and determine patterns/history of complaints/problems.
2. The Fixit system will direct service tickets to the O&M contractor and the NRC PO.
3. The NRC PO will provide immediate information to GSA for all building emergency situations.

### 7.6.C Hours of Operation

Maintenance service requests will be responded too daily 6:00 a.m. to 6:00 p.m. After hours Fixit system request will be will be responded to the next business day. All after hour emergency calls are to be directed to the Central Alarm Station (415-2200).

### 7.6.D Supervision

The Fixit system monitoring staff reports directly to O&M contractor.

7.7 BUILDING OPERATION AND MAINTENACE OPERATING PLAN AND UTILITY/ENERGY CONSERVATION OPERATING PLAN

7.7.A General

The purpose of this section is to ensure that the building is operating in a manner that promotes health, safety, and energy conservation while supporting NRC's mission and complying with all Federal regulations.

7.7.B Operating Plan

1. Operation and Maintenance of the facility are primarily under the control of NRC. Technical support is provided by the NRC PO.
2. The NRC PO will establish the building's energy goals and operational guidelines. The NRC PO will track the facility's energy usage and target energy use improvement. NRC will share energy usage data with GSA. The NRC PO will refine the building operating plans as trends in the building's energy use become apparent through building automation system monitoring.
3. The NRC PO will review the contractor's PM program. The NRC PO shall put a program in place to ensure the scheduled PM is being accomplished by contract staff. Inspections shall be performed by the NRC PO. The NRC PO who inspects and accepts contractor work must complete a Form GSA-220 or other acceptable document for the file.
4. Service calls will be received through the Fixit service request system, telephone and email. The NRC PO will establish a quality control procedure to ensure timely correction of problems. In addition, a tracking system has been established by the NRC PO to identify repetitive problems, which may be indicative to the building system.
5. The NRC PO will maintain the permanent property/maintenance records including as-built and shop drawings and will share this information with GSA as needed. Management and control (including any required certifications) of refrigerants, fuel oil, and other hazardous wastes generated by the building systems and equipment will be handled by NRC.

## 7.8 HEALTH and SAFETY OPERATING PLAN

### 7.8.A General Explanations

The purpose of this section is to provide for the safety and health of tenants and visitors and to comply with state/Federal law and regulations. This section will be broken down to include environmental health, hazardous waste, medical waste and safety inspections.

1. The term "contractor" shall refer to that individual, company, or representative whom the NRC has entered into a contract or agreement to perform a service, etc.
2. The term "Contracting Officer" shall refer to that individual who represents the NRC by having primary responsibility for overseeing the contractor's performance.
3. The term "Contracting Officer's Technical Representative" (COTR) shall refer to that individual who represents the NRC by having the primary role of providing technical liaison between the NRC, contractor, user and CO. COTR responsibilities shall include:
  - A. determining whether the contract deliverables meet functional, technical, and performance specifications;
  - B. providing technical advice to the CO for all aspects of contract administration;
  - C. monitoring technical performance; and,
  - D. reporting any potential or actual problems.
4. The term "letter of designation" refers to the authority that the CO gives to the COTR and may, if required, be prepared to assure that all parties agree on their requirements, authority and responsibility.

### 7.8.B Authority/Guidelines

1. The term "Environmental Protection Agency" (EPA) refers to the official government authorities who provide guidelines, laws and regulations relating to environmental issues.
2. The term "Occupational Safety and Health Administration" (OSHA) refers to the official government authority which provides guidelines, laws and regulations providing for the occupational safety and health of employees and enforces standards for workplace health and safety.
3. The term "American Industrial Hygiene Association" (AIHA) and "American Conference of Government Industrial Hygienists" (ACGIH)

are organizations which provide valuable information on all aspects of environmental and industrial health and worker safety.

4. The term "American National Standards Institute" (ANSI) and the "Code of Federal Regulations" (CFR) will be used to provide standards, rules, regulations and interpretations of those laws for protecting employees which will be followed and adhered to by the government.

#### 7.8.C Supervision

1. The contractor shall supervise contractor employees to ensure compliance with the terms and conditions of the contract.
2. The contractor shall be responsible for maintaining satisfactory standards of employee competency, conduct, appearance, and integrity. The contractor shall be responsible for taking any necessary disciplinary actions with respect to his/her employees.
3. The NRC PO may require removal from the job site any contractor's employees deemed to be unsuitable or otherwise objectionable or whose continued employment under the contract is deemed to be contrary to the public interest or inconsistent with the best interests of the government.
4. The NRC PO who inspects and accepts contractor work must complete a Form GSA-220 or other acceptable document for the file.

### 7.9 ENVIRONMENTAL HEALTH SERVICES PLAN

#### 7.9.A Definitions

1. The term "environmental health" shall refer to the protection of the environment either indoors or outdoors and provide for the protection of those individuals occupying the complex and its surroundings.
2. The term "indoor air quality" (IAQ) shall refer to the general healthfulness and quality of the air.

#### 7.9.B Authority/Guidelines

The term "American Society of Heating, Refrigeration, and Air-Conditioning Engineers, Inc." (ASHRAE) refers to the organization which establishes and provides guidelines for all aspects of environmental health including IAQ.

7.9.C Scope of Work

1. The NRC shall provide a term contract for obtaining Industrial Hygienist Services for testing of the environment and providing for the safety and health of all occupants.
2. The NRC will have specific delegated authority for requesting environmental testing in support of documentation of environmental, health or safety concerns. NRC budget will be utilized when placing orders against the contract.
3. The NRC will discuss, evaluate and determine a course of action by preparing an action plan, if required, to eliminate the environmental, health or safety issue.
4. All results of environmental testing shall be provided to NRC's Health and Safety Officer, Union or other designated and approved individual, committee or staff.

7.10 SAFETY INSPECTION SERVICES

7.10.A Definitions

1. The term "safety" shall refer to the protection of employees, contractors and visitors from conditions that exist or could exist, and may cause injury, damage or loss to that individual or property.
2. The term "inspection" shall refer to checking or testing of a condition or area to assure safety compliance with a set of established standards.
3. The term "code" shall refer to the Life Safety Code which has established minimum requirements that provide a reasonable degree of safety from fire in buildings or structures. The objective of the Code is to provide a reasonable level of safety by reducing the probability of injury and loss of life from the affects of fire and other emergencies having the potential for similar consequences with due consideration for functional requirements.
4. The term "accessibility means of egress" is a path to travel that is usable by a person with severe mobility impairment that leads to a public way or an area of refuge.
5. The term "area of refuge" is an accessible space protected from fire or smoke, separated from all other spaces in the same building or an adjacent building that permits a delay in egress travel from any level.

#### 7.10.B Authority/Guidelines

1. The term "National Fire Protection Association" (NFPA) provides for the technical guidance of the Code which is followed by fire departments nationwide and establishes minimum requirements that will provide a reasonable degree of safety from fire or smoke in buildings or structures.
2. The term "Agency" refers to the NRC which provides guidelines through their Safety Management Manual, on conducting safety and occupational health inspections.

#### 7.10.C Scope of Work

1. The GSA will conduct unannounced periodic inspections of occupied spaces by government employees and contractor staff in accordance with established guidelines from GSA and NRC and also by governing authorities, i.e., NIOSH, OSHA, Department of Health and Human Services or NFPA.
2. The GSA will have the authority to request and immediately correct any reported safety violation, if that violation is an immediate concern to the safety and health of all occupants of NRC space or property. NRC will correct any safety violation related to the structure since they have the overall building responsibility.
3. The NRC shall work to correct, eliminate or prevent safety violations that affect the daily operation of the facility.
4. The NRC will work to coordinate and develop a training program for staff involved with or performing building safety inspections.
5. All routine fire drills that are required shall be coordinated with the NRC Division of Facilities and Security and the GSA Building Manager and designated representative(s).

### 7.11 SPACE UTILIZATION OPERATING PLAN

#### 7.11.A General

The purpose of this section is to identify the relationship and responsibility between GSA/NRC regarding space utilization.

#### 7.11.B Definition

The term space utilization shall include all space assignments in areas occupied by NRC or its contractors (including but not limited to, office space, special space, and most parking). Space assignments are the responsibility of NRC.

#### 7.11.C Scope of Work

1. The NRC must notify GSA of any changes within any space in the building which affects rent billing. Included is conversion, reclassification of space as a result of alterations, and increases or decreases in space assignments to organizations that have rent billing codes.
2. The NRC is not authorized to enter into leases to sublet or out-lease any of their assigned space; however, GSA may award such an out-lease in space identified by NRC as vacant or otherwise surplus to its needs.
3. The NRC is responsible for effectively managing its assigned space. NRC agrees to comply with the appropriate Federal Property Management Regulations pertaining to space management and utilization.

### 7.12 REPAIR AND ALTERATIONS OPERATING PLAN

#### 7.12.A General

The purpose of this section is to identify the relationship and responsibility between NRC and GSA regarding repairs and alterations.

#### 7.12.B Repair and Alterations Operation Plan

1. Overview – The NRC internal process for order preparation:
  - A. the NRC will receive space requests from their various components;
  - B. the NRC will review, survey and determine the action necessary;
  - C. the NRC will perform a preconstruction on-site survey;
  - D. the NRC will prepare drawings/floor plans. In addition, the NRC will be responsible for the preparation of the construction package which will include: all floor plans, layouts, demolition, construction, telephones, electricity, paint, legends, etc., and;

- E. the NRC will ensure that internal management and funding approvals are obtained and that the required signatures on the floor plan(s) are acquired.
2. The GSA will notify NRC when job cost differs from the original estimate and provide the updated cost information.
3. The GSA will maintain overall control of building alterations in excess of \$100,000 via review and approval of building alteration packages. GSA and/or NRC will monitor and inspect all building alterations both while in progress and upon completion. Any NRC representative who inspects and accepts contractor work must complete a Form GSA-220 or other acceptable document for the file.
4. The NRC will utilize GSA to contract for all modifications (including design as needed) in excess of \$100,000.
5. The NRC will utilize its space management staff and CAD system to design space and building alterations in general office space. In addition, GSA will have access to drawing files and continually updated CAD floor plans.
6. Space alterations having an estimated value of \$100,000 or more, or which will result in a change in the classification of space, must have prior review and approval of GSA. In addition, existing safety systems such as fire alarm system(s), sprinkler system(s), exit system(s) components, and equipment shall not be changed through repairs, alterations, space modification or improvements regardless of cost without prior written approval by GSA.
7. The request for review and approval of projects valued over \$100,000 will be submitted to GSA as early in the planning process as possible, but in no event less than 60 calendar days prior to the planned issuance of a solicitation or request for proposal to accomplish the proposed work. This request must be made in writing, and shall be accompanied by narratives, plans, drawings, or schematics sufficiently detailed to allow GSA to evaluate the scope of the project and its impact on the building structure or systems.
8. The GSA will respond to the request within 60 working days after receipt. If a technical review is either required by GSA or requested by NRC, GSA will advise NRC of the estimated date the technical review will be completed. GSA will keep NRC informed of the progress of the technical review, and NRC may not proceed without written GSA approval.



9. The GSA will provide NRC shop and as-built drawings upon project completion.
10. Upon completion of any approved work, NRC shall update drawing files to show all changes made to the building as a result of the work.
11. The NRC will submit to GSA for approval all proposed contracts for building or site work alterations or any proposed contract which may have an impact on the building/building systems or site. NRC agrees to update CAD/Aperture files with shop and as built drawings information for these changes.

### 7.13 COMPUTER AIDED DESIGN SYSTEM PLAN

#### 7.13.A General

1. NRC administers the CAD system.
2. NRC provides hardware, software and training.
3. NRC is responsible for system maintenance and upgrades.
4. NRC establishes master drawing files based on original building construction documents and information for all building alterations performed since original construction was completed.
5. Drawing files and hard copies will be accessible to GSA/NRC.

### 7.14 CONCESSIONS/CAFETERIA OPERATING PLAN

#### 7.14.A General

The purpose of this section is to ensure that cafeteria and vending service will be provided at this site and comply with local, state, and Federal regulations and laws.

#### 7.14.B Cafeteria Services

The term "Cafeteria Services" shall refer to services provided by a service contract administered by NRC.

#### 7.14.C Vending/Concessions

Services provided under a permit with the Maryland Business Enterprise Program for the Blind. They, in turn, will contract for all vending services at this location.

7.14.D Scope of Work

1. Cafeteria services will be provided by a government contract and will provide the food and service required to meet the daily requirements of NRC. The cafeteria will operate from 6:30 a.m. through 2:00 p.m. daily except Saturday, Sunday, or Federal holidays.
2. There will be a four week cycle menu to include two entrees, vegetables, salads, drinks, and desserts. A salad bar, specialty bar, pizza area, deli and grill area will be provided.
3. The cafeteria contractor will be required to maintain the kitchen area and back of the service area in a sanitary condition at all times.
4. The NRC's custodial contractor will be responsible for cleaning the dining area.
5. Garbage will be removed by the cafeteria contractor to a location provided by the NRC. Trash from the eating area will be removed by the custodial contractor based on an agreed-upon schedule.
6. NRC will provide exterminating services for the entire cafeteria area on a weekly basis.
7. The NRC/GSA will perform joint inspections of the cafeteria and share the results with the contractor. NRC will work to correct any problems.
8. The NRC will provide daily support to the cafeteria contractor in regard to addressing and following up on utility maintenance calls, structural repairs, and daily concerns of NRC personnel.
9. The NRC will provide semi-annual health and sanitation inspections of the cafeteria facility and do the follow-up to the same. Copies of these inspections will be provided to GSA on request.
10. Special requirements of NRC will be directed to GSA for discussion and resolution.
11. Vending machines will be provided and placed strategically throughout the building. Signage on the machines will direct users to a phone number to call for service.

7.14.E Supervision

The cafeteria contractor and NRC will be responsible for the supervision of their respective facilities.

8. REFERENCES

1. The term "National Fire Protection Association" provides for the technical guidance of the Code which is followed by fire departments nationwide and establishes minimum requirements that will provide a reasonable degree of safety from fire or smoke in buildings or structures.
2. The term "Agency" refers to the NRC which provides guidelines through their Safety Management Manual, on conducting safety and occupational health inspections.
3. The term "American Society of Heating, Refrigeration, and Air-Conditioning Engineers, Inc." refers to the organization which establishes and provides guidelines for all aspects of environmental health including IAQ.
4. The term "Environmental Protection Agency" refers to the official Federal governmental authorities who provide guidelines, laws and regulations relating to environmental issues.
5. The term "Occupational Safety and Health Administration" refers to the official Federal governmental authority which provides guidelines, laws and regulations providing for the occupational safety and health of employees and enforces standards for workplace health and safety.
6. The term "American Industrial Hygiene Association" and "American Conference of Government Industrial Hygienists" are organizations which provide valuable information on all aspects of environmental and industrial health and worker safety.
7. The term "American National Standards Institute" and the "*Code of Federal Regulations*" will be used to provide standards, rules, regulations and interpretations of those laws for protecting employees which will be followed and adhered to by the government.

8. GSA 5850 Guidelines and manufacturer recommendations (industry standard practices) will be utilized for PM procedures.

Signatures

\_\_\_\_\_  
Realty Services Manager  
U.S. General Services Administration

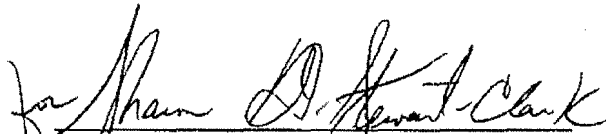
  
\_\_\_\_\_  
Director, Office of Administration  
U.S. Nuclear Regulatory Commission

\_\_\_\_\_  
Date

6/10/11  
Date

## EXHIBIT C

# Release and Non-Disclosure Agreement



*RELEASE AND NON-DISCLOSURE AGREEMENT*

As provided in that certain Delegation of Authority and Interagency Agreement (Delegation) from the Administrator of General Services (GSA) to the Chairman of the U.S. Nuclear Regulatory Commission (Agency) effective as of \_\_\_\_\_, the Agency, on behalf of itself and its contractors and subcontractors, acknowledges and understands that they will be given access to Sensitive But Unclassified (SBU) building information in connection with the operation, maintenance and alteration of the One White Flint North Building, located at 11555 Rockville Pike, Rockville, Maryland, if, and only if, they have first executed this Release and Non-Disclosure Agreement (Agreement). Each employee of the Agency and its contractors and subcontractors that executes this Agreement will be considered an "Authorized Party." Each Authorized Party acknowledges, understands and agrees that any SBU building information is for use by the Authorized Party only for the purposes described in the Delegation. In support of this requirement, GSA requires that each Authorized Party exercise best efforts when handling documents containing SBU building information in accordance with the following procedures. SBU building information may be in an electronic or hard copy format.

**1. Prohibition on Disclosure of SBU Building Information.** Each Authorized Party hereby agrees not to disclose the contents of SBU building information to anyone (including co-workers), unless that person has a need-to-know and previously has provided the Agency's Contracting Officer (CO) with an executed Agreement.

**2. Destruction of SBU Building Information.** The requirements of this Agreement will continue throughout the entire term of the Delegation and for whatever period of time that SBU building information continues to exist. All SBU building information must be destroyed at the expiration or earlier termination of the Delegation.

**3. Written Confirmation of Disposal or Return of SBU Building Information to the Agency.** When the project for which the SBU building information was provided is complete, each Authorized Party must provide the Agency's CO, at the time the Release of Claims form is submitted by the contractor or subcontractor, with a written statement that all SBU building information in their possession or control has been destroyed properly. In lieu of destroying the SBU building information, the Authorized Party may return the SBU building information to the Agency's CO for destruction.

**4. Best Efforts.** Each Authorized Party further agrees to use best efforts to safeguard the SBU building information to prevent unauthorized access by unauthorized individuals. In the event that an Authorized Party becomes aware of an unauthorized disclosure of SBU building information, then the Authorized Party must report the disclosure immediately to the Agency's CO.

The undersigned hereby commits to the United States of America to comply with the terms of this Agreement.

By: \_\_\_\_\_

Print Name: \_\_\_\_\_

Title: \_\_\_\_\_

Name of Organization: \_\_\_\_\_

Date: \_\_\_\_\_