

**Proprietary Information Withhold from Public Disclosure
Under 10 CFR 2.390**

This letter is decontrolled when separated from Enclosures 1 and 3



Tennessee Valley Authority, 1101 Market Street, Chattanooga, Tennessee 37402

CNL-19-007

January 16, 2019

10 CFR 50.90
10CFR 2.390

ATTN: Document Control Desk
U.S. Nuclear Regulatory Commission
Washington, D.C. 20555-0001

Browns Ferry Nuclear Plant, Units 1, 2, and 3
Renewed Facility Operating License Nos. DPR-33, DPR-52, and DPR-68
NRC Docket Nos. 50-259, 50-260, and 50-296

Subject: Proposed Technical Specifications (TS) Change TS-510 - Request for License Amendments - Maximum Extended Load Line Limit Analysis Plus - Supplement 5, Response to Requests for Additional Information

- References:
1. Letter from TVA to NRC, CNL-18-002, "Proposed Technical Specifications (TS) Change TS-510 - Request for License Amendments - Maximum Extended Load Line Limit Analysis Plus," dated February 23, 2018 (ML18057B276)
 2. Letter from NRC to TVA, "Browns Ferry Nuclear Plant - Request for Additional Information Regarding Maximum Extended Load Line Limit Analysis Limit Plus License Amendment Request (EPID L-2018-LLA-0048)," dated December 6, 2018 (ML18331A546)

By the Reference 1 letter, Tennessee Valley Authority (TVA) submitted a request for a Technical Specification (TS) amendment (TS-510) to Renewed Facility Operating License Nos. DPR-33, DPR-52, and DPR-68 for Browns Ferry Nuclear Plant (BFN) Units 1, 2, and 3, respectively. The proposed amendment allows operation in the expanded Maximum Extended Load Line Limit Analysis Plus (MELLLA+) operating domain and use of the Detect and Suppress Solution - Confirmation Density (DSS-CD) stability solution. During their technical review of the LAR, the Nuclear Regulatory Commission (NRC) identified the need for additional information. The Reference 2 letter provided NRC Requests for Additional Information (RAIs) from the Reactor Systems Branch (SRXB) and the Nuclear Performance and Code Review Branch (SNPB). The due date for the responses to the NRC RAIs provided by the Reference 2 letter is January 18, 2019. Subsequently, it was determined that additional time was needed to complete the responses to SRXB RAI-6 and SRXB RAI-7 and the due date for submittal of the responses to these RAIs was extended to January 25, 2019, per communication with the NRC Project Manager. Enclosures 1 through 5 to this letter provide the responses to the remainder of the RAIs included in the Reference 2 letter.

General Electric - Hitachi Nuclear Energy Americas LLC (GEH) considers portions of the information provided in Enclosure 1 to this letter to be proprietary and, therefore, exempt from public disclosure pursuant to 10 CFR 2.390. An affidavit for withholding information, executed by GEH, are provided in Attachment 6. Enclosure 2 to this letter provides a non-proprietary version of the responses to the RAIs provided in Enclosure 1. Therefore, on behalf of GEH, TVA requests that Enclosure 1 be withheld from public disclosure in accordance with the GEH affidavit and the provisions of 10 CFR 2.390.

Framatome Inc. (Framatome) considers portions of the information provided in Enclosure 3 to this letter to be proprietary and, therefore, exempt from public disclosure pursuant to 10 CFR 2.390. An affidavit for withholding information, executed by Framatome, is provided in Enclosure 7. Enclosure 4 to this letter provides a non-proprietary version of the responses to the RAIs provided in Enclosure 3. Therefore, on behalf of Framatome, TVA requests that Enclosure 3 be withheld from public disclosure in accordance with the Framatome affidavit and the provisions of 10 CFR 2.390.

TVA has reviewed the information supporting a finding of no significant hazards consideration and the environmental consideration provided to the NRC in the Reference 1 letter. The supplemental information provided in this submittal does not affect the bases for concluding that the proposed license amendment does not involve a significant hazards consideration. In addition, the supplemental information in this submittal does not affect the bases for concluding that neither an environmental impact statement nor an environmental assessment needs to be prepared in connection with the proposed license amendment. Additionally, in accordance with 10 CFR 50.91(b)(1), TVA is sending a copy of this letter and the non-proprietary enclosures to the Alabama State Department of Public Health.

There are no new regulatory commitments associated with this submittal. If there are any questions or if additional information is needed, please contact Mr. Michael A. Brown at (423) 751-3275.

I declare under penalty of perjury that the foregoing is true and correct. Executed on the 16th day of January 2019.

Respectfully,



E. K. Henderson
Director, Nuclear Regulatory Affairs

Enclosures

cc: See page 3

**Proprietary Information Withhold from Public Disclosure
Under 10 CFR 2.390**

This letter is decontrolled when separated from Enclosures 1 and 3

Enclosures:

1. Responses to SRXB RAI-1, SRXB RAI-2, SRXB RAI-3, SRXB RAI-4, SNPB RAI-1a, and SRXB-C RAI-6 (Proprietary)
2. Responses to SRXB RAI-1, SRXB RAI-2, SRXB RAI-3, SRXB RAI-4, SNPB RAI-1a, and SRXB-C RAI-6 (Non-proprietary)
3. Responses to SRXB RAI-8, SRXB RAI-9, SRXB RAI-10, SNPB RAI-1b, SNPB RAI-1c, SNPB RAI-1d, SNPB RAI-2, and SNPB RAI-3 (Proprietary)
4. Responses to SRXB RAI-8, SRXB RAI-9, SRXB RAI-10, SNPB RAI-1b, SNPB RAI-1c, SNPB RAI-1d, SNPB RAI-2, and SNPB RAI-3 (Non-proprietary)
5. Responses to SRXB RAI-5, SNPB RAI-4, SRXB-C RAI-1, SRXB-C RAI-2, SRXB-C RAI-3, SRXB-C RAI-4, and SRXB-C RAI-5 (Non-proprietary)
6. Affidavit – GE-Hitachi Nuclear Energy Americas LLC
7. Affidavit – Framatome Inc.

cc:

NRC Regional Administrator - Region II
NRC Senior Resident Inspector - Browns Ferry Nuclear Plant
State Health Officer, Alabama Department of Public Health
(w/o Enclosures 1 and 3)

ENCLOSURE 1

**Responses to SRXB RAI-1, SRXB RAI-2, SRXB RAI-3, SRXB RAI-4,
SNPB RAI-1a, and SRXB-C RAI-6
(Proprietary)**

ENCLOSURE 2

**Responses to SRXB RAI-1, SRXB RAI-2, SRXB RAI-3, SRXB RAI-4,
SNPB RAI-1a, and SRXB-C RAI-6
(Non-proprietary)**

ENCLOSURE 2

DOC-0007-4283-138

Responses to SRXB-RAI 1, 2, 3, and 4, SNPB-RAI-1a, and SRXB-C-RAI-6 in Support of BFN MELLLA+ LAR

Non-Proprietary Information

NON-PROPRIETARY NOTICE

This is a non-proprietary version of Enclosure 1 of DOC-0007-4283-138 which has the proprietary information removed. Portions of the document that have been removed are indicated by an open and closed bracket as shown here [[]].

SRXB RAI-1

Section 9.3.3 of the M+SAR, NEDC-33877P, Revision 0 contains an ATWS with core instability (ATWS-I) sensitivity study that contains six fuel related parameters which are varied to determine their impact on the analysis results. However, the licensing basis ATWS analysis in Section 9.3.1.1 of the M+SAR contains three of the same parameters for sensitivity studies but does not include [[]]. Explain why these sensitivity studies are not necessary to be completed for the ATWS analysis to ensure that they are not necessary to demonstrate compliance with the ATWS acceptance criteria.

GEH Response

The following fuel parameters were included in the ATWS-I analysis but not in the anticipated transient without scram (ATWS) analysis:

- [[

]]

SRXB RAI-2

The ATWS-I fuel parameter sensitivity studies in Section 9.3.3 of the M+SAR were completed for the 2-recirculation pump trip (2RPT) event. Provide the results of the ATWS-I fuel parameter sensitivity studies for the [[]] case (equivalent to Table 9-11 in the M+SAR) to ensure that the 2RPT event will continue to be limiting and to demonstrate that the ATWS acceptance criteria are met for potentially limiting ATWS-I events.

GEH Response

The results of the ATWS-I fuel parameter sensitivity studies are provided in Table SRXB-2-1 below. [[

]] The results demonstrate that the 2RPT event remains bounding when the effects of the parameter sensitivities are included.

Table SRXB-2-1 ATWS-I Fuel Parameter Sensitivity Study Results

Sensitivity Parameter	Sensitivity Multiplier	[[.....]] PCT (K) / (°F)
Nominal	[[
Direct Moderator Heating		
Direct Moderator Heating		
Dynamic Gap Conductance		
Dynamic Gap Conductance		
Core Channel Inlet Losses		
Core Channel Inlet Losses		
Nominal – Internal Void Coefficient TRACG model deactivated ¹		
Void Coefficient ¹		
Void Coefficient ¹		
Leakage (Bypass) Losses		
Leakage (Bypass) Losses		
GEXL Critical Quality (CPR Units)		
GEXL Critical Quality (CPR Units)		
Bounding		
Bounding – Internal Void Coefficient TRACG model deactivated ¹]]

Note:

1. The internal TRACG void coefficient model is deactivated. These cases have a different base than the other sensitivities, and the void coefficient bias and uncertainty is perturbed

separately. It is noted that the difference between the bounding and nominal for these cases is less than the difference between the bounding and nominal for the other sensitivities.

SRXB RAI-3

The ATWS-I sensitivity study using homogeneous nucleation for minimum stable film boiling temperature (T_{min}) was provided for the 2RPT event in Section 9.3.3 of the M+SAR. Please provide the result using homogeneous nucleation T_{min} model for the turbine trip with bypass (TTWBP) case to ensure that the 2RPT event will continue to be limiting and to demonstrate that the ATWS acceptance criteria are met for potentially limiting ATWS-I events.

GEH Response

The results of the ATWS-I T_{min} parameter and quench model sensitivity studies are provided in Table SRXB-3-1 below. The results demonstrate that the 2RPT event remains bounding when the conservative homogeneous nucleation T_{min} is assumed.

Table SRXB-3-1 ATWS-I T_{min} and Quench Model Sensitivity Study Results

Event	[[PCT (K) / (°F)
TTWBP – Middle of Cycle (MOC) – Regional			
TTWBP – MOC – Regional - Bounding Fuel Parameter Sensitivity]]

SRXB RAI-4

Table 9-10, "PCT Results for ATWSI Sensitivity Analysis," of the M+SAR (Reference 4) shows that the bounding fuel parameter sensitivity case for [[]] gives an [[]] in PCT compared to using nominal fuel parameter values; however, for the Homogeneous Nucleation case, the bounding fuel parameter sensitivities account for [[]] increase in PCT over the nominal fuel parameter case. To ensure the model adequately models the transient to meet the ATWS acceptance criteria, explain why this larger PCT increase occurred for the Homogeneous Nucleation case, using detailed TRACG results from relevant ATWS-I cases to support the explanation.

REFERENCE

- 4 NEDO-33877, Revision 0 (Attachment 6 of LAR), "Safety Analysis Report for Browns Ferry Nuclear Plant Units 1, 2, and 3 Maximum Extended Load Line Limit Plus," dated February 2018 (ADAMS Accession No. ML18079B140).

GEH Response

As stated in Section 5.1 of Reference SRXB-4-1 (Enclosure 1 of the Browns Ferry Nuclear Plant (BFN) Maximum Extended Load Line Limit Analysis Plus (MELLLA+) License Amendment Request (LAR), Supplement 1), the higher temperatures in the bounding fuel parameter sensitivities (FPS) are because the cases with the bounding FPS [[]] the nominal cases. The figures and explanation below provide more details on this effect.

The bounding FPS results in [[

]]

[[

]]

Figure SRXB-4-1 Reactor Power - Nominal Versus Bounding FPS, HNT

Due to this, the limiting fuel rods enter transition boiling earlier and the maximum PCT during each oscillation is slightly larger. With the T_{\min} being set to a conservatively low value (using the Homogeneous Nucleation T_{\min} (HNT)), this small difference in PCT changes the time of failure to rewet significantly (See Figure SRXB-4-2). [[

]]

[[

]]

Figure SRXB-4-2 Core PCT - Nominal Versus Bounding FPS, HNT

Figure SRXB-4-3 includes results for a case in which the water level reduction (WLR) timing is delayed by 60 seconds further than the nominal case (WLR at 240 versus 180 seconds into the event). In the delayed WLR case, the PCT is very similar to the bounding FPS cases, just delayed in time.

[[

]]

Figure SRXB-4-3 Core PCT – Nominal, Delayed WLR Versus Bounding FPS, HNT

In both the delayed WLR case and the bounding FPS case, there is a [[

]] During ATWS-I scenarios, the core axial power shape becomes more bottom peaked. This happens for two reasons: 1) the recirculation pumps are tripped, and the core flow decreases; and 2) the feedwater temperature decreases, resulting in an increase in the core inlet subcooling. These factors both result in a more bottom peaked core power shape; additionally, these cases are at peak hot excess core exposure, which is already bottom peaked. During the event the boiling transitions that occur each oscillation [[

]] Figure SRXB-4-4 shows the behavior of the fuel rod temperature at these elevations for the hot rod in Channel 116. Note that Channel 116 is one of the limiting channels but is not always the limiting PCT channel. As can be seen in Figure SRXB-4-4, the [[

]] This is a clear indication that the effect of the bounding

FPS is primarily through the indirect effect on the timing of the failure to rewet and not on the PCT calculation directly.

[[

]]

**Figure SRXB-4-4 Rod Surface Temperature - Nominal, Delayed WLR Versus Bounding
FPS, HNT**

Reference:

- SRXB-4-1. GE Hitachi Nuclear Energy, "Browns Ferry Nuclear Plant Units 1, 2, and 3 MELLLA+ ATWS Supplemental Information," 004N6892-P Revision 1, February 2018. (Enclosure 1 to Letter, J. W. Shea (TVA) to NRC Document Control Desk, "Proposed Technical Specifications (TS) Change TS-510 – Request for License Amendments – Maximum Extended Load Line Limit Analysis Plus, Supplement 1," CNL-18-042, March 7, 2018).

SRXB RAI-5 through SRXB RAI-10

The responses to these RAIs are provided in a separate enclosure.

SNPB RAI-1

Section 9.3.1.1 of the M+SAR (Reference 4) states that [[

]]. To ensure the model adequately models the transient to meet the ATWS acceptance criteria, provide the following:

- a. Explain how the GEXL97 correlation is used in the ATWS-I analysis; especially during the dryout and rewet stages during an ATWS-I event (during oscillatory behavior).
- b. Explain how the GEXL97 coefficients are determined for ATRIUM 10XM (used in ATWS-I and DSS-CD calculations).
- c. Provide a summary of how the R-factors associated with GEXL97 correlation are determined for ATRIUM 10XM (used in the ATWS-I and DSS-CD calculations).
- d. Provide a summary of how the fuel rod location and geometry dependent additive constants are determined for the R-factors.

REFERENCE

- 4 NEDO-33877, Revision 0 (Attachment 6 of LAR), "Safety Analysis Report for Browns Ferry Nuclear Plant Units 1, 2, and 3 Maximum Extended Load Line Limit Plus," dated February 2018 (ADAMS Accession No. ML18079B140).

GEH Response

- a. GEXL97 is not used in the BFN MELLLA+ ATWS-I analysis. The GEXL97 coefficients are modified by Framatome to be applicable to ATRIUM-10XM. The resulting GEXL coefficients are used in the ATWS-I analysis as described in Section 2.6 of Reference SNPB-1-1 (Enclosure 1 of the BFN MELLLA+ LAR, Supplement 1).
- b. The response to this RAI is provided in a separate enclosure.
- c. The response to this RAI is provided in a separate enclosure.
- d. The response to this RAI is provided in a separate enclosure.

Reference:

- SNPB-1-1. GE Hitachi Nuclear Energy, "Browns Ferry Nuclear Plant Units 1, 2, and 3 MELLLA+ ATWS Supplemental Information," 004N6892-P Revision 1, February 2018. (Enclosure 1 to Letter, J. W. Shea (TVA) to NRC Document Control Desk, "Proposed Technical Specifications (TS) Change TS-510 – Request for License Amendments – Maximum Extended Load Line Limit Analysis Plus, Supplement 1," CNL-18-042, March 7, 2018).

SNPB RAI-2 through SNPB RAI-4

The responses to these RAIs are provided in a separate enclosure.

SRXB-C RAI-1 through SRXB-C RAI -5

The responses to these RAIs are provided in a separate enclosure.

SRXB-C-RAI 6

Regulatory basis in SRXB-C-RAI 5 is applicable to this RAI.

Table 4-6 of M+SAR (Reference 4), Note 2 is not clear. It states that the MELLLA+ "ATWS non-LOOP [loss of offsite power] PRFO EOC [End of Cycle]" results for peak suppression pool temperature are lower than the extended power uprate (EPU) results due to the use of more current ATWS analysis. The NRC staff requests details on the more current ATWS modeling and its differences/comparison with the EPU modeling, including the methodologies used. For reference, following are the licensing basis parameters for the EPU ATWS containment and NPSH analysis in Table 2.6.5-3 in the NRC Safety Evaluation dated August 14, 2017 (Reference 7).

Special Event	RHR Flow per HX* (gpm) (Note 1)	Initial SP** Temp (°F)	Peak SP Temp (°F)	RHRSW		Number of HXs used	K-value for 1 RHR HX (BTU/second-°F)
				Flow per RHR HX (gpm)	Temp (°F)		
ATWS-LOOP	6500	95	173.3	4500	95	2	277
ATWS-non LOOP	6500	95	171.8	3800	95	4	259

Note 1: Safety analysis flows assumed used for determining suppression pool temperature
 * HX – Heat Exchanger
 ** SP – Suppression Pool

REFERENCES

- NEDO-33877, Revision 0 (Attachment 6 of LAR), "Safety Analysis Report for Browns Ferry Nuclear Plant Units 1, 2, and 3 Maximum Extended Load Line Limit Plus," dated February 2018. (ADAMS Accession No. ML18057B276).
- U.S. NRC letter to TVA, Browns Ferry Nuclear Plant, Units 1, 2, and 3 - Issuance of Amendments Regarding Extended Power Uprate, dated August 14, 2017 (ADAMS Accession No. ML17032A120).

GEH Response

Table SRXB-C-6-1 below shows the BFN ATWS peak suppression pool temperature (SPT) results for EPU (Reference SRXB-C-6-1) and MELLLA+ (Reference SRXB-C-6-2) for the loss of offsite power (LOOP), the pressure regulator failure open (PRFO) and the main steam isolation valve closure (MSIVC) events (the MELLLA+ MSIVC result was not provided in the MELLLA+ safety analysis report (SAR)). As can be seen in Table SRXB-C-6-1, the LOOP results are slightly higher for MELLLA+; however, the PRFO and MSIVC results are significantly lower for MELLLA+ than EPU. The change in the PRFO and MSIVC results is an unexpected trend and is the result of an update to the reactor level control modeling procedure in ODYN, which was implemented for the BFN MELLLA+ PRFO and MSIVC event ATWS

analysis. This update to the reactor level control modeling procedure had previously been implemented for the BFN EPU LOOP event ATWS analysis.

Table SRXB-C-6-1 BFN ATWS Peak SPT Results for EPU and MELLLA+ for LOOP, PRFO and MSIVC Events

Event	EPU Peak SPT (°F)	MELLLA+ Peak SPT (°F)
LOOP	173.3	174.5
PRFO	171.8	164.4
MSIVC	171.8	164.0

In the BFN ATWS scenarios, feedwater is lost because the closure of the main steam isolation valves (MSIVs) shuts off steam flow to the turbine driven feedwater pumps. Emergency procedures result in operators lowering and controlling water level manually with high pressure coolant injection (HPCI) and reactor core isolation cooling (RCIC). To model this manual action in ODYN, the built-in feedwater level controller (FWLC) is used. In the EPU calculations for PRFO and MSIVC, the FWLC is used; however, the modeled capacity of feedwater is not adjusted. Because the recirculation pumps have been tripped (automatic ATWS function) and the water level is reduced, the reactor power level is much less than rated. In the ODYN model employed for the BFN EPU PRFO and MSIVC event ATWS analysis, GE Hitachi Nuclear Energy (GEH) used FWLC for convenience to model the manual use of HPCI and RCIC. However, the feedwater flow capacity is much higher than the combined flow capacity of HPCI and RCIC. Because the FWLC has significant excess capacity, the FWLC has difficulty controlling the level. This is because when the controller demands flow to maintain level, the flow quickly increases well above the amount of flow needed, the level increases and the flow is demanded to reduce. This results in a feedwater flow instability. This effect can be seen in Figure SRXB-C-6-1 below from about 100 to 900 seconds into the event. Figure SRXB-C-6-1 below is Figure 2.8-7 from the BFN EPU power uprate safety analysis report (PUSAR) (Reference SRXB-C-6-1).

GEH procedures for ATWS analysis were updated to improve the level control performance. The improvement was to restrict the feedwater capacity during the time when the FWLC is being used to model the manual use of HPCI and RCIC. The flow capacity is reduced to be consistent with HPCI plus RCIC capacity; the result is much more stable control of the water level, which is more consistent with the expected manual operation. The result can be seen in Figure SRXB-C-6-2 below. This is an ATWS PRFO end-of-cycle (EOC) case from the BFN MELLLA+ SAR (Reference SRXB-C-6-2).

The effect of the flow instability can be seen in the power response. The EPU cases with the excess flow capacity have higher average power during the low water period (from about 100 to 900 seconds). During this time, the higher average power results in more steam flow to the suppression pool and a higher suppression pool temperature.

The EPU ATWS LOOP case for BFN was performed with the improved level control modeling procedure. In Figure SRXB-C-6-3 below (Figure 2.8-13 from the BFN EPU PUSAR,

Reference SRXB-C-6-1), it can be seen that the feedwater response of the EPU ATWS LOOP case is significantly more stable, similar to Figure SRXB-C-6-2 below.

[[

]]

Figure SRXB-C-6-1 EPU PRFO EOC

[[

]]

Figure SRXB-C-6-2 MELLLA+ PRFO EOC

[[

]]

Figure SRXB-C-6-3 EPU LOOP EOC

References:

- SRXB-C-6-1. GE Hitachi Nuclear Energy, "Safety Analysis Report for Browns Ferry Nuclear Plant Units 1, 2, and 3 Extended Power Uprate," NEDC-33860P, Revision 1, October 2016.
- SRXB-C-6-2. GE Hitachi Nuclear Energy, "Safety Analysis Report for Browns Ferry Nuclear Plant Units 1, 2, and 3 Maximum Extended Load Line Limit Analysis Plus," NEDC-33877P, Revision 0, February 2018.

ENCLOSURE 3

**Responses to SRXB RAI-8, SRXB RAI-9, SRXB RAI-10,
SNPB RAI-1b, SNPB RAI-1c, SNPB RAI-1d, SNPB RAI-2, and SNPB RAI-3
(Proprietary)**

ENCLOSURE 4

**Responses to SRXB RAI-8, SRXB RAI-9, SRXB RAI-10,
SNPB RAI-1b, SNPB RAI-1c, SNPB RAI-1d, SNPB RAI-2, and SNPB RAI-3
(Non-proprietary)**

**Framatome RAI Responses for
Browns Ferry MELLA+**

ANP-3747NP
Revision 0

December 2018

© 2018 Framatome Inc.

Copyright © 2018

**Framatome Inc.
All Rights Reserved**

**ATRIUM is a trademark or registered trademarks of Framatome or its
affiliates, in the USA or other countries.**

Nature of Changes

Item	Section(s) or Page(s)	Description and Justification
1	All	Initial Issue

Contents

	<u>Page</u>
1.0 INTRODUCTION	1-1
2.0 NRC QUESTIONS AND FRAMATOME RESPONSE	2-1
3.0 REFERENCES	3-1

List of Tables

Table 1: Browns Ferry EPU MELLLA+ PCT Results for the Limiting Break Size	2-6
---	-----

List of Figures

Figure 1 EOCLB LRNB at 100P/85F – TSSS Key Parameters	2-3
Figure 2 EOCLB LRNB at 100P/85F – TSSS Sensed Water Level	2-3
Figure 3 EOCLB LRNB at 100P/85F – TSSS Vessel Pressures	2-4
Figure 4 EOCLB FWCF at 100P/85F – TSSS Key Parameters	2-4
Figure 5 EOCLB FWCF at 100P/85F – TSSS Sensed Water Level	2-5
Figure 6 EOCLB FWCF at 100P/85F – TSSS Vessel Pressures	2-5

Nomenclature

Acronym	Definition
AOO	Anticipated Operational Occurrences
ARO	All Rods Out
ATWS	Anticipated Transient Without Scram
ATWS-I	Anticipated Transient Without Scram Instability
BFN	Browns Ferry Nuclear Plant
BLEU	Blended Low Enriched Uranium
CFR	Code of Federal Regulations
CGU	Commercial Grade Uranium
CHF	Critical Heat Flux
CPR	Critical Power Ratio
CSDM	Cold Shutdown Margin
DSS-CD	Detect and Suppress Solution – Confirmation Density
ECCS	Emergency Core Cooling System
EM	Evaluation Model
EPU	Extended Power Uprate (defined as 120% OLTP, 3952 MWt)
FWCF	Feedwater Controller Failure
HEX	Hot Excess Reactivity
LAR	Licensing Amendment Request
LOCA	Loss of Coolant Accident
LRNB	Load Rejection Without Bypass
MELLA+	Maximum Extended Load Line Limit Analysis Plus
NRC	Nuclear Regulatory Commission
OLTP	Original Licensed Thermal Power (3293 MWt)

PCT	Peak Clad Temperature
PPD	Plant Parameters Document
RAI	Request for Additional Information
TSSS	Technical Specification Scram Speed
TVA	Tennessee Valley Authority

1.0 INTRODUCTION

Tennessee Valley Authority (TVA) submitted a License Amendment Request (LAR) to support an expansion of the core power flow operating range (i.e., maximum extended load line limit analysis plus (MELLLA+)) at the Browns Ferry Nuclear Plant (BFN), Units 1, 2, and 3. In response to the LAR, the US Nuclear Regulatory Commission (NRC) has issued an initial set of questions, in the form of Request for Additional Information (RAI), Reference 1.

2.0 NRC QUESTIONS AND FRAMATOME RESPONSE

The NRC questions (i.e., RAIs) listed below are according to Reference 1:

SRXB RAI-1 through SXR B RAI-7

The responses to these RAIs are provided in separate enclosures.

SRXB RAI-8

Provide the key parameter figures (like those in ANP-3552 Figures 5.1 through 5.6) for the 100 percent power and 85 percent core flow case for load reject no-bypass and the feedwater controller failure to understand the impact of MELLLA+ on these analyses to ensure they meet draft GDC 7. Discuss if the AOOs are reanalyzed each reload for all the MELLLA+ domain statepoints, and if not, describe why reanalysis is not necessary and what parameters are checked to ensure the original cases remain bounding (i.e., describe why the bounding analyses first analyzed for MELLLA+ will remain bounding in future cycles).*

Response to SRXB RAI-8:

Plots for the load reject no-bypass (LRNB) event and the feedwater controller failure (FWCF) at 100% rated core power, 85% rated core flow are shown in Figures 1 – 3 and Figures 4 – 6, respectively.

A disposition of events is created for a reactor to establish or re-establish the licensing basis in situations like vendor transitions, fuel transitions, and significant plant configuration modifications (i.e., extended power uprate (EPU) or MELLLA+). For each

* Attachment 18 of the LAR; ADAMS Accession No. ML18079B140

transient event in the final safety analysis report (FSAR) this disposition identifies which events 1) require cycle-specific analyses, 2) are analyzed for the initial reload, and 3) are non-limiting based on first principles.

The transient events identified for analysis are evaluated utilizing parameters provided by TVA in support of the initial licensing campaign. For follow-on cycle-specific licensing a plant parameters document (PPD) is provided by TVA. Prior to performing licensing calculations, the conclusions of the disposition of events are evaluated relative to plant parameter changes. Analyses which need to be re-evaluated are incorporated into a calculation plan and communicated to TVA to ensure the licensing basis is validated.

Additionally, the potentially limiting transient events analyzed on a cycle-specific basis (LRNB and FWCF events) must protect the entire power/flow map. Consistent with the Unit 1 transition, ATRIUM 10XM fuel transition, and the EPU LAR, the EPU/MELLLA+ LAR performed a full scope of transient analyses where the highest and lowest allowed core flow was evaluated for a given core power. In each of these instances, it was determined that high core flow provided the bounding result.

Impacts of cycle-specific plant parameter changes will continue to be evaluated relative to the disposition of events for future cycles of ATRIUM 10XM fuel and EPU/MELLLA+, as discussed previously. If a parameter change is identified that challenges conclusions of previous sensitivities, it will be addressed in the calculation plan and reported to TVA.

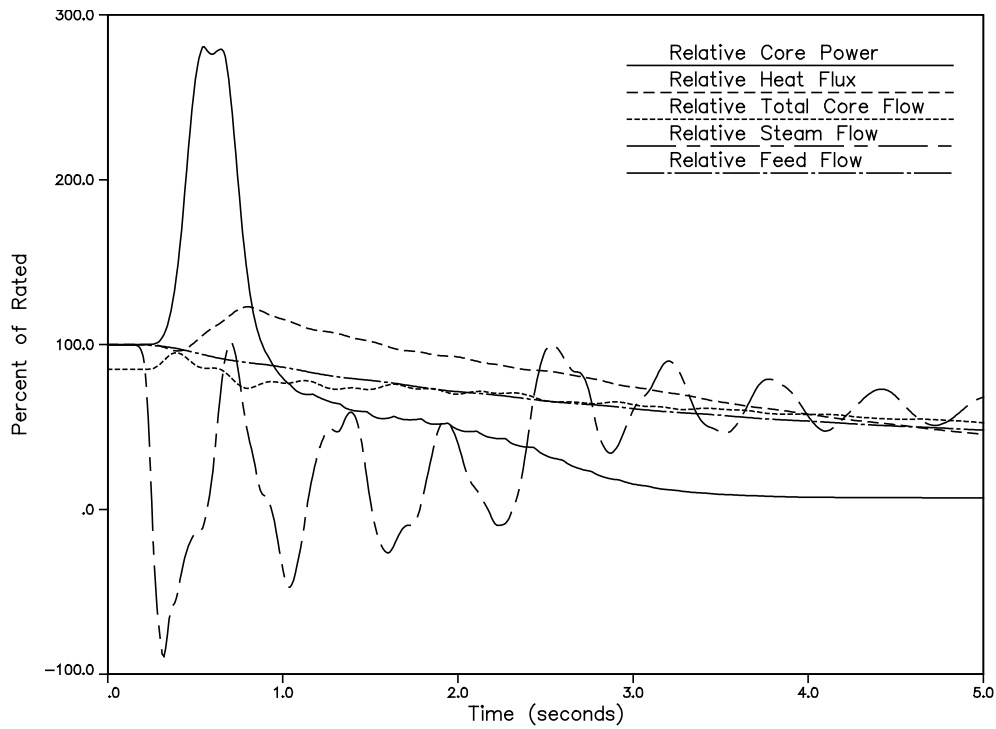

**Figure 1 EOCLB LRNB at 100P/85F – TSSS
Key Parameters**

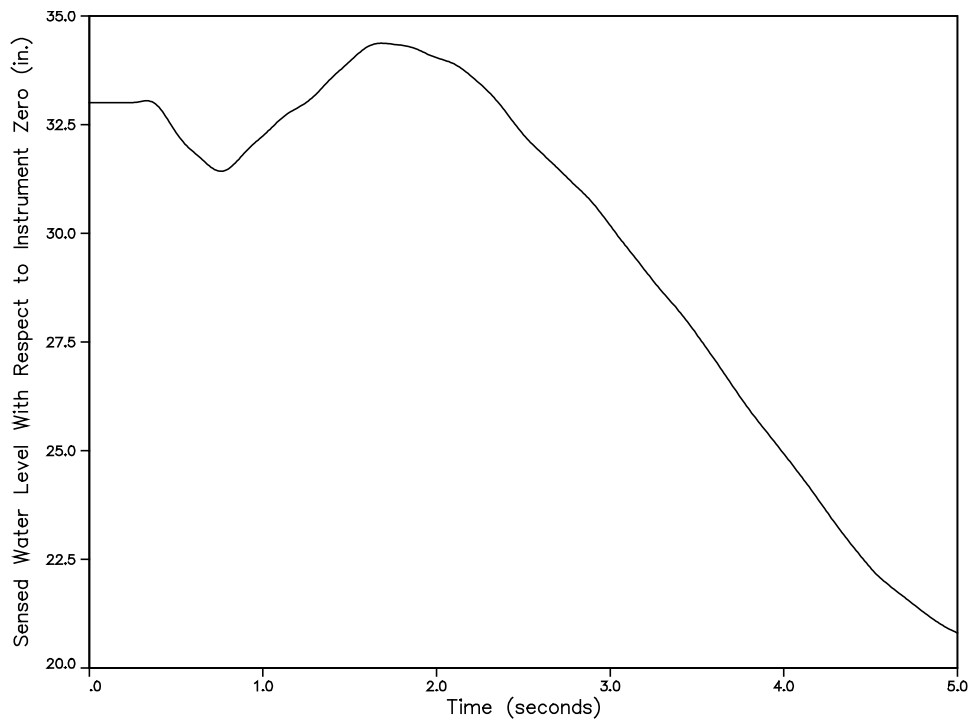

**Figure 2 EOCLB LRNB at 100P/85F – TSSS
Sensed Water Level**

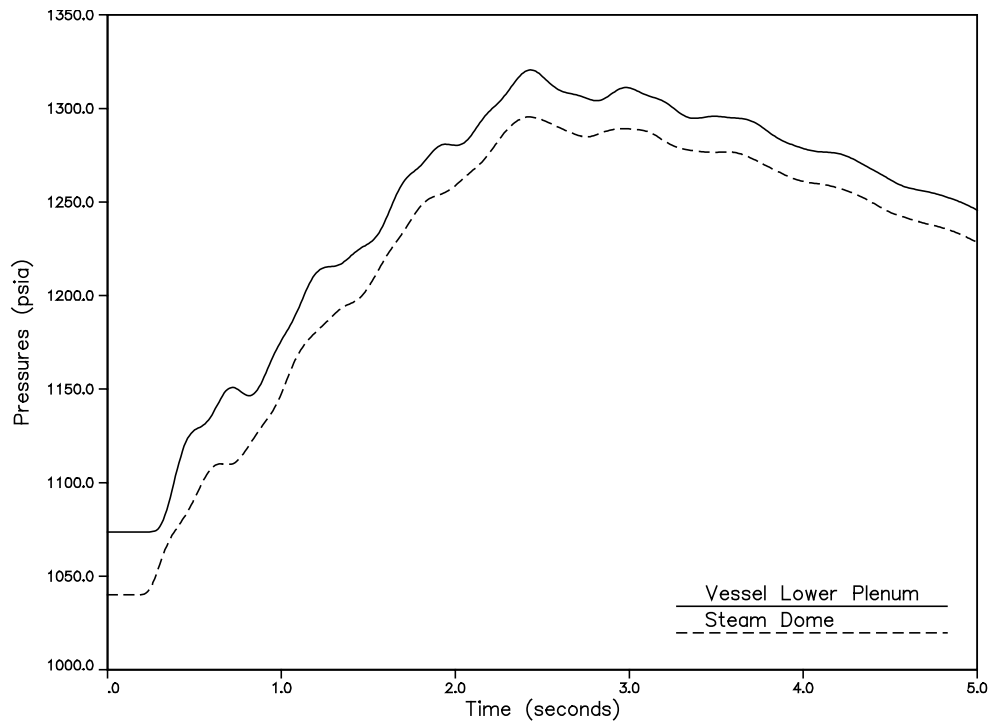

**Figure 3 EOCLB LRNB at 100P/85F – TSSS
Vessel Pressures**

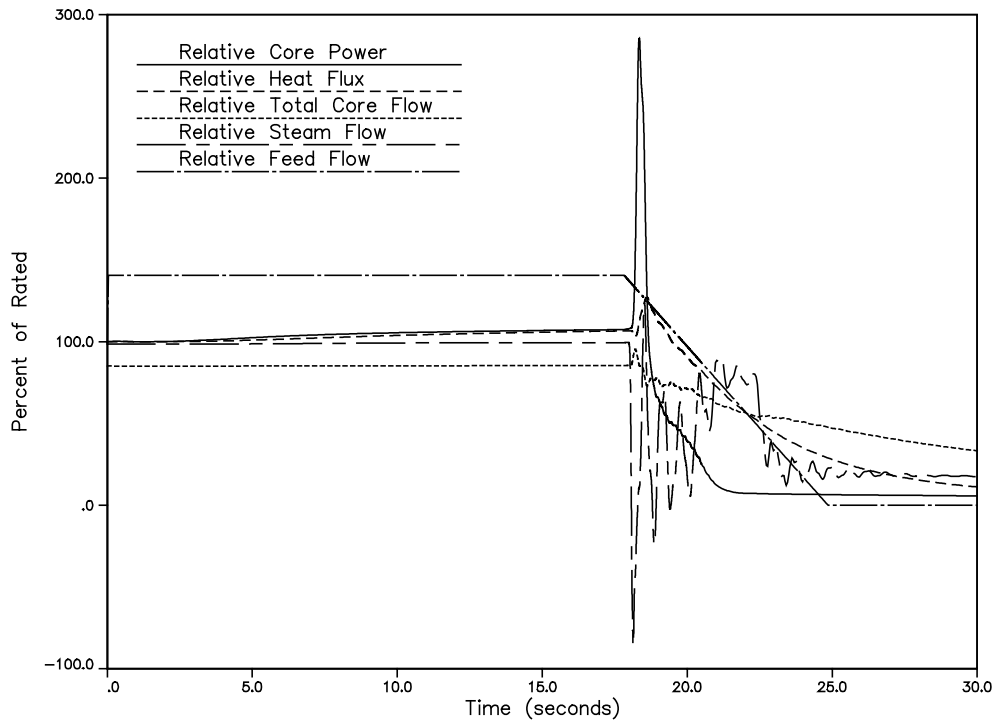

**Figure 4 EOCLB FWCF at 100P/85F – TSSS
Key Parameters**

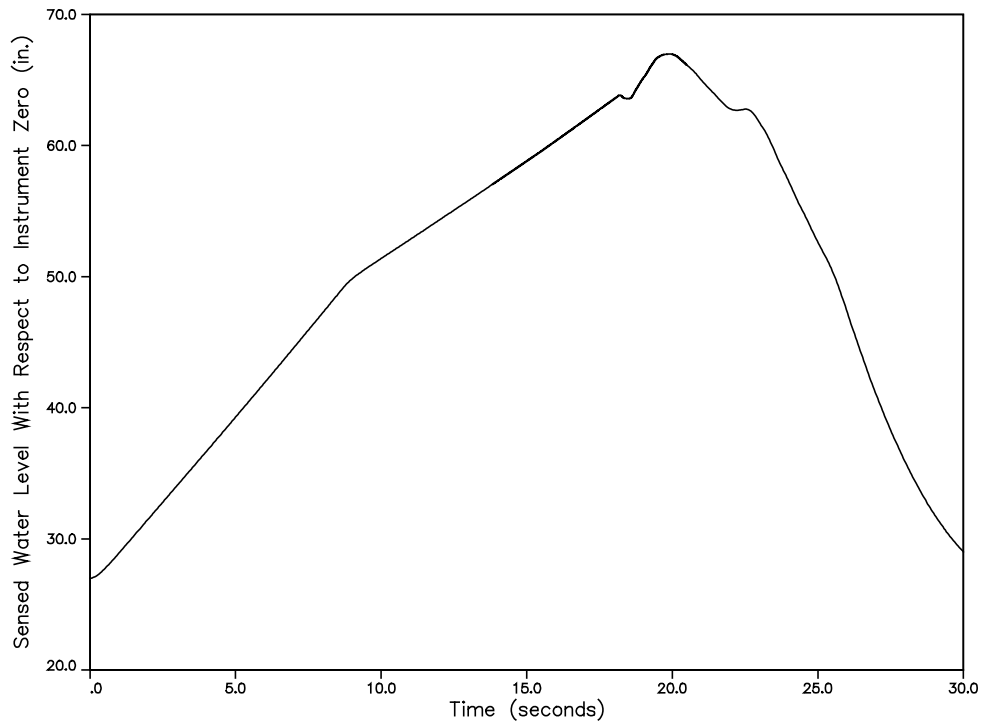

**Figure 5 EOCLB FWCF at 100P/85F – TSSS
Sensed Water Level**

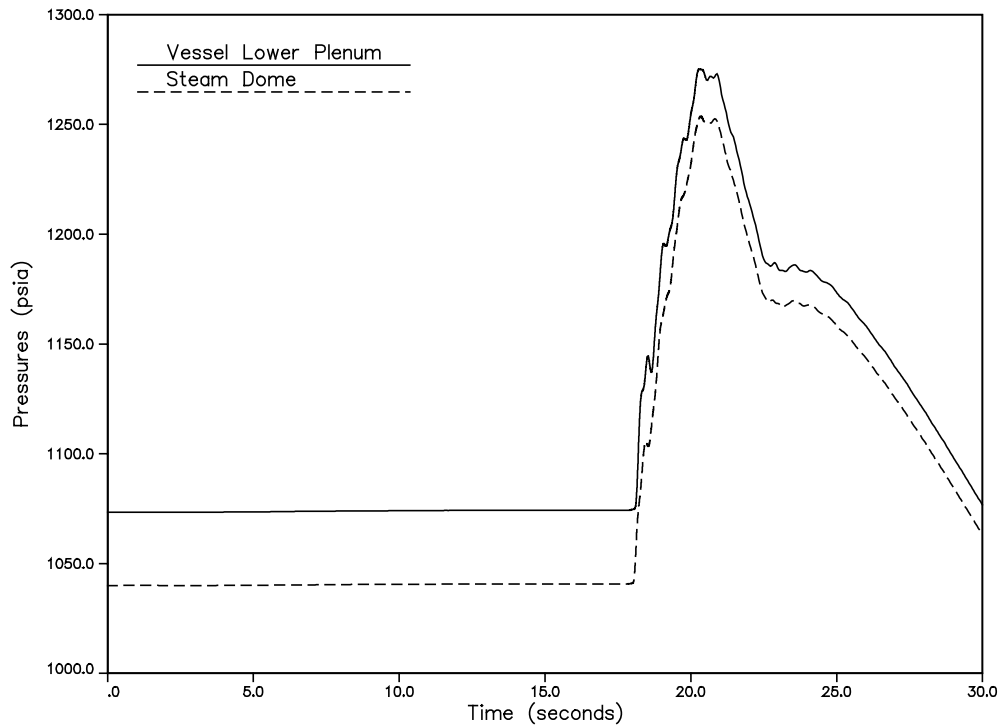

**Figure 6 EOCLB FWCF at 100P/85F – TSSS
Vessel Pressures**

SRXB RAI-9

10 CFR 50.46(a)(1)(i) requires, in part, that the ECCS cooling performance must be calculated in accordance with an acceptable EM and must be calculated for postulated LOCA with different sizes, locations, and other properties sufficient to provide assurance that the most severe postulated LOCAs are calculated. To ensure that the most severe postulated LOCAs are calculated, provide a sensitivity study for a point between 85 percent flow and 99 percent flow at full power for the limiting break size provided in the ANP-3546, "Browns Ferry Units 1, 2, and 3 LOCA Break Spectrum Analysis for ATRIUM 10XM Fuel (EPU MELLLA+)."*

Response to SRXB RAI-9:

Currently, the Browns Ferry peak cladding temperature (PCT) results are summarized as follows.

**Table 1: Browns Ferry EPU MELLLA+ PCT Results
for the Limiting Break Size**

Framatome had informed the NRC that an informal case at the 102% Power / [] Flow state point had been run for the limiting break size and that the result supported Framatome's position that the limiting PCT had been determined. Framatome has now

* Attachment 12 of the LAR; ADAMS Accession No. ML18079B140

performed a formal analysis for the 102% Power / [] Flow state point and found the PCT to be [] which provides Framatome confidence that the limiting power / flow state point has been determined.

SRXB RAI-10

Section 2.0 of ANP-3546 discusses that the break spectrum analysis was completed for ATRIUM 10XM fuel and justifies that it is applicable to other co-resident fuel, since their thermal-hydraulic characteristics are similar. Confirm that the only co-resident fuel during BFN MELLLA+ operation is ATRIUM 10. If not, provide additional justification for the other fuel types to ensure all fuel types are covered to meet the 10 CFR 50.46 acceptance criteria.

Response to SRXB RAI-10:

Implementation of MELLLA+ at Browns Ferry Units 1 and 3 will occur during cycles that include fresh and once burnt ATRIUM 10XM fuel and twice burnt ATRIUM-10 fuel. Browns Ferry Unit 2 will be a full core of ATRIUM 10XM fuel. Justification to use the system response of the limiting ATRIUM 10XM break to drive the heatup analysis for the co-resident ATRIUM-10 fuel was provided in Sections 1.0 and 2.0 of Attachment 15 of the LAR submittal (ADAMS accession ML18086A089). The only co-resident fuel for BFN MELLLA+ operation is ATRIUM-10. Reloads of any new fuel type at Browns Ferry would require a new, fuel type specific, break spectrum analysis.

SNPB RAI-1

Section 9.3.1.1 of the M+SAR* states that [

]

To ensure the model adequately models the transient to meet the ATWS acceptance criteria, provide the following:

- b. Explain how the GEXL97 coefficients are determined for ATRIUM 10XM (used in ATWS-I and DSS-CD calculations)
- c. Provide a summary of how the R-factors associated with GEXL97 correlation are determined for ATRIUM 10XM (used in the ATWS-I and DSS-CD calculations)
- d. Provide a summary of how the fuel rod location and geometry dependent additive constants are determined for the R-factors.

Response to SNPB RAI-1a:

The response to this RAI is provided in a separate enclosure.

Response to SNPB RAI-1b:

The GEXL correlation form and parameters were provided by GEH for the ATRIUM-10 fuel design. No changes to the correlation form were permitted for ATRIUM 10XM, and instead the coefficients were tuned to provide a conservative fit to the critical heat flux (CHF) data from Framatome's extensive ATRIUM 10XM critical power database (the same database that was used to develop the ACE/TRIUM 10XM correlation, References 2 and 3). It should be noted that the GEXL correlation for ATRIUM 10XM is not intended to be a general use correlation. Instead it was biased to provide a

* Attachment 6 of the LAR; ADAMS Accession No. ML18079B140.

conservative critical power ratio (CPR) prediction specifically for the ATWS-I event. As such, this correlation is not valid for all applications.

The GEXL correlation coefficients were tuned by hand until the predictions for the ATRIUM 10XM KATHY test data showed acceptable trends. The tuning of the correlation coefficients was done with several goals in mind. First, it was desirable for the correlation to be nearly best-estimate at the low flow conditions [

] For higher and lower mass flux ranges, the correlation could be more conservative. Second, it was desirable that the correlation be conservative for mid- and bottom-peaked axial power shapes. [

] Lastly, it was desirable for the range of applicability requirements for the ATRIUM-10 GEXL correlation to be maintained.

Once the correlation coefficients were developed, the benchmarking to the ATRIUM 10XM critical power data was reviewed and any trends and biases were evaluated. Additional details regarding these trends and biases are provided in Section 4.0 of Reference 4. It was found that the correlation met the stated goals, the trends were reasonable and expected, and there was appropriate conservatism in the results; the correlation coefficients were thus found to be acceptable.

Response to SNPB RAI-1c:

The GEXL correlation R-factors were determined on a bundle-by-bundle basis for the Browns Ferry MELLLA+ ATRIUM 10XM equilibrium core for the rod patterns, core flow, and heat balance basis requested by GEH at the exposures of interest.

The R-factors provided for the ATRIUM 10XM GEXL correlation were assumed to have the same analysis basis as K-factors in the ACE methodology. []

[

]

As the R-factor basis (bundle average K-factor) is not the same as the most recent, approved version of the ACE ATRIUM 10XM correlation (References 2 and 3), it was necessary to verify that the use of the R-factors in the GEXL correlation continues to provide conservative critical power results. Therefore, a comparison of the critical power prediction with the GEXL correlation using the calculated R-factors and the version of the ACE ATRIUM 10XM correlation using [] (References 2 and 3) was performed. The GEXL correlation was implemented within MICROBURN-B2 and steady state critical power calculations were performed for each exposure of interest. Additionally, both high and low flow statepoints were analyzed and the results confirm that the GEXL correlation bounds the version of the ACE ATRIUM 10XM correlation using [] (References 2 and 3).

Response to SNPB RAI-1d:

The K-factor methodology was used in place of the R-factor for the ATRIUM 10XM GEXL correlation. The K-factor contains the geometry/rod dependent term in the additive constant. The critical power database that was used to generate the GEXL correlation coefficients contains a variety of lattices with different peaking factors and addresses all of the necessary local effects. All lattice peakings used in the development of the ACE/ATRIUM 10XM correlation (References 2 and 3) were utilized for the development of the GEXL coefficients and they were all used to validate the rod dependent additive constants to be used with the GEXL correlation. The results of the benchmarking were reviewed to examine any trends in either rod location, rod peaking, or R-factor. As the ATRIUM 10XM GEXL correlation produced acceptable and

conservative results across the entire test suite, the GEXL correlation is shown to appropriately account for local effects, and the additive constants are shown to be appropriate.

SNPB RAI-2

ANP-3544 and ANP-3568† state that the equilibrium cycle assumes the use of blended low enriched uranium material for one fuel type to account for about 30 percent of the fresh reload assemblies. Discuss the impact of the use of blended low enriched uranium fuel during the MELLLA+ operation to ensure that it is appropriately accounted for in the steady state, transient, and accident analyses.*

Response to SNPB RAI-2:

The primary difference between blended low enriched uranium (BLEU) and commercial grade uranium (CGU) is the concentration of the uranium isotopes of U^{234} and U^{236} . BLEU material has a higher concentration of these isotopes when compared to the maximum allowed values for enriched CGU defined by ASTM C966-10. Chemically, there is no difference between BLEU and CGU. Within the fuel manufacturing process, the U^{234} and U^{236} isotopes are inseparable from its original BLEU feed stock.

The small changes in isotopic impurities of the BLEU fuel do not significantly affect the physical properties of the fuel.

Isotopes of uranium (e.g., U^{234} , U^{235} , U^{236} and U^{238}) have the same electronic structure. They also occupy the same space. Consequently, the substitution of a U^{234} or U^{236} for a U^{238} (or U^{235}) atom in the lattice does not constitute a point defect and does not change the local electronic configuration. The fuel thermal conductivity is therefore independent of the U^{234} and U^{236} content as it is also independent of the amount of U^{235} .

The primary difference in neutronic characteristics of BLEU relative to CGU fuel is decreased reactivity due to the higher concentration of U^{236} and U^{234} . The CASMO-

* Attachment 10 of the LAR; ADAMS Accession No. ML18079B140.

† Attachment 22 of the LAR; ADAMS Accession No. ML18079B140.

4/MICROBURN-B2 code system explicitly models the U^{234} and U^{236} with cross section data for a range of temperatures and voids. The behavior of these uranium isotopes under irradiation is well understood. The lattice depletion (CASMO-4) and 3D core simulator (MICROBURN-B2) codes track these isotopes to account for the off-spec concentrations. The impact on the usage of the BLEU material is accounted for by explicitly including the U^{234} and U^{236} isotopic concentrations in the fuel design and licensing process. Since the fissile isotopic inventory does not significantly deviate from normal expected variations the corresponding changes in fission products are insignificant. Because the changes are very small, these differences will result in a change in fuel thermal conductivity that can be neglected.

For the same reasons the thermal conductivity is not affected by the presence of U^{234} and U^{236} , other thermal mechanical properties are also not affected. This includes thermal expansion, heat capacity, enthalpy, Young's modulus, Poisson's ratio, creep, melting temperature and emissivity. The fuel density is slightly less by an insignificant amount. As a result, the physical properties used in the RODEX4 models are applied to BLEU fuel without change.

BLEU fuel has been utilized for 17 operating cycles at the Browns Ferry Units and has shown very good agreement between predicted and measured performance.

ANP-2860P Revision 2 Supplement 3P Revision 2 demonstrates the continued applicability of Framatome's approved licensing methods to the MELLLA+ operating domain at the Browns Ferry Units.

The design and licensing calculations supporting MELLLA+ operation at the Browns Ferry Units explicitly accounts for the impact of BLEU fuel.

SNPB RAI-3

ANP-3544 states that the core hot excess reactivity was calculated at full power with all rods out, 102.5 mega pounds per hour (Mlb/hr) core flow, with equilibrium xenon.

Discuss whether the hot excess reactivity calculated at this condition (full power, all rods out, 102 Mlb/hr) is suitable and valid for the BFN MELLLA+ operating domain to ensure the shutdown margin was appropriately determined for MELLLA+ conditions.

Response to SNPB RAI-3:

Hot Excess Reactivity (HEX) is a defined concept to determine how much reactivity must be overcome by use of the control rods during expected hot full power operation. For this reason, HEX calculations are performed at all-rods-out (ARO) conditions with the quantity of interest being the difference between the calculated k-effective and the hot target k-effective. Framatome's standard practice is to calculate HEX at rated conditions (i.e. both rated power and flow) in order to provide a common point of reference.

As described above, HEX is not a licensing related quantity but is a figure of merit utilized during the design process. HEX functions as a tool early in the design process that helps ensure that the rod patterns for a core design will retain the desired level of operational flexibility. For the final design, the more important characteristics are the resulting final control rod patterns.

Minimum Design Target: In general, a minimum HEX target is used to ensure that the expected operating rod patterns will have enough control density (i.e. inserted control rod notches) to ensure that full power operation can be maintained for the case when the hot k-effective may unexpectedly trend higher than the design target.

Maximum Design Target: A maximum HEX target is established to limit the control density to ensure reasonable margin to the thermal limits (i.e. higher control density may increase peaking thereby reducing thermal limit margin).

Hot Excess Swing: The difference between minimum and maximum targets also can be important since minimizing the change in HEX means fewer potentially required modifications to a rod pattern during a specified sequence (i.e. fewer required rod pattern adjustments).

From a historical perspective, the rated flow condition approached the lower boundary of the rated power flow window with EPU power flow maps. For pre-uprate plants, the rated power condition included a larger flow window. Consequently, the use of rated flow as a representative value within the expected flow window is historically supported. Furthermore, while it is recognized that use of a low flow condition would result in a lower calculated absolute value of HEX, the impact is small when compared to the typical design targets (e.g. 1% to 2.5% $\Delta k/k$).

As noted earlier, the more important parameter is the adequacy of the final rod patterns in the design. The resulting rod patterns provided in Appendix A of ANP-3544P, "Browns Ferry EPU (120% OLTP) MELLLA+ Equilibrium Fuel Cycle Design," (MELLLA+ LAR Attachment 9) demonstrate that this goal has been met. Based upon this demonstration and the above discussion, it is concluded that the standard use of the rated flow condition in the HEX calculation remains valid as a MELLLA+ design figure of merit.

Cold shutdown margin (CSDM) is calculated for cold (and higher temperatures) at critical conditions for exposure points throughout the cycle. MELLLA+ impact on the calculated CSDM is limited to changes in the underlying cycle depletion (i.e. exposure distribution and isotopic composition). As discussed above, HEX is strictly a design figure of merit. The depletion used in the CSDM calculations utilizes the design rod patterns which include expected operation in the MELLLA+ operating domain.

Consequently, the calculated CSDM is appropriately determined consistent with expected MELLLA+ operation.

SNPB RAI-4

The response to this RAI is provided in a separate enclosure.

3.0 REFERENCES

1. Letter FE Saba (USNRC) to JW Shea (TVA), "Brown Ferry Nuclear Plant, Units 1, 2, and 3 – Request for Additional Information Regarding Maximum Extended Load Line Limit Plus License Amendment Request (EPID L-2018-LLA-0048)," December 6, 2018.
2. ANP-10298PA Revision 0, *ACE/ATRIUM 10XM Critical Power Correlation*, AREVA NP, March 2010.
3. ANP-3140(P) Revision 0, *Browns Ferry Units 1, 2, and 3 Improved K-factor Model for ACE/ATRIUM 10XM Critical Power Correlation*, AREVA NP, August 2012.
4. ANP-3656P Revision 1, *Framatome Additional Information for Browns Ferry MELLLA+*, Framatome Inc., February 2018.

ENCLOSURE 5

**Responses to SRXB RAI-5, SNPB RAI-4, SRXB-C RAI-1, SRXB-C RAI-2, SRXB-C
RAI-3, SRXB-C RAI-4, and SRXB-C RAI-5
(Non-proprietary)**

SRXB RAI-5

Attachment 33 of the LAR contains the basis for feedwater temperature reduction for input into the TRACG ATWS-I analysis. The data was based on a turbine trip event at BFN, Unit 3. To ensure the model adequately models the transient to meet the 10 CFR 50.62 acceptance criteria:

- a. Provide the basis for the 39,800 lbm used in the calculation which determined the 14 seconds delay time.*
- b. Justify that the 14 seconds delay time is bounding relative to the turbine trip event data for BFN, Unit 3.*
- c. Explain why the feedwater temperature reduction rate changes during the turbine trip event at BFN, Unit 3 (Step 1, Step 2, and Step 3) and please discuss why this is bounding for ATWS-I.*
- d. Please compare the TRACG feedwater temperature input to ATWS simulator data to demonstrate that the feedwater temperature used in the analysis is conservative.*
- e. Please provide justification that this basis is also applicable to the feedwater temperature reduction for the 2RPT event.*

TVA Response

- a. The 39,800 lbm value for the mass of water between the outlet of the last stage feedwater (FW) heaters and the reactor was extracted from FW mass and temperature data used in the long-term containment response analysis presented in Section 2.6 of Reference 1 in support of the TVA License Amendment Request (LAR) for Extended Power Uprate (EPU). This FW mass and temperature data is shown in Table SRXB RAI-5a-1 of this RAI response. The 39,800 lbm value is shown in Table SRXB RAI-5a-1 as the fluid mass between the reactor pressure vessel (RPV) and the #1 heater datum entry. Note that none of the Table SRXB RAI-5a-1 FW mass and temperature data change for the Browns Ferry Nuclear Plant (BFN) Maximum Extended Load Line Limit Analysis Plus (MELLLA+) LAR.

Reference

1. NEDC-33860P, Revision 1, Safety Analysis Report for Browns Ferry Nuclear Plant Units 1, 2, and 3 Extended Power Uprate - (Proprietary version), Enclosure 1 to TVA letter to NRC dated October 28, 2016, "Proposed Technical Specifications (TS) Change TS-505 - Request for License Amendments - Extended Power Uprate (EPU) - Supplement 35, Consolidated Power Uprate Safety Analysis Report Revision," (ADAMS Accession No. ML16302A441).

- b. Observation of the data for the turbine trip event for BFN Unit 3 provided in Attachment 33 of the BFN MELLLA+ LAR shows that FW temperature begins to reduce from the initial steady-state value at approximately 60 seconds following the turbine trip. FW flow reduces during this initial part of the BFN Unit 3 turbine trip event to approximately 4 Mlbm/hr. The delay time for the onset of FW temperature reduction is inversely proportional to the FW flow rate because a higher FW flow rate will result in a faster displacement of hot FW with cooler FW from the lower-pressure FW heating stages.

Initial steady-state conditions for a turbine trip with bypass (TTWBP) Anticipated Transient Without Scram with core instability (ATWS-I) event are 100% rated thermal power (3952 MWt) with initial core flow of 85% of rated core flow. FW flow at these initial conditions is 16.4 Mlbm/hr. Upon receipt of a turbine trip with failure to scram, pressurization of the reactor will cause the reactor recirculation pumps to trip due to an ATWS-Recirculation Pump Trip (ATWS-RPT) high pressure signal. Tripping of the reactor recirculation pumps will cause reactor power to runback to natural circulation conditions, approximately 62% of rated thermal power. Since FW flow is proportional to reactor power, FW flow will also reduce to approximately 62%. This is shown graphically in Figure SRXB RAI-5b-1.

Factoring the product of the BFN Unit 3 turbine trip delay time (60 seconds) and the BFN Unit 3 turbine trip FW flow (approximately 4 Mlbm/hr) by the MELLLA+ FW flow at reactor natural circulation conditions (rated FW flow of 16.4 Mlbm/hr x 62%) results in a delay time of $((60\text{second} \cdot 4\text{Mlbm/hr}) / (16.4\text{Mlbm/hr} \cdot 62\%)) = 23.6$ seconds. Therefore, the 14 second delay time used in the TTWBP ATWS-I analysis is bounding relative to the delay time calculated from the BFN Unit 3 turbine trip data.

The above computation assumes an instantaneous reduction in core flow and a corresponding instantaneous reduction in FW flow from 100% of rated to 62% of rated upon trip of the recirculation pumps. In actual plant operation, the core flow reduction and the corresponding FW flow response is not instantaneous; core flow, power and FW flow reach steady-state conditions about 30 seconds after the recirculation pumps trip. During this 30 second time period, the average FW flow is approximately 73% of rated FW flow. Factoring the product of the BFN Unit 3 turbine trip delay time (60 seconds) and the BFN Unit 3 turbine trip FW flow (approximately 4 Mlbm/hr) by the average FW flow following the reactor recirculation pump trip (rated FW flow of 16.4 Mlbm/hr x 73%) results in a delay time of $((60\text{second} \cdot 4\text{Mlbm/hr}) / (16.4\text{Mlbm/hr} \cdot 73\%)) = 20$ seconds. Therefore, the 14 second delay time used in the TTWBP ATWS-I analysis is bounding relative to the delay time calculated from the BFN Unit 3 turbine trip data.

As an independent means of validating the FW temperature reduction delay and rate terms used in the BFN MELLLA+ TTWBP ATWS-I analysis, TVA performed BFN simulator runs of TTWBP with ATWS initiated at initial conditions of 3952 MWt and 85% core flow. Two sets of simulator runs were performed: 1) no operator action during the event and 2) operator action to terminate FW injection in order to reduce reactor water level at approximately 45 seconds following event initiation. FW temperature reduction for these simulator runs as well as the TTWBP ATWS-I analysis FW temperature reduction are shown in Figure SRXB RAI-5b-2. As shown in Figure SRXB RAI-5b-2, the FW temperature delay time and temperature reduction rates used in the BFN TTWBP ATWS-I analysis bound the simulator results. This provides added confidence that the TTWBP FW temperature reduction input to ATWS-I analysis is conservative.

- c. The FW heater system for each BFN unit consists of five stages of FW heating. Each FW heating stage consists of three parallel trains of FW heaters. The highest pressure FW heating stage is designated as Stage 1 and the lowest pressure heating stage is Stage 5. The Stage 5 FW heating stage has its drain cooler contained in a separate pressure vessel. FW flow passes through U-tube bundles in the FW heaters. Drain flow from the condensed steam in each FW heater is cascaded through lower stage FW heaters back to the main condenser. Control valves in the drain lines of each FW heater regulate drain flow from each FW heater in order to maintain a constant level in each FW heater. The exhaust steam from the main turbine high-pressure section passes through moisture separators prior to entering the main turbine low-pressure sections. The steam supply for each FW heater is extracted from various stages of the main turbine and enters the shell sides of the FW heaters. A simplified diagram of the FW heater system is shown in Figure SRXB RAI-5c-1. As shown in Figure SRXB RAI-5c-1, the Stage 1 FW heaters are supplied by high-pressure turbine exhaust steam/steam supply to the moisture separators and the Stage 2 FW heaters are supplied by extraction steam from the low-pressure turbines as well as drain flow from the moisture separators.

FW heating in each FW heater occurs through three mechanisms: 1) heat transfer due to the phase change from saturated steam to saturated liquid of the extraction steam supplied to the heater shell, 2) heat transfer due to subcooling of the condensed steam in the drain cooler section and 3) heat transfer from the latent heat of the metal mass of the FW heater shell. Heat transfer due to the phase change of the extraction steam in the FW shell is the largest contributor to FW heating during normal plant operation.

Upon a turbine trip, the main turbine stop valves fast-close to isolate the reactor steam supply to the high pressure turbine and the main turbine combined-intermediate valves fast-close to isolate the low pressure turbine steam supply from the moisture separators. The high pressure FW heaters (Stage 1 and Stage 2 FW heater strings) will continue to receive steam from entrapped steam in the moisture separators until moisture separator pressure is no longer greater than the Stage 1 and Stage 2 FW heater pressures. Therefore, after a turbine trip, there remains a significant quantity of steam available for FW heating. The low pressure heaters (Stage 3, Stage 4 and Stage 5) shell sides will depressurize more quickly than the high pressure heaters because the only steam available after a turbine trip is the entrapped steam in the FW heater shells and extraction steam lines as well as cascaded drain flow, which flashes to steam, from downstream, higher pressure, FW heaters.

The rate changes of FW temperature reduction shown in Attachment 33 of the BFN MELLLA+ LAR are as expected: initial lower rate change of FW temperature reduction followed by increasing rate changes. Step 1 shown in Attachment 33 is soon after the turbine trip. During Step 1, there is still significant steam available, supplied by the main turbine moisture separators, in the high-pressure FW heat shells for FW heating. This will dampen (reduce) the rate of FW temperature reduction as lower-temperature FW from the low pressure heaters displaces the initial, higher-temperature FW. The larger FW temperature reduction rates for Steps 2 and 3 shown in Attachment 33 of the MELLLA+ LAR are due to the reduction in available energy from the steam in the high pressure FW heater shells as the supply steam from moisture separators is depleted. In Figure SRXB RAI-5c-2 of this RAI, additional data from the BFN U3 turbine trip event are plotted to show individual FW heater outlet temperatures, moisture separator/HP turbine exhaust pressure and individual FW shell-side steam pressures.

For the simulation of the TTWBP ATWS-I event, the time frame of interest for FW temperature reduction is only for the first 2-3 minutes following the turbine trip because reactor instabilities are effectively terminated following the operator action to reduce FW flow to the RPV (at 120 seconds in the TTWBP ATWS-I simulation). Therefore, engineering judgement was used to only utilize data from the first three steps of FW injection during the BFN Unit 3 turbine trip event to determine FW temperature reduction rates extrapolated to MELLLA+ FW flow conditions. As described in Attachment 33 of the MELLLA+ LAR, the Step 1 FW temperature reduction rate of 0.4°F/second was not used as an input to the TTWBP ATWS-I event simulation in order to provide some additional conservatism in the FW temperature reduction rate input. However, TVA did not desire to provide an overly conservative input. For this reason, the BFN Unit 3 turbine trip Step 2 calculated FW temperature reduction rate of 1.1°F/second was considered to be both conservative and reasonable as input for the first minute in the ATWS-I analysis following the FW temperature delay time of 14 seconds. Use of the Step 3 FW temperature reduction rate of 1.4°F/second was considered as conservative and reasonable based on review of the BFN Unit 3 turbine trip data extrapolated to MELLLA+ FW flow conditions. As described in part b to this RAI response, data from the TVA plant simulator runs provide added confidence that the FW temperature reduction rates used in the TTWBP ATWS-I analysis bound the actual BFN plant response.

Feedwater Temperature Change per Unit Mass

During a high power ATWS event, the reactor will continue to operate at a reactor power as high as 62% of rated after the recirculation pumps are tripped. In the TTWBP ATWS-I event, a significant volume of FW is expected to be pumped to the RPV until the operators terminate FW injection at 120 seconds. This is in contrast to a plant scram from high power, such as the 2004 BFN Unit 3 turbine trip event shown in Attachment 33 of the BFN MELLLA+ LAR, where the demand for FW is low. To provide an additional means for comparison, the temperature data from the 2004 BFN Unit 3 turbine trip event were plotted as a function of the mass pumped to the RPV. The goal of the mass flow versus temperature comparison is to establish a measurement of FW system heat removal that is independent of the rate that heat is removed from the system thereby providing a direct comparison between the 2004 BFN Unit 3 turbine trip event and a hypothetical ATWS-I scenario.

Based on rated FW flow (i.e., 16.4 Mlbm/hr) and assuming 62% power (i.e., reactor power at reactor natural circulation), the mass of FW required during the first 120 seconds of a high-power ATWS event is just under 339,000 lbm. Figure SRXB RAI-5c-3 shows the change in FW temperature on a per unit mass basis for the 2004 BFN Unit 3 turbine trip event compared to the change in FW temperature on a per unit mass basis for the assumed FW temperature reduction used in the BFN TTWBP ATWS-I event. Observation of the data plotted in Figure SRXB RAI-5c-3 provides additional confidence that the assumed FW temperature reduction rate used in the BFN TTWBP ATWS-I analysis bounds the expected BFN plant response. As noted in part b of this RAI response, the power reduction and corresponding FW flow reduction to natural circulation conditions is not instantaneous. This would result in a slightly higher mass of FW injected during the first 120 seconds of a high-power ATWS event. However, this larger mass of FW injection does not alter the conclusion drawn from Figure SRXB RAI-5c-3 that the assumed FW temperature reduction rate used in the BFN TTWBP ATWS-I analysis bounds the expected BFN plant response.

- d. For the TTWBP ATWS-I event, comparisons of the TRACG FW temperature input to ATWS simulator data are shown in part b of this RAI response. For the 2-recirculation pump trip (2RPT) ATWS-I event, comparisons of the TRACG FW temperature input to ATWS simulator data are shown in part e of this RAI response. The comparisons for both events show that the TRACG FW temperature inputs are conservative versus BFN simulator results.
- e. For the 2RPT ATWS-I event, the FW temperature reduction rate is much milder than for the TTWBP event. This is because the main turbine remains on-line during the 2RPT event and extraction steam to the FW heaters is not isolated as a result of a turbine trip. The assumed FW temperature is modeled consistent with 2RPT TRACG runs supporting reactor thermal-hydraulic stability analyses presented in M+SAR section 2.4. For 2RPT, FW temperature reduction is modeled by using the relationship between turbine steam flow and FW enthalpy. This relationship is incorporated into TRACG via a lookup table. Changes in FW enthalpy (and FW temperature) are assumed to lag turbine steam flow with a 60-second time constant. This methodology for FW temperature reduction is consistent with that used by GEH in the simulation of 2RPT ATWS-I events at other plants that have applied for the MELLLA+ operating domain extension.

As an independent means of validating the FW temperature reduction used in the BFN MELLLA+ 2RPT ATWS-I analysis, TVA performed BFN simulator runs of 2RPT with ATWS initiated at initial conditions of 3952 MWt and 85% core flow. Two sets of simulator runs were performed: 1) no operator action during the event and 2) Operator action to terminate FW injection in order to reduce reactor water level at approximately 81 seconds following event initiation. FW temperature reduction for these simulator runs as well as the 2RPT ATWS-I analysis FW temperature reduction are shown in Figure SRXB RAI-5e-1. As shown in Figure SRXB RAI-5e-1, the FW temperature reduction used in the BFN 2RPT ATWS-I analysis bound the simulator results. This provides added confidence that the 2RPT FW temperature reduction input to the ATWS-I analysis is conservative.

RPV		Resolved Values		
			Fluid	Metal
		Temp (°F)	Mass (lbm)	Mass (lbm)
		394.3	39,800	217,592
#1 Heater		394.3	35,400	236,100
		343.5	445	6,270
#2 Heater		343.5	35,400	224,400
		311.2	50,800	169,777
RFP		311.2	12,500	37,350
		309.5	33,100	57,978
#3 Heater		309.5	53,400	226,500
		248.5	28,500	31,034
#4 Heater		248.5	47,400	262,200
		191.0	5,550	5,911
#5 Heater		191.0	42,900	210,750
#5 Flash Tank				28,950
		157.6	5,550	3,448
#5 Drain Cooler		157.6	24,000	167,100
		124.1	38,100	76,217
Condensate booster pumps		124.1	12,500	21,348
		124.1	13,333	67,604
Demineralizers		124.1	12,500	76,500
		124.1	13,333	25,230
Off-Gas condenser		124.1	12,500	14,400
SPE				8,000
SJAE				21,600
		123.4	13,333	52,563
Condensate pumps		123.4	55,200	81,600
		123.4	126,900	54,315
Condenser Hotwell		123.4	1,175,100	4,500,000

TABLE SRXB RAI-5a-1 – FW Mass and Temperature Data (120% OLTP)

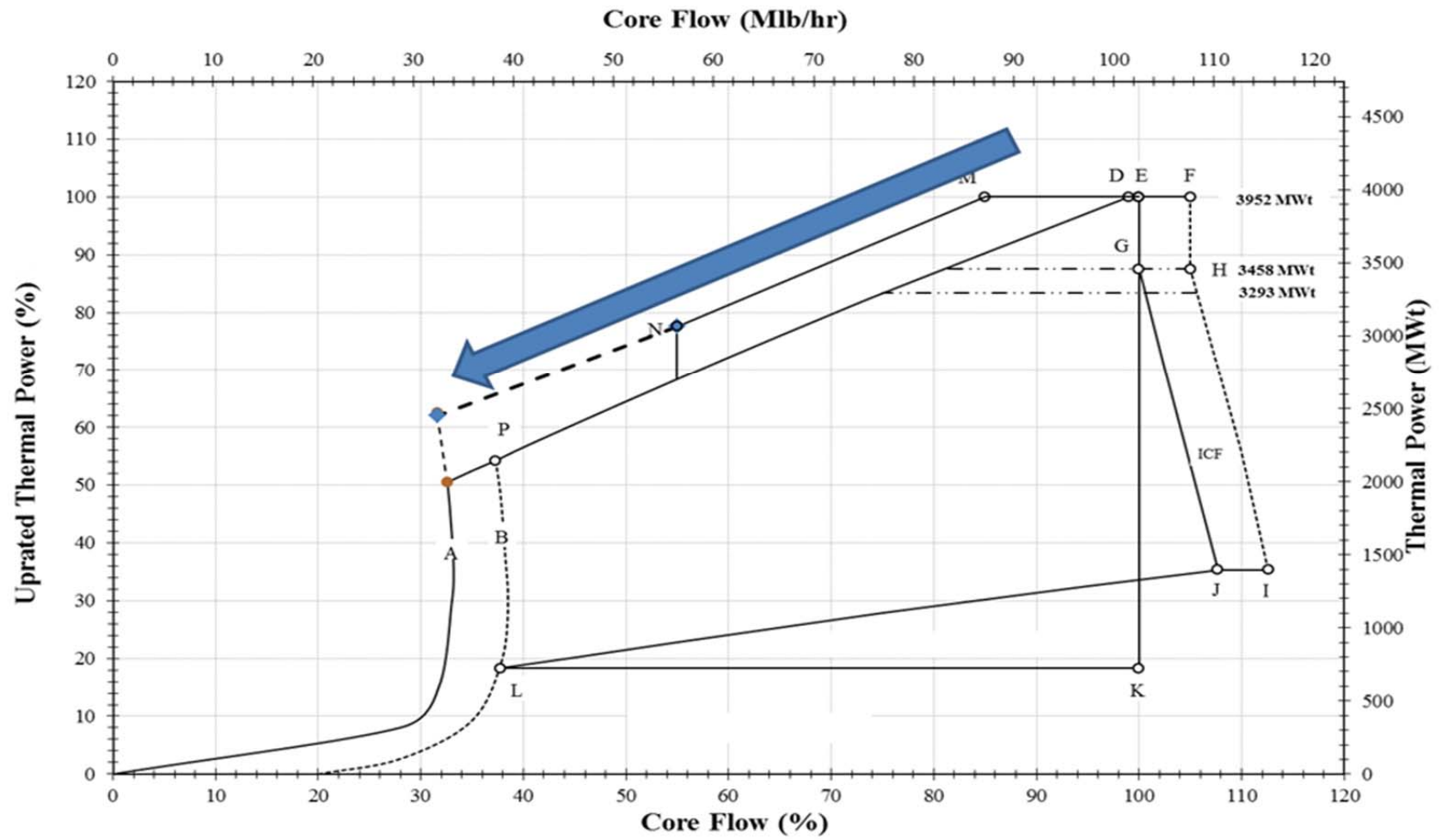

Figure SRXB RAI-5b-1

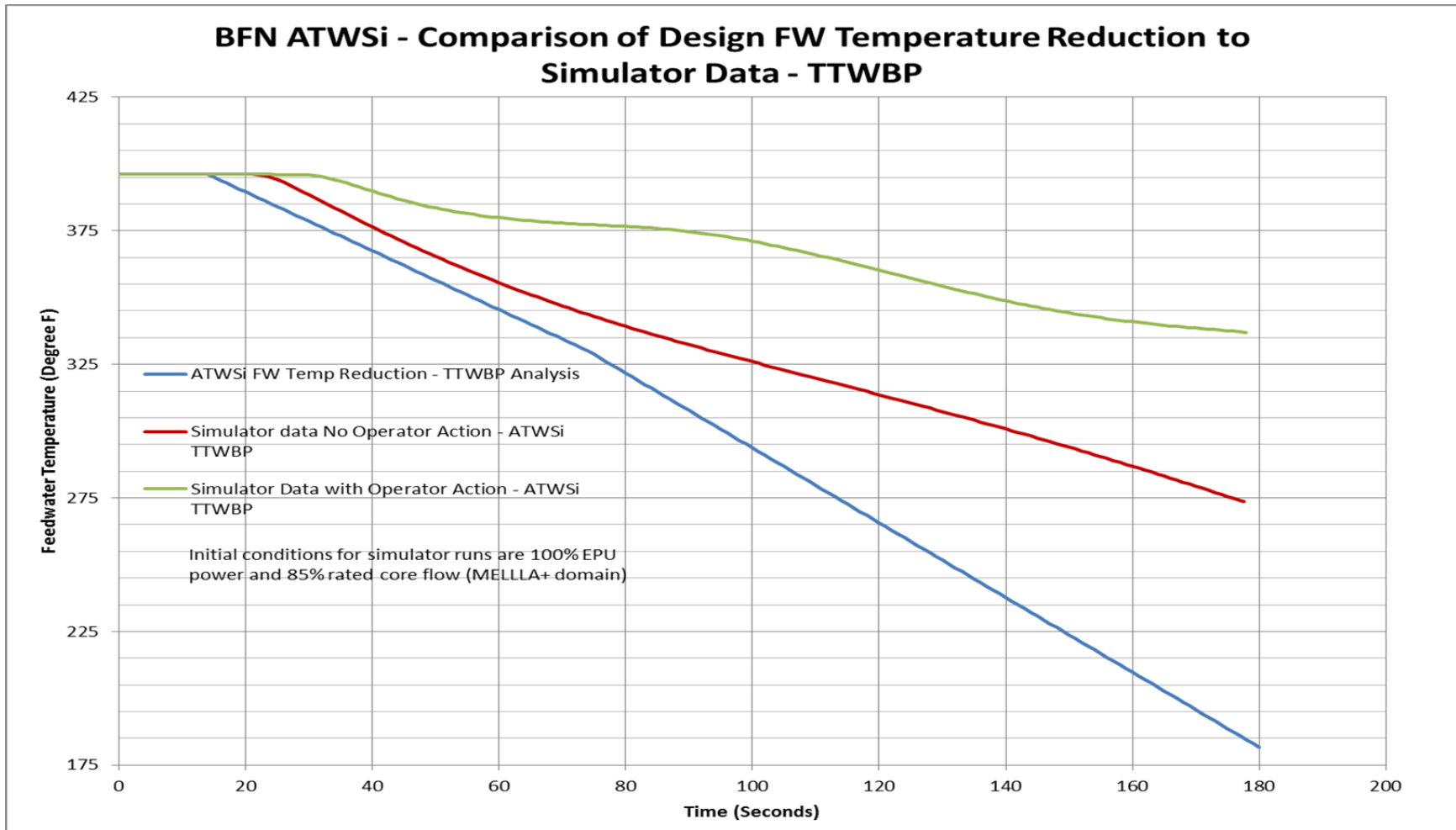

Figure SRXB RAI-5b-2

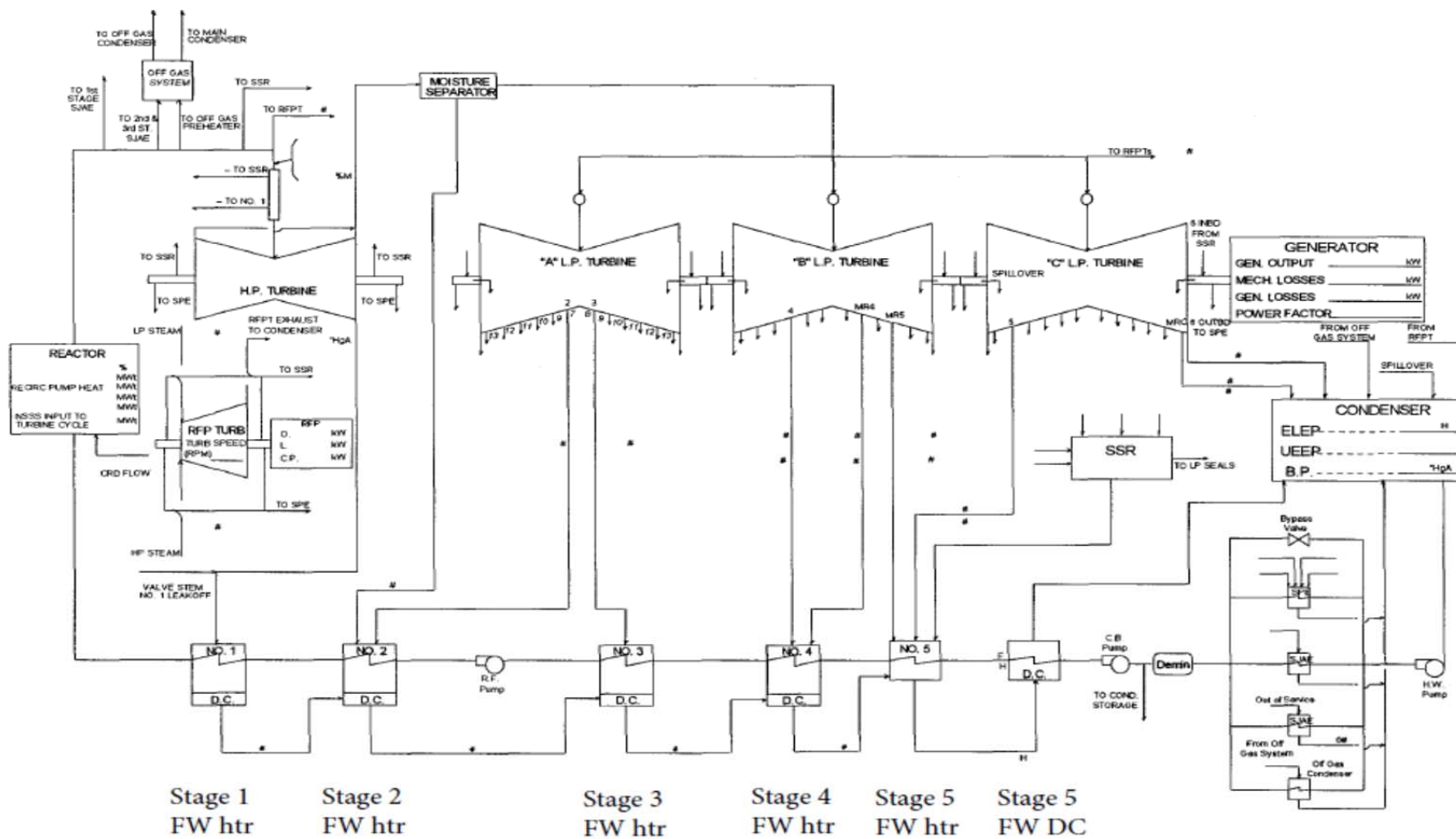

Figure SRXB RAI-5c-1

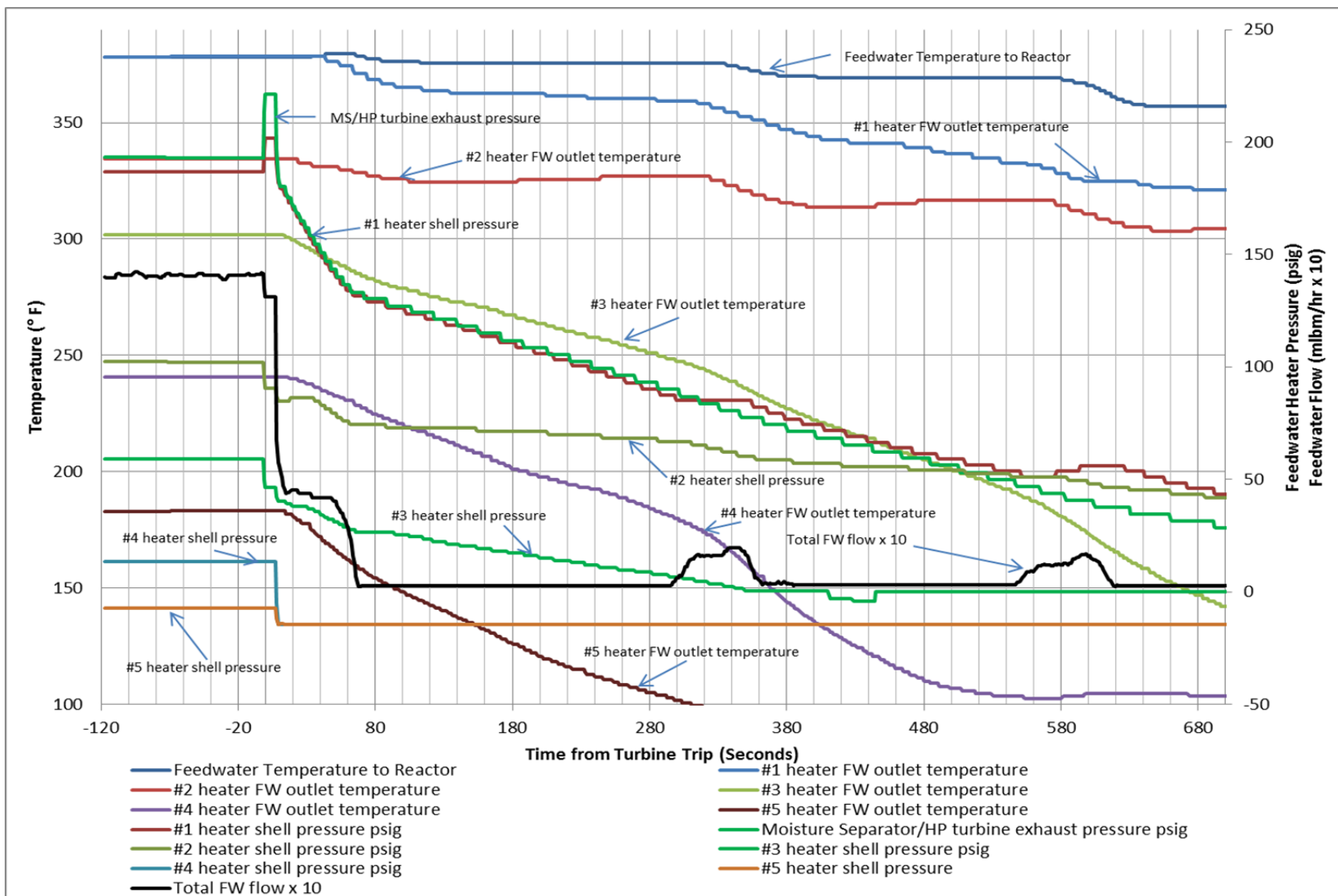

Figure SRXB RAI-5c-2

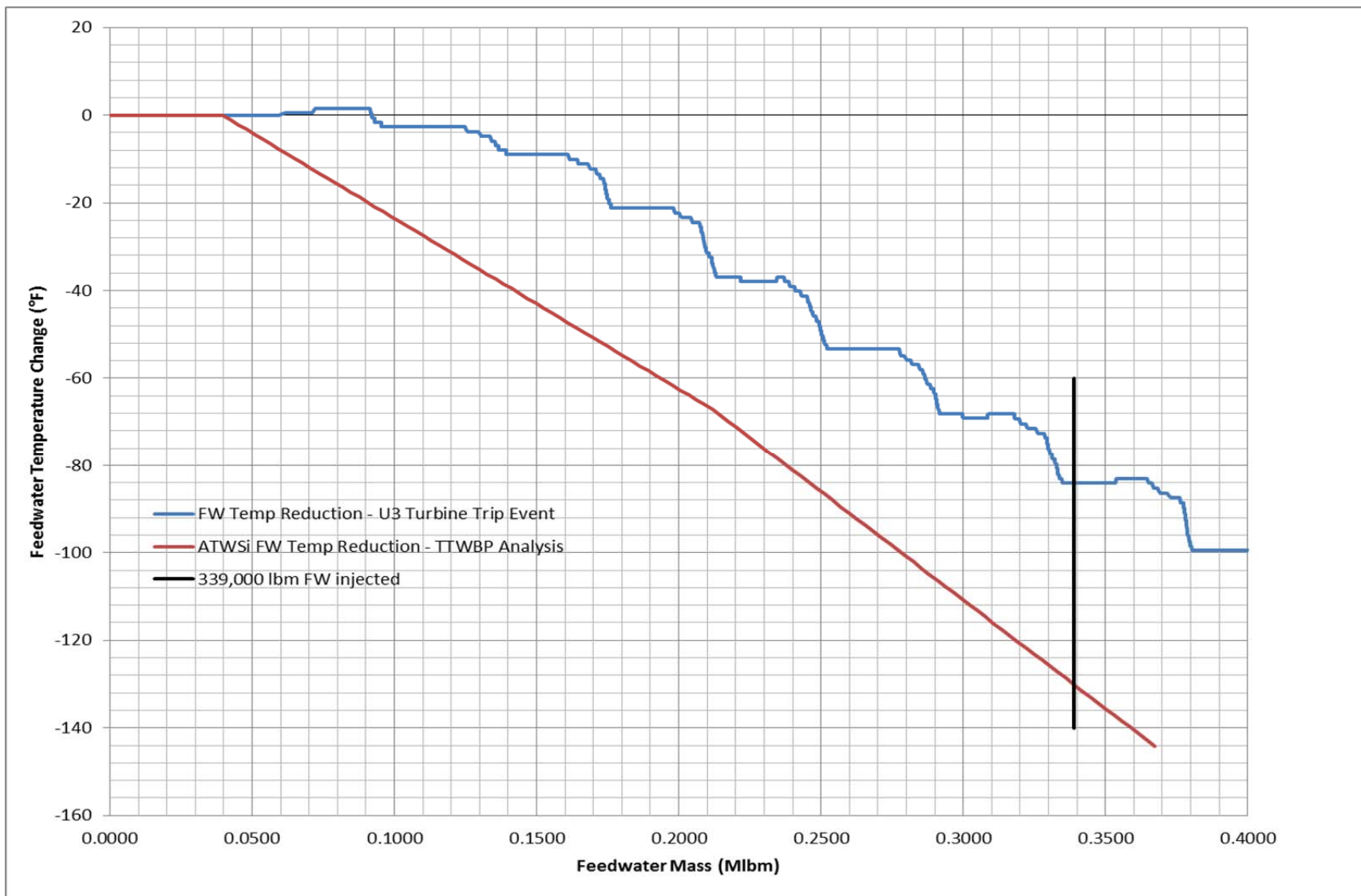

Figure SRXB RAI-5c-3

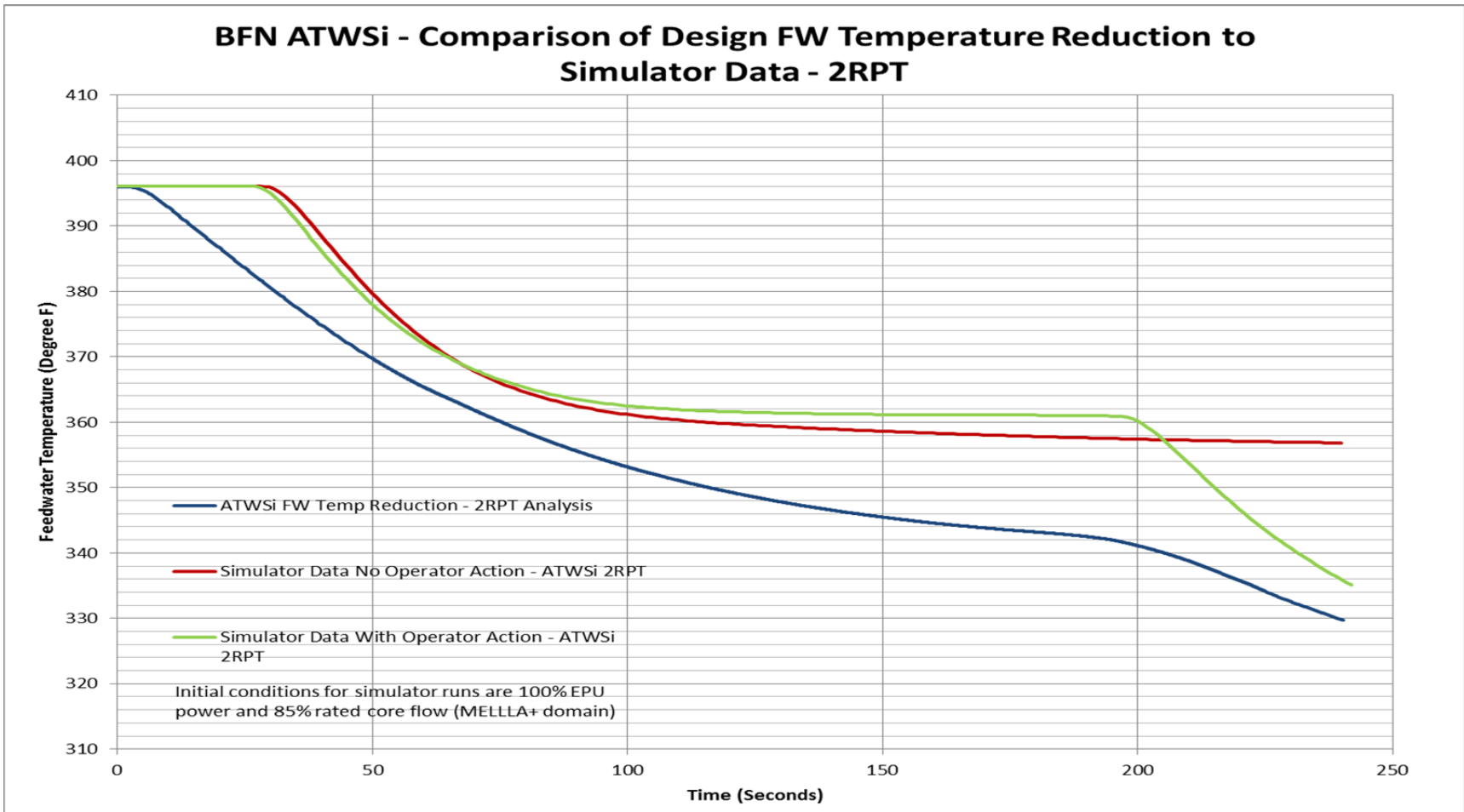

Figure SRXB RAI-5e-1

SNPB RAI-4

ANP-3550 (Reference 9) Section 3.0 states that for the control rod drop analysis (CRDA) the deposited enthalpy must be < 280 calories per gram (cal/g), which is used to demonstrate compliance with draft GDC 32. Since the publication of Regulatory Guide (RG) 1.77, "Assumptions Used for Evaluating a Control Rod Ejection Accident for Pressurized Water Reactors" (Reference 10), the acceptance criteria of 280 cal/g has been determined to be inadequate to ensure fuel rod geometry and long-term coolability. The NRC staff documented its position on RG 1.77 in a letter dated April 3, 2015, "Results of Periodic Review of Regulatory Guide 1.77" (Reference 11). The position is supported by a guidance document dated January 19, 2007, titled "Technical and Regulatory Basis for the Reactivity-Initiated Accident Interim Acceptance Criteria and Guidance" (Reference 12).

An analysis for demonstrating acceptance to draft regulatory guide (DG) 1327 is provided in ANP-3633 (Reference 13), however, the LAR states that the DG-1327 is not included in the BFN licensing basis. Since the staff has determined that the 280 cal/g is non-conservative and since it is stated that DG-1327 is not part of the licensing basis, discuss what acceptance criteria will be used if it is necessary to reanalyze the CRDA event (e.g., an error is found in the analysis).

References

9. ANP-3550NP, Revision 0 (Attachment 26 of LAR), "Evaluation of AREVA Fuel Thermal-Hydraulic Performance for Browns Ferry at EPU MELLLA+," dated March 2017 (ADAMS Accession No. ML180799140)
10. U.S. RG 1.77, "Assumptions Used for Evaluating a Control Rod Ejection Accident for Pressurized Water Reactors," dated May 1974 (ADAMS Accession No. ML003740279).
11. U.S. NRC Memorandum, "Results of Periodic Review of Regulatory Guide 1.77," dated April 3, 2015 (ADAMS Accession No. ML15075A311)
12. U.S. NRC Memorandum, "Technical and Regulatory Basis for the Reactivity-Initiated Accident Interim Acceptance Criteria and Guidance," dated January 19, 2007 (ADAMS Accession No. ML070220400)
13. ANP-3633NP, Revision 1 (Attachment 32 of LAR), "Browns Ferry EPU MELLLA+ CRDA Assessment with DG 1327 Criteria," dated January 2018 (ADAMS Accession No. ML180799140)

TVA Response

The consequences of a Control Rod Drop Accident (CRDA) have been evaluated by TVA and Framatome as part of the BFN MELLLA+ LAR. The acceptance criteria applied to this evaluation are based on draft GDC-32, insofar as it requires that limits, which include considerable margin, be placed on the maximum reactivity worth of control rods or elements and on rates at which reactivity can be increased to ensure that the potential effects of a sudden or large change of reactivity cannot (a) rupture the reactor coolant pressure boundary or (b) disrupt the core, its support structures, or other vessel internals sufficiently to impair the effectiveness of emergency core cooling.

The BFN MELLLA+ CRDA evaluation documented in Attachment 7 of the MELLLA+ LAR assumed an equilibrium cycle core loading of ATRIUM 10XM fuel, and the representative Reload Safety Analysis Report (RSAR) CRDA evaluation documented in Attachment 17 of the MELLLA+ LAR assumed a transition cycle core loading consisting of ATRIUM 10XM fuel and co-resident ATRIUM-10 fuel. The evaluations were performed using the NRC approved Framatome methods described in XN-NF-80-19(P)(A). The acceptance criteria for this approved methodology are peak fuel enthalpy less than 280 cal/gram and less than 850 rod failures to maintain the Alternate Source Term radiological assessment valid. However, given the fact that the acceptance criteria of 280 cal/gram has been found by the NRC to be inadequate to ensure fuel rod geometry and long term coolability, the interim acceptance criteria provided by the NRC in its 2007 guidance document entitled "Technical and Regulatory Bases for the Reactivity-Initiated Accident Interim Acceptance Criteria and Guidance," specifically limiting the peak radial average fuel enthalpy below 230 cal/gram, has been applied as the acceptance criteria for these evaluations in lieu of the original 280 cal/gram criterion. Any MELLLA+ CRDA evaluation results with peak enthalpy greater than 230 cal/gram but less than the original 280 cal/gram criterion would have been considered by TVA and Framatome to be unacceptable. This is also true for subsequent CRDA evaluations performed by Framatome for BFN. Furthermore, any fuel rods found to exceed an enthalpy value of 170 cal/gram are assumed to fail. However, having established this reduced enthalpy acceptance criteria for the BFN CRDA evaluation, it should be noted that NRC Research Information Letter 0401, dated March 31, 2004, (ML040920167) states that, based on available data, the NRC's assessment of postulated Reactivity-Initiated Accidents (RIAs) for operating reactors concluded that it is very unlikely for a control rod worth in a US power reactor to exceed the enthalpy limits necessary to cause fuel dispersal in high-burnup fuel (calculated to be \$1.5) and therefore the current operating reactors are not likely to experience cladding failure during the worst postulated RIAs, and without cladding failure, coolable geometry is ensured and steam explosions cannot occur.

The results of the BFN MELLLA+ CRDA evaluations are summarized in the table below:

	ATRIUM 10XM Equilibrium Cycle	Representative Transition Cycle	Criteria
Peak Fuel Enthalpy (cal/g)	145.4	156.2	< 230 cal/g
Number of Failed Rods	0	0	< 850 (number of rods exceeding 170 cal/g)

The calculated peak fuel enthalpy for the hottest rod in either the equilibrium cycle or the transition cycle is 156.2 cal/gram, which is below the interim acceptance limit of 230 cal/gram or the assumed fuel failure threshold of 170 cal/gram. Thus, no failed fuel rods are predicted and the acceptance criteria are satisfied. Therefore, the draft GDC-32 criteria are satisfied.

Additionally, TVA and Framatome have performed an informational CRDA evaluation based on the draft regulatory guide DG-1327 in order to assess the impact of the proposed acceptance criteria of DG-1327 in the startup range if it were to be implemented during BFN MELLLA+ operation. This additional evaluation is included as Attachment 31 in the BFN MELLLA+ LAR and includes the pellet-cladding mechanical interaction criteria that addresses fuel failures due to pellet clad mechanical interaction (PCMI), high temperature failure threshold, and rod failure assessment. The evaluation was performed using a combination of approved Framatome methodologies as well as components of methods that were not yet part of the Framatome NRC approved methodologies at the time of LAR submittal. In summary, it was found that (1) maintaining the current Framatome adiabatic enthalpy less than 230 cal/g supports the

conclusion that fuel melt will not occur. Therefore, fuel coolability is maintained and fuel failures will not occur due to the proposed fuel melt criterion, (2) the actual number of rod failures will increase with the lower failure thresholds, however it is unlikely that the increase in the number of rod failures will exceed the BFN CRDA current licensing basis dose calculations, and (3) it is not possible to exceed the regulatory dose limits for a control rod drop at BFN due to the localized nature of the event and the margin to the regulatory limit.

The effects of fuel burnup were considered in the DG-1327 assessment. The fuel melt evaluation considered the exposure dependence of the fuel pellet radial power distribution due to plutonium buildup near the pellet rim. The PCMI failure evaluation considered burnup effects by evaluating hydrogen pickup in the clad as a function of fuel burnup and power history. The high cladding temperature failure evaluation also considered burnup effects by modeling the fuel rod internal pressure as a function of power history, power level, and irradiation time. Therefore, the effects of fuel burnup were appropriately accounted for.

It can therefore be concluded that continued evaluation of BFN reload cycles at the proposed MELLLA+ conditions with the currently approved Framatome methodology, using the interim peak fuel enthalpy acceptance limit of 230 cal/gram with the assumed fuel failure threshold of 170 cal/gram, will continue to ensure that the BFN licensing basis requirements and dose limits are met. It can further be concluded that BFN will be able to comply with the proposed new acceptance criteria contained in draft regulatory guide DG-1327 for the CRDA at MELLLA+ conditions when it is approved in the future.

SRXB-C RAI-1

10 CFR 50.49(e)(1) states that the time-dependent temperature and pressure at the location of the electric equipment important to safety must be established for the most severe design basis accident (DBA) during or following which this equipment is required to remain functional.

Section 4.1.1 of MELLLA+ Safety Analysis Report (M+SAR), NEDC-33877P, Revision 0, for proprietary and NEDO-33[8]77NP for non-proprietary versions (Reference 4) states that the current long-term analysis for small steam line break (SSLB) accident for evaluation of drywell equipment qualification (EQ) produced a significantly high peak drywell temperature of 336.9 degrees Fahrenheit (°F) and an elevated drywell atmosphere temperature response that lasts for a much longer duration than produced by the short-term recirculation suction line break (RSLB) accident analysis. It is further stated that the peak predicted drywell shell temperature produced by the current SSLB analyses of 280.8°F is bounded by the drywell shell design limit of 281°F. Provide the results of the drywell gas temperature response and the peak drywell shell temperature for the SSLB accident in the MELLLA+ operating domain.

Reference

4. *NEDO-33877, Revision 0 (Attachment 6 of LAR), "Safety Analysis Report for Browns Ferry Nuclear Plant Units 1, 2, and 3 Maximum Extended Load Line Limit Plus," dated February 2018 (ADAMS Accession No. ML180576276)*

TVA Response

For the SSLB, Maximum Extended Load Line Limit Analysis Plus (MELLLA+) does not result in a change in the break energy or break flow because 1) break sizes do not change and 2) MELLLA+ does not result in a change in reactor power nor reactor pressure, therefore, the enthalpy of the steam does not change. Consequently, the drywell gas temperature and the peak drywell shell temperature responses for the SSLB accident reported for Extended Power Uprate (EPU) do not change for MELLLA+. No additional analyses were performed for the SSLB in the MELLLA+ operating domain. A BFN plant specific MELLLA+ analysis of the containment response for the SSLB would have no changes from the EPU (MELLLA domain) containment response analyses.

SRXB-C RAI-2

Draft GDC 10 and 49, as they relate to the containment being designed with sufficient margin, require that the containment and its associated systems can accommodate, without exceeding the design leakage rate and with sufficient margin, the calculated pressure and temperature conditions resulting from any loss-of-coolant accident (LOCA).

Section 4.1.1.1 of M+SAR (Reference 4) states:

In addition, there is no change as a result of the MELLLA+ operating domain expansion to other key long-term containment response parameters reported in Reference 16 [Reference 3 of this document] including drywell atmosphere temperature and drywell shell temperature response, wetwell temperature and wetwell pressure response, and steam bypass capability. No further evaluation of

these long-term containment response parameters is therefore required for MELLLA+.

Provide reasons why the parameters stated above are not affected by the MELLLA+ operating domain. In case the reason is the long-term decay heat is not changed in the MELLLA+ operating domain, please justify these parameters solely depend on decay heat.

Reference

4. NEDO-33877, Revision 0 (Attachment 6 of LAR), "Safety Analysis Report for Browns Ferry Nuclear Plant Units 1, 2, and 3 Maximum Extended Load Line Limit Plus," dated February 2018 (ADAMS Accession No. ML180576276)

TVA Response

The purpose of the statement in Section 4.1.1.1 of the M+SAR was to provide to the NRC a definitive statement that all long-term containment analysis response results (in addition to the suppression pool temperature response) reported in Section 2.6 of Reference 3 remain unaffected by the MELLLA+ operating domain expansion.

The long-term containment response for drywell atmosphere temperature and drywell shell temperature response, wetwell temperature and wetwell pressure response are affected by the reactor power level, containment initial conditions, sensible heat and decay heat. For MELLLA+, there are no changes to any of these parameters. The sensible heat input to the long-term containment analyses is affected by initial reactor pressure and power level, which do not change for MELLLA+. Containment initial conditions for long-term analyses do not change for MELLLA+.

Steam bypass capability at the EPU power level was performed in Reference 3 based upon the containment response to steam line breaks. Operation within the MELLLA+ domain does not change the mass and energy releases for steam line breaks (see response to SRXB-C RAI-1), the containment initial conditions, operator actions and timing, or containment cooling capability.

Reference

3. GE Hitachi Nuclear Energy, "Safety Analysis Report for Browns Ferry Nuclear Plant Units 1, 2, and 3 Extended Power Uprate," NEDC-33860P, Revision 1, October 2016.

SRXB-C RAI-3

Draft GDC 40 and 42, insofar as they require that protection be provided for engineered safety features against the dynamic effects that might result from plant equipment failures, as well as the effects of a LOCA.

In order to meet the above requirement of draft GDC 40 and 42, it is necessary to assure that the vent thrust loads, which is one of the categories of dynamic loads imposed on the containment and its internal SSCs, during a LOCA in the MELLLA+ operating domain is within the design limits and the SSCs are adequately protected.

Section 4.1.2.1 of M+SAR, under the heading "Vent Thrust Loads" states:

Vent thrust loads are calculated using the equations documented in the LDR (Reference 31 [Reference 6 of this document]) at MELLLA+ conditions, based on the DBA-LOCA results obtained with the GEH [General Electric Hitachi] M3CPT code.

Explain how the MELLLA+ vent thrust loads were calculated based on the design basis accident (DBA)-LOCA results using the equations in Reference 6, and which DBA-LOCA results were used.

Reference

6. *GE Nuclear Energy, NEDO-21888, Revision 2, "Mark I Containment Program Load Definition Report," November 1981*

TVA Response

The pressure differentials and the mass flow rates at the limiting time instants (at the vent clearing time, when the pressure differential between the drywell and wetwell is maximum, and when the mass flow rates are maximum) are obtained from the M3CPT output. These values, along with the geometry inputs for the vent system (which do not change for MELLLA+) are substituted in the equations in Section 4.2.1 of the LDR. These calculations are performed in Microsoft Excel™ and are equivalent to hand calculations.

SRXB-C RAI-4

Draft GDC 40 and 42, insofar as they require that protection be provided for engineered safety features against the dynamic effects that might result from plant equipment failures, as well as the effects of a LOCA.

In order to meet the above requirement of draft GDC 40 and 42, it is necessary to assure that the pool swell loads, which is one of the categories of dynamic loads imposed on the containment and its internal SSCs, during a LOCA in the MELLLA+ operating domain is within the design limits and the SSCs are adequately protected.

Section 4.1.2.1 of M+SAR, under the heading "Pool Swell Loads" states:

II

JJ^[1]

As stated in Section 2.6.1 of NEDC-33860P, Revision 1, "Safety Analysis Report for Browns Ferry Nuclear Plant Units 1, 2, and 3 Extended Power Uprate" (non-proprietary version in Reference 5), the current short-term drywell pressure response (drywell pressure versus time) was calculated using the M3CPT code which also provides the drywell pressurization rate. Please explain what other method was used for calculating the drywell pressurization rate at the MELLLA+ condition and how does the results compare with the M3CPT results.

[1] For the text of the redacted proprietary information in SRXB-C RAI-4, refer to Enclosure 3 of NRC letter to TVA, "Browns Ferry Nuclear Plants, Units 1, 2, and 3 - Request for Additional Information Regarding Maximum Extended Load Line Limit Plus License Amendment Request (EPID L-2018-LLA-0048)(ADAMS Accession No. ML18331A546)

Reference

5. GE Hitachi Nuclear Energy, NEDO-33860NP, Revision 1 "Safety Analysis Report for Browns Ferry Nuclear Plant Units 1, 2, and 3 Extended Power Uprate," dated October 2016 (ADAMS Accession No. ML16302A441).

TVA Response

Mass and energy release is obtained from the LAMB calculations and used as input to M3CPT to calculate the containment pressurization rate. There are no other methods used in calculating the pressurization rate.

SRXB-C RAI-5

Draft GDC 10, insofar as it requires that reactor containment be designed to sustain the initial effects of gross equipment failures, such as a large coolant boundary break, without loss of required integrity and, together with other engineered safety features as may be necessary, to retain functional capability for as long as the situation requires.

Draft GDC 41 and 52 in part requires a system to remove heat from the reactor containment shall be provided.

Section 4.2.6.1 of M+SAR, last sentence in sixth paragraph states:

The RHR [residual heat removal] pump flow used in the ATWS [anticipated transient without scram] NPSH [net positive suction head] analysis was increased by a factor of $1/\sqrt{0.97}$ (1.015) to account for the reduction in pump flow rate associated with a 3% reduction in pump total developed head.

Please clarify.

TVA Response

The factor of $1/\sqrt{0.97}$ (1.015) to account for the reduction in pump flow rate associated with a 3% reduction in pump total developed head is applied to be in conformance with Sections 6.3.6 and 6.6.2 of Reference 1. This same factor was used in Section 2.6.5.2 of Reference 2 and is unchanged with the proposed MELLLA+ operating domain expansion.

Section 6.3.6 of Reference 1 is as follows:

“6.3.6 Pump Flow Rate

The flow rate chosen for the NPSHa analysis should be greater than or equal to the flow rate assumed in the safety analyses that demonstrate adequate core and containment cooling. This ensures that the safety analysis and the NPSH analysis are consistent.

If the assumption that NPSHa equals NPSH_{reff} is used to determine the containment accident pressure employed, then the pump flow rate used in the core and containment cooling calculations should be equal to or less than the flow rate resulting from a 3-percent decrease in pump TDH.”

Section 6.6.2 of Reference 1 is as follows:

“6.6.2 Maximum Pump Flow Rate for the NPSHa Analysis

The maximum flow rate chosen for the NPSHa analysis should be greater than or equal to the flow rate assumed in the safety analyses that demonstrate adequate core and containment cooling. This ensures that the safety analysis and the NPSH analysis are consistent. If the NPSHa is assumed to equal the NPSH_{r3%} (the usual assumption for determining the amount of containment accident pressure used), then the flow rate used in the core and containment cooling analyses should also be equal to or greater than the flow rate resulting from a 3-percent decrease in pump TDH.”

References

1. SECY-11-0014, R. W. Borchardt (Executive Director for Operations NRC) to NRC Commissioners, Subject: “Use of Containment Accident Pressure in Analyzing Emergency Core Cooling System and Containment Heat Removal System Pump Performance in Postulated Accidents,” January 31, 2011 including Attachment 1, “The Use of Containment Accident Pressure in Reactor Safety Analysis”
2. GE Hitachi Nuclear Energy, “Safety Analysis Report for Browns Ferry Nuclear Plant Units 1, 2, and 3 Extended Power Uprate,” NEDC-33860P, Revision 1, October 2016

SRXB-C RAI-6

The response to this RAI is provided in a separate enclosure.

ENCLOSURE 6

Affidavit – GE-Hitachi Nuclear Energy Americas LLC

GE-Hitachi Nuclear Energy Americas LLC

AFFIDAVIT

I, **Lisa K. Schichlein**, state as follows:

- (1) I am a Senior Project Manager, NPP/Services Licensing, Regulatory Affairs, GE-Hitachi Nuclear Energy Americas LLC (“GEH”) and have been delegated the function of reviewing the information described in paragraph (2) which is sought to be withheld and have been authorized to apply for its withholding.
- (2) The information sought to be withheld is contained in Enclosure 1 of GEH letter, DOC-0007-4283-138, “GEH Responses to MELLLLA+ RAIs SRXB-RAI 1, 2, 3, and 4, SNPB-RAI-1a, and SRXB-C-RAI-6,” dated December 12, 2018. The GEH proprietary information in Enclosure 1, which is entitled “Responses to SRXB-RAI 1, 2, 3, and 4, SNPB-RAI-1a, and SRXB-C-RAI-6 in Support of BFN MELLLLA+ LAR,” is identified by a dotted underline inside double square brackets. [[This sentence is an example.^{3}]] Figures and large objects containing GEH proprietary information are identified with double square brackets before and after the object. In each case, the superscript notation ^{3} refers to Paragraph (3) of this affidavit, which provides the basis for the proprietary determination.
- (3) In making this application for withholding of proprietary information of which it is the owner or licensee, GEH relies upon the exemption from disclosure set forth in the *Freedom of Information Act* (“FOIA”), 5 U.S.C. Sec. 552(b)(4), and the *Trade Secrets Act*, 18 U.S.C. Sec. 1905, and NRC regulations 10 CFR 9.17(a)(4), and 2.390(a)(4) for trade secrets (Exemption 4). The material for which exemption from disclosure is here sought also qualifies under the narrower definition of trade secret, within the meanings assigned to those terms for purposes of FOIA Exemption 4 in, respectively, Critical Mass Energy Project v. Nuclear Regulatory Commission, 975 F.2d 871 (D.C. Cir. 1992), and Public Citizen Health Research Group v. FDA, 704 F.2d 1280 (D.C. Cir. 1983).
- (4) The information sought to be withheld is considered to be proprietary for the reasons set forth in paragraphs (4)a. and (4)b. Some examples of categories of information that fit into the definition of proprietary information are:
 - a. Information that discloses a process, method, or apparatus, including supporting data and analyses, where prevention of its use by GEH's competitors without license from GEH constitutes a competitive economic advantage over other companies;
 - b. Information that, if used by a competitor, would reduce their expenditure of resources or improve their competitive position in the design, manufacture, shipment, installation, assurance of quality, or licensing of a similar product;
 - c. Information that reveals aspects of past, present, or future GEH customer-funded development plans and programs, resulting in potential products to GEH;
 - d. Information that discloses trade secret or potentially patentable subject matter for which it may be desirable to obtain patent protection.

GE-Hitachi Nuclear Energy Americas LLC

- (5) To address 10 CFR 2.390(b)(4), the information sought to be withheld is being submitted to NRC in confidence. The information is of a sort customarily held in confidence by GEH, and is in fact so held. The information sought to be withheld has, to the best of my knowledge and belief, consistently been held in confidence by GEH, not been disclosed publicly, and not been made available in public sources. All disclosures to third parties, including any required transmittals to the NRC, have been made, or must be made, pursuant to regulatory provisions or proprietary or confidentiality agreements that provide for maintaining the information in confidence. The initial designation of this information as proprietary information, and the subsequent steps taken to prevent its unauthorized disclosure, are as set forth in the following paragraphs (6) and (7).
- (6) Initial approval of proprietary treatment of a document is made by the manager of the originating component, who is the person most likely to be acquainted with the value and sensitivity of the information in relation to industry knowledge, or who is the person most likely to be subject to the terms under which it was licensed to GEH.
- (7) The procedure for approval of external release of such a document typically requires review by the staff manager, project manager, principal scientist, or other equivalent authority for technical content, competitive effect, and determination of the accuracy of the proprietary designation. Disclosures outside GEH are limited to regulatory bodies, customers, and potential customers, and their agents, suppliers, and licensees, and others with a legitimate need for the information, and then only in accordance with appropriate regulatory provisions or proprietary or confidentiality agreements.
- (8) The information identified in paragraph (2), above, is classified as proprietary because it contains detailed results and conclusions regarding supporting evaluations of the safety-significant changes necessary to demonstrate the regulatory acceptability of the Maximum Extended Load Line Limit Analysis Plus analysis for a GEH Boiling Water Reactor (“BWR”). The analysis utilized analytical models and methods, including computer codes, which GEH has developed, obtained NRC approval of, and applied to perform evaluations of Maximum Extended Load Line Limit Analysis Plus for a GEH BWR.

The development of the evaluation processes along with the interpretation and application of the analytical results is derived from the extensive experience and information databases that constitute a major GEH asset.

- (9) Public disclosure of the information sought to be withheld is likely to cause substantial harm to GEH's competitive position and foreclose or reduce the availability of profit-making opportunities. The information is part of GEH's comprehensive BWR safety and technology base, and its commercial value extends beyond the original development cost. The value of the technology base goes beyond the extensive physical database and analytical methodology and includes development of the expertise to determine and apply the appropriate evaluation process. In addition, the technology base includes the value derived from providing analyses done with NRC-approved methods.

GE-Hitachi Nuclear Energy Americas LLC

The research, development, engineering, analytical and NRC review costs comprise a substantial investment of time and money by GEH. The precise value of the expertise to devise an evaluation process and apply the correct analytical methodology is difficult to quantify, but it clearly is substantial. GEH's competitive advantage will be lost if its competitors are able to use the results of the GEH experience to normalize or verify their own process or if they are able to claim an equivalent understanding by demonstrating that they can arrive at the same or similar conclusions.

The value of this information to GEH would be lost if the information were disclosed to the public. Making such information available to competitors without their having been required to undertake a similar expenditure of resources would unfairly provide competitors with a windfall, and deprive GEH of the opportunity to exercise its competitive advantage to seek an adequate return on its large investment in developing and obtaining these very valuable analytical tools.

I declare under penalty of perjury that the foregoing is true and correct.

Executed on this 12th day of December 2018.



Lisa K. Schichlein
Senior Project Manager, NPP/Services Licensing
Regulatory Affairs
GE-Hitachi Nuclear Energy Americas LLC
3901 Castle Hayne Road
Wilmington, NC 28401
Lisa.Schichlein@ge.com

ENCLOSURE 7

Affidavit – Framatome Inc.

A F F I D A V I T

STATE OF WASHINGTON)
) ss.
COUNTY OF BENTON)

1. My name is Alan B. Meginnis. I am Manager, Product Licensing, for Framatome Inc. and as such I am authorized to execute this Affidavit.

2. I am familiar with the criteria applied by Framatome to determine whether certain Framatome information is proprietary. I am familiar with the policies established by Framatome to ensure the proper application of these criteria.

3. I am familiar with the Framatome information contained in the report ANP-3747P, Revision 0, "Framatome RAI Responses for Browns Ferry MELLLA+," dated December 2018 and referred to herein as "Document." Information contained in this Document has been classified by Framatome as proprietary in accordance with the policies established by Framatome for the control and protection of proprietary and confidential information.

4. This Document contains information of a proprietary and confidential nature and is of the type customarily held in confidence by Framatome and not made available to the public. Based on my experience, I am aware that other companies regard information of the kind contained in this Document as proprietary and confidential.

5. This Document has been made available to the U.S. Nuclear Regulatory Commission in confidence with the request that the information contained in this Document be withheld from public disclosure. The request for withholding of proprietary information is made in accordance with 10 CFR 2.390. The information for which withholding from disclosure is

requested qualifies under 10 CFR 2.390(a)(4) "Trade secrets and commercial or financial information."

6. The following criteria are customarily applied by Framatome to determine whether information should be classified as proprietary:

- (a) The information reveals details of Framatome's research and development plans and programs or their results.
- (b) Use of the information by a competitor would permit the competitor to significantly reduce its expenditures, in time or resources, to design, produce, or market a similar product or service.
- (c) The information includes test data or analytical techniques concerning a process, methodology, or component, the application of which results in a competitive advantage for Framatome.
- (d) The information reveals certain distinguishing aspects of a process, methodology, or component, the exclusive use of which provides a competitive advantage for Framatome in product optimization or marketability.
- (e) The information is vital to a competitive advantage held by Framatome, would be helpful to competitors to Framatome, and would likely cause substantial harm to the competitive position of Framatome.

The information in the Document is considered proprietary for the reasons set forth in paragraphs 6(b), 6(d) and 6(e) above.

7. In accordance with Framatome's policies governing the protection and control of information, proprietary information contained in this Document have been made available, on a limited basis, to others outside Framatome only as required and under suitable agreement providing for nondisclosure and limited use of the information.

8. Framatome policy requires that proprietary information be kept in a secured file or area and distributed on a need-to-know basis.

9. The foregoing statements are true and correct to the best of my knowledge, information, and belief.

Alan B. Meg

SUBSCRIBED before me this 13th
day of December, 2018.

Susan K McCoy

Susan K. McCoy
NOTARY PUBLIC, STATE OF WASHINGTON
MY COMMISSION EXPIRES: 1/14/2020

SUSAN K MCCOY
NOTARY PUBLIC - WASHINGTON
MY COMMISSION EXPIRES 01-14-2020