

INDIAN POINT UNIT No. 2

UFSAR FIGURE 3.2-1
TYPICAL
POWER PEAKING FACTOR
VERSUS AXIAL OFFSET

MIC. No. 1999MC3583

REV. No. 17B

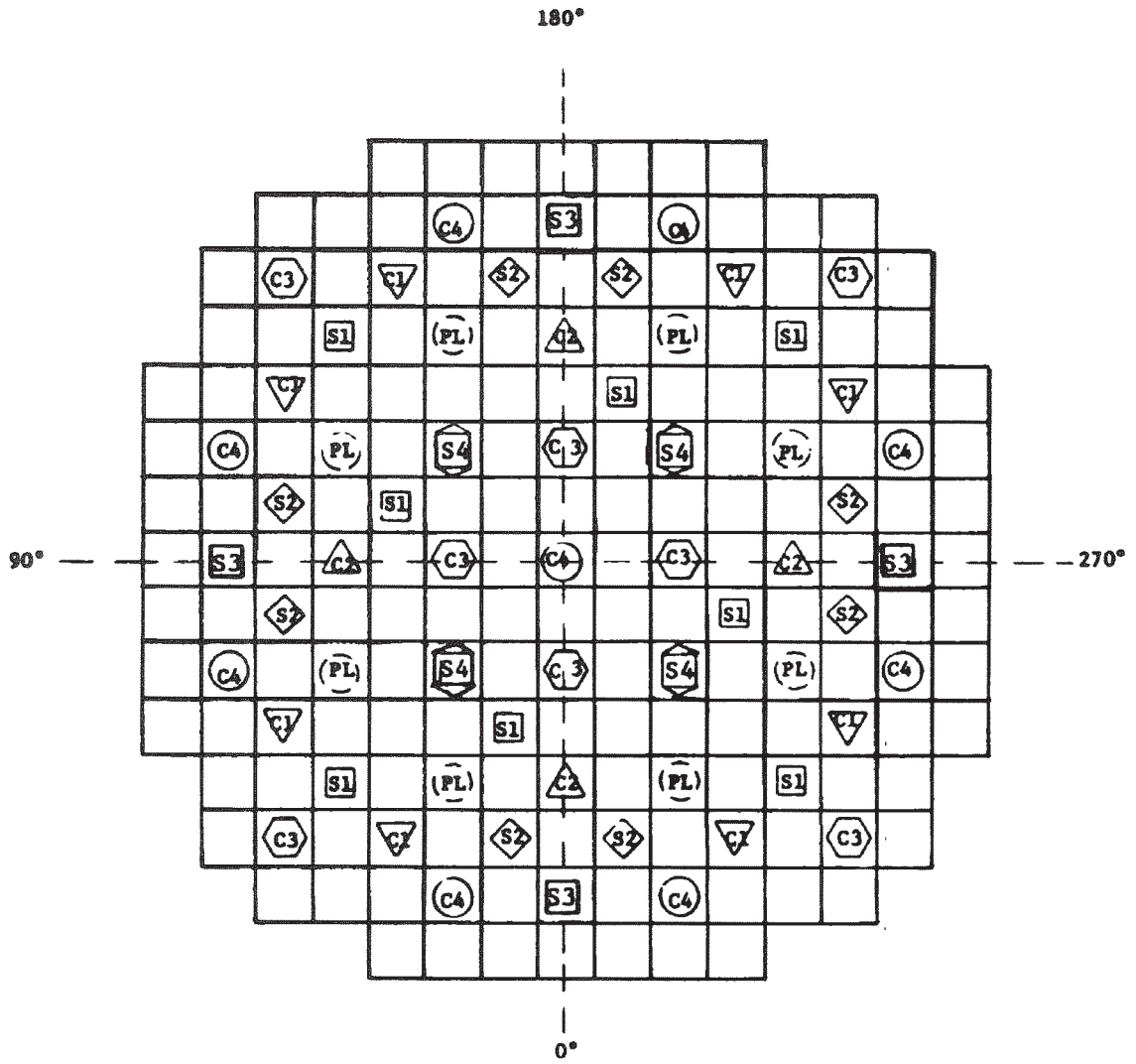

| <u>GROUP</u> | <u>SYMBOL</u> | <u>NUMBER OF ROD CLUSTERS</u> |
|---------------|---------------|-------------------------------|
| S1 | □ | 8 |
| S2 | ◇ | 8 |
| S3 | ◻ | 4 |
| S4 | ◻ | 4 |
| C1 | ▽ | 8 |
| C2 | △ | 4 |
| C3 | ○ | 8 |
| C4 | ○ | 9 |
| PL | ○ | 8 |
| (Part Length) | | <u>61</u> |

INDIAN POINT UNIT No. 2

UFSAR FIGURE 3.2-2

ROD CLUSTER GROUPS -
CYCLE 1

MIC. No. 1999MC3584

REV. No. 17A

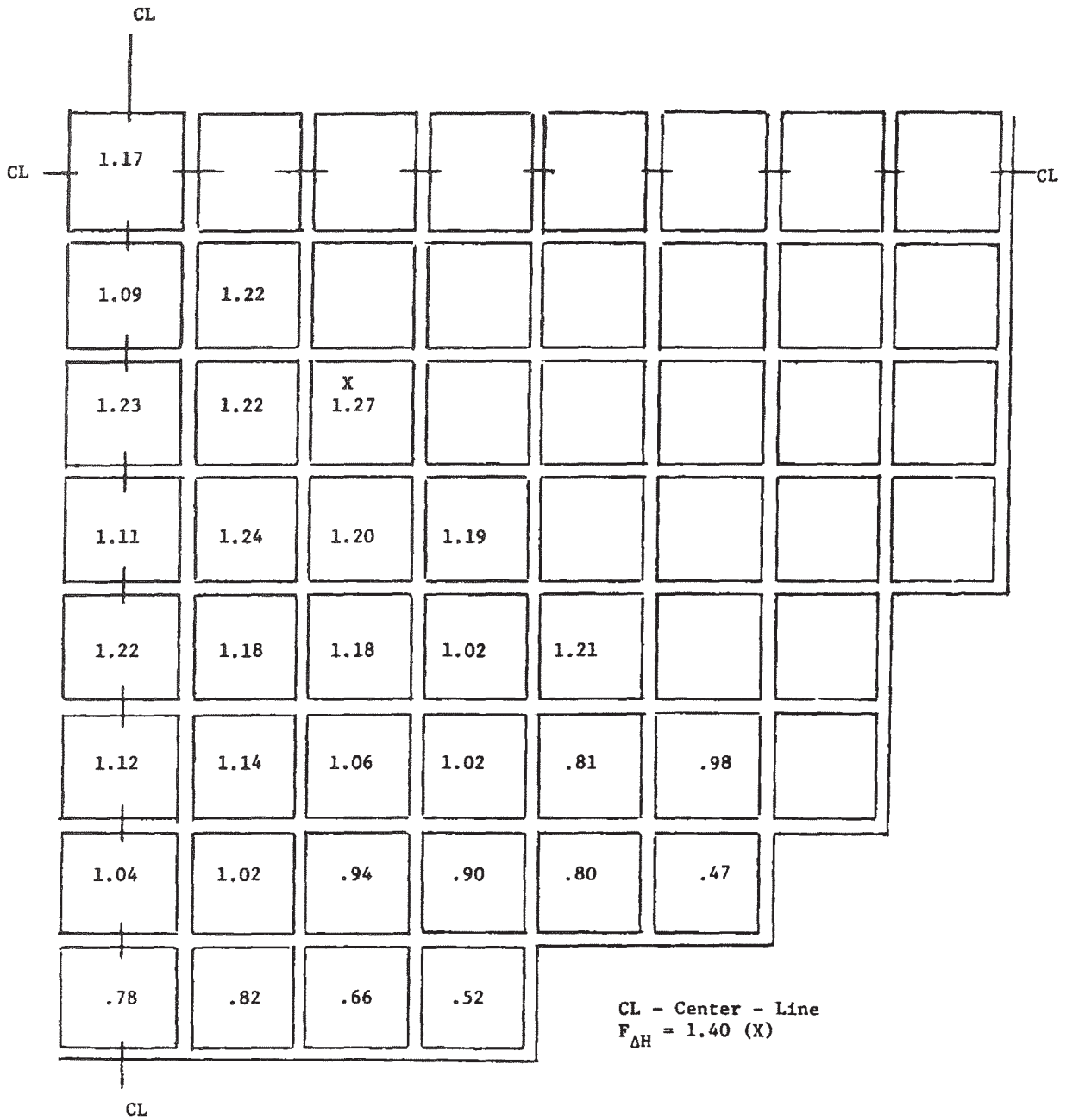

INDIAN POINT UNIT No. 2

UFSAR FIGURE 3.2-3
 ASSEMBLY AVERAGE POWER & BURNUP,
 CYCLE 1 CALCULATIONS, BOL,
 UNRODDED CORE

MIC. No. 1999MC3585

REV. No. 17A

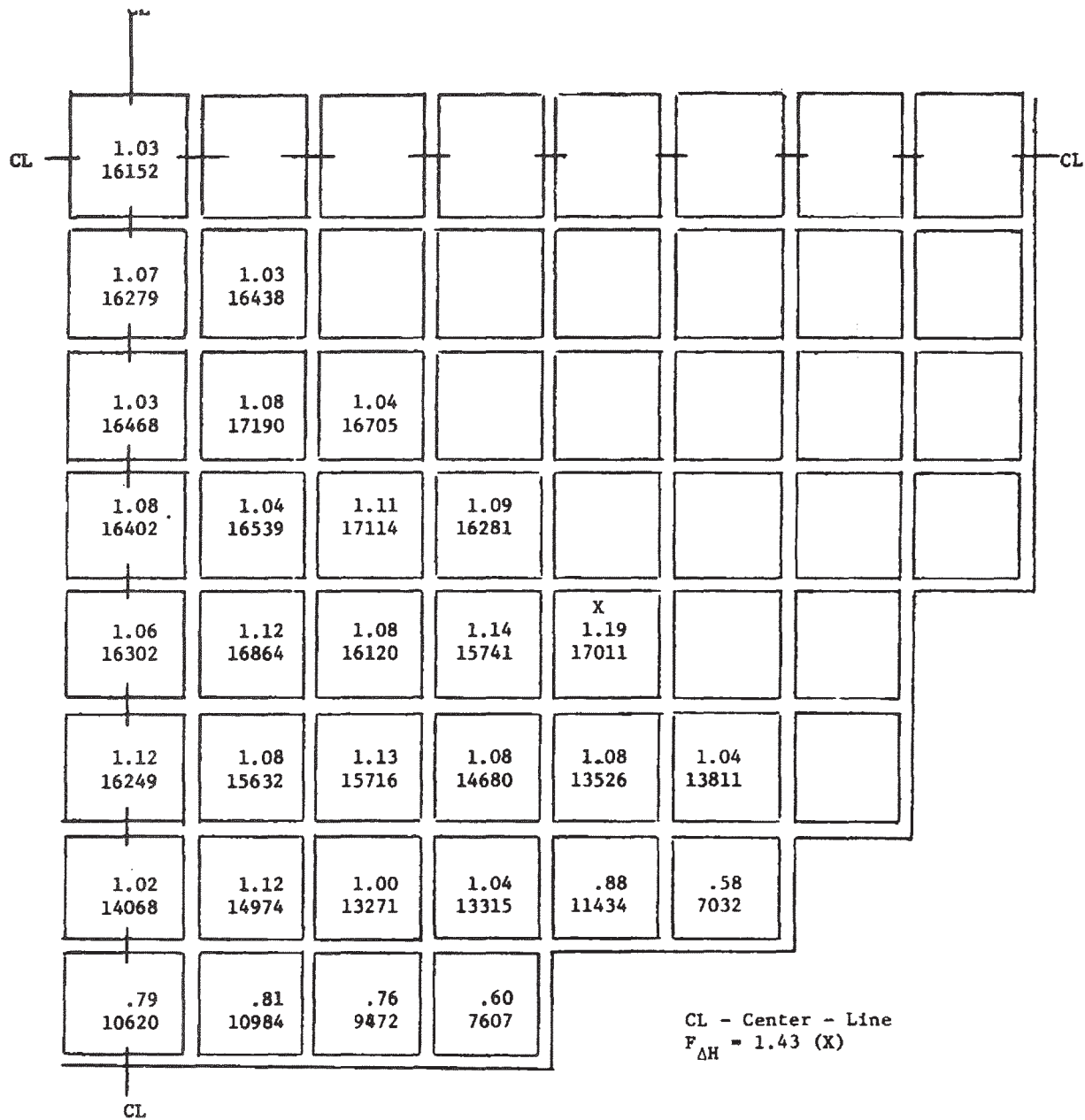

INDIAN POINT UNIT No. 2

UFSAR FIGURE 3.2-4

ASSEMBLY AVERAGE POWER & BURNUP,
 CYCLE 1 CALCULATIONS, EOL,
 UNRODDED CORE

MIC. No. 1999MC3586

REV. No. 17A

| | | | | | | | |
|-------|-------|---|-------|-------|-------|-------|-------|
| 0.671 | 1.090 | 1.439 | 1.343 | 1.362 | 1.113 | 0.882 | 0.603 |
| 1.090 | 1.340 | 1.447 | 1.487 | 1.309 | 1.088 | 0.777 | 0.579 |
| 1.439 | 1.447 | 1.544 | 1.437 | 1.308 | 0.944 | 0.424 | 0.401 |
| | | ΔH N  | | | | | |
| 1.343 | 1.487 | 1.437 | 1.407 | 1.160 | 1.010 | 0.701 | 0.374 |
| 1.362 | 1.309 | 1.308 | 1.160 | 1.367 | 0.948 | 0.812 | |
| 1.113 | 1.088 | 0.944 | 1.010 | 0.948 | 1.109 | 0.535 | |
| 0.882 | 0.777 | 0.424 | 0.701 | 0.812 | 0.535 | | |
| 0.603 | 0.579 | 0.401 | 0.374 | | | | |

INDIAN POINT UNIT No. 2

UFSAR FIGURE 3.2-5

ASSEMBLY AVERAGE POWER DISTRIBUTION
CYCLE 1 CALCULATIONS, BOL,
GROUP C4 INSERTED

MIC. No. 1999MC3587

REV. No. 17A

| | | | | | | | |
|---------------------|------------------------------------|-------|-------|-------|-------|-------|-------|
| X X 1.402 X X | ← ^N F ΔH 1.290 | 1.349 | 1.130 | 1.169 | 1.157 | 1.171 | 0.917 |
| 1.290 | 1.395 | 1.286 | 1.161 | 0.989 | 1.110 | 1.149 | 0.967 |
| 1.349 | 1.286 | 1.227 | 0.962 | 0.568 | 0.929 | 1.045 | 0.799 |
| 1.130 | 1.161 | 0.962 | 0.940 | 0.830 | 0.999 | 1.000 | 0.633 |
| 1.169 | 0.989 | 0.568 | 0.830 | 1.189 | 0.954 | 0.938 | |
| 1.157 | 1.110 | 0.929 | 0.999 | 0.954 | 1.159 | 0.584 | |
| 1.171 | 1.149 | 1.045 | 1.000 | 0.938 | 0.584 | | |
| 0.917 | 0.867 | 0.799 | 0.633 | | | | |

INDIAN POINT UNIT No. 2

UFSAR FIGURE 3.2-6

ASSEMBLY AVERAGE POWER DISTRIBUTION
CYCLE 1 CALCULATIONS, BOL,
PART-LENGTH RODS IN

MIC. No. 1999MC3588

REV. No. 17A

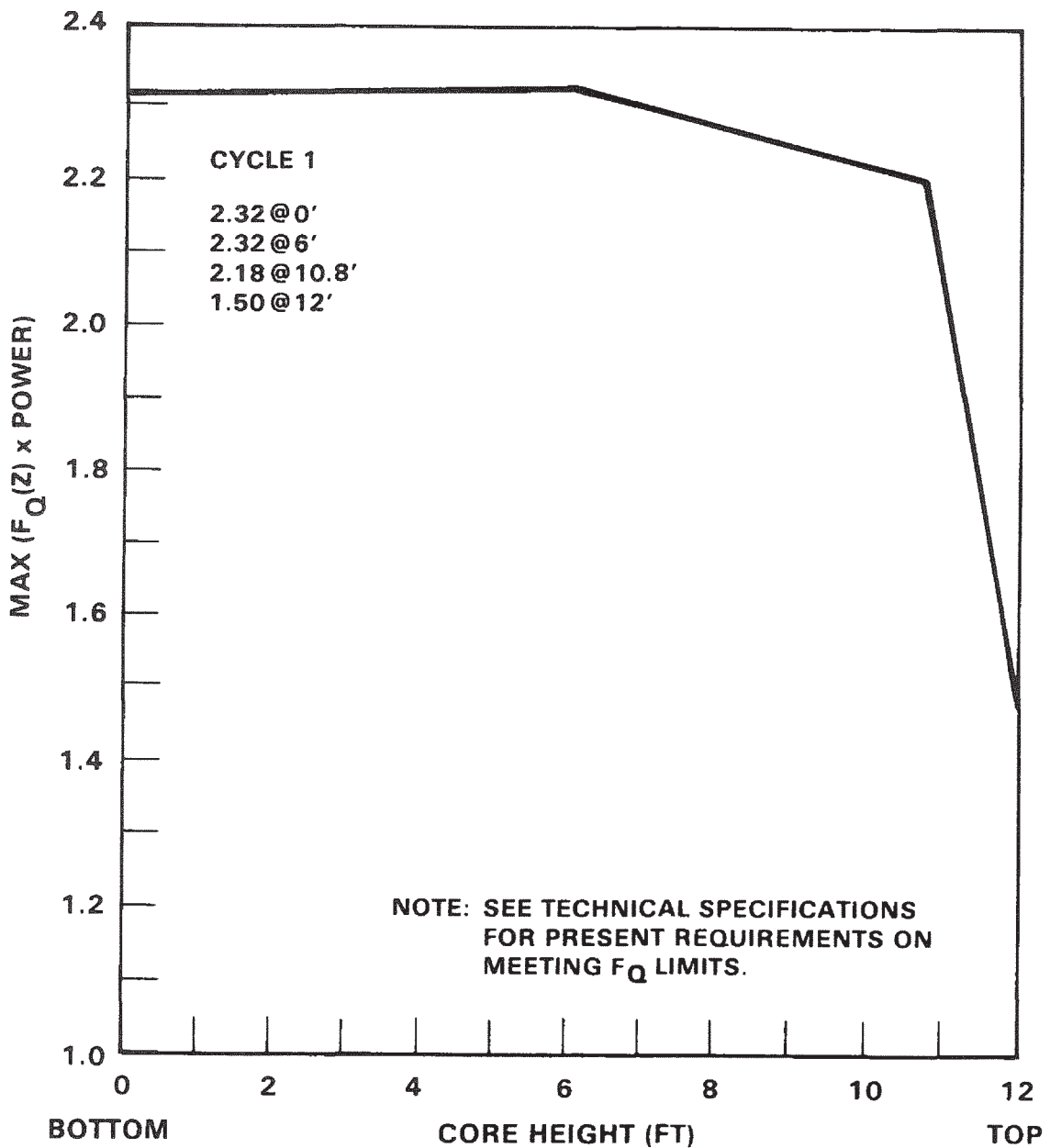

INDIAN POINT UNIT No. 2

UFSAR FIGURE 3.2-7

CYCLE 1 MAXIMUM F_Q x POWER VERSUS AXIAL HEIGHT DURING NORMAL OPERATIONS

MIC. No. 1999MC3589

REV. No. 17A

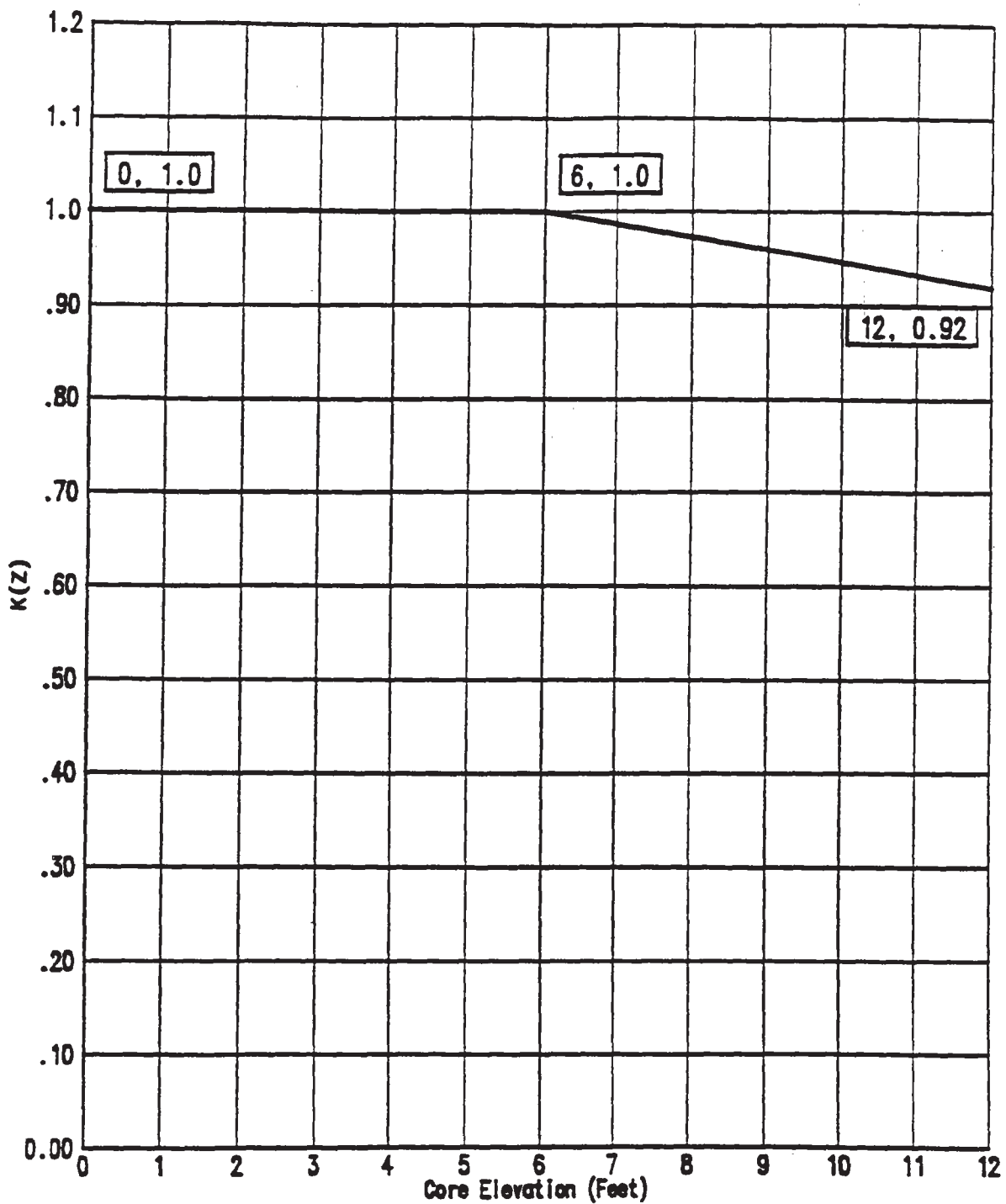

INDIAN POINT UNIT No. 2

UFSAR FIGURE 3.2-7A

NORMALIZED $K(z) - F_q$ VERSUS
AXIAL HEIGHT FOR CYCLE 16

MIC. No. 1999MC3590

REV. No. 17B

| | | | | | | | | | | | | | | |
|----|---------|----|----|----|----|----|--------|----|----|----|----|----|---------|------------|
| 15 | 14 | 13 | 12 | 11 | 10 | 9 | 8 | 7 | 6 | 5 | 4 | 3 | 2 | 1 |
| | | | | | 9 | | S 7 | | 9 | | | | | |
| | | 8 | | 12 | | 16 | | 16 | | 12 | | 8 | | |
| | 8 | | 20 | | 12 | | 16 | | 12 | | 20 | | 8 | |
| | | 20 | | 20 | | 16 | | 16 | | 20 | | 20 | | |
| | 12 | | 20 | | 16 | | 16 | | 16 | | 20 | | 12 | |
| 9 | | 12 | | 16 | | 20 | | 20 | | 16 | | 12 | | 9 |
| | P 16 | | 16 | | 20 | | 16 | | 20 | | 16 | | P 16 | |
| 7 | | 16 | | 16 | | 16 | | 16 | | 16 | | 16 | | 7 |
| | P 16 | | 16 | | 20 | | 16 | | 20 | | 16 | | P 16 | |
| 9 | | 12 | | 16 | | 20 | | 20 | | 16 | | 12 | | 9 |
| | 12 | | 20 | | 16 | | 16 | | 16 | | 20 | | 12 | |
| | | 20 | | 20 | | 16 | | 16 | | 20 | | 20 | | |
| | 8 | | 20 | | 12 | | 16 | | 12 | | 20 | | 8 | |
| | | 8 | | 12 | | 16 | | 16 | | 12 | | 8 | | |
| | | | | | 9 | | S 7 | | 9 | | | | | |
| | | | | | | | | | | | | | | TOTAL 1412 |

P - PRIMARY/SECONDARY SOURCE COMBINATION
S - SECONDARY SOURCE;

INDIAN POINT UNIT No. 2

UFSAR FIGURE 3.2-8

BURNABLE POISON & SOURCE ASSEMBLY
LOCATIONS - CYCLE 1

MIC. No. 1999MC3591

REV. No. 17A

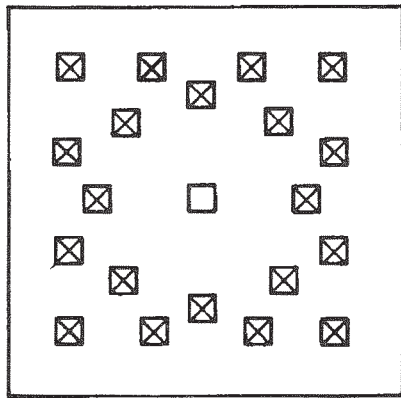

20 BP's

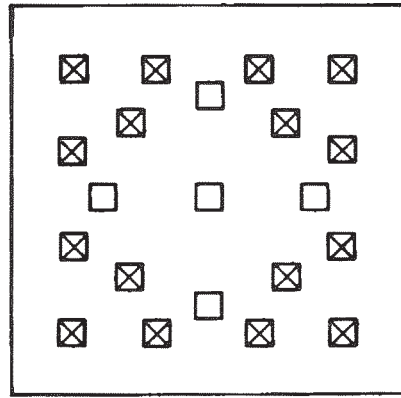

16 BP'2

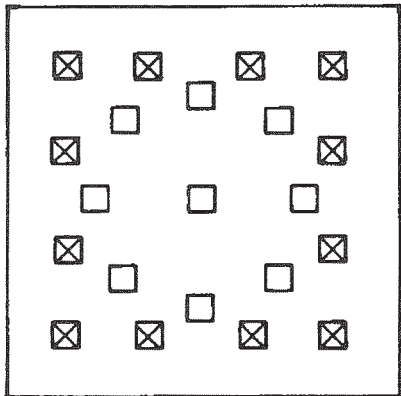

12 BP's

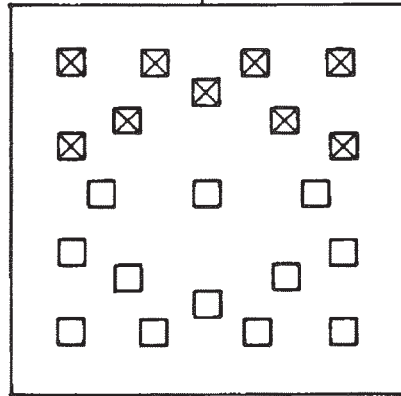

9 BP'2

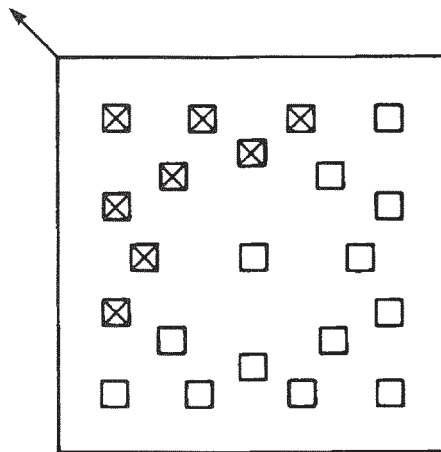

8 BP's

INDIAN POINT UNIT No. 2

UFSAR FIGURE 3.2-9

BURNABLE POISON ROD LOCATIONS
CYCLE 1

MIC. No. 1999MC3592

REV. No. 17A

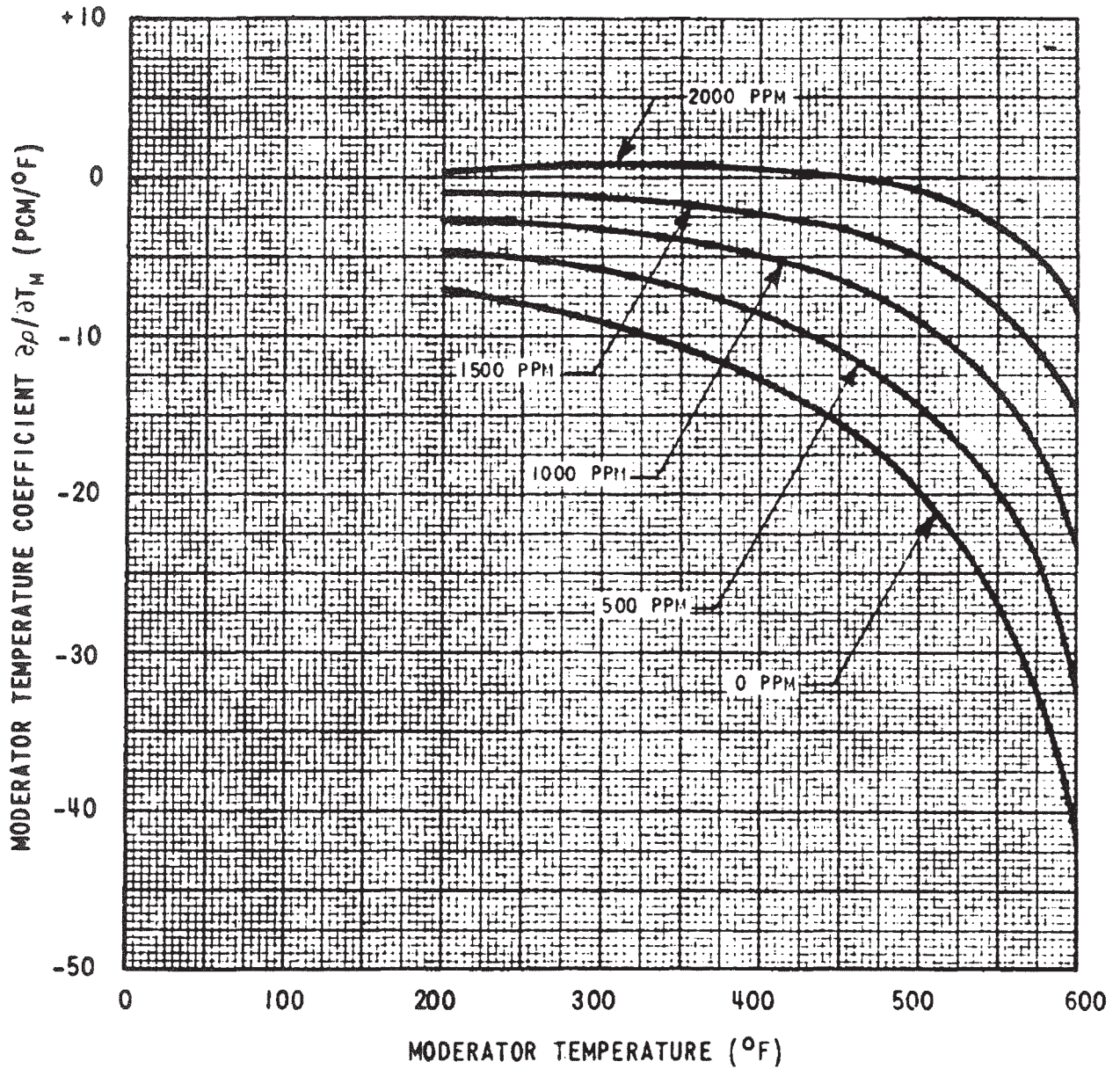

INDIAN POINT UNIT No. 2

UFSAR FIGURE 3.2-10

MODERATOR TEMPERATURE COEFFICIENT vs
MODERATOR TEMPERATURE - EOL, CYCLE 1

MIC. No. 1999MC3593

REV. No. 17A

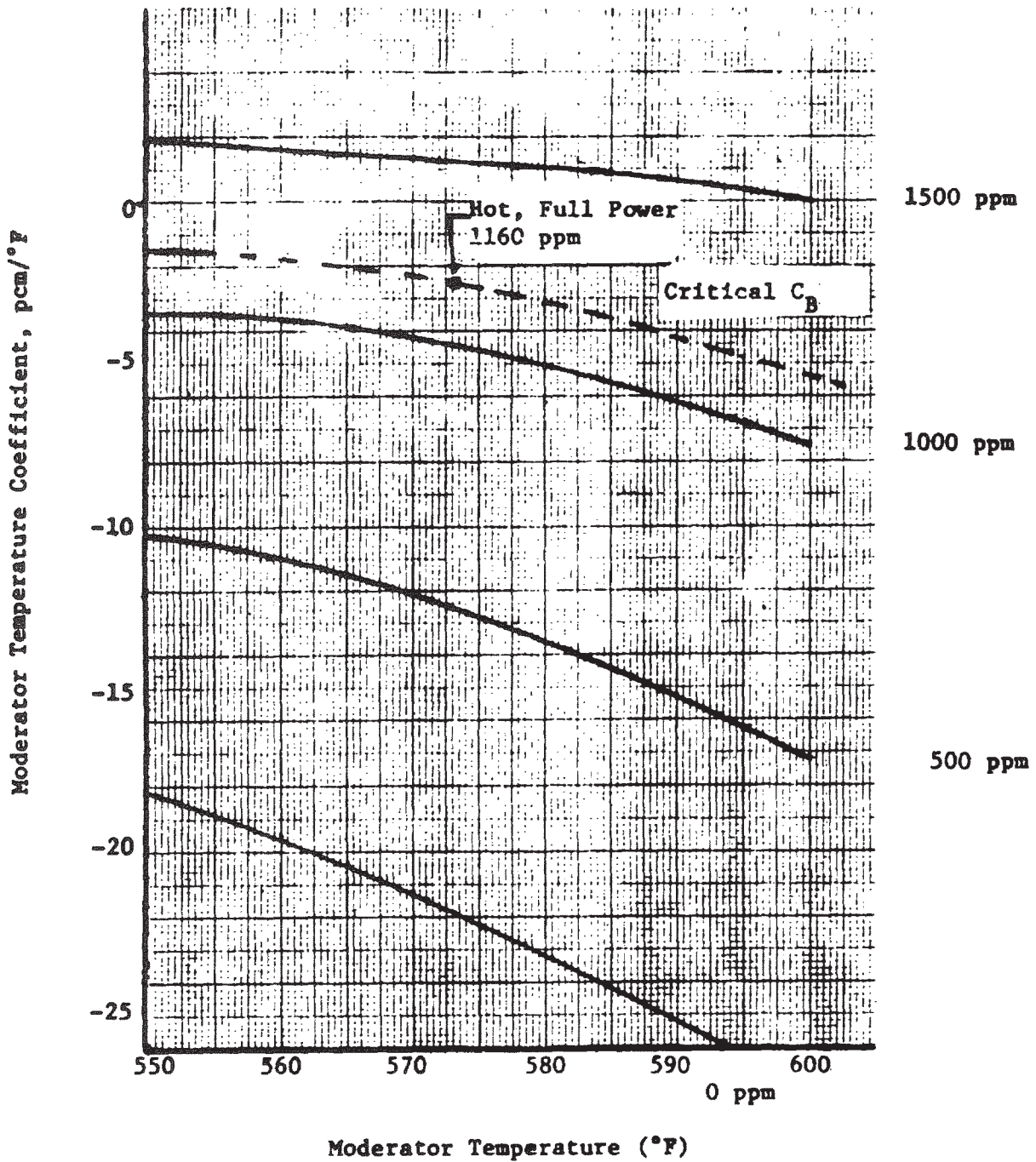

INDIAN POINT UNIT No. 2

UFSAR FIGURE 3.2-11

MODERATOR TEMPERATURE COEFFICIENT vs
MODERATOR TEMPERATURE - BOL, CYCLE 1
FULL POWER

MIC. No. 1999MC3594

REV. No. 17A

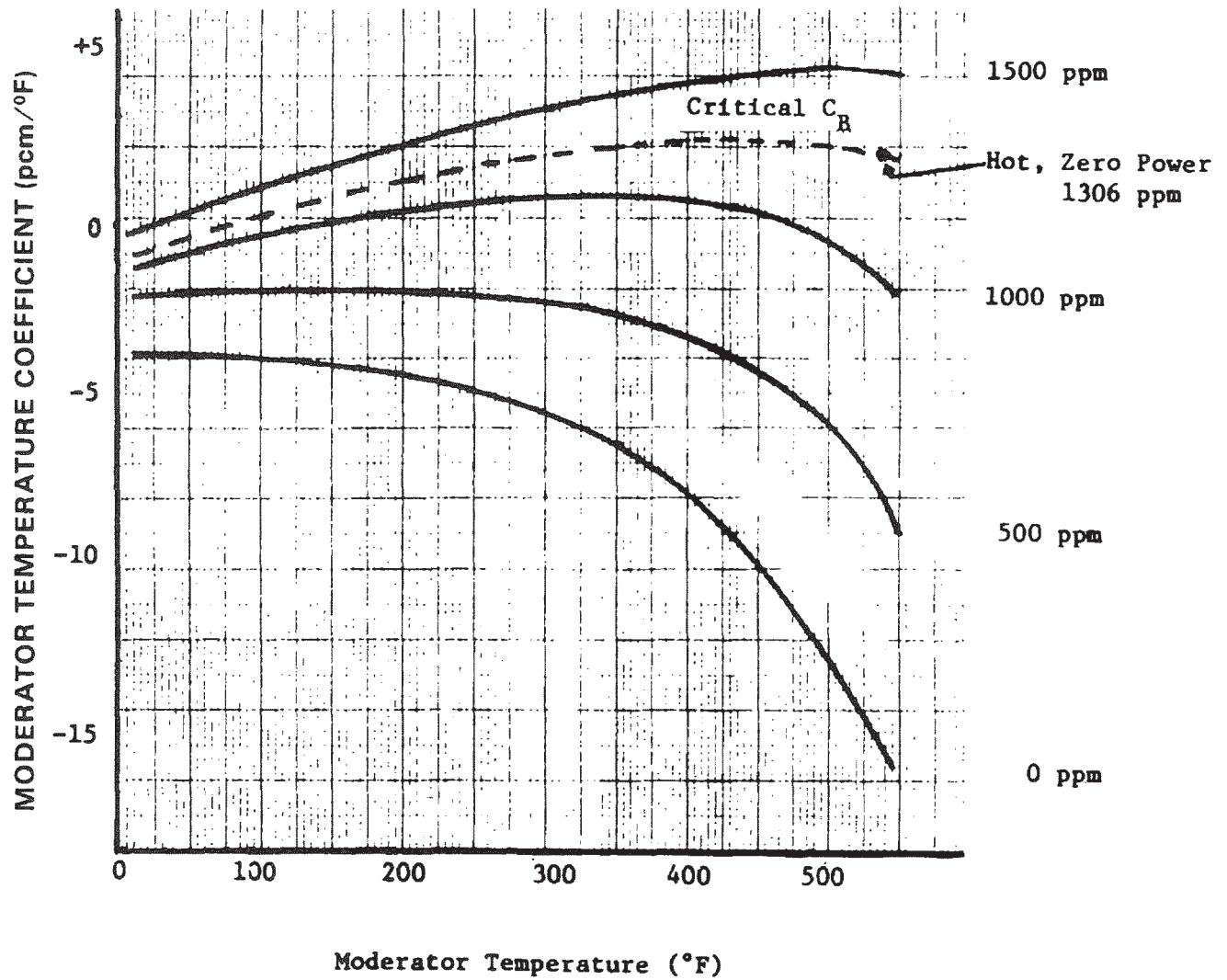

INDIAN POINT UNIT No. 2

UFSAR FIGURE 3.2-12

MODERATOR TEMPERATURE COEFFICIENT vs
MODERATOR TEMPERATURE - BOL, CYCLE 1
ZERO POWER

MIC. No. 1999MC3595

REV. No. 17A

DOPPLER COEFFICIENT
vs
EFFECTIVE FUEL TEMPERATURE

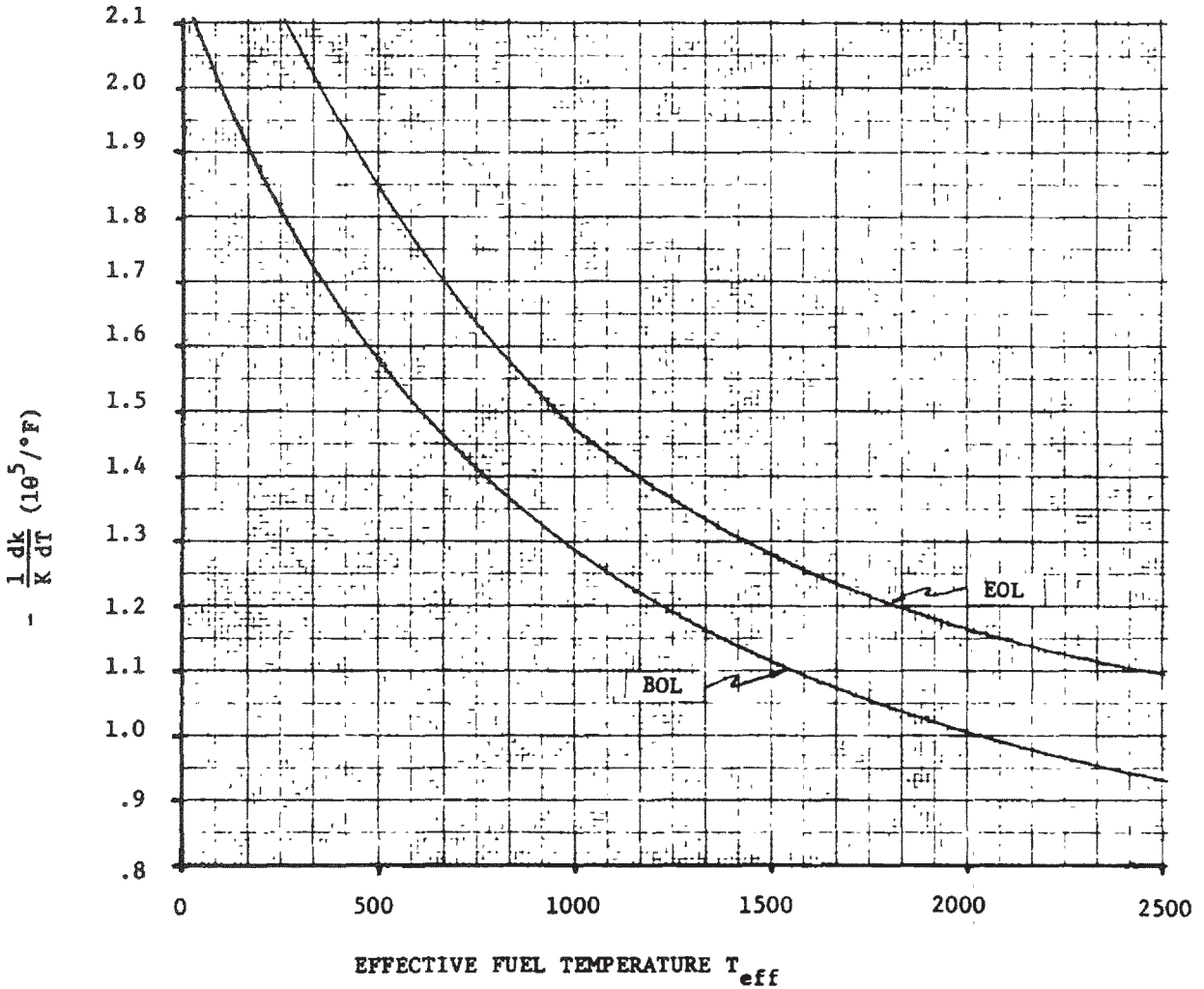

INDIAN POINT UNIT No. 2

UFSAR FIGURE 3.2-13

DOPPLER COEFFICIENT vs EFFECTIVE
FUEL TEMPERATURE - CYCLE 1

MIC. No. 1999MC3596

REV. No. 17A

POWER COEFFICIENT VS PERCENT POWER
 WITH $T_{MOD} = 572. \text{ } ^\circ\text{F}$
 $E = 2.7 \text{ W/O}$
 $BOL = 2100 \text{ ppm}$

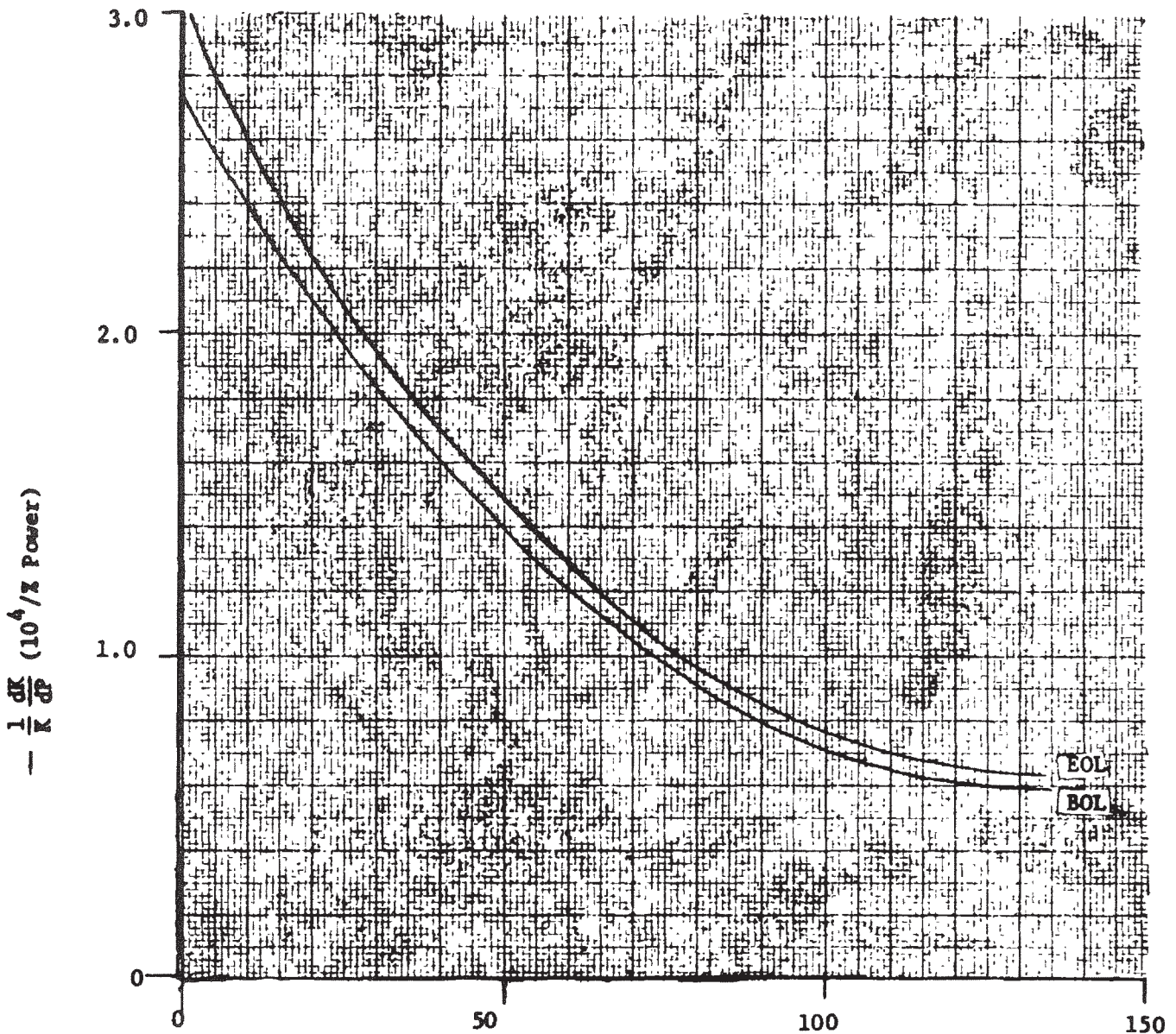

PERCENT OF FULL POWER, 2758 MWT

INDIAN POINT UNIT No. 2

UFSAR FIGURE 3.2-14

POWER COEFFICIENT vs PERCENT POWER
 CYCLE 1

MIC. No. 1999MC3597

REV. No. 17A

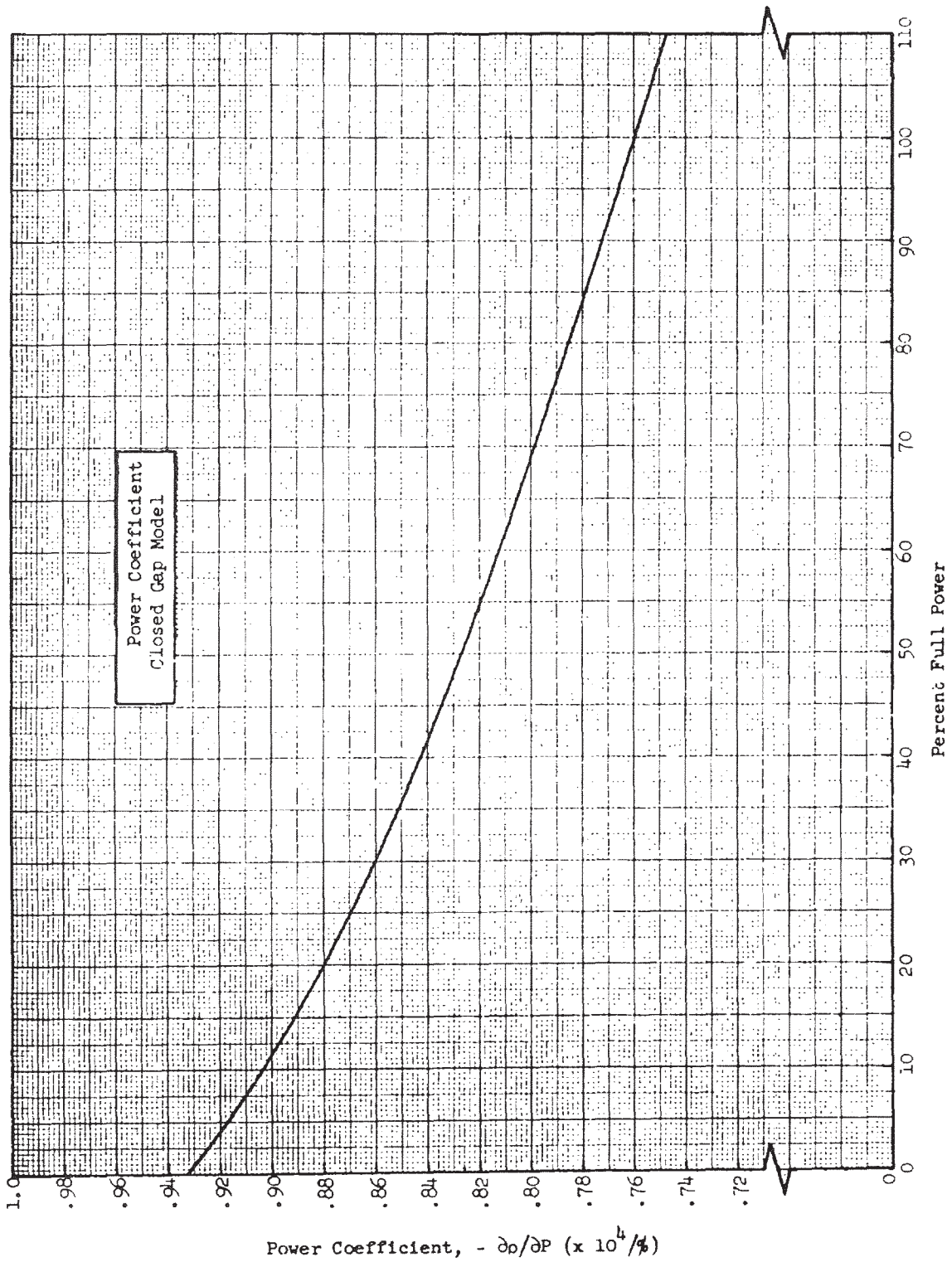

INDIAN POINT UNIT No. 2

UFSAR FIGURE 3.2-15

POWER COEFFICIENT - CLOSED GAP MODEL

MIC. No. 1999MC3598

REV. No. 17A

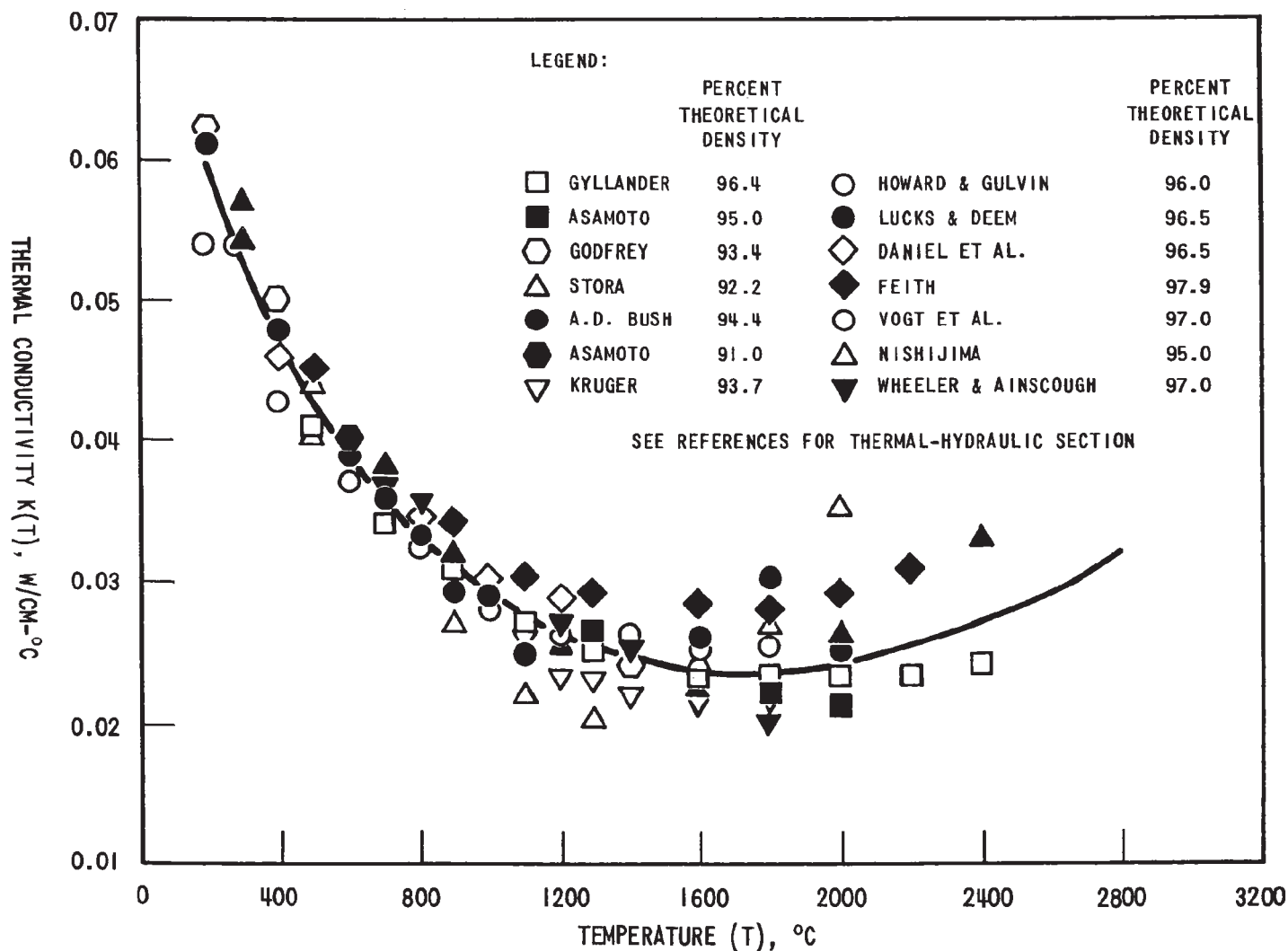

INDIAN POINT UNIT No. 2

UFSAR FIGURE 3.2-38
TYPICAL
THERMAL CONDUCTIVITY
OF UO₂

MIC. No. 1999MC3643 | REV. No. 17B

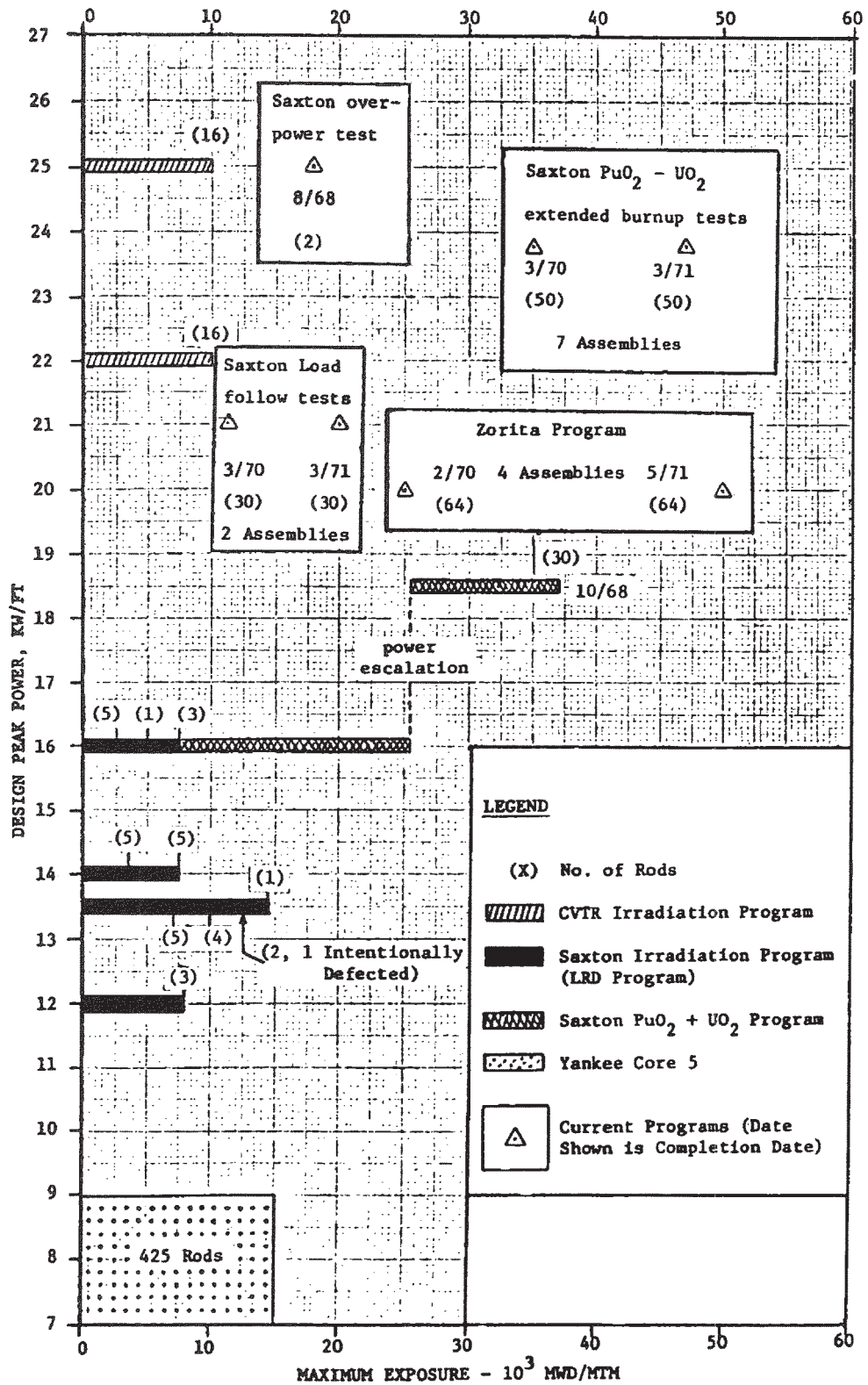

INDIAN POINT UNIT No. 2

UFSAR FIGURE 3.2-39

HIGH POWER FUEL ROD
EXPERIMENTAL PROGRAM

MIC. No. 1999MC3644

REV. No. 17A

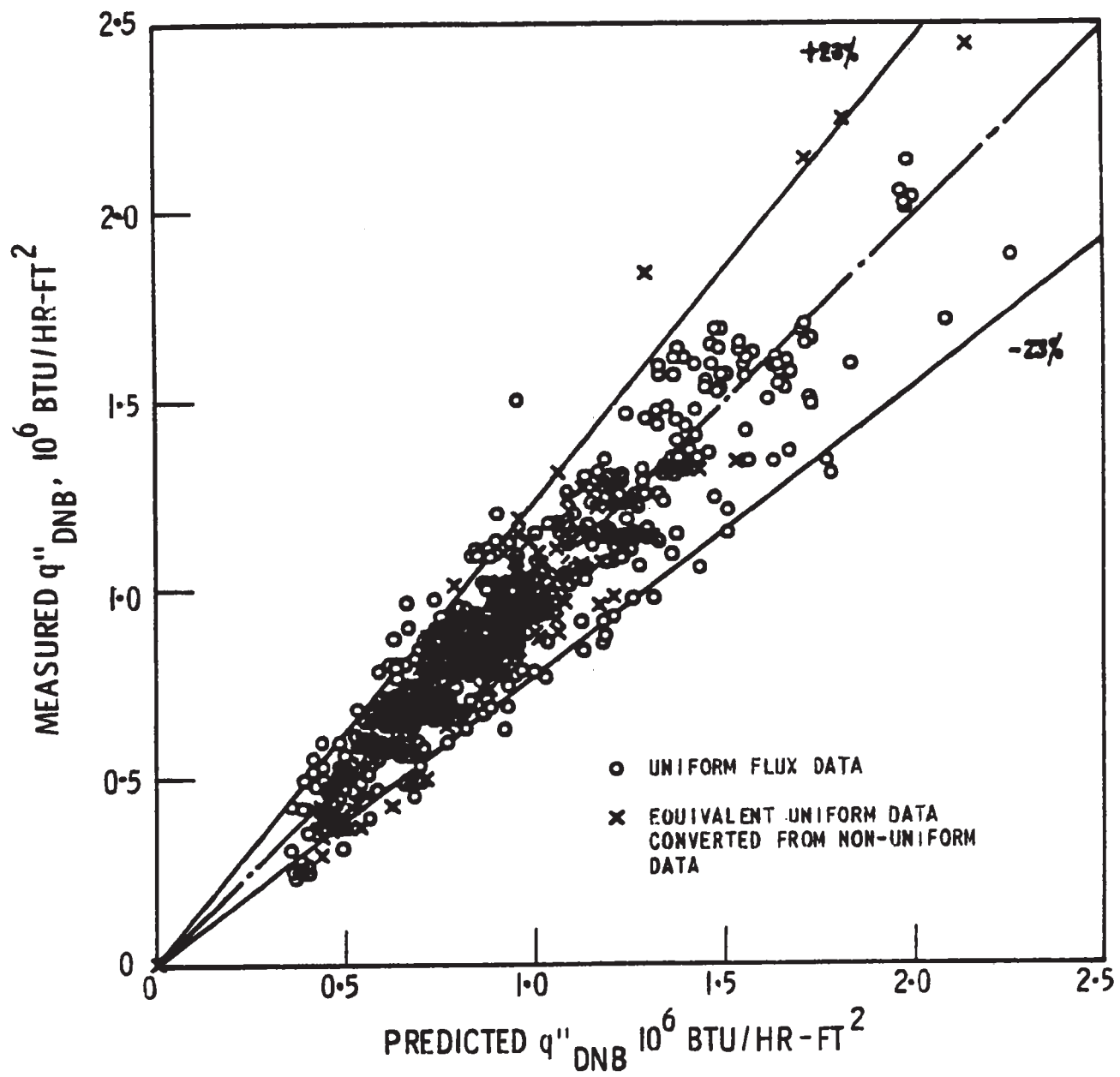

| | |
|---|--------------|
| INDIAN POINT UNIT No. 2 | |
| UFSAR FIGURE 3.2-40 TYPICAL | |
| COMPARISON OF W-3 PREDICTION AND UNIFORM FLUX DATA | |
| MIC. No. 1999MC3645 | REV. No. 17B |

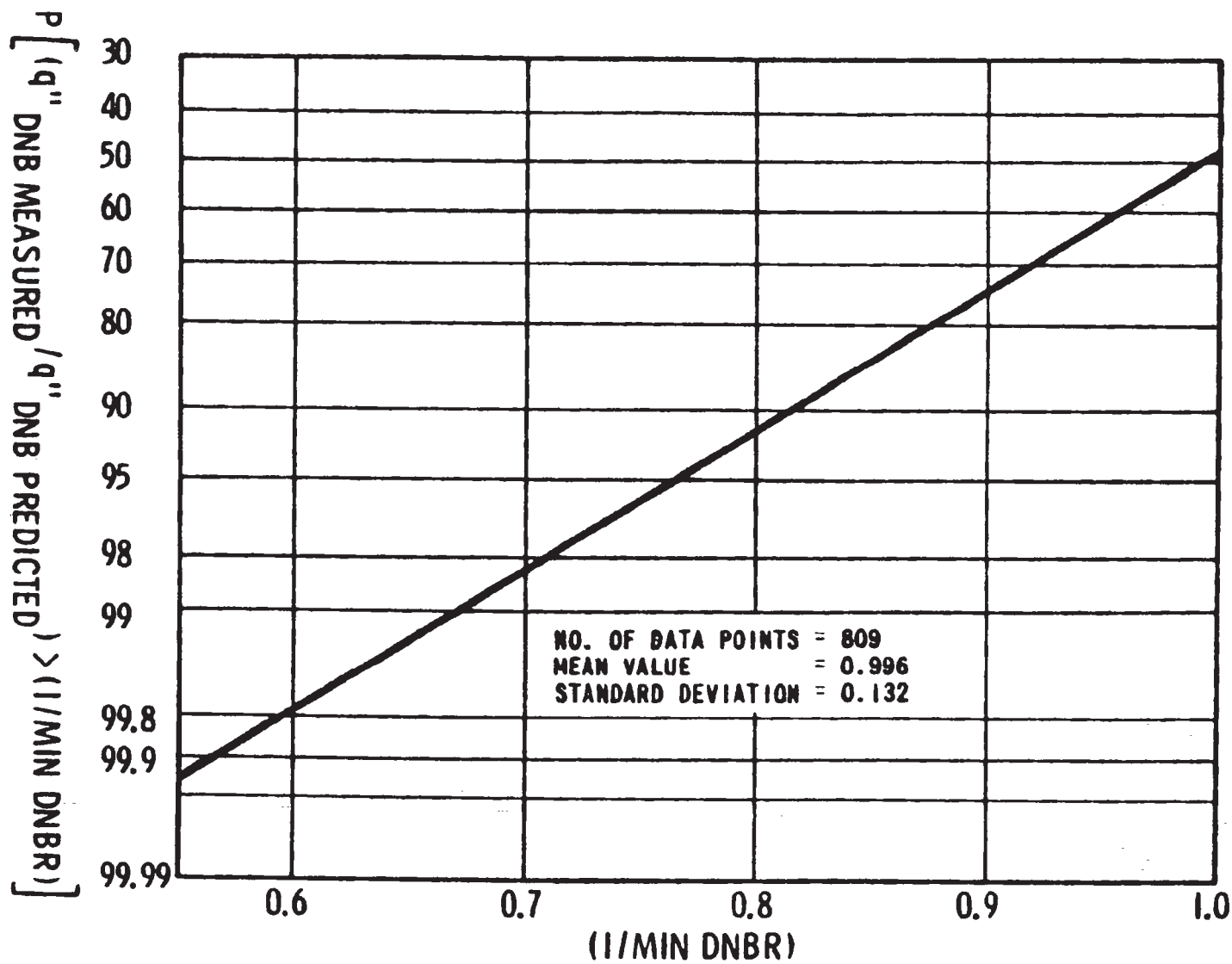

W-3 CORRELATION PROBABILITY DISTRIBUTION CURVE

| | |
|---|--------------|
| INDIAN POINT UNIT No. 2 | |
| UFSAR FIGURE 3.2-41 TYPICAL | |
| W-3 CORRELATION PROBABILITY DISTRIBUTION CURVE | |
| MIC. No. 1999MC3678 | REV. No. 17B |

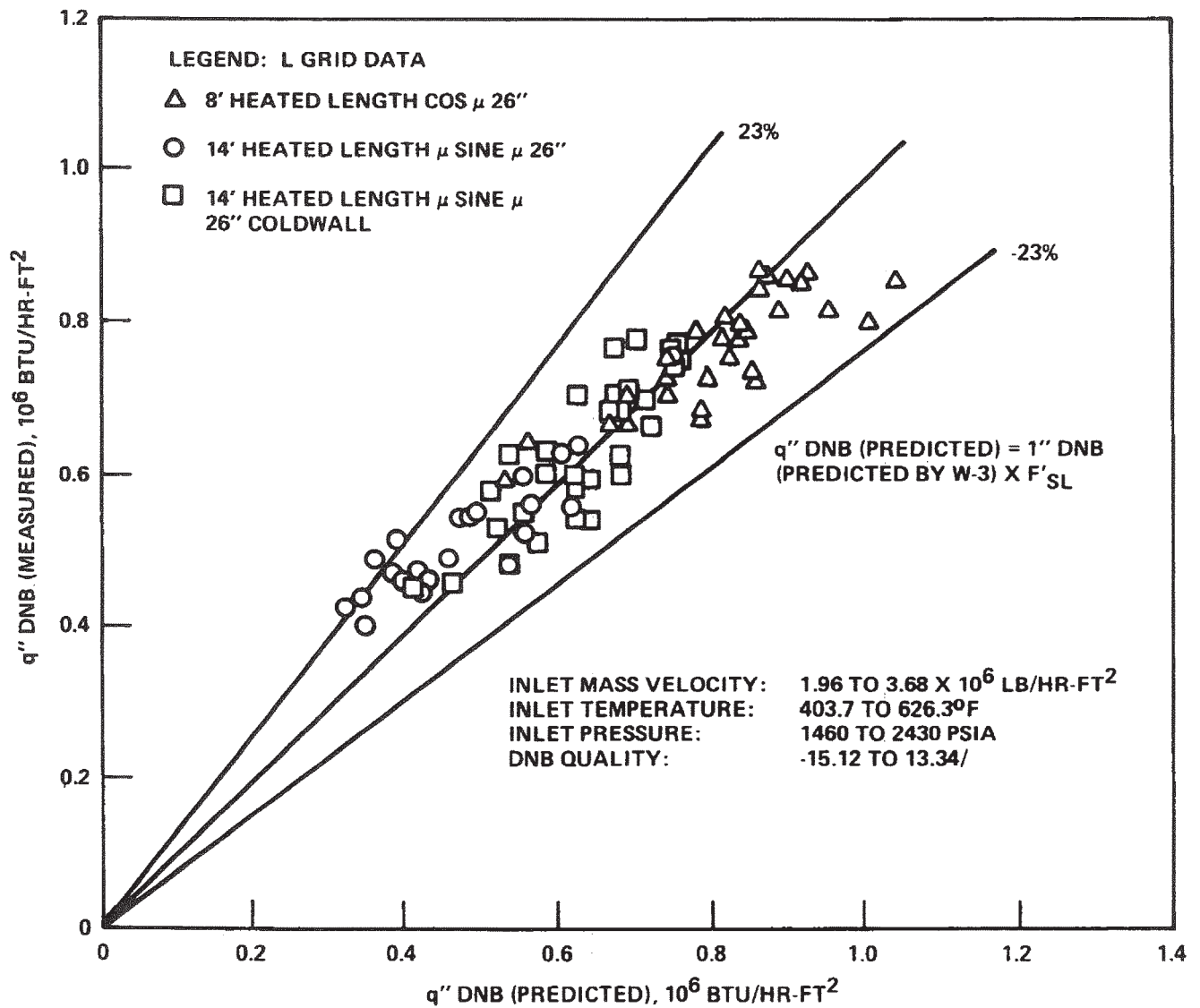

INDIAN POINT UNIT No. 2

UFSAR FIGURE 3.2-42

COMPARISON OF "L" GRID TYPICAL AND THIMBLE COLD WALL CELL ROD BUNDLE DNB DATA FOR NON-UNIFORM AXIAL HEAT FLUX WITH PREDICTIONS OF $W-3 \times F'SL$

MIC. No. 1999MC3679

REV. No. 17A

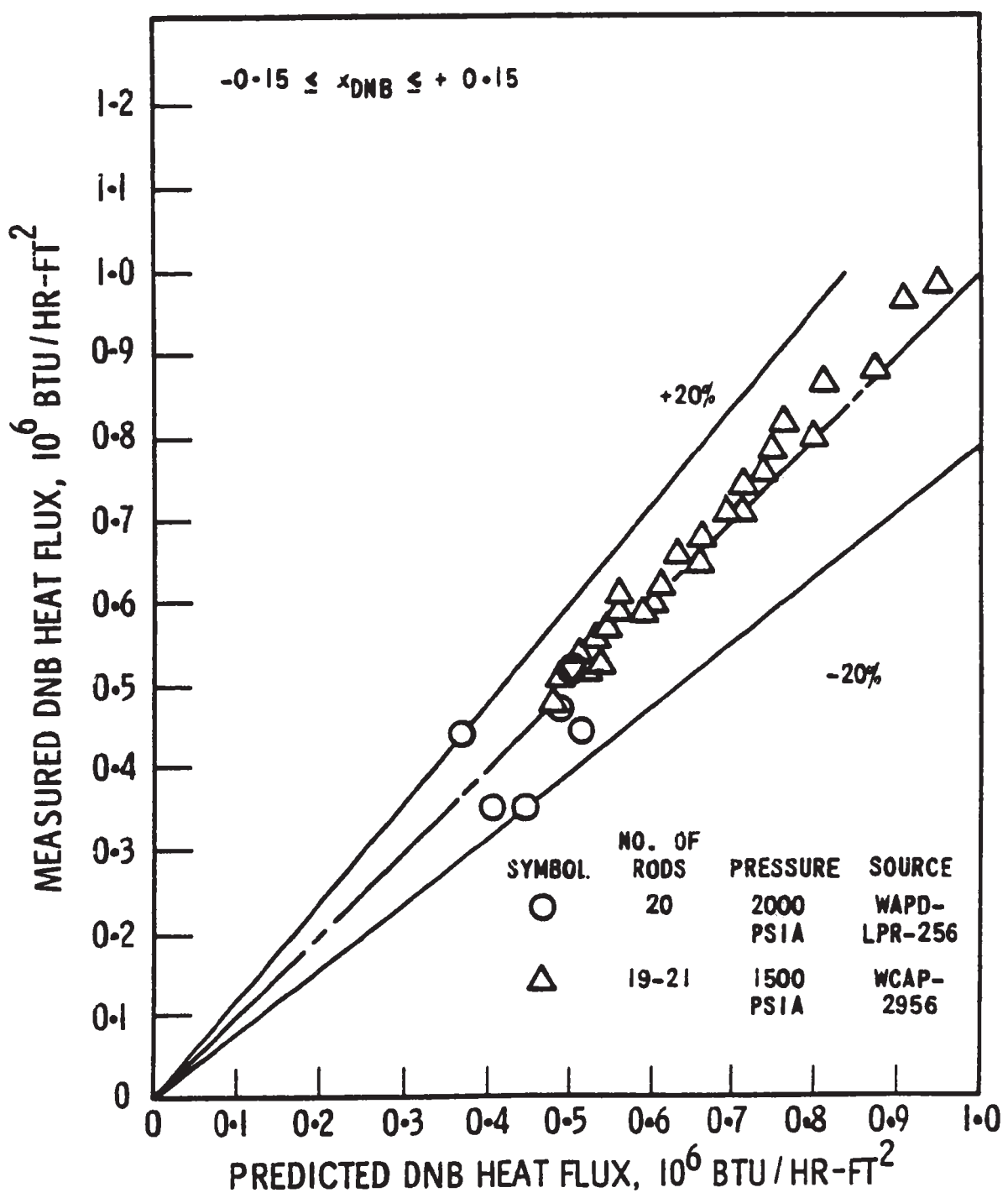

INDIAN POINT UNIT No. 2

UFSAR FIGURE 3.2-43
TYPICAL

COMPARISON OF W-3 CORRELATION
WITH ROD BUNDLE DNB DATA
(SIMPLE GRID WITHOUT MIXING VANE)

| | |
|---------------------|--------------|
| MIC. No. 1999MC3680 | REV. No. 17B |
|---------------------|--------------|

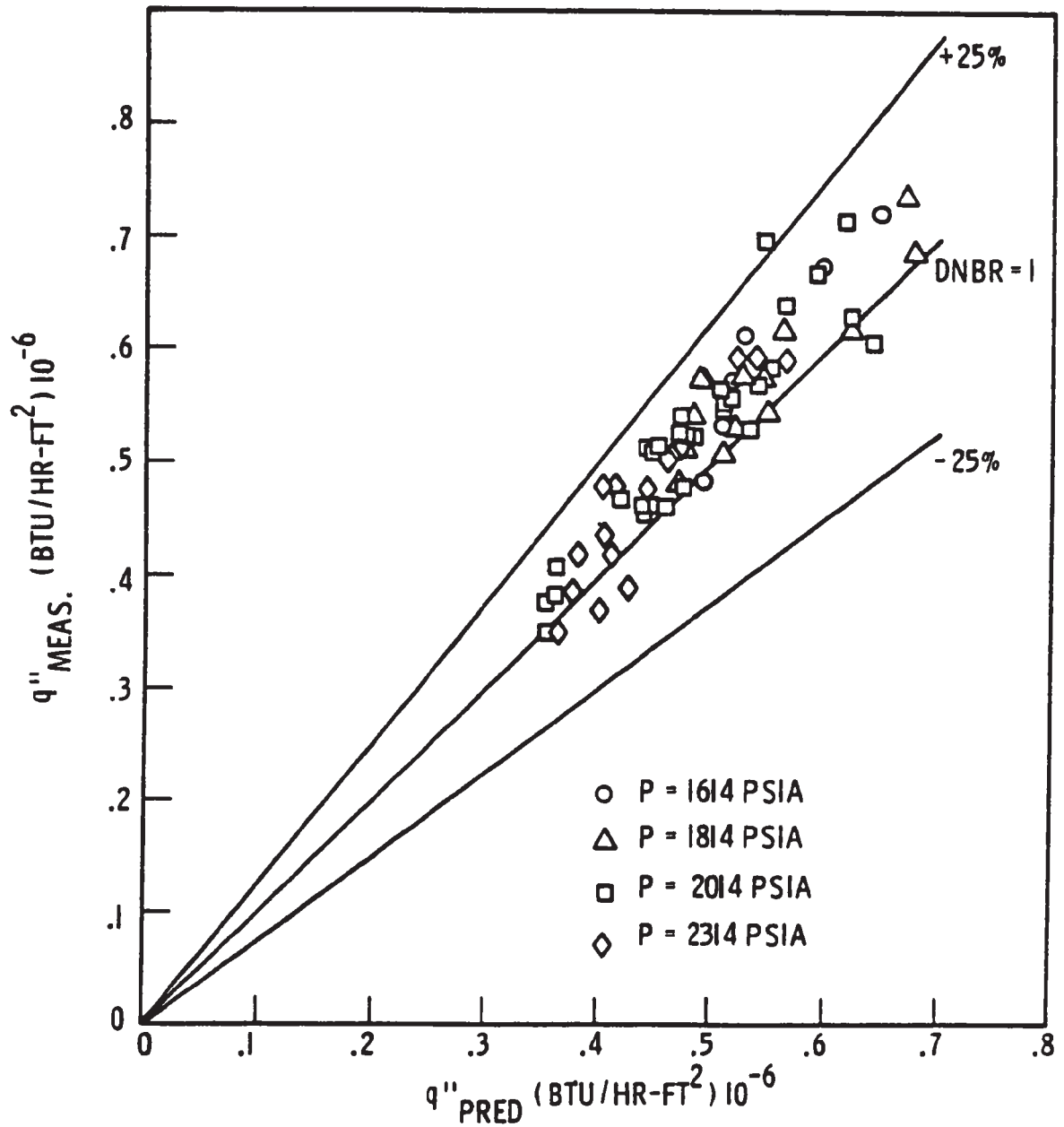

INDIAN POINT UNIT No. 2

UFSAR FIGURE 3.2-44
 TYPICAL
 COMPARISON OF W-3 CORRELATION
 WITH ROD BUNDLE DNB DATA
 (SIMPLE GRID WITH MIXING VANE)

MIC. No. 1999MC3681

REV. No. 17B

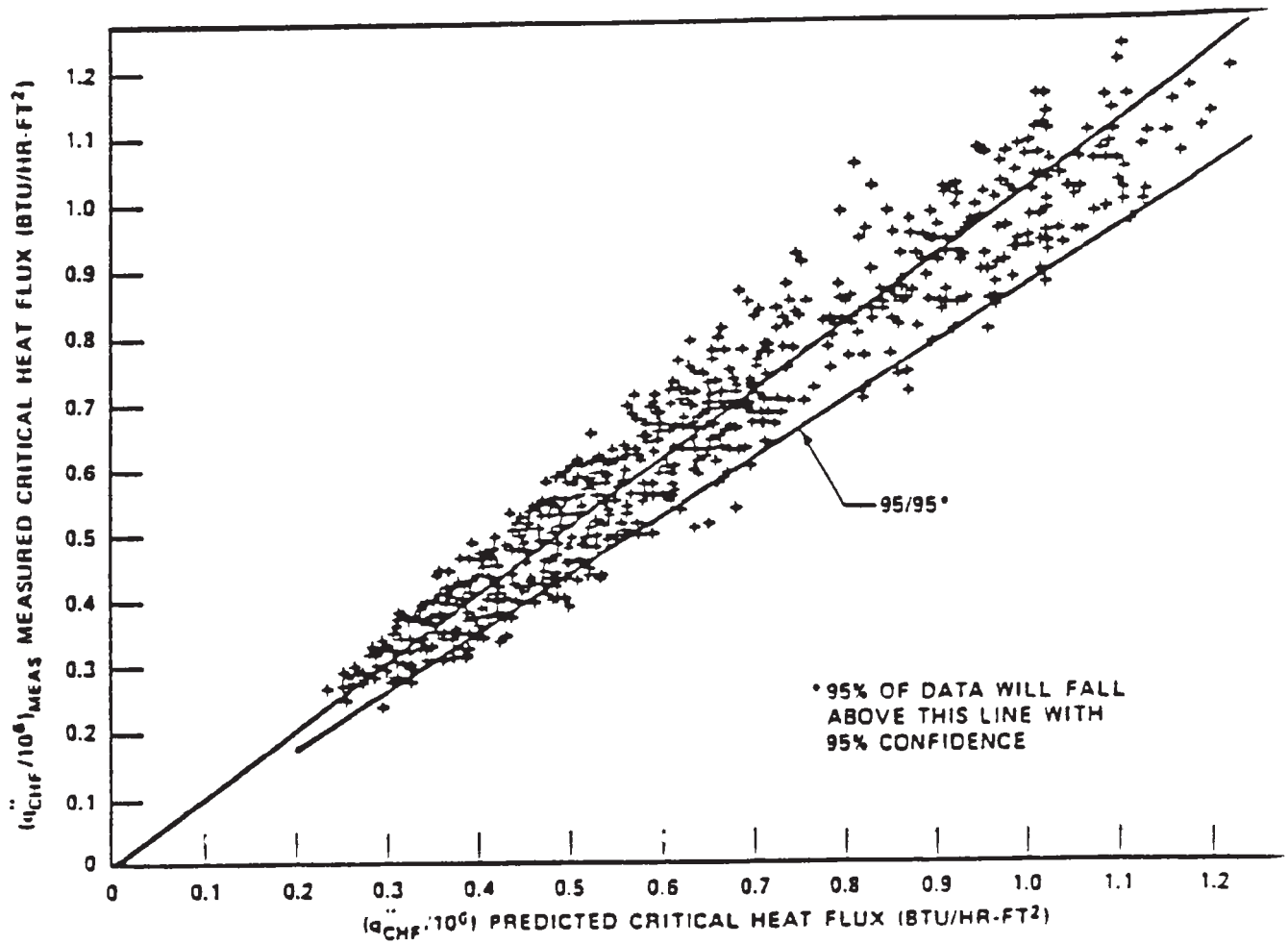

| | |
|---|--------------|
| INDIAN POINT UNIT No. 2 | |
| UFSAR FIGURE 3.2-44A TYPICAL | |
| MEASURED VERSUS PREDICTED CRITICAL HEAT FLUX-WRB-1 CORRELATION | |
| MIC. No. 1999MC3682 | REV. No. 17B |

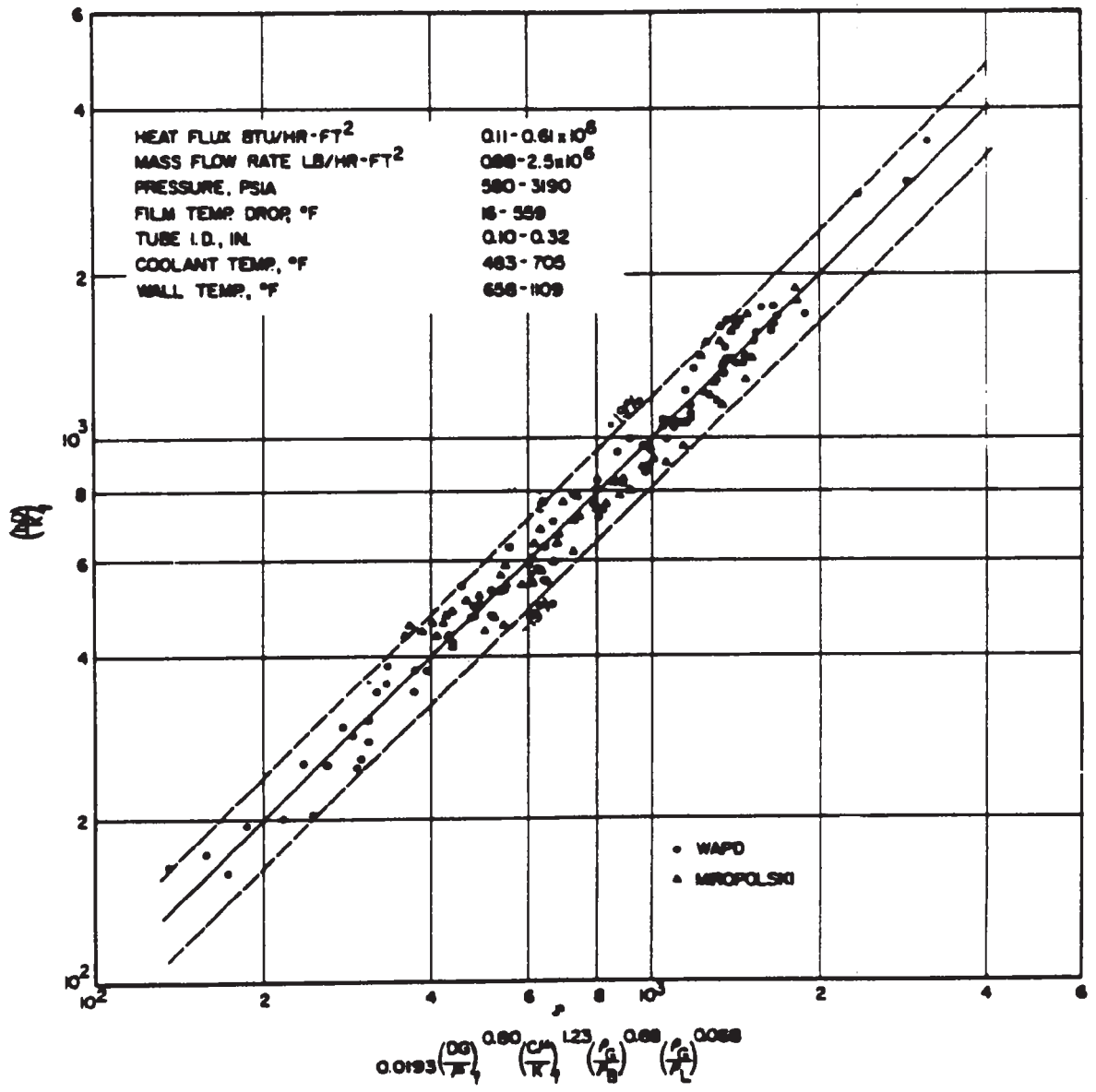

INDIAN POINT UNIT No. 2

UFSAR FIGURE 3.2-45
 TYPICAL

STABLE FILM BOILING HEAT TRANSFER
 DATA AND CORRELATION

MIC. No. 1999MC3683 | REV. No. 17B

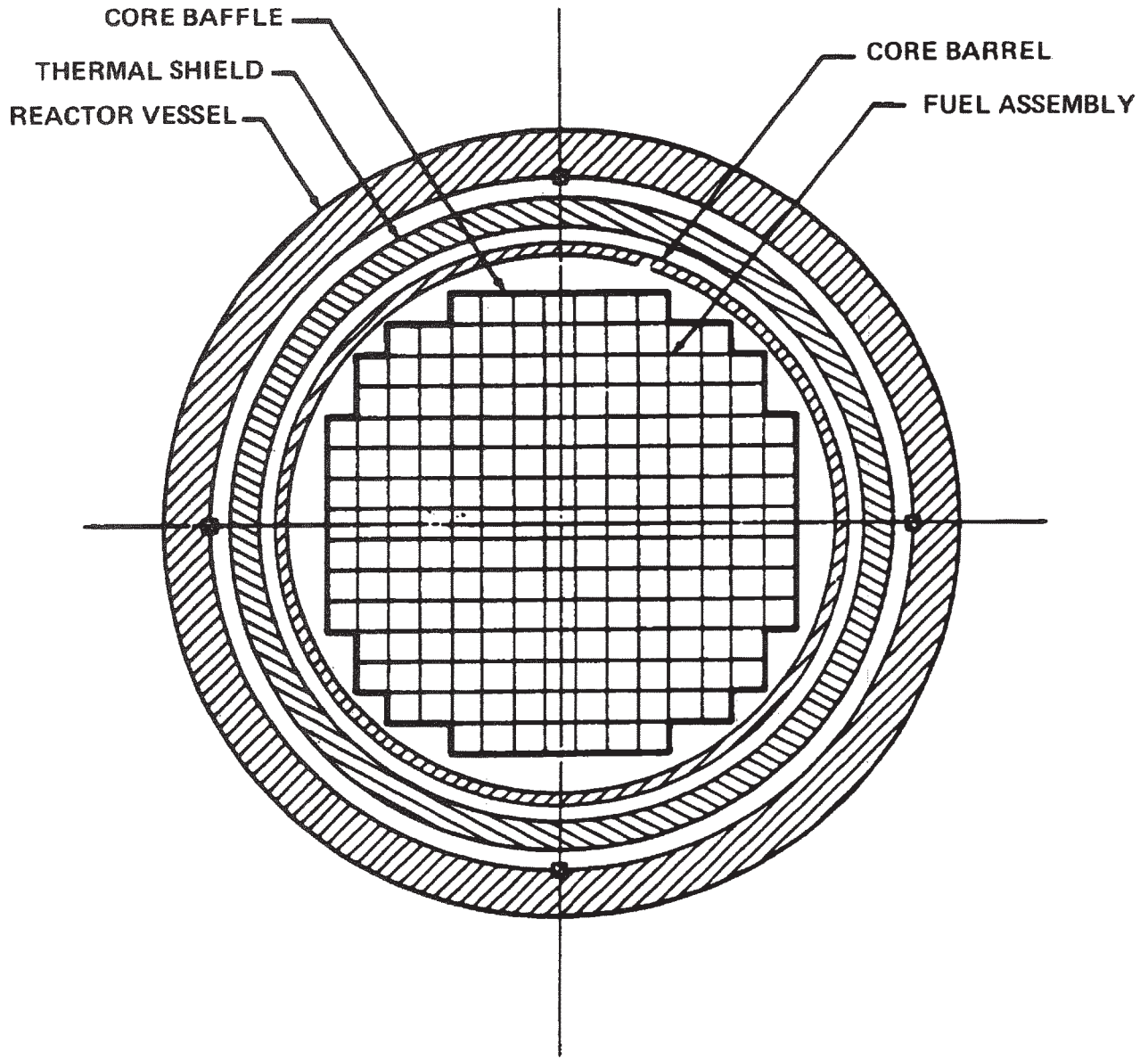

193 FUEL ASSEMBLIES

INDIAN POINT UNIT No. 2

UFSAR FIGURE 3.2-46

CORE CROSS SECTION

MIC. No. 1999MC3684

REV. No. 17A

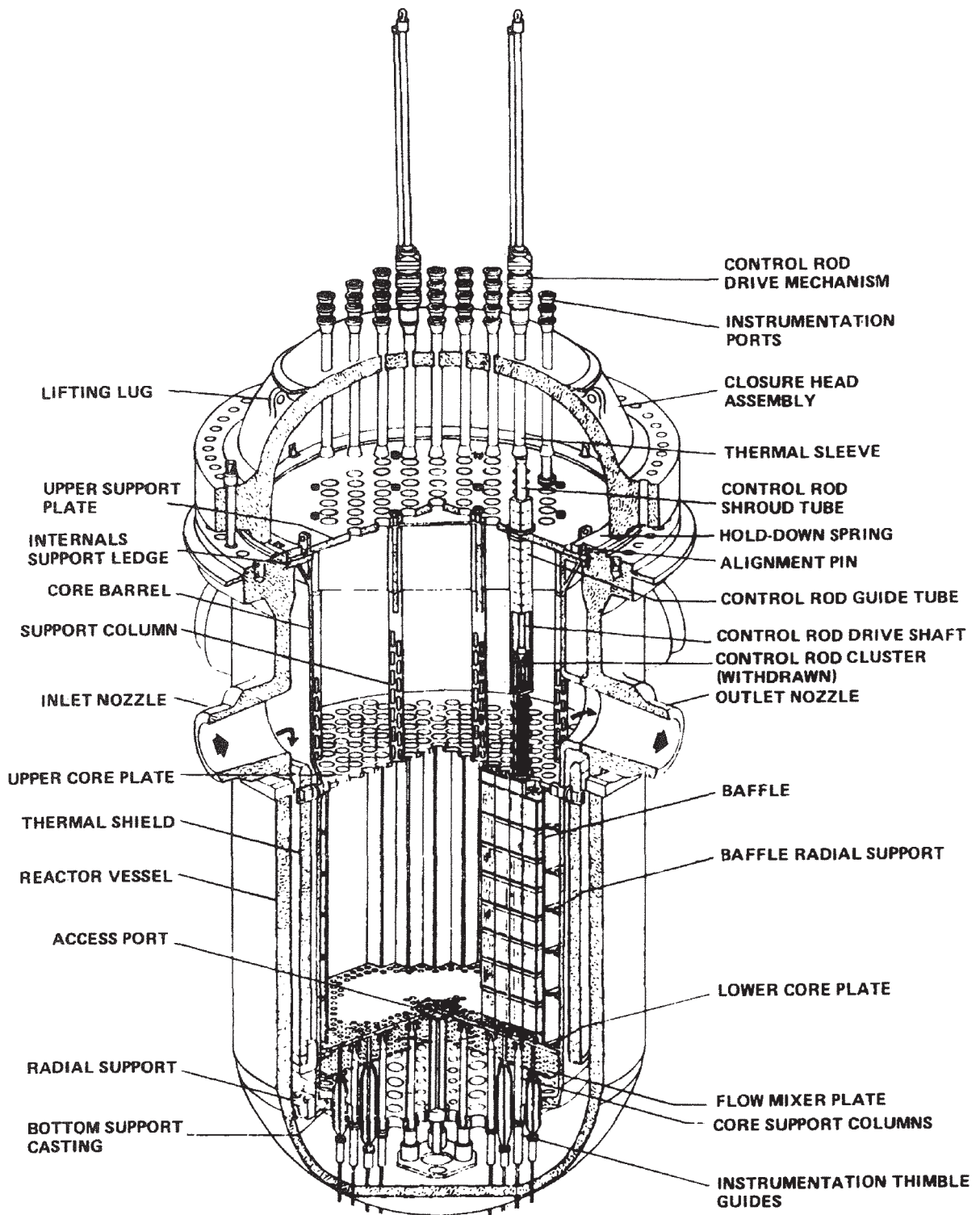

INDIAN POINT UNIT No. 2

UFSAR FIGURE 3.2-47

REACTOR VESSEL INTERNALS

MIC. No. 1999MC3685

REV. No. 17A

90°

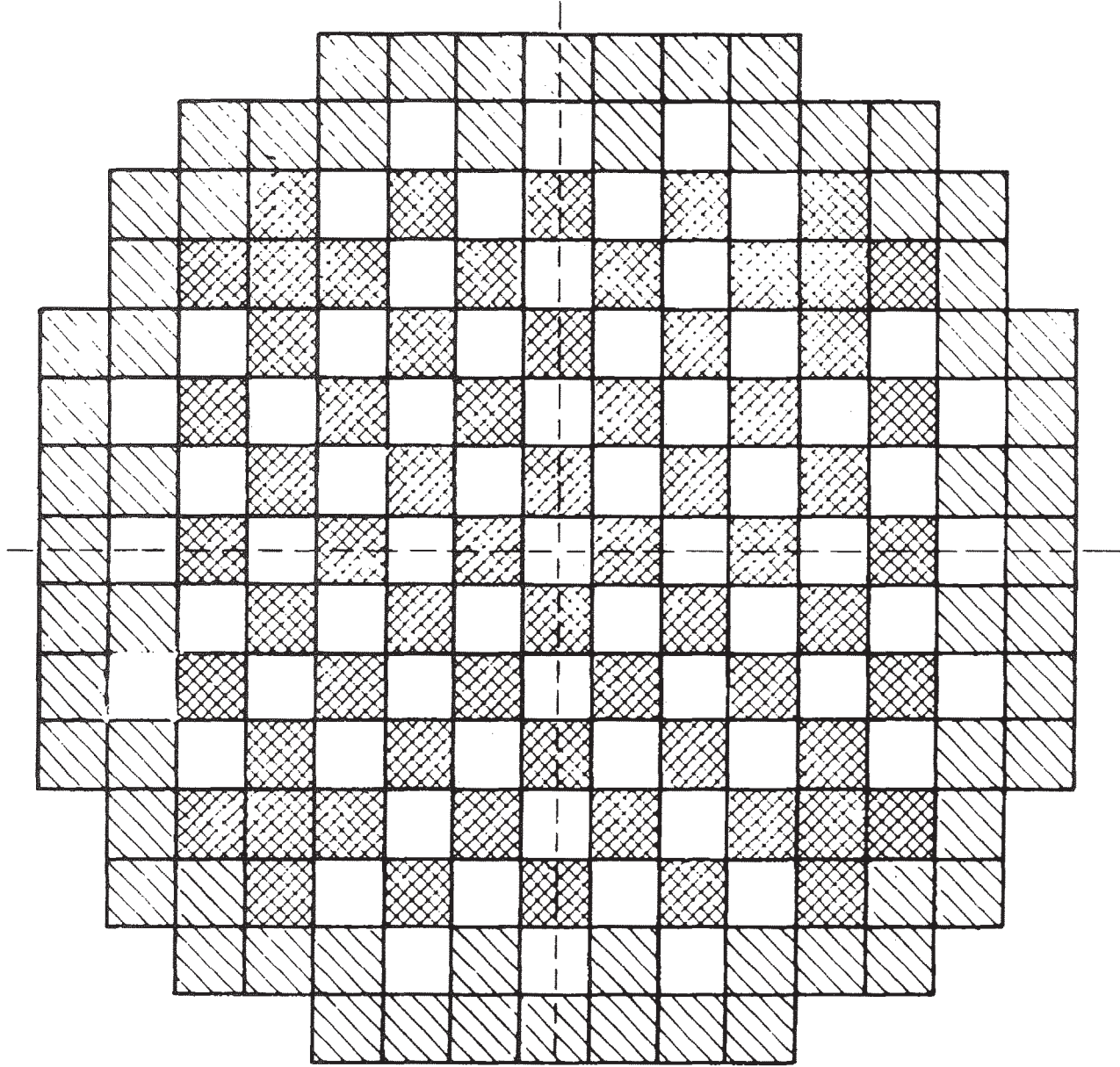

ENRICHMENTS



2.2 W/O



2.8 W/O



3.3 W/O

INDIAN POINT UNIT No. 2

UFSAR FIGURE 3.2-48

CORE LOADING ARRANGEMENT
- CYCLE 1

MIC. No. 1999MC3686

REV. No. 17A

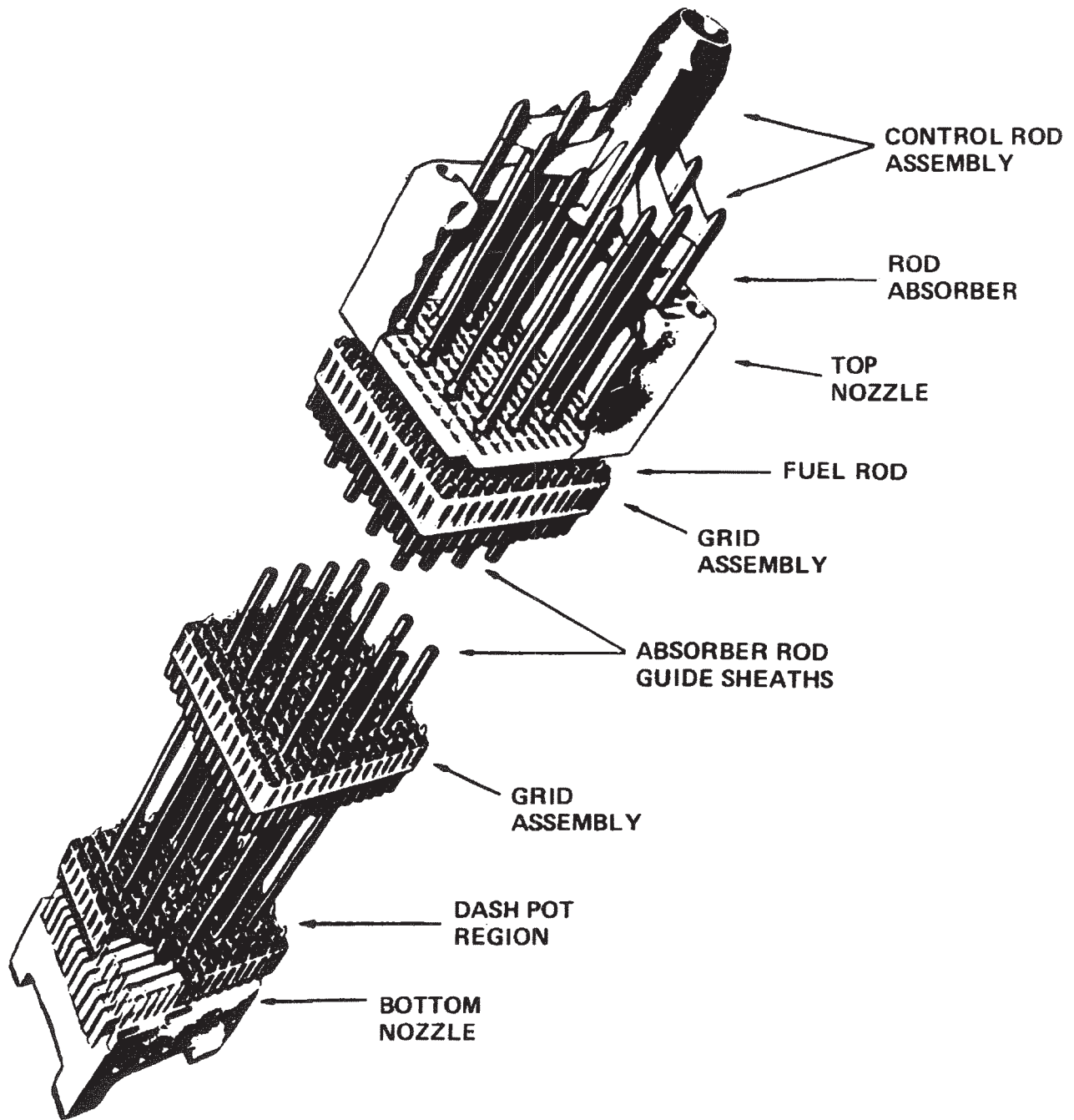

INDIAN POINT UNIT No. 2

UFSAR FIGURE 3.2-49

TYPICAL ROD CLUSTER
CONTROL ASSEMBLY

MIC. No. 1999MC3687

REV. No. 17A

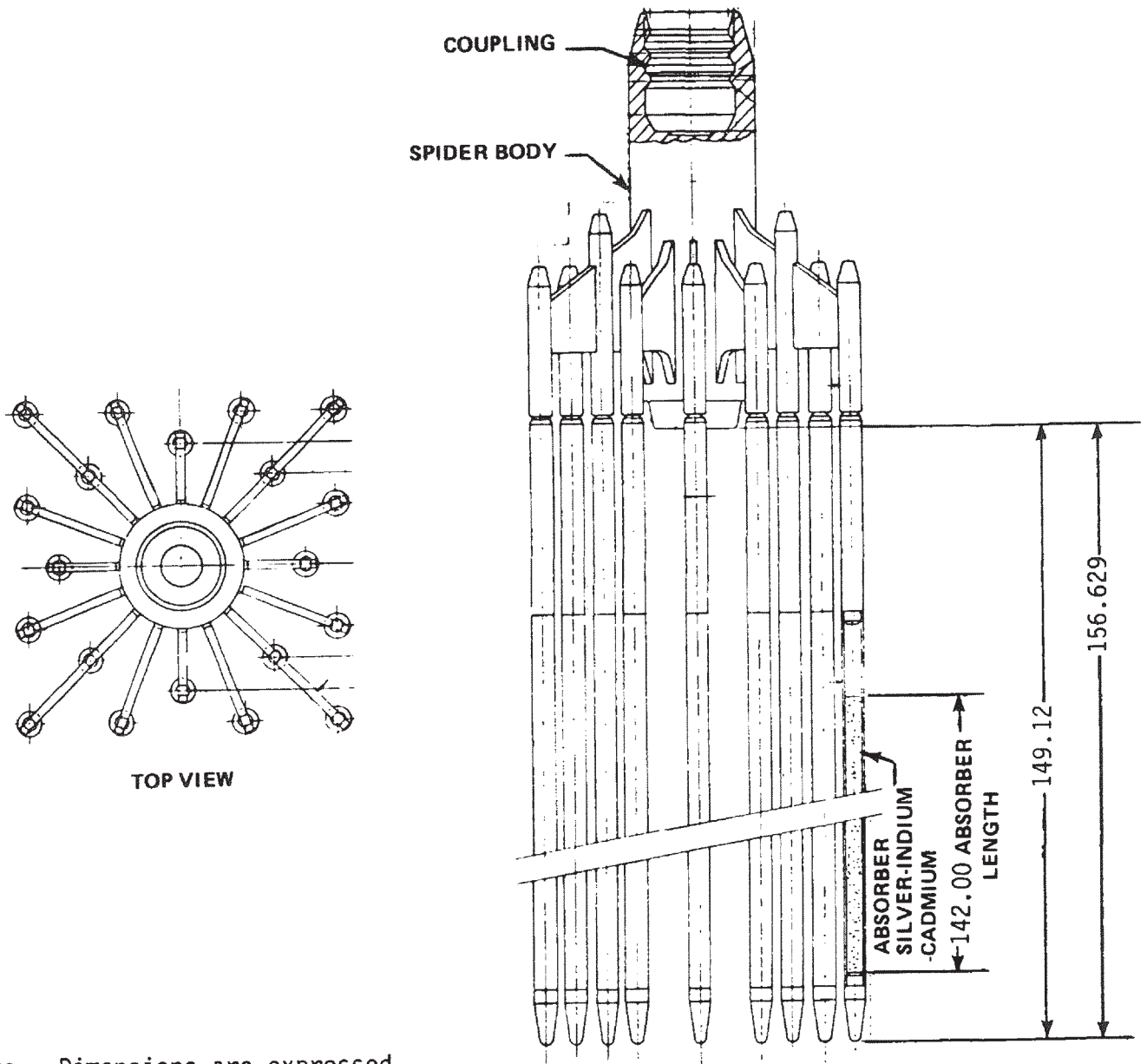

Note: Dimensions are expressed in inches.

INDIAN POINT UNIT No. 2

UFSAR FIGURE 3.2-50

ROD CONTROL CLUSTER
ASSEMBLY OUTLINE

MIC. No. 1999MC3688

REV. No. 17A

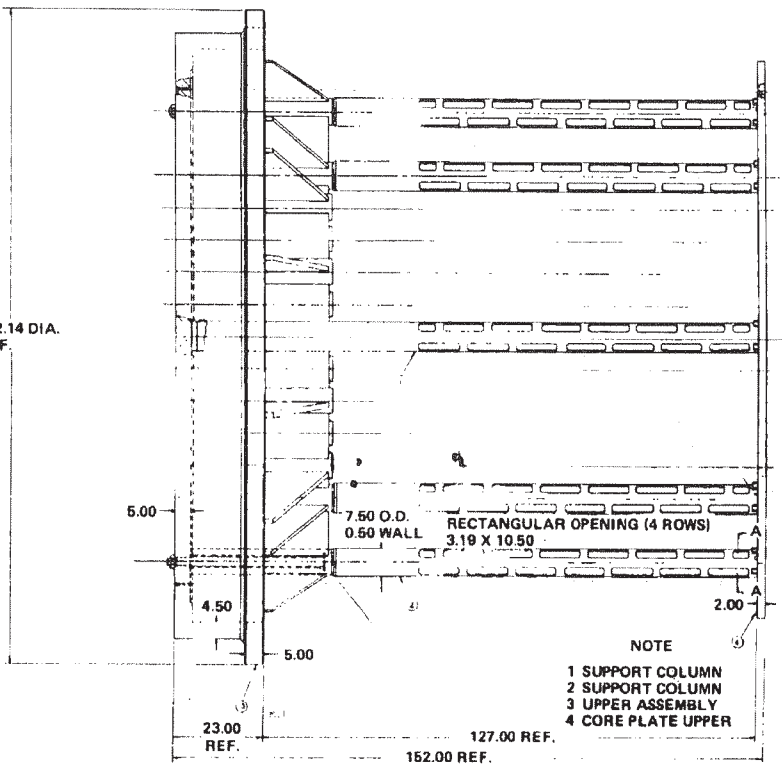

172.14 DIA.
REF.

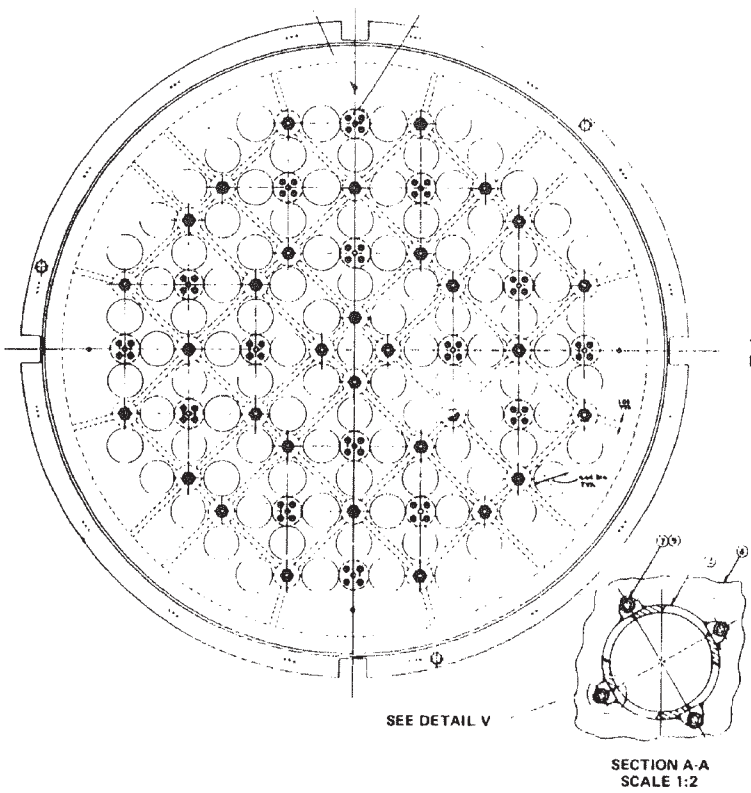

Note: Dimensions are expressed
in inches.

INDIAN POINT UNIT No. 2

UFSAR FIGURE 3.2-52

UPPER CORE
SUPPORT STRUCTURE

MIC. No. 1999MC3706 REV. No. 17A

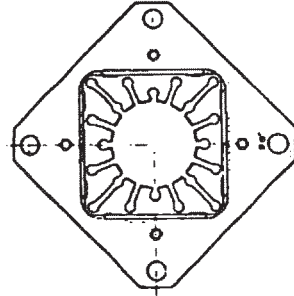
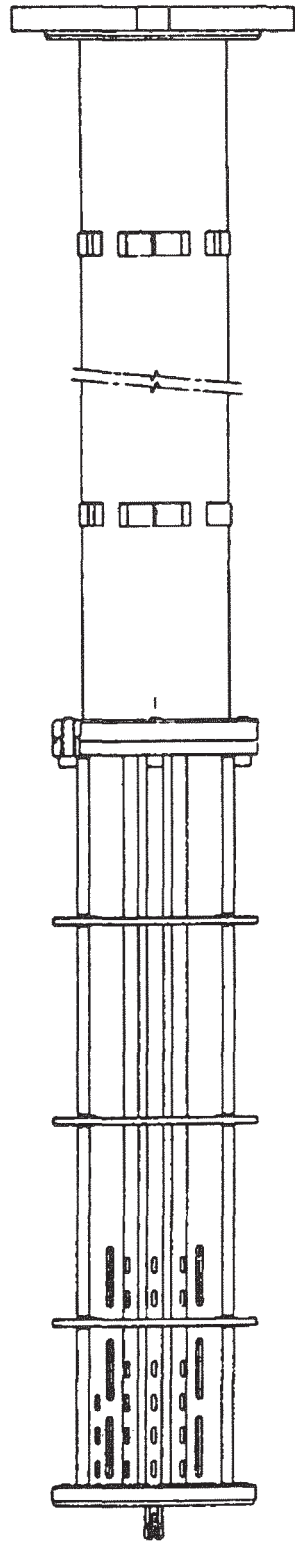

TOP VIEW

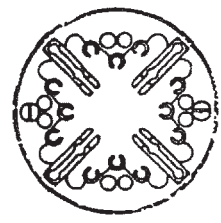

BOTTOM VIEW

INDIAN POINT UNIT No. 2

UFSAR FIGURE 3.2-53

GUIDE TUBE
ASSEMBLY

MIC. No. 1999MC3707

REV. No. 17A

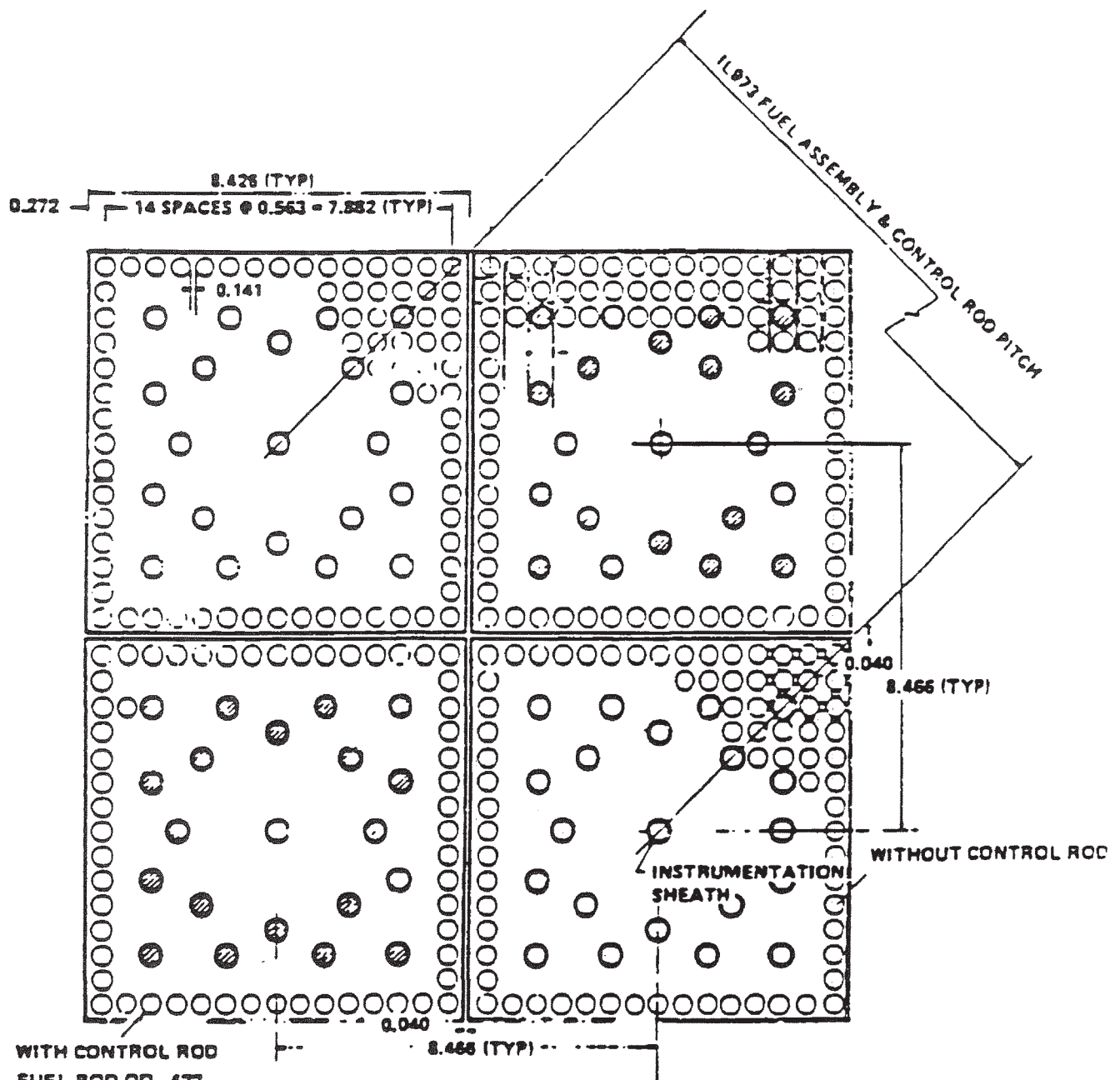

WITH CONTROL ROD
 FUEL ROD OD - .422
 CLAD THICKNESS - .0243
 CLAD MATERIAL - ZIRC (ZIRLO™ for VANTAGE+)
 FUEL RODS/ASSY - 204

Note: (1) All dim. corrected to 68°F ± 2°
 (2) Dimensions are expressed in inches

INDIAN POINT UNIT No. 2

UFSAR FIGURE 3.2-54
 FUEL ASSEMBLY AND CONTROL CLUSTER
 CROSS SECTION -
 HIPAR, LOPAR, OFA AND VANTAGE+

MIC. No. 1999MC3708

REV. No. 17A

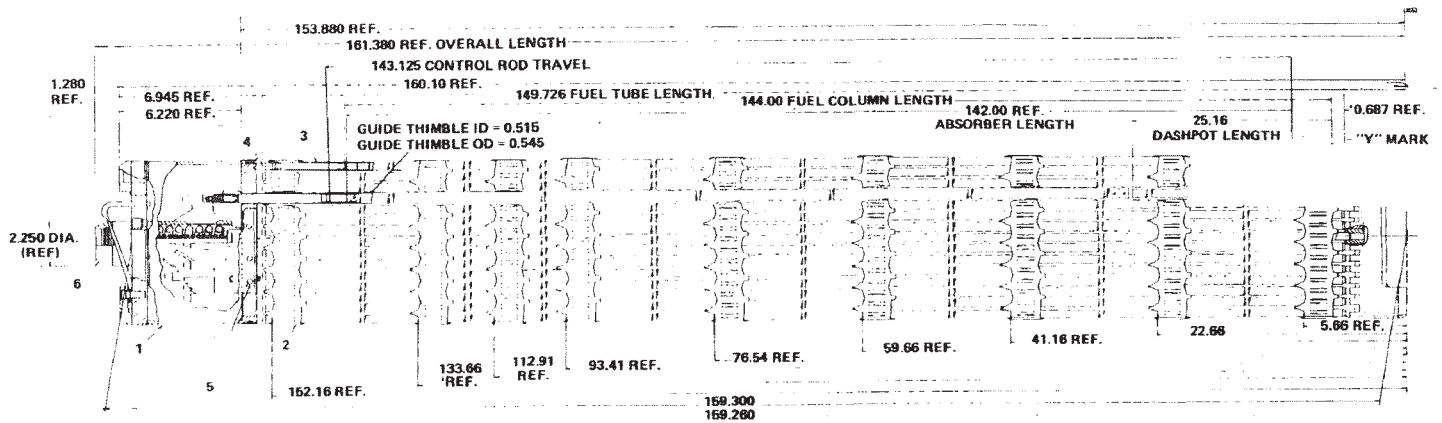

Note: Dimensions are expressed in inches.

INDIAN POINT UNIT No. 2

UFSAR FIGURE 3.2-55

HIPAR
 FUEL ASSEMBLY

MIC. No. 1999MC3709

REV. No. 17A

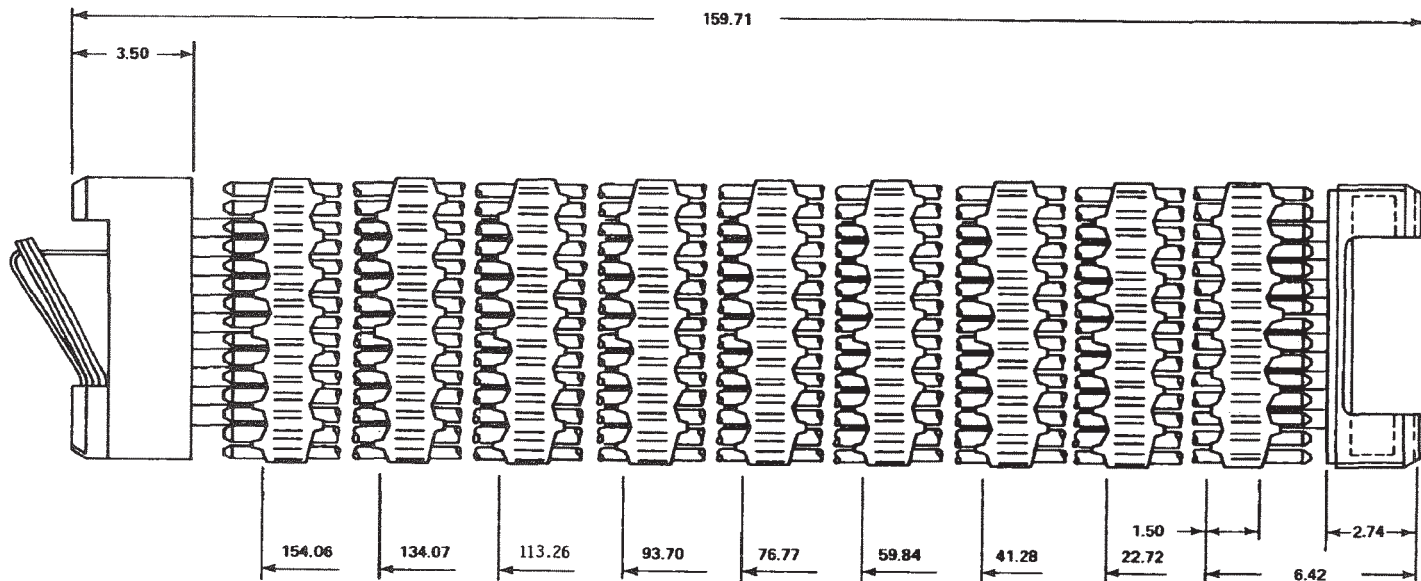

Note: Dimensions are expressed in inches.

INDIAN POINT UNIT No. 2

UFSAR FIGURE 3.2-56

LOPAR FUEL
ASSEMBLY

MIC. No. 1999MC3710

REV. No. 17A

OPTIMIZED (OFA) FUEL ASSEMBLY

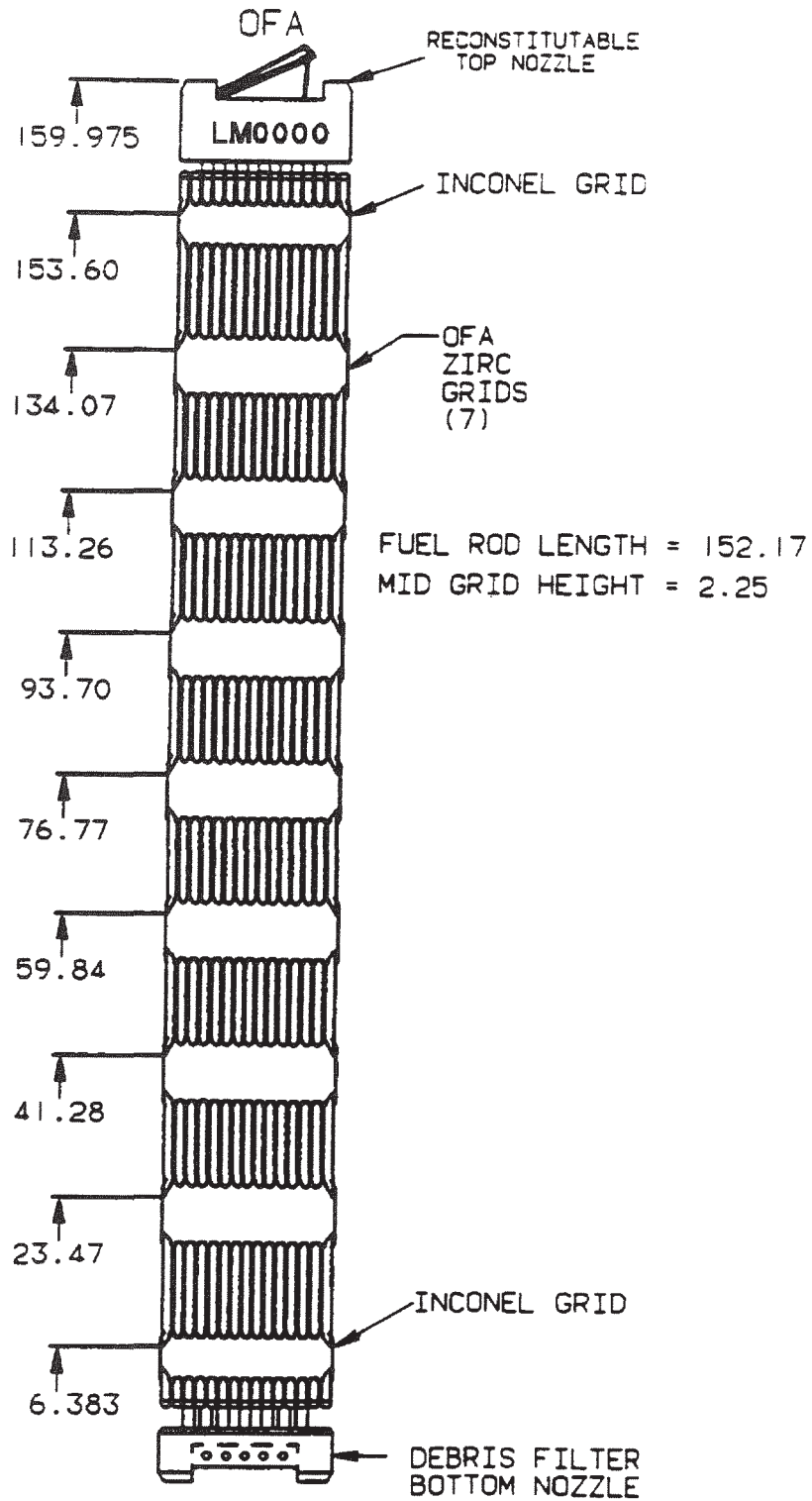

INDIAN POINT UNIT No. 2

UFSAR FIGURE 3.2-56A

OFA FUEL
ASSEMBLY

MIC. No. 1999MC3711

REV. No. 17A

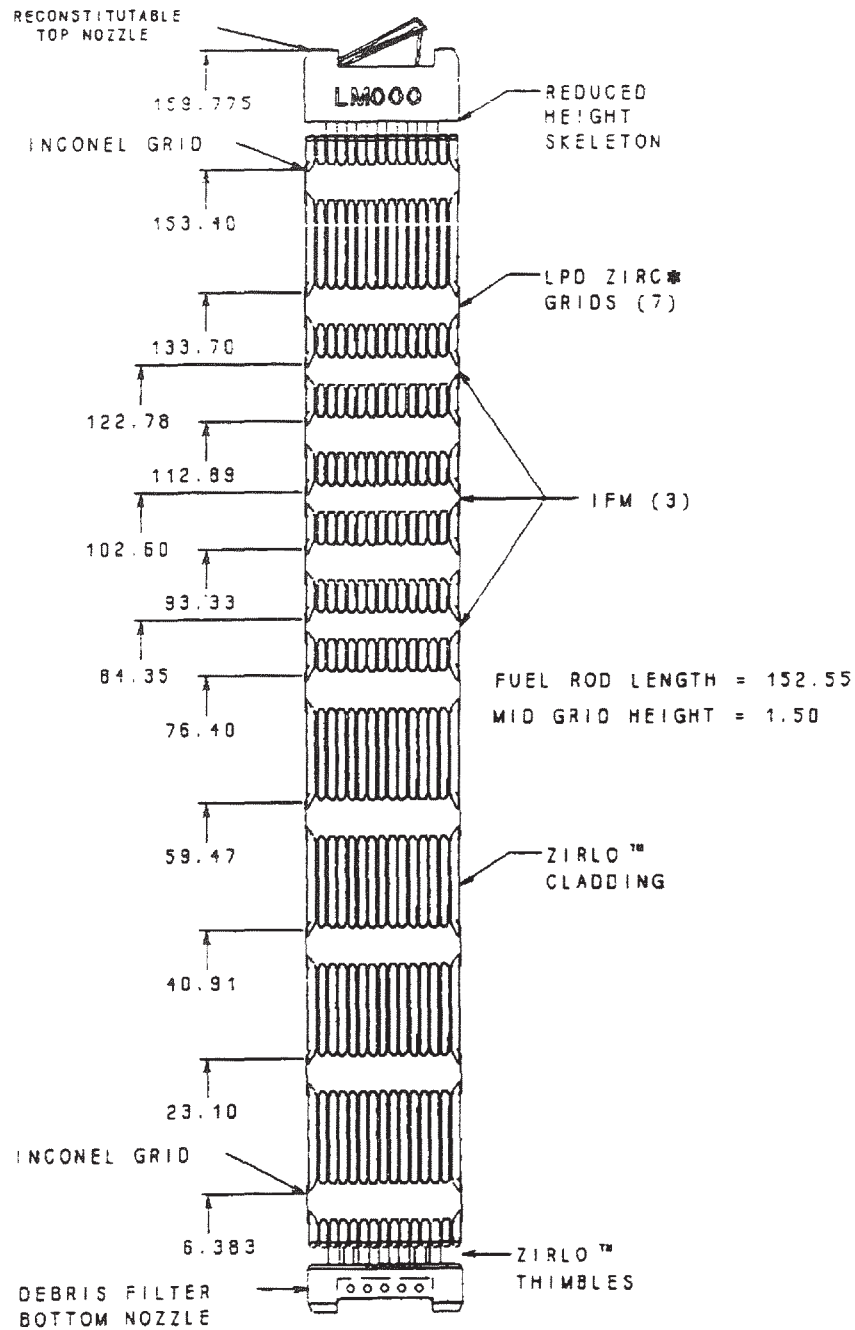

INDIAN POINT UNIT No. 2

UFSAR FIGURE 3.2-56B

VANTAGE+ FUEL ASSEMBLY

MIC. No. 1999MC3712

REV. No. 17A

* VANTAGE+ FUEL WITH PERFORMANCE + FEATURES WILL HAVE ZIRLO™ MIDGRIDS.

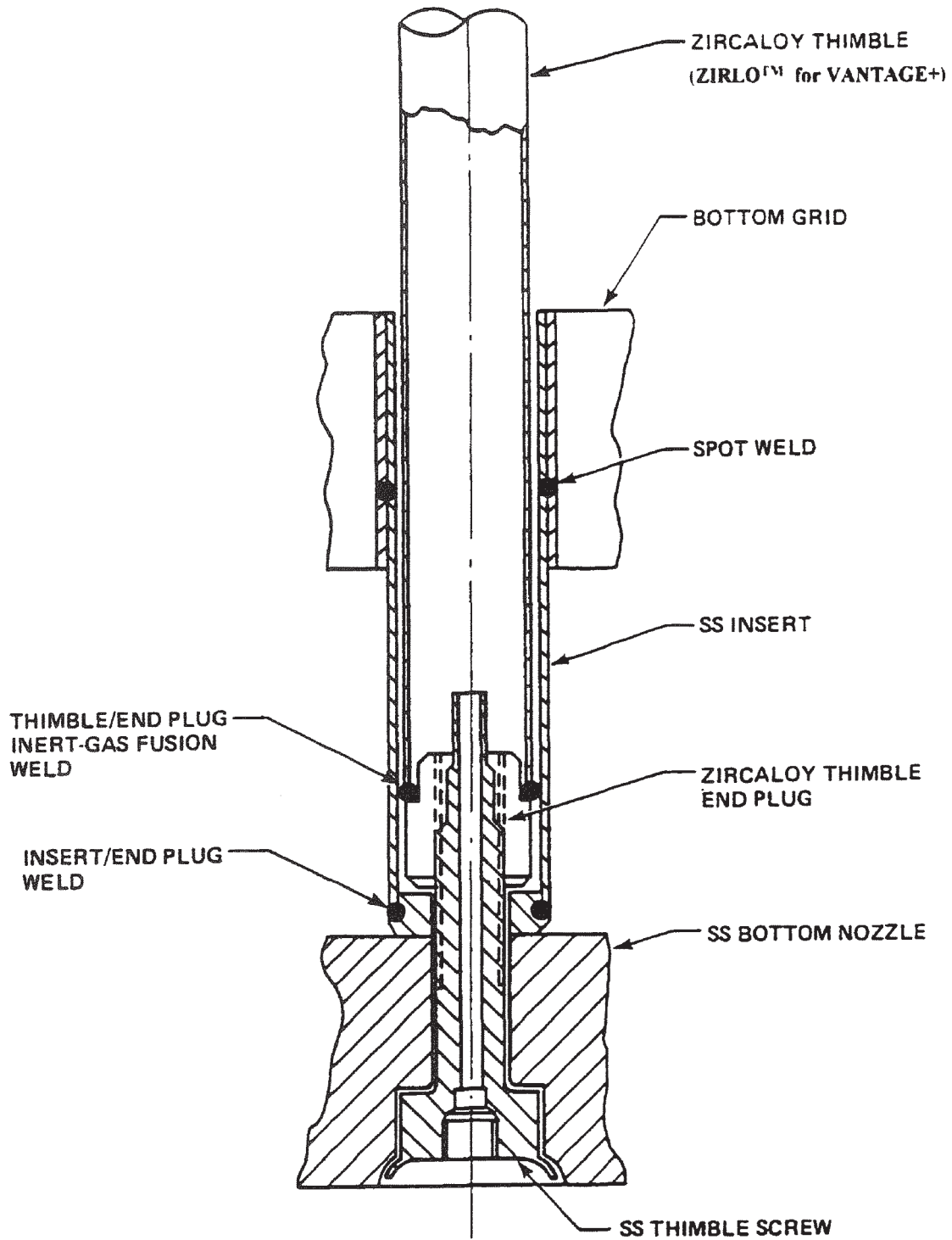

INDIAN POINT UNIT No. 2

UFSAR FIGURE 3.2-57

GUIDE THIMBLE
TO BOTTOM NOZZLE JOINT

MIC. No. 1999MC3713

REV. No. 17A

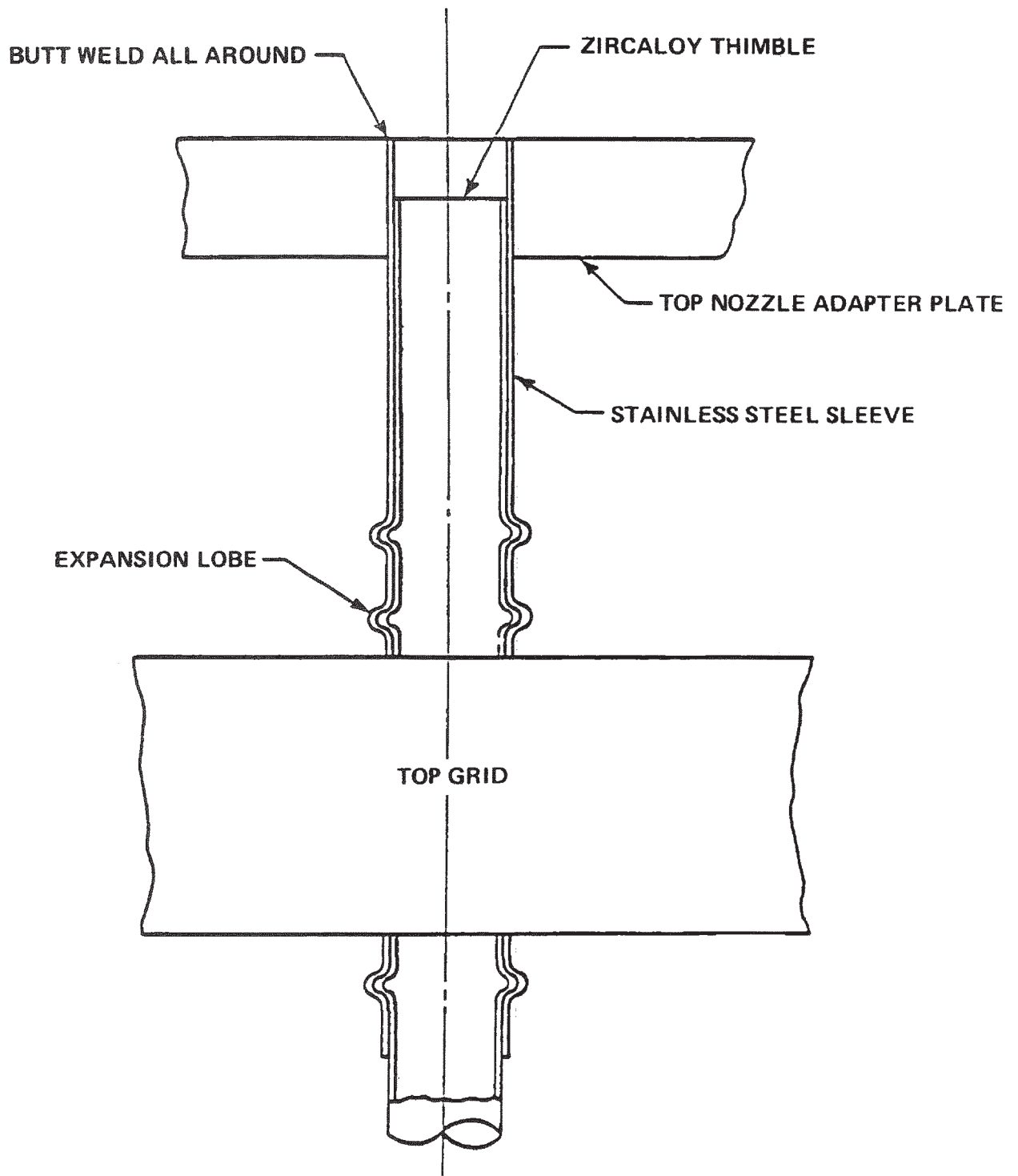

INDIAN POINT UNIT No. 2

UFSAR FIGURE 3.2-58

LOPAR TOP GRID
TO NOZZLE ATTACHMENT

MIC. No. 1999MC3714

REV. No. 17A

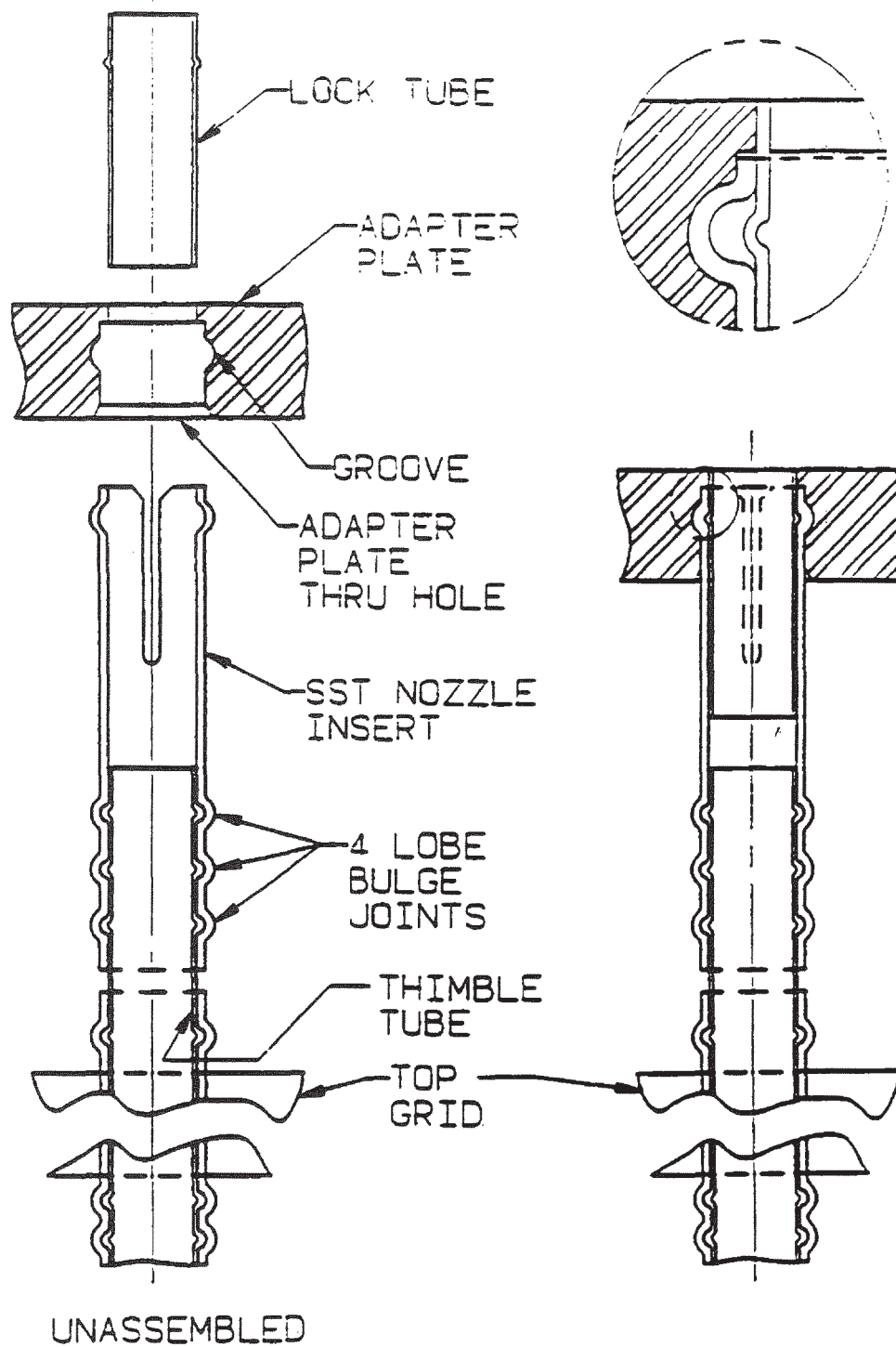

INDIAN POINT UNIT No. 2

UFSAR FIGURE 3.2-58A

OFA and VANTAGE+
TOP GRID TO NOZZLE ATTACHMENT

MIC. No. 1999MC3715

REV. No. 17A

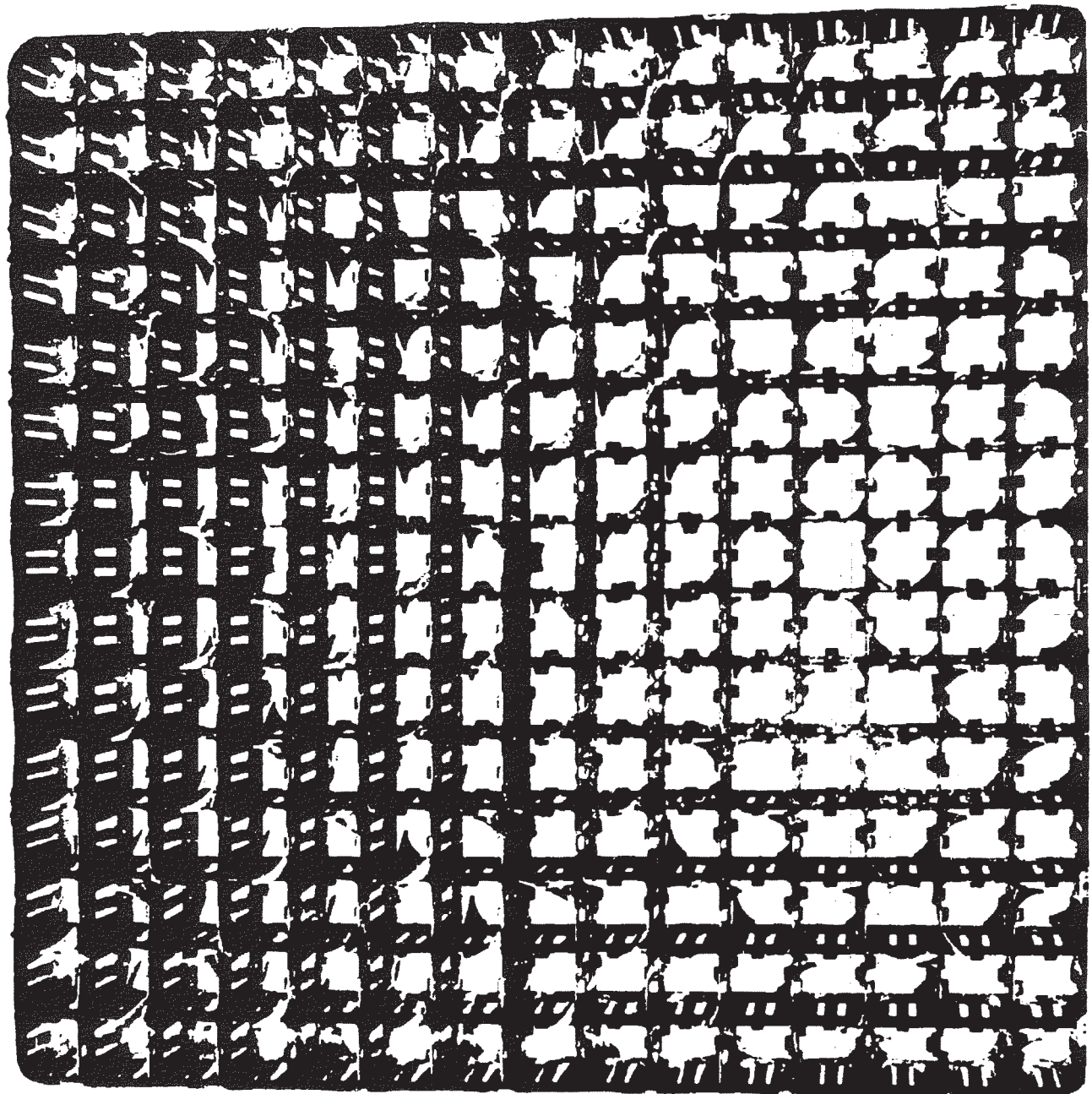

INDIAN POINT UNIT No. 2

UFSAR FIGURE 3.2-59

SPRING CLIP
GRID ASSEMBLY

MIC. No. 1999MC3716

REV. No. 17A

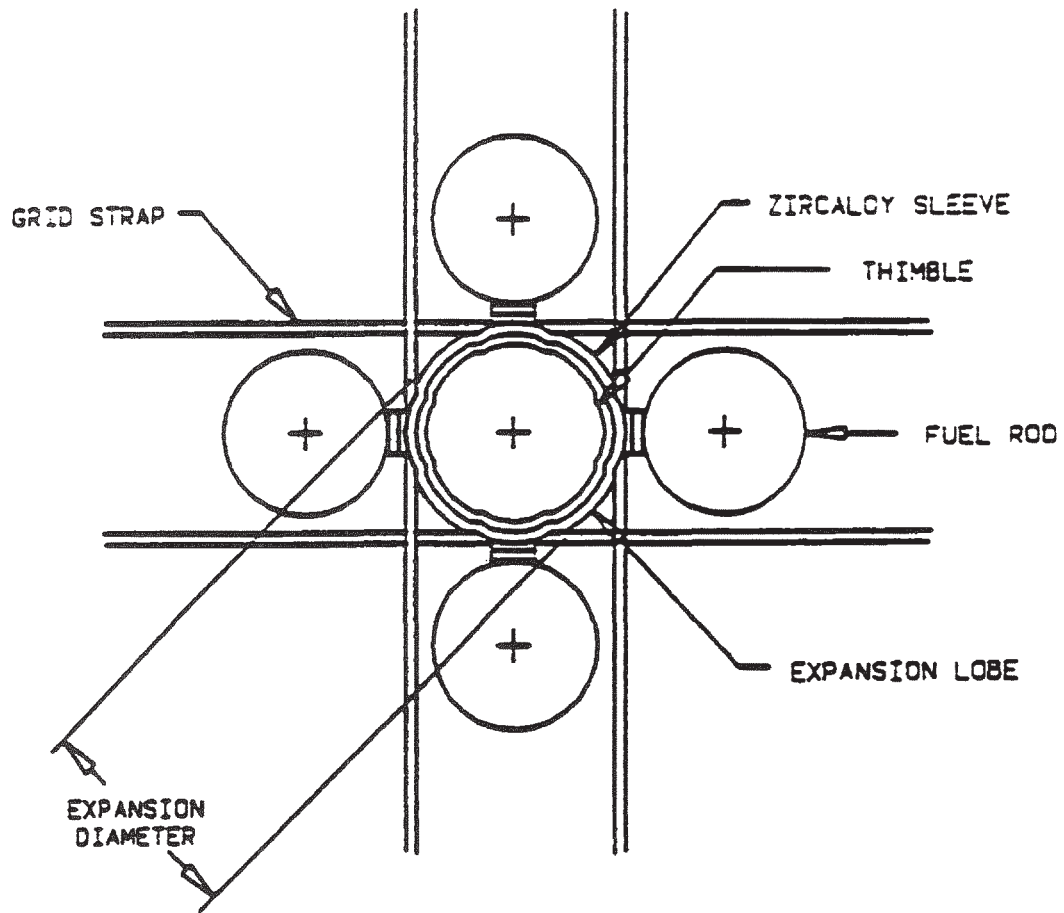

INDIAN POINT UNIT No. 2

UFSAR FIGURE 3.2-60

MID-GRID EXPANSION JOINT DESIGN
 PLAN VIEW

MIC. No. 1999MC3717

REV. No. 17A

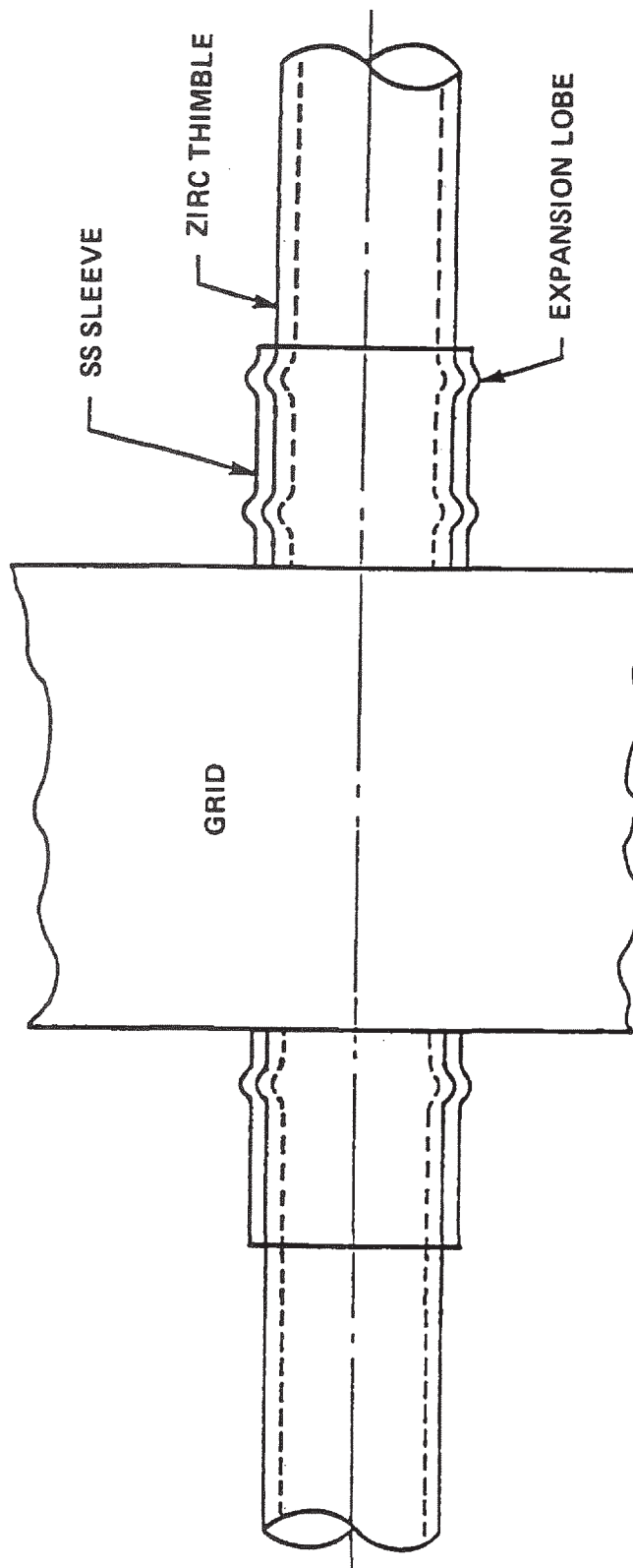

INDIAN POINT UNIT No. 2

UFSAR FIGURE 3.2-61

ELEVATION VIEW - LOPAR GRID
TO THIMBLE ATTACHMENT

MIC. No. 1999MC3718

REV. No. 17A

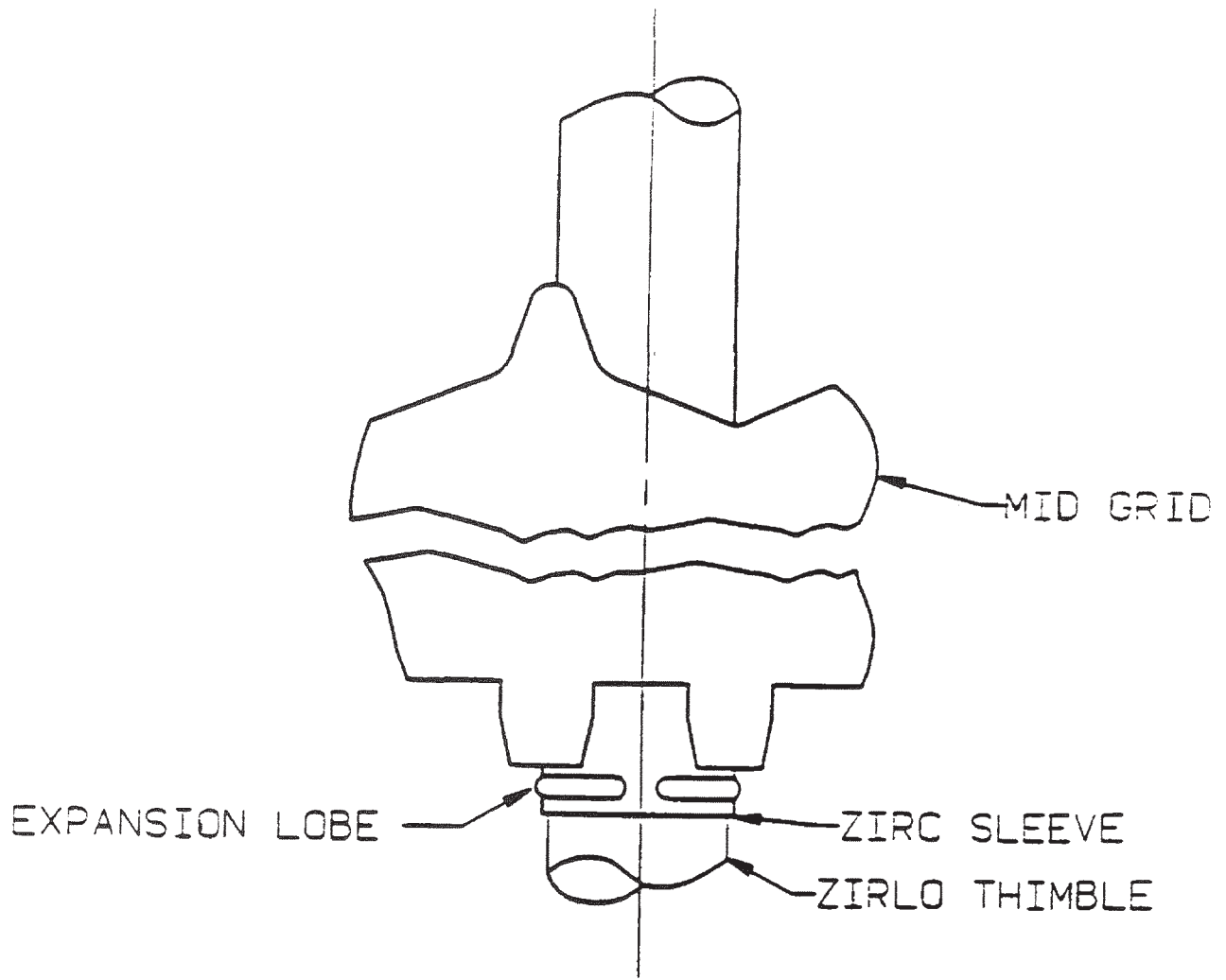

INDIAN POINT UNIT No. 2

UFSAR FIGURE 3.2-61A

ELEVATION VIEW - VANTAGE+
GRID TO THIMBLE ATTACHMENT

MIC. No. 1999MC3719

REV. No. 17A

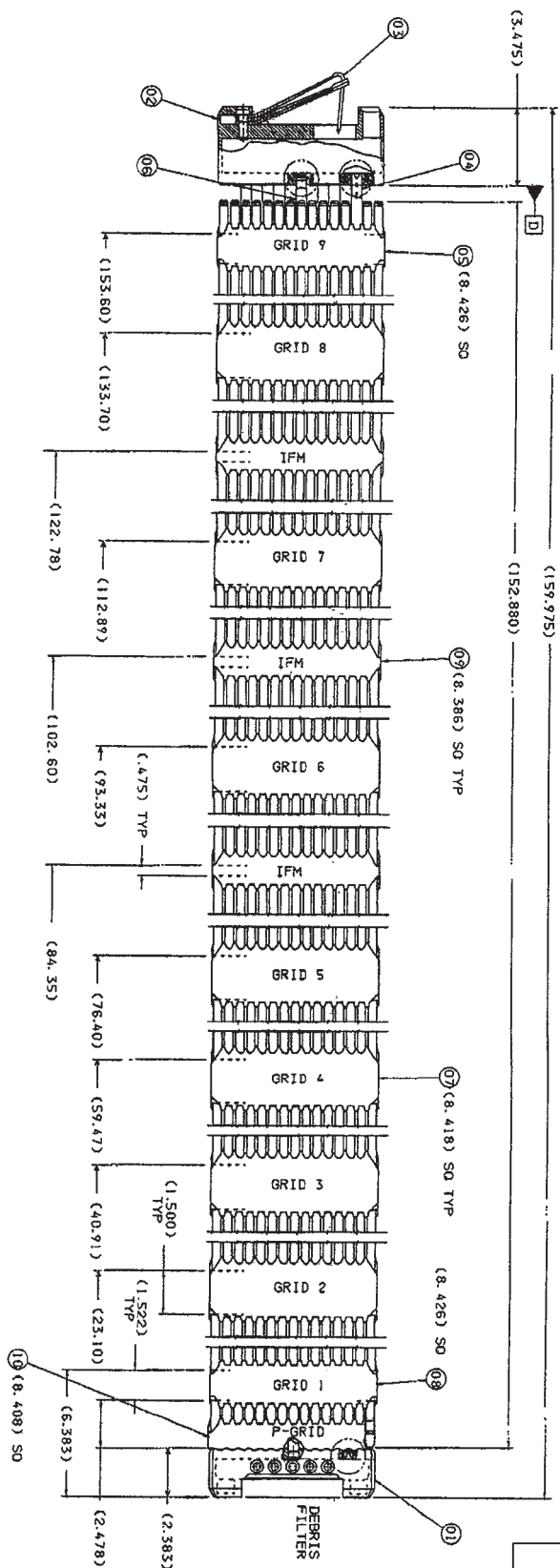

INDIAN POINT UNIT No. 2

UFSAR FIGURE 3.2-61B

VANTAGE+ FUEL ASSEMBLY
WITH PERFORMANCE+ ENHANCEMENTS

MIC. No. 1999MC3720

REV. No. 17B

U.S. GOVERNMENT WORKING COPY - NOT TO BE REPRODUCED OR TRANSMITTED IN ANY FORM OR BY ANY MEANS, ELECTRONIC OR MECHANICAL, INCLUDING PHOTOCOPYING, RECORDING, OR BY ANY INFORMATION STORAGE AND RETRIEVAL SYSTEM.

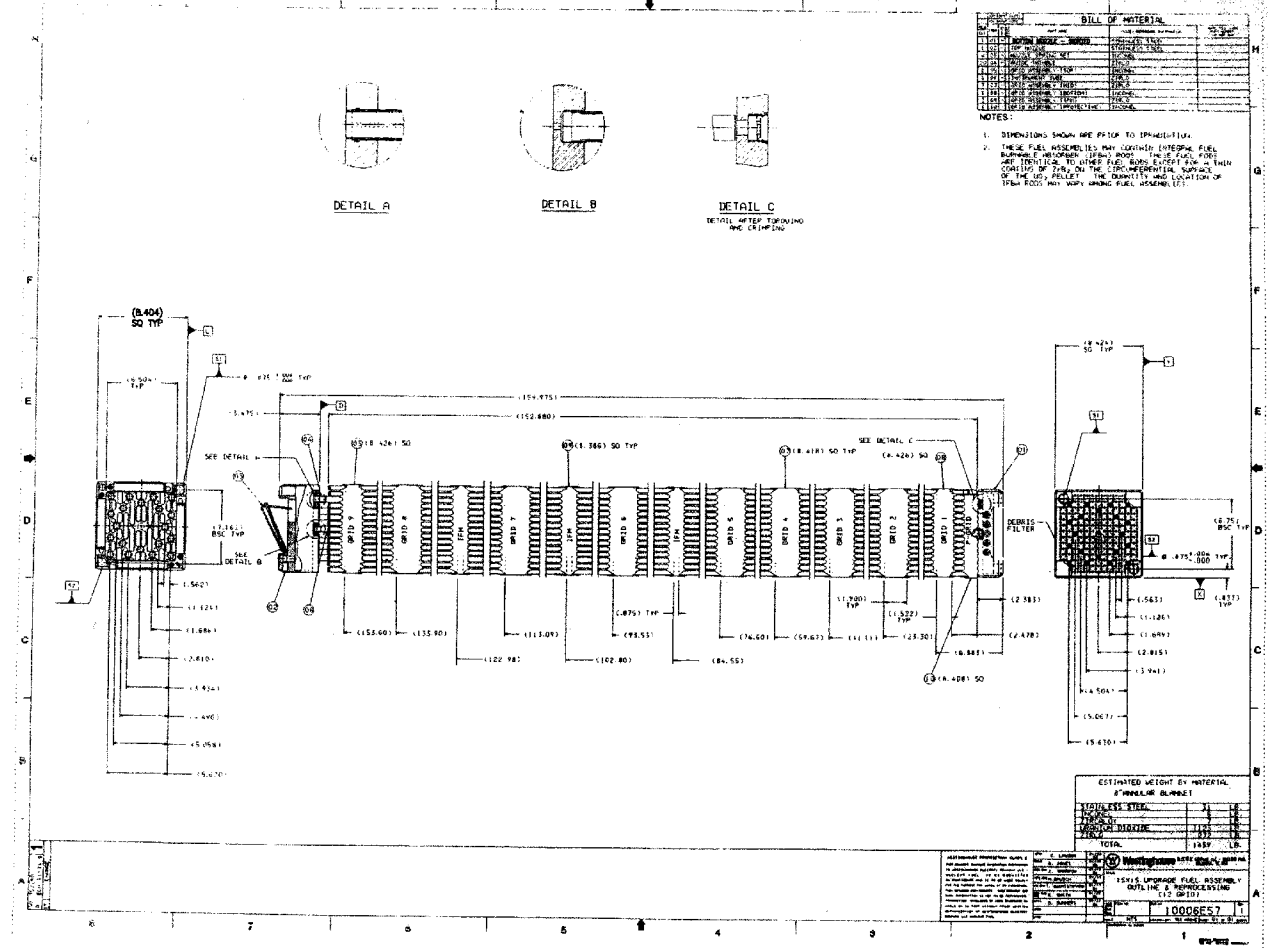

| BILL OF MATERIAL | |
|------------------|--------------------------------|
| ITEM NO. | DESCRIPTION |
| 1 | 15 X 15 UPGRADED FUEL ASSEMBLY |
| 2 | FUEL ROD |
| 3 | CONTROL ROD |
| 4 | ABSORBER ROD |
| 5 | SPRING |
| 6 | WASHER |
| 7 | NUT |
| 8 | PLATE |
| 9 | WASHER |
| 10 | NUT |
| 11 | PLATE |
| 12 | WASHER |
| 13 | NUT |
| 14 | PLATE |
| 15 | WASHER |
| 16 | NUT |
| 17 | PLATE |
| 18 | WASHER |
| 19 | NUT |
| 20 | PLATE |
| 21 | WASHER |
| 22 | NUT |
| 23 | PLATE |
| 24 | WASHER |
| 25 | NUT |
| 26 | PLATE |
| 27 | WASHER |
| 28 | NUT |
| 29 | PLATE |
| 30 | WASHER |
| 31 | NUT |
| 32 | PLATE |
| 33 | WASHER |
| 34 | NUT |
| 35 | PLATE |
| 36 | WASHER |
| 37 | NUT |
| 38 | PLATE |
| 39 | WASHER |
| 40 | NUT |
| 41 | PLATE |
| 42 | WASHER |
| 43 | NUT |
| 44 | PLATE |
| 45 | WASHER |
| 46 | NUT |
| 47 | PLATE |
| 48 | WASHER |
| 49 | NUT |
| 50 | PLATE |

NOTES:
 1. DIMENSIONS SHOWN ARE PRIOR TO SPREAD-FLAT.
 2. THESE FUEL ASSEMBLIES MAY CONTAIN INTERMEDIATE BURNUP FUEL RODS. THESE FUEL RODS ARE IDENTICAL TO OTHER FUEL RODS EXCEPT FOR A THIN COATING OF ZIRCONIUM ON THE TEMPERATURE SURFACE OF THE UO₂ PELLETS. THE QUANTITY AND LOCATION OF THESE RODS MAY VARY AMONG FUEL ASSEMBLIES.

| ESTIMATED WEIGHT BY MATERIAL | |
|------------------------------|--------------|
| MATERIAL | WEIGHT (LBS) |
| STAINLESS STEEL | 1.1 |
| ZIRCONIUM | 1.1 |
| UO ₂ | 1.1 |
| OTHER | 1.1 |
| TOTAL | 4.4 |

15 X 15 UPGRADED FUEL ASSEMBLY
 OUTLINE & DIMENSIONS
 (12 OF 10)
 1000657
 1000657

INDIAN POINT UNIT No. 2

15 X 15 UPGRADED FUEL ASSEMBLY

UFSAR FIGURE 3.2-61C REV. No. 19

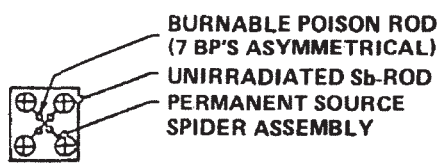
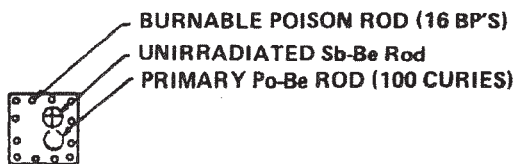
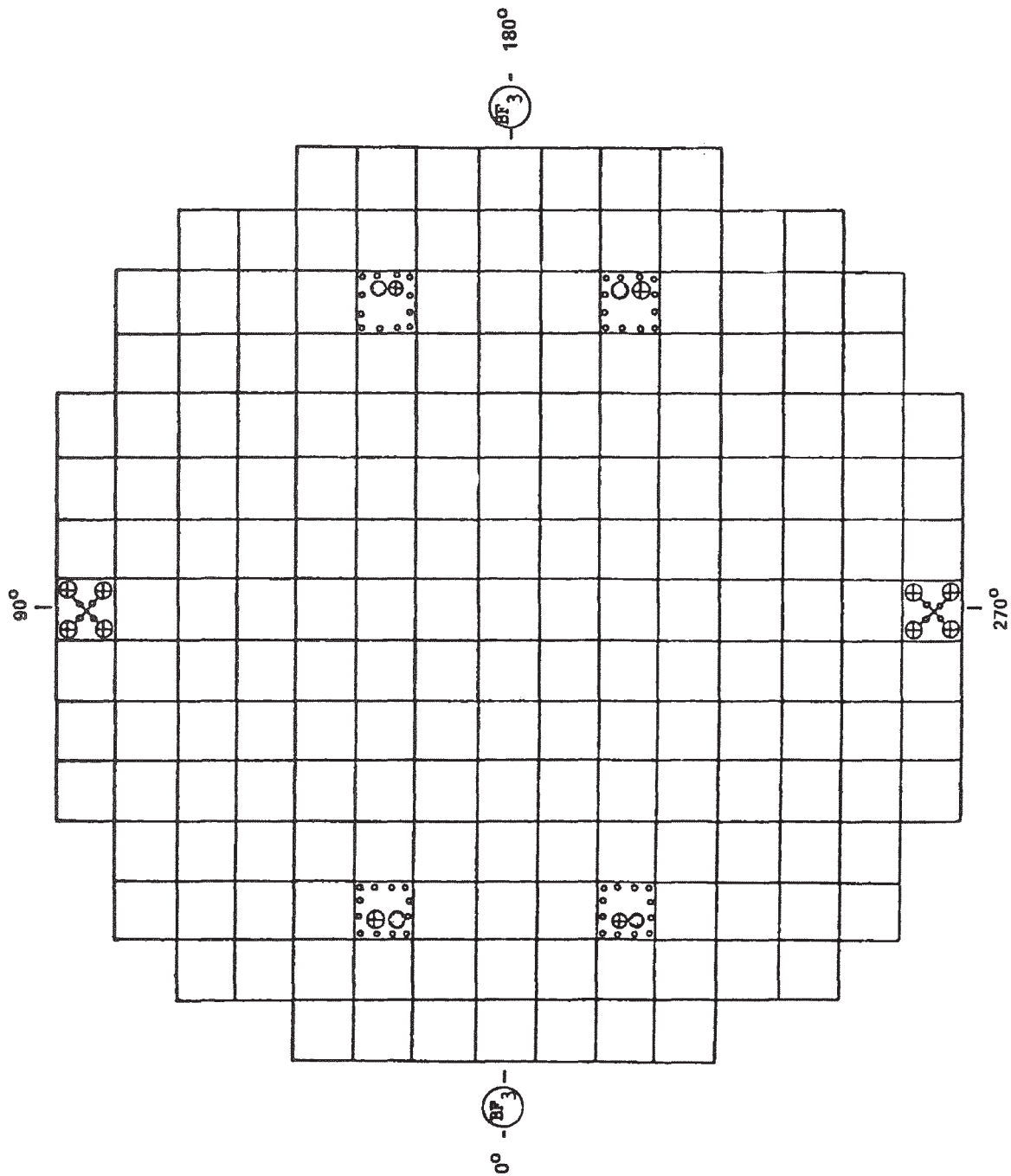

INDIAN POINT UNIT No. 2

UFSAR FIGURE 3.2-62

CYCLE 1 -
NEUTRON SOURCE LOCATIONS

MIC. No. 1999MC3721

REV. No. 17A

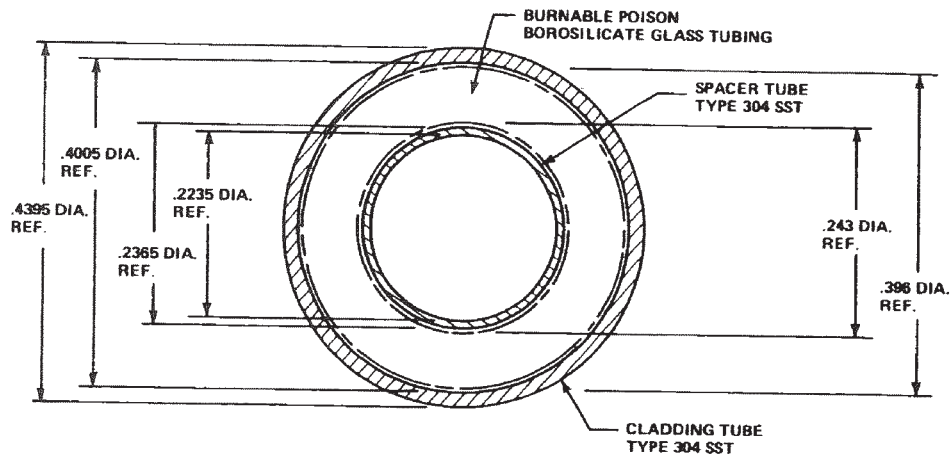

SECTION A-A
SCALE 10:1

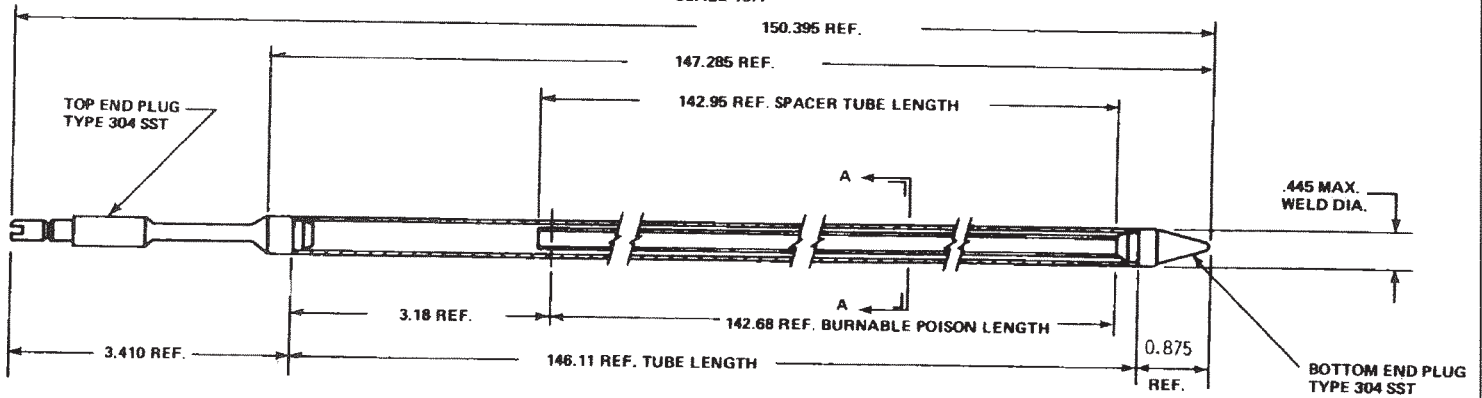

Note: Dimensions are expressed
in inches.

INDIAN POINT UNIT No. 2

UFSAR FIGURE 3.2-63

HIPAR BURNABLE
POISON ROD

MIC. No. 1999MC3722

REV. No. 17A

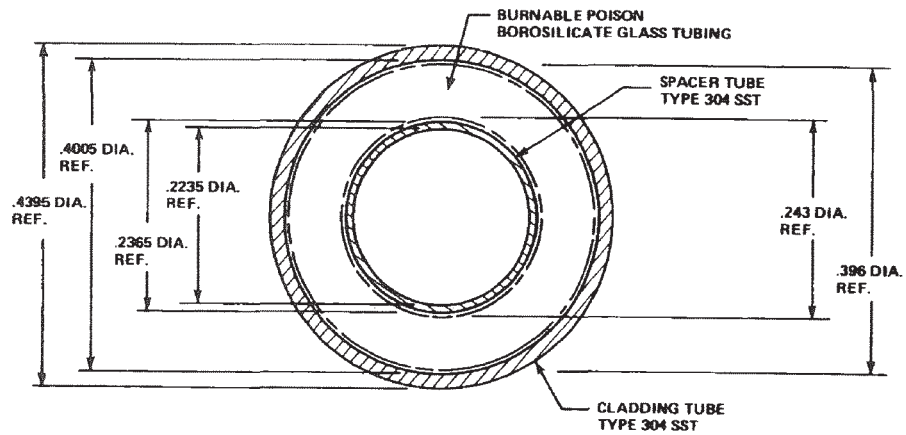

SECTION A-A
SCALE 10:1

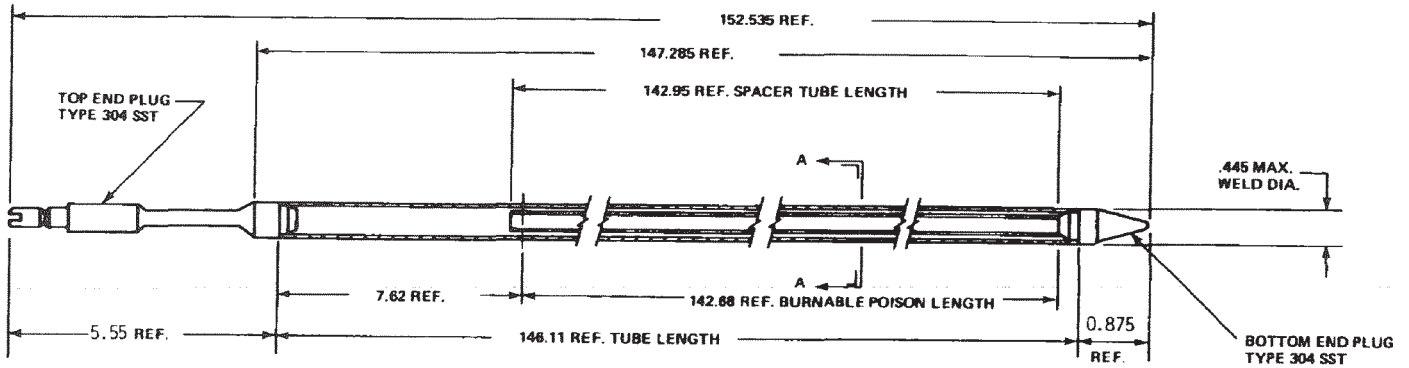

Note: Dimensions are expressed
in inches.

INDIAN POINT UNIT No. 2

UFSAR FIGURE 3.2-64

LOPAR BURNABLE
POISON ROD

MIC. No. 1999MC3723

REV. No. 17A

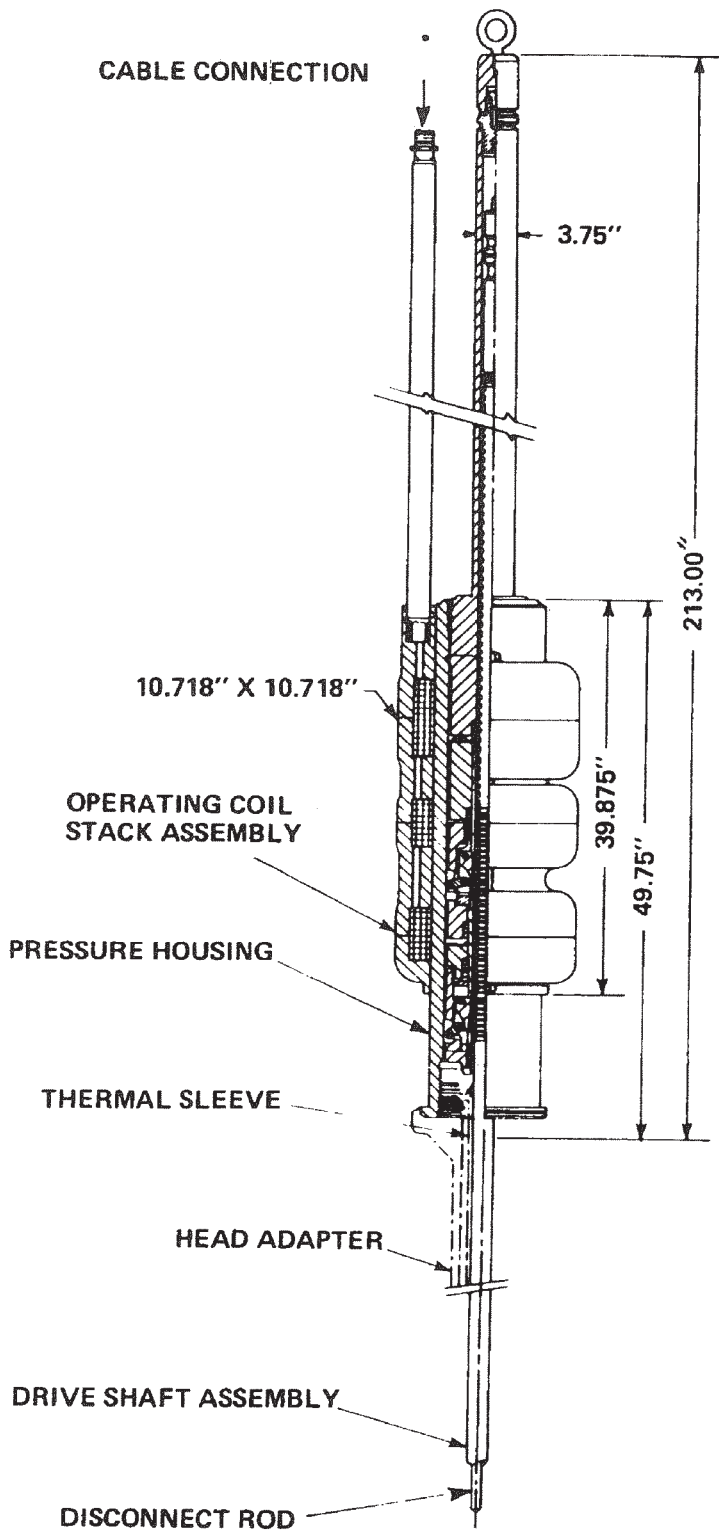

INDIAN POINT UNIT No. 2

UFSAR FIGURE 3.2-65

CONTROL ROD DRIVE
MECHANISM ASSEMBLY

MIC. No. 1999MC3724

REV. No. 17A

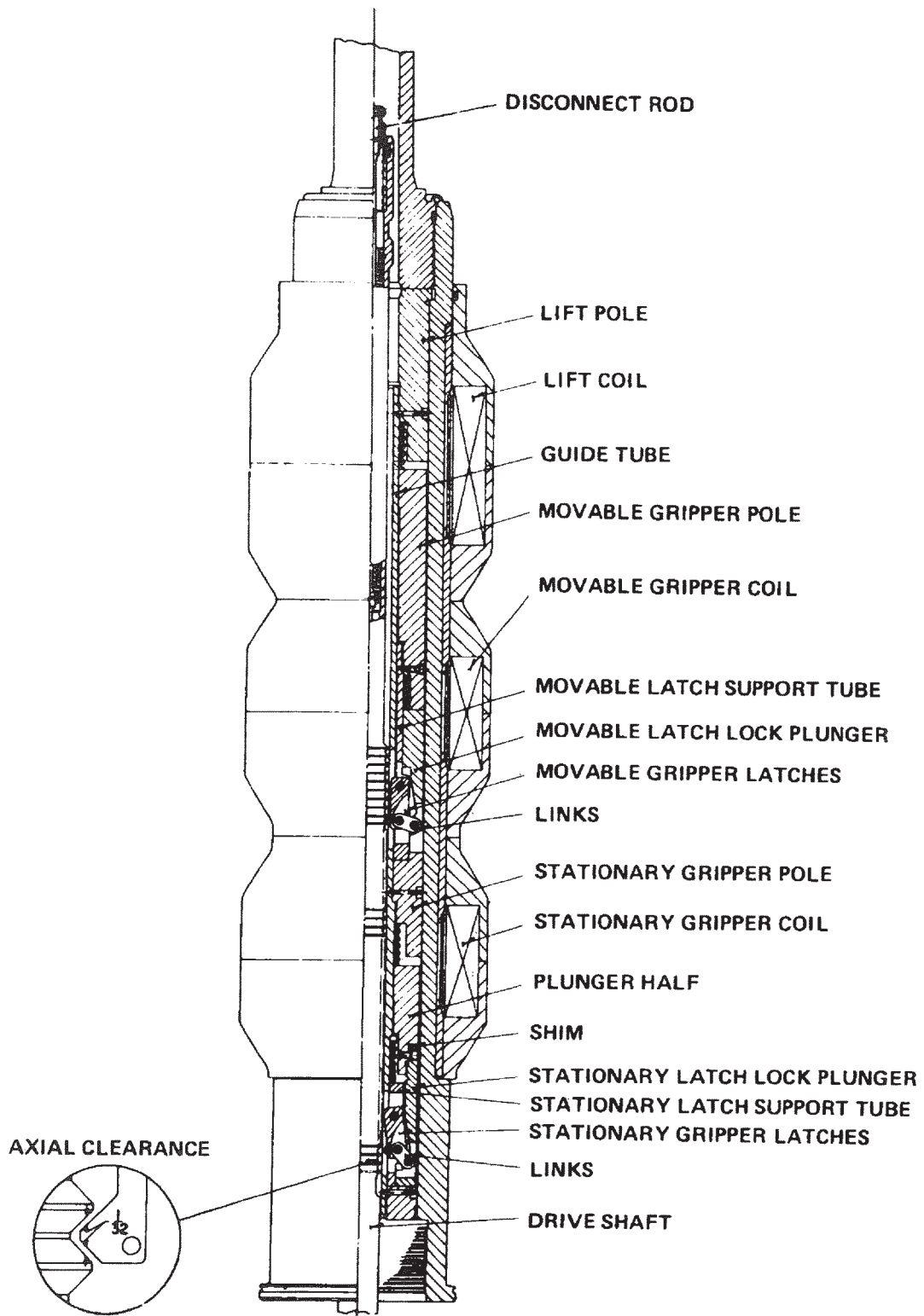

INDIAN POINT UNIT No. 2

UFSAR FIGURE 3.2-66

CONTROL ROD DRIVE
MECHANISM SCHEMATIC

MIC. No. 1999MC3725

REV. No. 17A

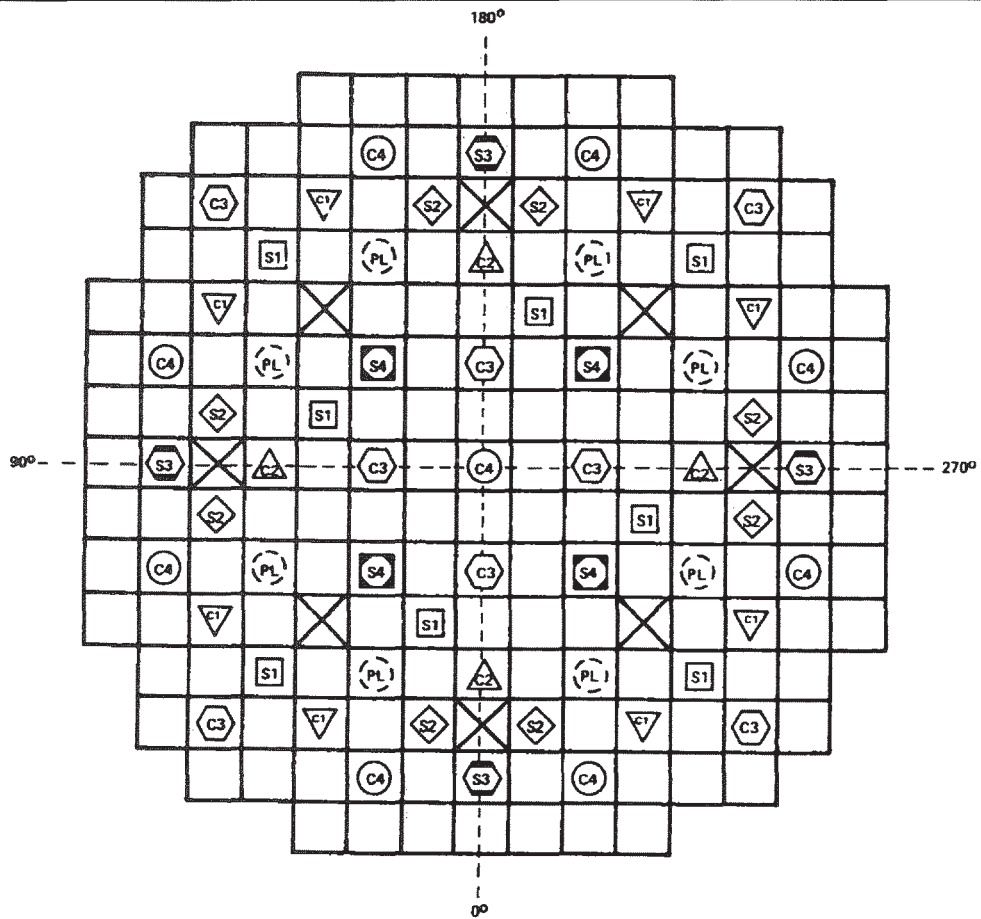

ROD CLUSTER CONTROL BANKS

| BANK | SYMBOL |
|--------------------|--------|
| S1 | □ |
| S2 | ◇ |
| S3 | ⬡ |
| S4 | □ |
| C1 | ▽ |
| C2 | △ |
| C3 | ⬡ |
| C4 | ○ |
| PL | ⊖ |
| (PART-LENGTH ROD)* | |
| FIXED INCORE | × |

Note: Part-length rods have been removed since the original design.

INDIAN POINT UNIT No. 2

UFSAR FIGURE 3.2-67

THIMBLE LOCATIONS -
FIXED INCORE DETECTORS

MIC. No. 1999MC3726

REV. No. 17A

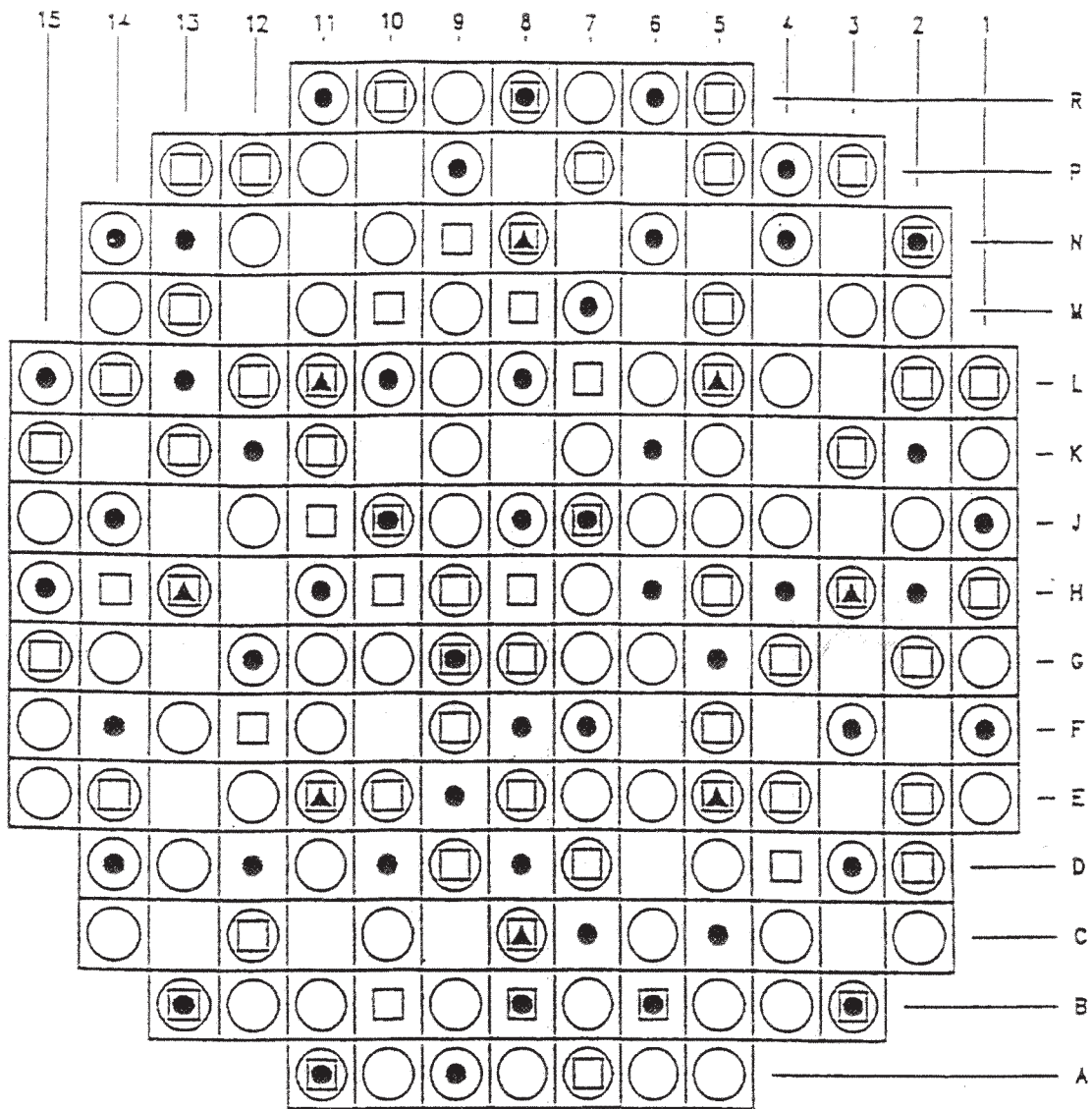

270°

- THERMOCOUPLE LOCATION..... 65
- MOVABLE DETECTOR LOCATION.... 50
- FLOW MIXING DEVICE LOCATION.. 132
- FIXED DETECTOR LOCATION..... 8

INDIAN POINT UNIT No. 2

**INCORE DETECTOR,
THERMOCOUPLE AND FLOW
MIXING DEVICE LOCATIONS**

UFSAR FIGURE 3.2-68 | REV. No. 19

FIGURE 2
 INDIAN POINT UNIT 2, CYCLE 23
 CORE COMPONENTS AND FRESH INTEGRAL BA LOCATIONS

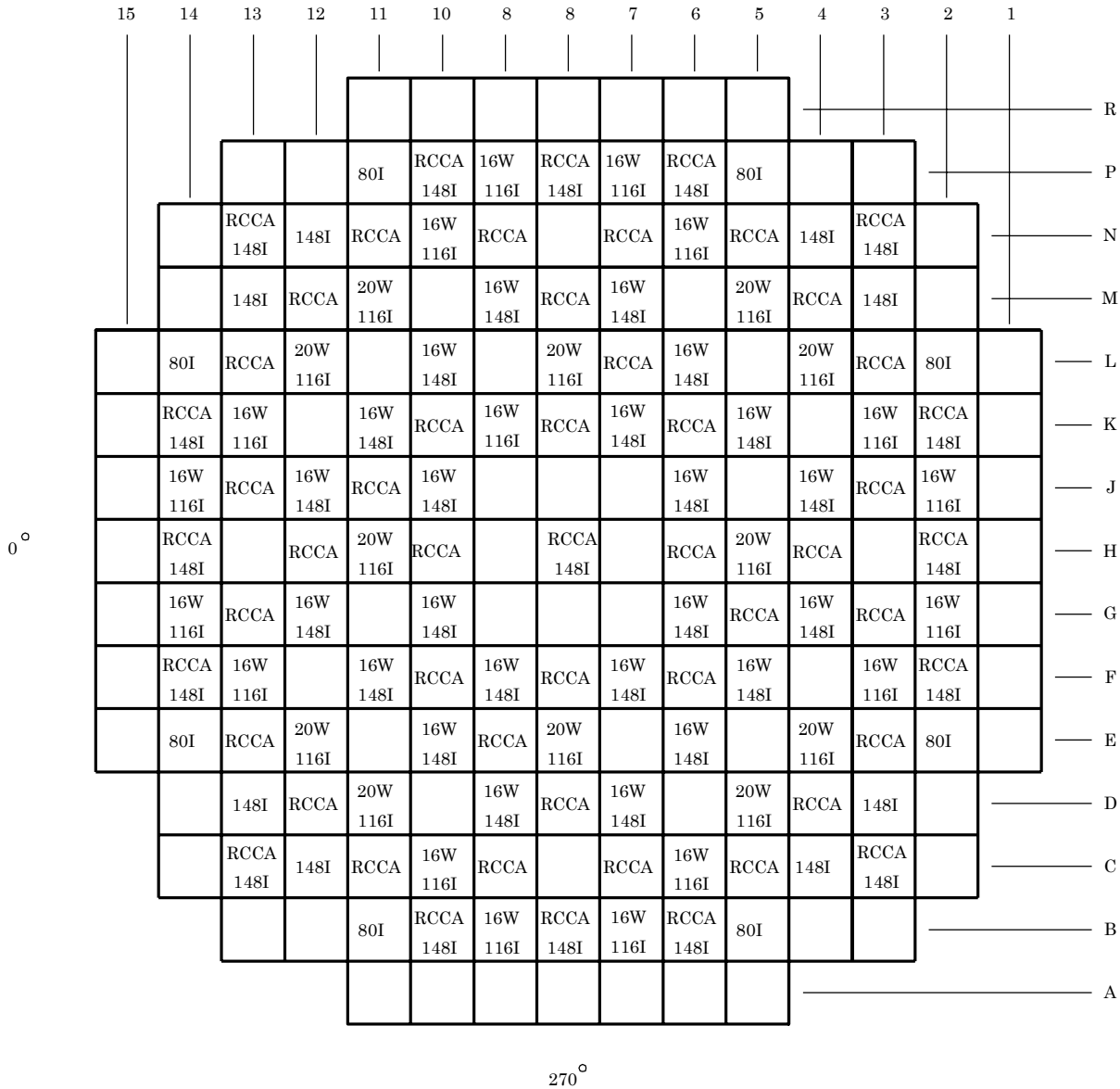

LEGEND

TYPE COMPONENT TYPE
 ### NUMBER OF FRESH IFBA RODS

CORE COMPONENT TYPES

RCCA—CONTROL OR SHUTDOWN
 ## W—NUMBER OF RODLETS ON WABA ASSEMBLY

Fuel Assembly Orientation







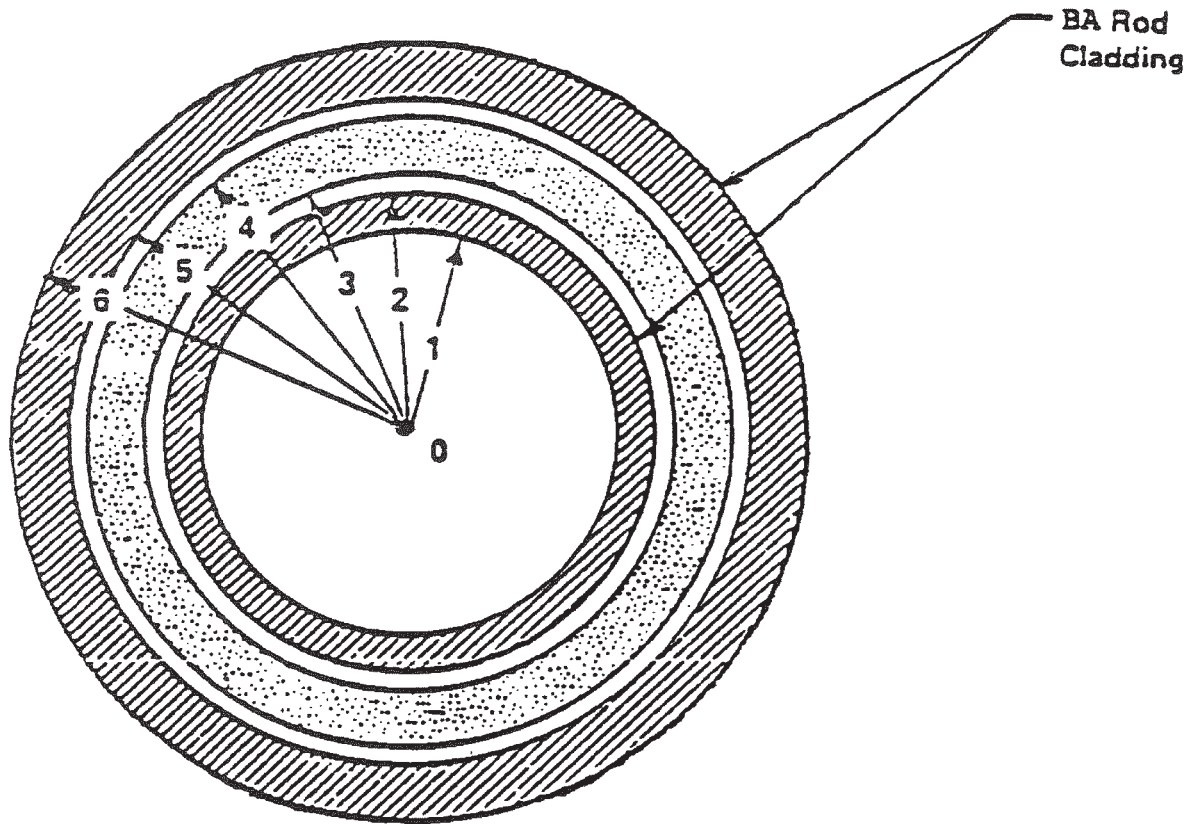

- Reference Hole
- Core Pin Hole
- ∖ Hold Down Bar

NOTE: Figures are Top View
 Component Orientation Shown in Table 2

| | |
|---|-------------|
| INDIAN POINT UNIT No. 2 | |
| CYCLE 23 REGION AND FUEL ASSEMBLY LOCATIONS | |
| UFSAR FIGURE 3.2-68A | REV. No. 26 |



Zone Number Previous Design BA WABA Design

| | | | |
|---|-----|--------------------|----------------------|
|  | 0-1 | Air | Water |
|  | 1-2 | Stainless steel | Zircaloy |
|  | 2-3 | Air | Helium |
|  | 3-4 | Borosilicate glass | $Al_2O_3 \cdot B_4C$ |
|  | 4-5 | Air | Helium |
|  | 5-6 | Stainless steel | Zircaloy |

INDIAN POINT UNIT No. 2

UFSAR FIGURE 3.2-69

COMPARISON OF BOROSILICATE GLASS
ABSORBER ROD WITH WABA ROD

MIC. No. 1999MC3730

REV. No. 17A

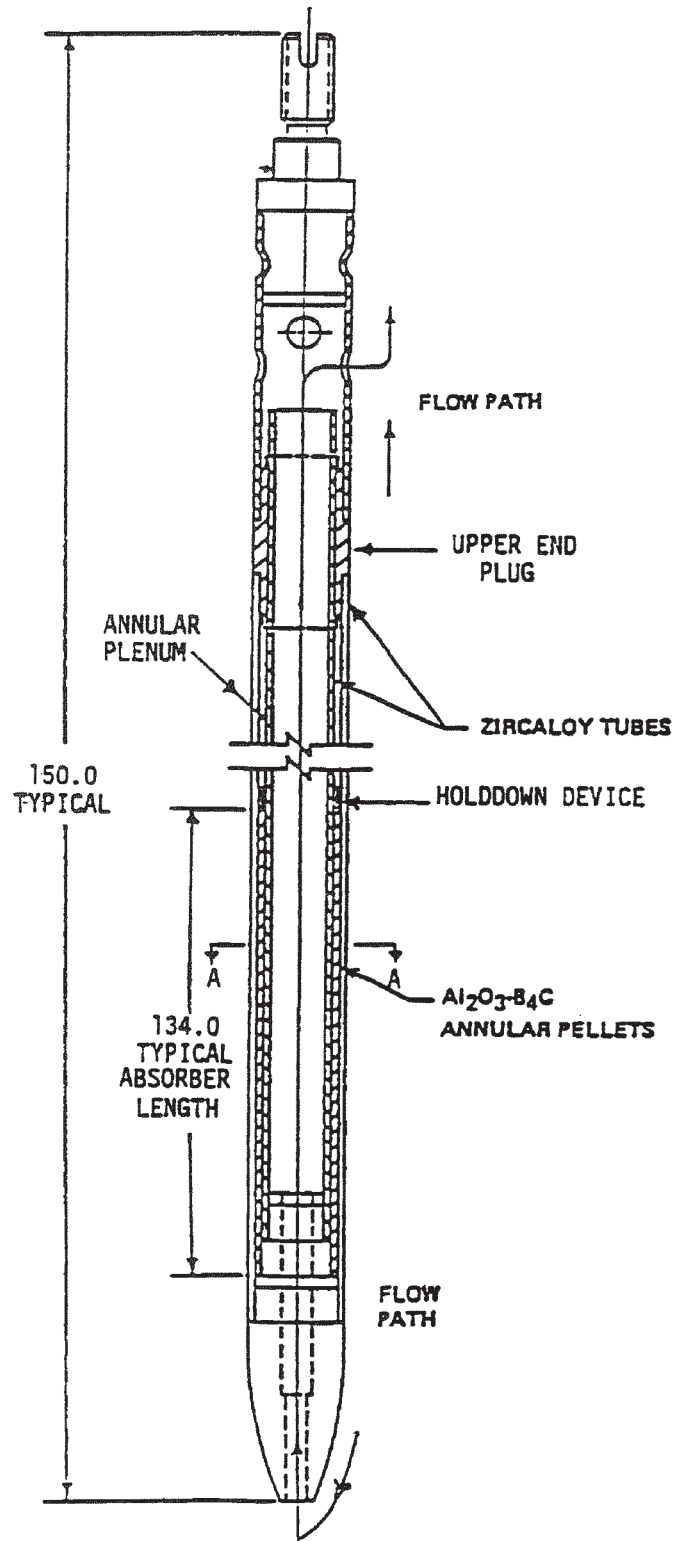

INDIAN POINT UNIT No. 2

UFSAR FIGURE 3.2-70

WET ANNULAR BURNABLE
ABSORBER ROD

MIC. No. 1999MC3732

REV. No. 17A