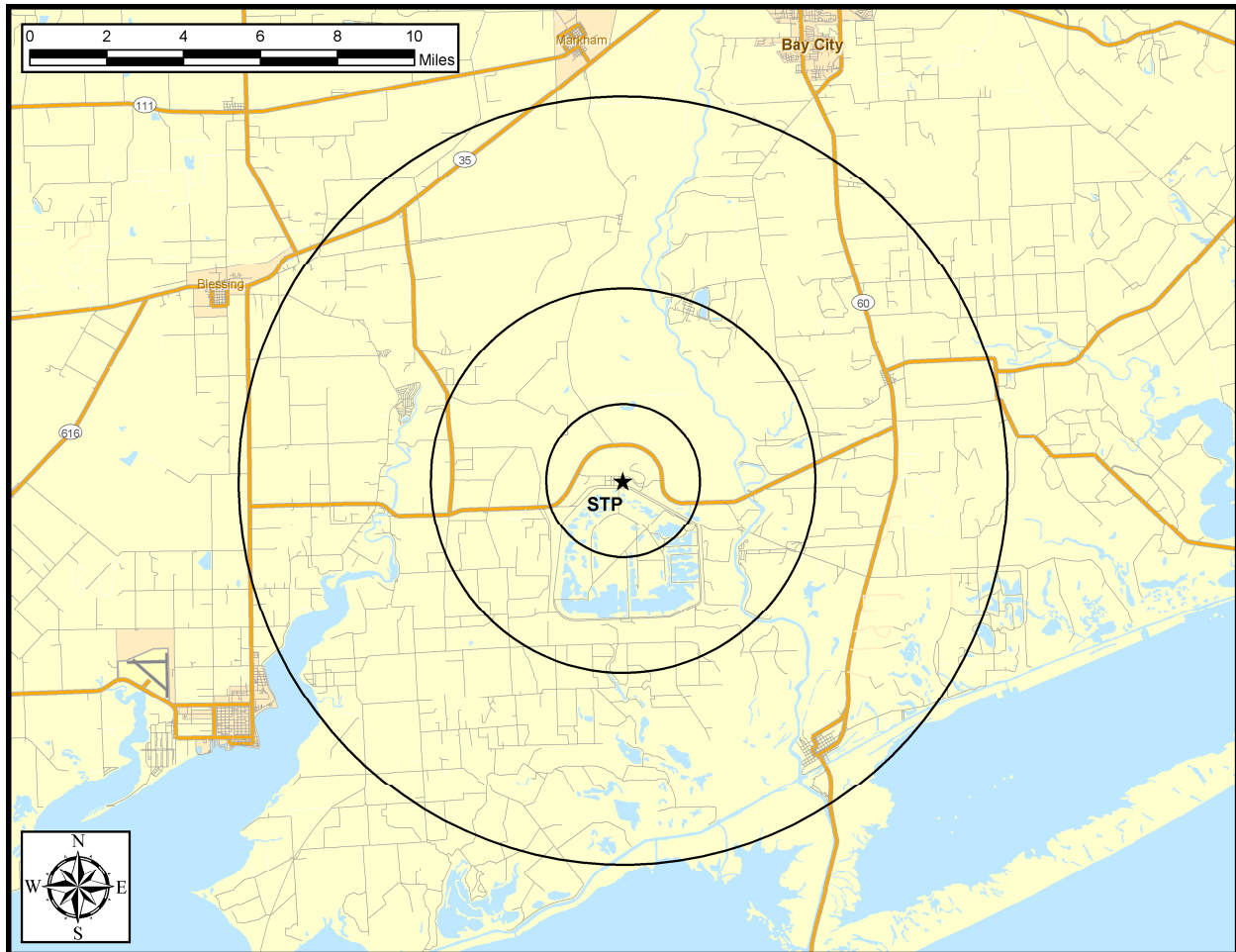


**South Texas Project**

**Development of Evacuation Time Estimates**



**Prepared for:**

**South Texas Project Nuclear Operating Company**

**by:**

**KLD Associates, Inc.**  
**43 Corporate Drive**  
**Hauppauge, NY 11788**  
[\*\*kweinisch@kldassociates.com\*\*](mailto:kweinisch@kldassociates.com)

## TABLE OF CONTENTS

<u>Section</u>	<u>Title</u>	<u>Page</u>
	Executive Summary.....	ES-1
1.	INTRODUCTION .....	1-1
1.1	Overview of ETE the Update Process.....	1-1
1.2	The South Texas Project Site Location .....	1-3
1.3	Preliminary Activities.....	1-5
1.4	Comparison with Prior ETE Study.....	1-9
2.	STUDY ESTIMATES AND ASSUMPTIONS .....	2-1
2.1	Data Estimates .....	2-1
2.2	Study Methodological Assumptions .....	2-2
2.3	Study Assumptions .....	2-5
3.	DEMAND ESTIMATION.....	3-1
4.	ESTIMATION OF HIGHWAY CAPACITY.....	4-1
5.	ESTIMATION OF TRIP GENERATION TIME .....	5-1
6.	DEMAND ESTIMATION FOR EVACUATION SCENARIOS.....	6-1
7.	GENERAL POPULATION EVACUATION TIME ESTIMATES (ETE).....	7-1
7.1	Voluntary Evacuation and Shadow Evacuation.....	7-1
7.2	Patterns of Traffic Congestion during Evacuation.....	7-2
7.3	Evacuation Rates.....	7-3
7.4	Guidance on Using ETE Tables .....	7-4
8.	TRANSIT-DEPENDENT AND SPECIAL FACILITY EVACUATION TIME ESTIMATES .....	8-1
8.1	Transit-Dependent People-Demand Estimate .....	8-2
8.2	School Population-Transit Demand.....	8-3
8.3	Evacuation Time Estimates for Transit-Dependent People .....	8-4
9.	TRAFFIC MANAGEMENT STRATEGY .....	9-1
10.	EVACUATION ROUTES .....	10-1
11.	SURVEILLANCE OF EVACUATION OPERATIONS .....	11-1
12.	CONFIRMATION TIME .....	12-1
13	RECOMMENDATIONS AND CONCLUSIONS .....	13-1

## LIST OF APPENDICES

Appendix A .....	Glossary of Traffic Engineering Terms
Appendix B .....	Traffic Assignment Model
Appendix C .....	Traffic Simulation Model: PC-DYNEV
Appendix D .....	Detailed Description of Study Procedure
Appendix E .....	Special Facility Data
Appendix F .....	Telephone Survey
Appendix G .....	Traffic Control
Appendix H .....	Evacuation Regions
Appendix I .....	Evacuation Sensitivity Studies
Appendix J .....	Evacuation Time Estimates For All Evacuation Regions and Scenarios and Evacuation Time Graphs for Region R03, For All Scenarios
Appendix K .....	Evacuation Roadway Network Characteristics
Appendix L .....	Zone Boundaries

## LIST OF FIGURES

<u>Number</u>	<u>Title</u>	<u>Page</u>
1-1	Location of South Texas Project -----	1-4
1-2	STP Link-Node Network-----	1-8
2-1	Voluntary Evacuation Methodology -----	2-4
3-1	STP EPZ and Zones -----	3-3
3-2	Permanent Residents by Sector -----	3-6
3-3	Permanent Resident Vehicles by Sector-----	3-7
3-4	Transient Population by Sector-----	3-11
3-5	Transient Vehicles by Sector-----	3-12
3-6	Non-Resident Employee Population by Sector -----	3-15
3-7	Non-Resident Employee Vehicles by Sector -----	3-16
4-1	Fundamental Relationship Between Volume and Density -----	4-4
5-1	Events and Activities Preceding the Evacuation Trip-----	5-5
5-2	Evacuation Mobilization Activities-----	5-10
5-3	Comparison of Trip Generation Distributions -----	5-13
6-1	STP EPZ Zones -----	6-2
7-1	Voluntary Evacuation Methodology -----	7-12
7-2	STP Shadow Evacuation Region -----	7-13
7-3	Traffic Congestion at 45 Minutes after the Advisory to Evacuate -----	7-14
7-4	Traffic Congestion at 1 Hour and 15 Minutes after the Advisory to Evacuate -----	7-15
7-5	Evacuation Time Estimates for STP Summer, Weekend, Midday, Good Weather Evacuation of Region R03 (Entire EPZ) -----	7-16
8-1	Chronology of Transit Evacuation Operations-----	8-10

**LIST OF FIGURES (Cont.)**

<b><u>Number</u></b>	<b><u>Title</u></b>	<b><u>Page</u></b>
8-2	Proposed Transit Dependent Bus Routes-----	8-16
10-1	General Population Reception Centers-----	10-2
10-2	Evacuation Route Map (All Zones)-----	10-3
C-1	Representative Analysis Network-----	C-5
D-1	Flow Diagram of Activities-----	D-4
E-1	Schools and Major Employers in STP EPZ-----	E-3
E-2	Recreational Areas in STP EPZ-----	E-5
E-3	Lodging Facilities in STP EPZ-----	E-7
F-1	Household Size in the EPZ-----	F-3
F-2	Household Vehicle Availability-----	F-4
F-3	Vehicle Availability – 1 to 4 Person Households-----	F-5
F-4	Vehicle Availability – 5 to 8 Person Households-----	F-5
F-5	School Children in Households-----	F-6
F-6	Commuters in Households in the EPZ-----	F-6
F-7	Modes of Travel in the EPZ-----	F-7
F-8	Number of Vehicles Used for Evacuation-----	F-8
F-9	Time Required to Prepare to Leave Work/School-----	F-8
F-10	Work to Home Travel Time-----	F-9
F-11	Time to Prepare Home for Evacuation-----	F-10
G-1	Traffic Control Points-----	G-2
H-1	Region R01-----	H-3
H-2	Region R02-----	H-4
H-3	Region R03-----	H-5
H-4	Region R04-----	H-6
H-5	Region R05-----	H-7
H-6	Region R06-----	H-8
H-7	Region R07-----	H-9
H-8	Region R08-----	H-10

**LIST OF FIGURES (Cont.)**

<b><u>Number</u></b>	<b><u>Title</u></b>	<b><u>Page</u></b>
H-9	Region R09 -----	H-11
H-10	Region R10 -----	H-12
H-11	Region R11 -----	H-13
H-12	Region R12 -----	H-14
H-13	Region R13 -----	H-15
H-14	Region R14 -----	H-16
H-15	Region R15 -----	H-17
H-16	Region R16 -----	H-18
H-17	Region R17 -----	H-19
H-18	Region R18 -----	H-20
H-19	Region R19 -----	H-21
H-20	Region R20 -----	H-22
H-21	Region R21 -----	H-23
H-22	Region R22 -----	H-24
J-1	Evacuation Time Estimates Scenario 1 for Region R03 (Entire EPZ) -----	J-9
J-2	Evacuation Time Estimates Scenario 2 for Region R03 (Entire EPZ) -----	J-10
J-3	Evacuation Time Estimates Scenario 3 for Region R03 (Entire EPZ) -----	J-11
J-4	Evacuation Time Estimates Scenario 4 for Region R03 (Entire EPZ) -----	J-12
J-5	Evacuation Time Estimates Scenario 5 for Region R03 (Entire EPZ) -----	J-13
J-6	Evacuation Time Estimates Scenario 6 for Region R03 (Entire EPZ) -----	J-14
J-7	Evacuation Time Estimates Scenario 7 for Region R03 (Entire EPZ) -----	J-15
J-8	Evacuation Time Estimates Scenario 8 for Region R03 (Entire EPZ) -----	J-16
J-9	Evacuation Time Estimates Scenario 9 for Region R03 (Entire EPZ) -----	J-17
J-10	Evacuation Time Estimates Scenario 10 for Region R03 (Entire EPZ) -----	J-18
J-11	Evacuation Time Estimates Scenario 11 for Region R03 (Entire EPZ) -----	J-19
J-12	Evacuation Time Estimates Scenario 12 for Region R03 (Entire EPZ) -----	J-20

**LIST OF FIGURES (Cont.)**

<b><u>Number</u></b>	<b><u>Title</u></b>	<b><u>Page</u></b>
K-1	STP Site Link-Node Analysis Network -----	K-2
K-2	STP Site Link-Node Analysis Network Inset 1-----	K-3
K-3	STP Site Link-Node Analysis Network Inset 2-----	K-4
K-4	STP Site Link-Node Analysis Network Inset 3-----	K-5
K-5	STP Site Link-Node Analysis Network Inset 4-----	K-6
K-6	STP Site Link-Node Analysis Network Inset 5-----	K-7
K-7	STP Site Link-Node Analysis Network Inset 6-----	K-8
K-8	STP Site Link-Node Analysis Network Inset 7-----	K-9
K-9	STP Site Link-Node Analysis Network Inset 8-----	K-10
K-10	STP Site Link-Node Analysis Network Inset 9-----	K-11
K-11	STP Site Link-Node Analysis Network Inset 10-----	K-12
K-12	STP Site Link-Node Analysis Network Inset 11-----	K-13
K-13	STP Site Link-Node Analysis Network Inset 12-----	K-14
K-14	STP Site Link-Node Analysis Network Inset 13-----	K-15
K-15	STP Site Link-Node Analysis Network Inset 14-----	K-16
K-16	STP Site Link-Node Analysis Network Inset 15-----	K-17
K-17	STP Site Link-Node Analysis Network Inset 16-----	K-18
K-18	STP Site Link-Node Analysis Network Inset 17-----	K-19
K-19	STP Site Link-Node Analysis Network Inset 18-----	K-20
K-20	STP Site Link-Node Analysis Network Inset 19-----	K-21
K-21	STP Site Link-Node Analysis Network Inset 20-----	K-22

## LIST OF TABLES

<u>Number</u>	<u>Title</u>	<u>Page</u>
1-1	ETE Study Comparisons-----	1-10
3-1	EPZ Permanent Resident Population-----	3-4
3-2	Permanent Resident Population and Vehicles by Zone-----	3-5
3-3	Summary of Transients by Zone-----	3-10
3-4	Summary of Non-EPZ Employees by Zone-----	3-14
5-1	Event Sequence for Evacuation Activities-----	5-3
5-2	Time Distribution for Notifying the Public-----	5-6
5-3	Time Distribution for Employees to Prepare to Leave Work-----	5-7
5-4	Time Distribution for Commuters to Travel Home-----	5-8
5-5	Time Distribution for Population to Prepare to Evacuate-----	5-9
5-6	Mapping Distributions to Events-----	5-11
5-7	Description of the Distributions-----	5-12
5-8	Trip Generation for the EPZ Population-----	5-14
6-1	Definition of Evacuation Regions-----	6-3
6-2	Description of Evacuation Regions-----	6-4
6-3	Evacuation Scenario Definitions-----	6-5
6-4	Percent of Population Groups Evacuating for Various Scenarios-----	6-6
6-5	Vehicle Estimates by Scenario-----	6-7
7-1A	Time to Clear the Indicated Area of 50 Percent of the Affected Population-----	7-7
7-1B	Time To Clear the Indicated Area of 90 Percent of the Affected Population-----	7-8
7-1C	Time to Clear the Indicated Area of 95 Percent of the Affected Population-----	7-9
7-1D	Time to Clear the Indicated Area of 100 Percent of the Affected Population-----	7-10
7-2	Description of Evacuation Regions-----	7-11



**LIST OF TABLES (Cont.)**

<b><u>Number</u></b>	<b><u>Title</u></b>	<b><u>Page</u></b>
8-1	Transit Dependent Population Estimates-----	8-11
8-2	School Population Demand Estimates -----	8-12
8-3	School Relocation Schools -----	8-12
8-4	Bus Route Descriptions -----	8-13
8-5A	School Evacuation Time Estimates – Good Weather -----	8-14
8-5B	School Evacuation Time Estimates – Rain-----	8-14
8-6	Summary of Transit Dependent Bus Routes -----	8-15
8-7A	Transit-Dependent Evacuation Time Estimates – Good Weather -----	8-17
8-7B	Transit-Dependent Evacuation Time Estimates – Rain-----	8-17
12-1	Estimated Number of Telephone Calls Required for Confirmation of Evacuation-----	12-2
C-1	Measures of Effectiveness Output by PC-DYNEV -----	C-3
C-2	Input Requirements for the PC-DYNEV Model-----	C-4
E-1	Schools within the STP EPZ (As of March 2007)-----	E-2
E-2	Major Employers within the STP EPZ (As of March 2007)-----	E-2
E-3	Recreational Areas within the STP EPZ (As of March 2007)-----	E-4
E-4	Lodging Facilities within the STP EPZ (As of March 2007) -----	E-6
F-1	STP Telephone Survey Sampling Plan -----	F-2
G-1	Traffic Control Points-----	G-3
H-1	Percent of Zone Population Evacuating for Each Region -----	H-2
I-1	Evacuation Time Estimates for Trip Generation Sensitivity Study -----	I-1
I-2	Evacuation Time Estimates for Shadow Sensitivity Study -----	I-2
J-1A	Time to Clear Indicated Area of 50 Percent of the Affected Population -----	J-4
J-1B	Time to Clear Indicated Area of 90 Percent of the Affected Population -----	J-5
J-1C	Time to Clear Indicated Area of 95 Percent of the Affected Population -----	J-6
J-1D	Time to Clear Indicated Area of 100 Percent of the Affected Population-----	J-7
J-2	Description of Evacuation Regions-----	J-8
K-1	Evacuation Roadway Network Characteristics-----	K-23

## EXECUTIVE SUMMARY

This report describes the analyses undertaken and the results obtained by a study to develop Evacuation Time Estimates (ETE) for the South Texas Project (STP) located in Matagorda County, Texas. Evacuation time estimates provide State and local governments with site-specific information needed for Protective Action decision-making.

In the performance of this effort, all available prior documentation relevant to Evacuation Time Estimates was reviewed. Other guidance is provided by documents published by Federal Government agencies. Most important of these are:

- Criteria for Preparation and Evaluation of Radiological Emergency Response Plans and Preparedness in Support of Nuclear Power Plants, NUREG-0654/FEMA-REP-1, Rev. 2, November 1980.
- Analysis of Techniques for Estimating Evacuation Times for Emergency Planning Zones, NUREG/CR-1745, November 1980.
- Development of Evacuation Time Estimates for Nuclear Power Plants, NUREG/CR-6863, January 2005.

### Overview of Project Activities

This project began in January, 2007 and extended over a period of 9 months. The major activities performed are briefly described in chronological sequence:

- Attended “kick-off” meetings with South Texas Project personnel and emergency management personnel representing state and local governments.
- Reviewed prior ETE reports prepared for STP and accessed U.S. Census data files for the year 2000. Studied Geographical Information Systems (GIS) maps of the area in the vicinity of STP, then conducted a field survey of the highway network.
- Synthesized this information to create an analysis network representing the highway system topology and capacities within the EPZ, and extending 15 miles radially from STP.
- Designed and sponsored a telephone survey of residents within the EPZ to gather focused data needs for this ETE study that were not contained within the census database. The survey instrument was reviewed and modified by State and county personnel prior to the survey.

- Data collection forms (provided to Matagorda County at the kickoff meeting) were returned with data pertaining to employment, transients, and special facilities within the county.
- The traffic demand and trip-generation rates of evacuating vehicles were estimated from the gathered data. The trip generation rates reflect the estimated mobilization time (i.e., the time required by evacuees to prepare for the evacuation trip) that was computed using the results of the telephone survey of EPZ residents.
- Following Federal guidelines, the EPZ is subdivided into 11 Zones. The Zones are grouped within circular areas or within “keyhole” configurations (circles plus radial sectors) that define a total of 22 Evacuation Regions.
- The Matagorda Beach area has only one access road - FM 2031, which cuts through the STP EPZ. It is prudent to evacuate both the resident and transient population on the beach in the event of an emergency, since an escalation of the event or a change in wind direction could expose those evacuees on FM 2031 to the plume. Thus, it is assumed that in every scenario and for every region these people will be evacuated, and their vehicles will be included in the network traffic.
- The time-varying external circumstances are represented as Evacuation Scenarios, each described in terms of the following factors: (1) Season (Summer, Winter); (2) Day of Week (Midweek, Weekend); (3) Time of Day (Midday, Evening); and (4) Weather (Good, Rain). Two special scenarios involving a summer beach holiday, and the construction of a new unit at the STP site were considered.
- The Planning Basis for the calculation of ETE is:
  - A rapidly escalating accident at STP that quickly assumes the status of General Emergency such that the Advisory to Evacuate is virtually coincident with the siren alert.
  - While an unlikely accident scenario, this planning basis will yield ETE, measured as the elapsed time from the Advisory to Evacuate until the last vehicle exits the impacted Region, that represent “upper bound” estimates. This conservative Planning Basis is applicable for all initiating events.
- If the emergency occurs while schools are in session, the ETE study assumes that the children will be evacuated by bus directly to specified host schools located outside the EPZ. Parents, relatives, and neighbors are advised to pick up their children at the host school for a Site Area Emergency or higher. The ETE for school children are calculated separately.
- Evacuees who do not have access to a private vehicle will either ride-share with relatives, friends or neighbors, or be evacuated by buses provided as specified in the county evacuation plans. Separate ETE are calculated for the transit-dependent evacuees.

## Computation of ETE

A total of 264 ETE were computed for the evacuation of the general public. Each ETE quantifies the aggregate evacuation time estimated for the population within one of the 22 Evacuation Regions to completely evacuate from that Region, under the circumstances defined for one of the 12 Evacuation Scenarios (22 x 12 = 264). Separate ETE are calculated for transit-dependent evacuees, including school children for applicable scenarios.

Except for Region R03, which is the evacuation of the entire EPZ, only a portion of the people within the EPZ would be advised to evacuate. That is, the Advisory to Evacuate would apply only to those people occupying the specified impacted region. It is assumed that 100 percent of the people within the impacted region will evacuate in response to this Advisory. The people occupying the remainder of the EPZ outside the impacted region may be advised to take shelter.

The computation of ETE assumes that a portion of the population within the EPZ but outside the impacted region, will elect to “voluntarily” evacuate. These voluntary evacuees could impede those others who are evacuating from within the impacted region. The impedance that could be caused by voluntary evacuees is considered in the computation of ETE for the impacted region. In addition, impedance caused by voluntary evacuees originating their trips in the “shadow region” outside the EPZ and extending to a radial distance of 15 miles from STP, is likewise considered.

The computational procedure is outlined as follows:

- A link-node representation of the highway network is coded. Each link represents a unidirectional length of highway; each node usually represents an intersection or merge point. The capacity of each link is estimated based on the field survey observations and on established procedures.
- The evacuation trips are generated at locations called “zonal centroids” located within the EPZ. The trip generation rates vary over time reflecting the mobilization process, and from one location (centroid) to another depending on population density and on whether a centroid is within, or outside, the impacted area.
- The computer models compute the routing patterns for evacuating vehicles that are compliant with federal guidelines (outbound relative to the location of STP), then simulate the traffic flow movements over space and time. This simulation process estimates the rate that traffic flow exits the impacted region.
- The ETE statistics provide the elapsed times for 50 percent, 90 percent, 95 percent, and 100 percent, respectively, of the population within the impacted region, to evacuate from within the impacted region. These statistics are presented in tabular and graphical formats.

## Traffic Management

This study includes the development of a comprehensive traffic management plan designed to expedite the evacuation of people from within an impacted region. The plan takes the form of detailed schematics specifying: (1) the directions of evacuation travel to be facilitated, and other traffic movements to be discouraged; (2) the equipment needed (cones, barricades) and their deployment; (3) the locations of these “Traffic Control Points” (TCP); and (4) the number of traffic control personnel required.

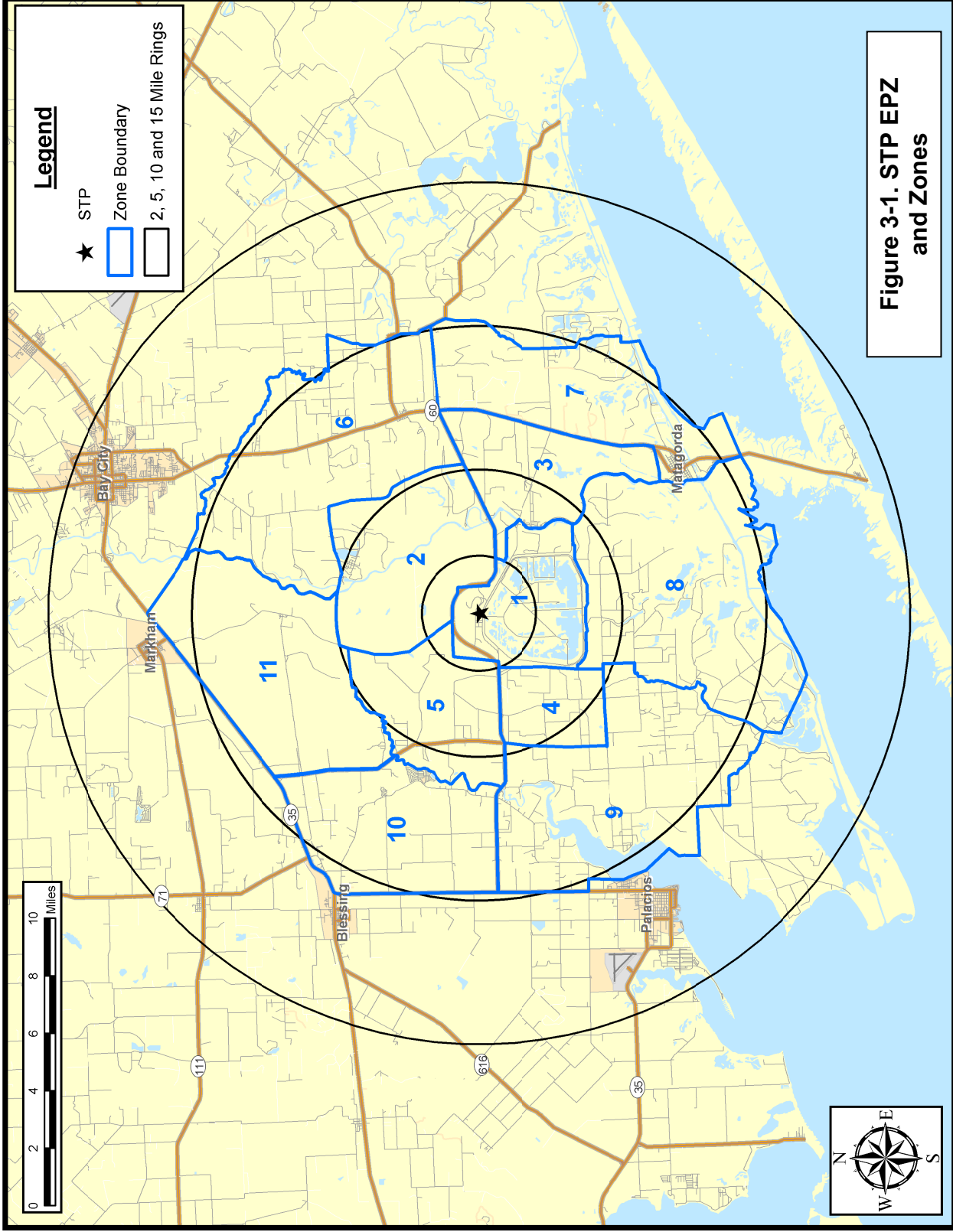
## Selected Results

A compilation of selected information is presented on the following pages in the form of Figures and Tables extracted from the body of the report; these are described below.

- Figure 3-1 displays a map of the STP site showing the layout of the 11 Zones that comprise, in aggregate, the Emergency Planning Zone (EPZ).
- Table 3-1 presents the estimates of permanent resident population in each Zone based on the 2000 Census data for Matagorda County. Census data showed a slight decrease (0.3%) in population numbers between 2000 and 2005. We conservatively estimate no change in population between year 2000 and 2007.
- Table 6-2 defines each of the 22 Evacuation Regions in terms of their respective groups of Zones.
- Table 6-3 lists the 12 Evacuation Scenarios.
- Tables 7-1C and 7-1D are compilations of Evacuation Time Estimates (ETE). These data are the times needed to *clear the indicated regions* of 95 and 100 percent of the population occupying these regions, respectively. These computed ETE include consideration of mobilization time, and of estimated voluntary evacuations from other regions within the EPZ and from the shadow region.
- Table 8-5A presents ETE for the schoolchildren in good weather.
- Table 8-7A presents ETE for the transit-dependent population in good weather.

## Conclusion

This report presents the methodological details supporting the results obtained and recommendations for consideration by local emergency responders.



**Figure 3-1. STP EPZ and Zones**

<b>Table 3-1. EPZ Permanent Resident Population</b>		
<b>Zone</b>	<b>2000 Population</b>	<b>2007 Population</b>
1	0	0
2	40	40
3	402	402
4	56	56
5	82	82
6	650	650
7	518	518
8	0	0
9	237	237
10	692	692
11	198	198
<b>TOTAL</b>	<b>2,875</b>	<b>2,875</b>
<b>Population Growth:</b>		<b>0%</b>

	<b>2000 Population</b>	<b>2007 Population</b>
<b>Matagorda Beach*</b>	116	116

\*The 116 permanent residents in the Matagorda Beach area will be evacuated under all scenarios.

Table 6-2. Description of Evacuation Regions												
Region	Description	ZONE										
		1	2	3	4	5	6	7	8	9	10	11
R01	2 mile ring											
R02	5-mile ring											
R03	Full EPZ											
Evacuate 2 mile ring and 5 miles downwind												
Region	Wind Direction (From) in Degrees	ZONE										
		1	2	3	4	5	6	7	8	9	10	11
R04	29 - 50											
R05	51 - 106											
R06	107 - 140											
R07	141 - 174											
R08	175 - 230											
R09	231 - 286											
R10	287 - 331											
R01*	332 - 28											
Evacuate 5 mile ring and downwind to EPZ boundary												
Region	Wind Direction (From) in Degrees	ZONE										
		1	2	3	4	5	6	7	8	9	10	11
R11	355 - 50											
R12	51 - 61											
R13	62 - 95											
R14	96 - 129											
R15	130 - 163											
R16	164 - 174											
R17	175 - 219											
R18	220 - 230											
R19	231 - 286											
R20	287 - 298											
R21	299 - 343											
R22	344 - 354											

**Residents and Transients in the Matagorda Beach area are always evacuated.**

\* Note that evacuating the 2-mile ring and evacuating the 5-mile ring with wind from 332° to 28° both result in the evacuation of Region1. Thus, R01 is shown twice in the table above.



Table 6-3. Evacuation Scenario Definitions					
Scenario	Season	Day of Week	Time of Day	Weather	Special
1	Summer	Midweek	Midday	Good	None
2	Summer	Midweek	Midday	Rain	None
3	Summer	Weekend	Midday	Good	None
4	Summer	Weekend	Midday	Rain	None
5	Summer	Midweek, Weekend	Evening	Good	None
6	Winter	Midweek	Midday	Good	None
7	Winter	Midweek	Midday	Rain	None
8	Winter	Weekend	Midday	Good	None
9	Winter	Weekend	Midday	Rain	None
10	Winter	Midweek, Weekend	Evening	Good	None
11	Summer	Weekend	Midday	Good	Holiday (Beachgoers)
12	Summer	Midweek	Midday	Good	New Plant Construction

Table 7-1C: Time To Clear The Indicated Area of 95 Percent of the Affected Population

Scenario: Region Wind From:	Summer			Winter			Summer			Winter		
	Midweek		Midday	Midweek		Midday	Midweek		Holiday	Midweek		Midday
	(1)	(2)	(3)	(4)	(5)	(6)	(7)	(8)	(9)	(10)	Scenario:	Region Wind From:
Entire 2-Mile Ring, 5-Mile Region, and EPZ												
R01 2-mile ring	0:55	0:55	0:50	0:50	0:50	0:55	0:55	0:50	0:50	0:50	R01 2-mile ring	0:50
R02 5-mile ring	3:10	3:20	3:00	3:00	3:20	3:40	3:40	3:50	3:50	4:10	R02 5-mile ring	3:25
R03 Entire EPZ	4:00	4:00	3:40	3:40	4:00	4:20	4:20	4:10	4:20	4:20	R03 Entire EPZ	3:50
2-Mile Ring and Downwind to 5 Miles												
R04 29° to 50°	1:00	1:00	2:30	2:30	2:50	1:00	1:00	2:50	2:50	2:50	R04 29° to 50°	2:30
R05 51° to 106°	1:50	1:50	3:25	3:25	3:30	1:50	1:50	3:40	3:40	3:40	R05 51° to 106°	3:25
R06 107° to 140°	1:30	1:30	2:50	2:50	2:40	1:30	1:30	2:50	2:50	2:50	R06 107° to 140°	2:50
R07 141° to 174°	1:50	1:50	2:50	2:50	2:40	1:50	1:50	2:50	2:50	2:50	R07 141° to 174°	2:50
R08 175° to 230°	1:00	1:00	1:30	1:30	1:30	1:00	1:00	1:30	1:30	1:30	R08 175° to 230°	1:30
R09 231° to 286°	3:00	3:00	2:50	2:50	3:00	3:30	3:30	3:40	3:40	4:00	R09 231° to 286°	3:25
R10 287° to 331°	3:00	3:00	2:50	2:50	3:00	3:30	3:30	3:40	3:40	4:00	R10 287° to 331°	3:25
R01 332° to 28°	0:55	0:55	0:50	0:50	0:50	0:55	0:55	0:50	0:50	0:50	R01 332° to 28°	0:50
5-Mile Ring and Downwind to EPZ Boundary												
R11 355° to 50°	3:50	3:50	3:40	3:40	3:50	4:10	4:10	4:10	4:10	4:20	R11 355° to 50°	3:25
R12 51° to 61°	3:40	3:40	3:20	3:20	3:50	4:10	4:10	4:10	4:10	4:20	R12 51° to 61°	3:25
R13 62° to 95°	3:40	3:40	3:20	3:20	3:50	4:10	4:10	4:10	4:10	4:20	R13 62° to 95°	3:25
R14 96° to 129°	3:50	3:50	3:30	3:30	3:50	4:10	4:10	4:10	4:10	4:20	R14 96° to 129°	3:25
R15 130° to 163°	3:30	3:30	3:00	3:00	3:30	4:00	4:00	4:00	4:00	4:10	R15 130° to 163°	3:25
R16 164° to 174°	3:50	3:50	3:20	3:20	3:50	4:10	4:10	4:10	4:10	4:20	R16 164° to 174°	3:30
R17 175° to 219°	4:00	4:00	3:40	3:40	4:00	4:10	4:10	4:10	4:10	4:20	R17 175° to 219°	3:35
R18 220° to 230°	3:50	3:50	3:40	3:40	4:00	4:10	4:10	4:10	4:10	4:20	R18 220° to 230°	3:35
R19 231° to 286°	3:50	3:50	3:40	3:40	3:50	4:10	4:10	4:10	4:10	4:20	R19 231° to 286°	3:50
R20 287° to 298°	3:20	3:20	3:00	3:00	3:30	3:50	3:50	4:00	4:00	4:10	R20 287° to 298°	3:40
R21 299° to 343°	3:20	3:20	3:00	3:00	3:30	3:50	3:50	4:00	4:00	4:10	R21 299° to 343°	3:40
R22 344° to 354°	3:50	3:50	3:40	3:40	3:50	4:10	4:10	4:10	4:10	4:20	R22 344° to 354°	3:40

Table 7-1D. Time To Clear The Indicated Area of 100 Percent of the Affected Population

Scenario: Region Wind From:	Summer		Summer		Summer		Winter		Winter		Winter		Summer											
	Midweek	(1)	Midweek	(2)	Weekend	(3)	Midweek	(4)	Midweek	(5)	Weekend	(6)	Midweek	(7)	Weekend	(8)	Midweek	(9)	Weekend	(10)	Scenario:	Region Wind From:	Summer Holiday	Summer Midweek
R01 2-mile ring	1:00	1:00	1:00	1:00	1:00	1:00	1:00	1:00	1:00	1:00	1:00	1:00	1:00	1:00	1:00	1:00	1:00	1:00	1:00	1:00	R01 2-mile ring	1:00	2:00	
R02 5-mile ring	6:00	6:10	5:10	5:10	5:10	5:10	6:00	6:00	6:00	5:10	5:10	5:10	5:10	5:10	5:10	5:10	5:10	5:10	5:10	5:10	R02 5-mile ring	5:10	6:00	
R03 Entire EPZ	6:10	6:10	5:50	5:50	5:50	5:50	6:10	6:10	6:10	6:10	6:10	6:10	6:10	6:10	6:10	6:10	6:10	6:10	6:10	6:10	R03 Entire EPZ	5:50	6:10	
Entire 2-Mile Region, 5-Mile Region, and EPZ																								
2-Mile Ring and Downwind to 5 Miles																								
R04 29° to 50°	4:50	5:00	4:50	4:50	4:50	4:50	4:50	4:50	4:50	4:50	4:50	4:50	4:50	4:50	4:50	4:50	4:50	4:50	4:50	4:50	R04 29° to 50°	4:50	5:00	
R05 51° to 106°	4:50	5:00	5:00	5:00	5:00	5:00	5:00	5:00	5:00	5:00	5:00	5:00	5:00	5:00	5:00	5:00	5:00	5:00	5:00	5:00	R05 51° to 106°	5:00	5:00	
R06 107° to 140°	4:50	4:50	5:00	5:00	5:00	5:00	4:50	4:50	4:50	5:00	5:00	4:50	4:50	4:50	5:00	5:00	5:00	5:00	5:00	5:00	R06 107° to 140°	5:00	5:00	
R07 141° to 174°	4:50	4:50	5:00	5:00	5:00	5:00	5:00	5:00	4:50	4:50	5:00	4:50	4:50	5:00	5:00	5:00	5:00	5:00	5:00	5:00	R07 141° to 174°	5:00	5:00	
R08 175° to 230°	3:50	3:50	2:50	2:50	2:50	2:50	3:50	3:50	3:50	2:50	2:50	3:50	3:50	2:50	2:50	2:50	2:50	2:50	2:50	2:50	R08 175° to 230°	2:50	3:50	
R09 231° to 286°	6:00	6:10	5:10	5:10	5:10	5:10	6:00	6:00	6:00	6:00	6:00	6:00	6:00	6:00	6:00	6:00	6:00	6:00	6:00	6:00	R09 231° to 286°	5:10	6:00	
R10 287° to 331°	6:00	6:10	5:10	5:10	5:10	5:10	6:00	6:00	6:00	6:00	6:00	6:00	6:00	6:00	6:00	6:00	6:00	6:00	6:00	6:00	R10 287° to 331°	5:10	6:00	
R01 332° to 28°	1:00	1:00	1:00	1:00	1:00	1:00	1:00	1:00	1:00	1:00	1:00	1:00	1:00	1:00	1:00	1:00	1:00	1:00	1:00	1:00	R01 332° to 28°	1:00	2:00	
5-Mile Ring and Downwind to EPZ Boundary																								
R11 355° to 50°	6:00	6:10	5:50	5:50	5:50	5:50	6:00	6:00	6:00	6:00	6:00	6:00	6:00	6:00	6:00	6:00	6:00	6:00	6:00	6:00	R11 355° to 50°	5:50	6:00	
R12 51° to 61°	6:00	6:10	5:50	5:50	5:50	5:50	6:00	6:00	6:00	6:00	6:00	6:00	6:00	6:00	6:00	6:00	6:00	6:00	6:00	6:00	R12 51° to 61°	5:50	6:00	
R13 62° to 95°	6:00	6:10	5:50	5:50	5:50	5:50	6:00	6:00	6:00	6:00	6:00	6:00	6:00	6:00	6:00	6:00	6:00	6:00	6:00	6:00	R13 62° to 95°	5:50	6:00	
R14 96° to 129°	6:00	6:10	5:50	5:50	5:50	5:50	6:00	6:00	6:00	6:00	6:00	6:00	6:00	6:00	6:00	6:00	6:00	6:00	6:00	6:00	R14 96° to 129°	5:50	6:00	
R15 130° to 163°	6:00	6:10	5:10	5:10	5:10	5:10	6:00	6:00	6:00	6:00	6:00	6:00	6:00	6:00	6:00	6:00	6:00	6:00	6:00	6:00	R15 130° to 163°	5:10	6:00	
R16 164° to 174°	6:10	6:10	5:20	5:20	5:20	5:20	6:10	6:10	6:10	6:10	6:10	6:10	6:10	6:10	6:10	6:10	6:10	6:10	6:10	6:10	R16 164° to 174°	5:10	6:00	
R17 175° to 219°	6:10	6:10	5:20	5:20	5:20	5:20	6:10	6:10	6:10	6:10	6:10	6:10	6:10	6:10	6:10	6:10	6:10	6:10	6:10	6:10	R17 175° to 219°	5:10	6:10	
R18 220° to 230°	6:10	6:10	5:20	5:20	5:20	5:20	6:10	6:10	6:10	6:10	6:10	6:10	6:10	6:10	6:10	6:10	6:10	6:10	6:10	6:10	R18 220° to 230°	5:10	6:10	
R19 231° to 286°	6:10	6:10	5:20	5:20	5:20	5:20	6:10	6:10	6:10	6:10	6:10	6:10	6:10	6:10	6:10	6:10	6:10	6:10	6:10	6:10	R19 231° to 286°	5:10	6:10	
R20 287° to 298°	6:10	6:10	5:10	5:10	5:10	5:10	6:10	6:10	6:10	6:10	6:10	6:10	6:10	6:10	6:10	6:10	6:10	6:10	6:10	6:10	R20 287° to 298°	5:10	6:00	
R21 299° to 343°	6:10	6:10	5:10	5:10	5:10	5:10	6:10	6:10	6:10	6:10	6:10	6:10	6:10	6:10	6:10	6:10	6:10	6:10	6:10	6:10	R21 299° to 343°	5:10	6:00	
R22 344° to 354°	6:10	6:10	5:50	5:50	5:50	5:50	6:10	6:10	6:10	6:10	6:10	6:10	6:10	6:10	6:10	6:10	6:10	6:10	6:10	6:10	R22 344° to 354°	5:50	6:00	

**Table 8-5A. School Evacuation Time Estimates - Good Weather**

School	Driver Mobilization and Travel Time from Depot (min)	Loading Time (min)	Dist. to EPZ Boundary (mi.)		Average Speed (mph)	Adjusted Speed (mph)	Travel Time to EPZ Bdry (min)	To Bdry ETE (min)	To Bdry ETE (hr:min)	Dist. EPZ Bdry to R.C.		Travel Time EPZ Bdry to RC (min)	ETE to R.C. (min)	ETE to R.C. (hr:min)	
			Major Road	Local Road						Major Road	Local Road				
<b>Matagorda County Schools</b>															
Matagorda Elementary School	30	5	15	1.7	54.0	50.0	20.0	60	1:00	1.5	1.4	5	65	1:05	
Tidehaven Middle School to Markham E.S.	30	5	7.8	0	59.6	50.0	9.4	45	0:45	0	1.0	2	50	0:50	
Tidehaven High School to Markham E.S.	30	5	6.2	0	70.2	50.0	7.4	45	0:45	0	1.0	2	45	0:45	
Tidehaven Middle School to Blessing E.S.	30	5	6.4	0	53.9	50.0	7.7	45	0:45	0	0.1	1	45	0:45	
Tidehaven High School to Blessing E.S.	30	5	4.8	0	62.6	50.0	5.8	45	0:45	0	0.1	1	45	0:45	
							<b>Maximum for EPZ:</b>		60	<b>1:00</b>	<b>Maximum:</b>		3	65	<b>1:05</b>
<b>ETE rounded up to the nearest 5 minutes</b>							<b>Average for EPZ:</b>		50	<b>0:50</b>	<b>Average:</b>		2	50	<b>0:50</b>

**Table 8-7A. Transit-Dependent Evacuation Time Estimates - GOOD WEATHER**

Route Number	Single Wave										Second Wave (After School Evacuation)										
	Mobilization and Travel Time to EPZ	Route Length (mi.)	Average Speed (mph)	Adjusted Speed (mph)	Run Travel Time	Pickup Time	ETE (min)	ETE (hr:min)	Arrive at RC	Unload	Driver Rest	Return to EPZ	Average Speed (mph)	Adjusted Speed (mph)	Run Travel Time	Pickup Time	ETE (min)	ETE (hr:min)			
1	150	6.3	63.4	50.0	7.6	15	175	2:55	50	5	15	2	63.4	50.0	15.12	15	105	1:45			
2	150	17.0	50.0	50.0	20.4	15	190	3:10	50	5	15	2	50.0	50.0	40.8	15	130	2:10			
3	150	5.5	53.1	50.0	6.6	15	175	2:55	50	5	15	2	53.1	50.0	13.2	15	105	1:45			
							<b>Maximum for EPZ:</b>		190	<b>3:10</b>		<b>Maximum for EPZ:</b>							130	<b>2:10</b>	
<b>Average for EPZ:</b>							180	<b>3:00</b>		<b>Average for EPZ:</b>							115	<b>1:55</b>			

## 1. INTRODUCTION

This report describes the analyses undertaken and the results obtained by a study to update the existing Evacuation Time Estimates (ETE) for the South Texas Project (STP), located in Matagorda County, Texas. Evacuation time estimates provide State and local governments with site-specific information needed for Protective Action decision-making.

In the performance of this effort, all available prior documentation relevant to Evacuation Time Estimates was reviewed.

Other guidance is provided by documents published by Federal Government agencies. Most important of these are:

- Criteria for Preparation and Evaluation of Radiological Emergency Response Plans and Preparedness in Support of Nuclear Power Plants, NUREG-0654/FEMA-REP-1, Rev. 2, November 1980.
- Analysis of Techniques for Estimating Evacuation Times for Emergency Planning Zones, NUREG/CR-1745, November 1980.
- Development of Evacuation Time Estimates for Nuclear Power Plants, NUREG/CR-6863, January 2005.

We wish to express our appreciation to all the directors and staff members of the Matagorda County emergency management agencies and local and state law enforcement agencies, who provided valued guidance and contributed information contained in this report.

### 1.1 Overview of the ETE Update Process

The following outline presents a brief description of the work effort in chronological sequence:

1. Information Gathering:
  - Defined the scope of work in discussion with representatives of South Texas Project.
  - Reviewed existing reports describing past evacuation studies.
  - Attended meetings with emergency planners from Matagorda County to identify issues to be addressed and resources available.
  - Conducted a detailed field survey of the Emergency Planning Zone (EPZ) highway system and of area traffic conditions.

- Obtained demographic data from census and state agencies.
  - Conducted a random sample telephone survey of EPZ residents.
  - Conducted a data collection effort to identify and describe schools, special facilities, major employers, transportation providers, and other important sources of information.
2. Estimated distributions of Trip Generation times representing the time required by various population groups (permanent residents, employees, and transients) to prepare (mobilize) for the evacuation trip. These estimates are primarily based upon the random sample telephone survey.
  3. Defined Evacuation Scenarios. These scenarios reflect the variation in demand, trip generation distribution and in highway capacities, associated with different seasons, day of week, time of day and weather conditions.
  4. Defined a traffic management strategy. Traffic control is applied at specified Traffic Control Points (TCP) located within the EPZ. Local and state police personnel have reviewed all traffic control plans.
  5. Defined Evacuation Areas or Regions. The EPZ is partitioned into Zones which serve as a basis for the ETE analysis presented herein. Evacuation “Regions” are comprised of a group of contiguous Zones for which ETE are calculated. The configuration of these Regions reflects the fact that the wind can take any direction and that the radial extent of the impacted area depends on accident-related circumstances. Each Region, other than those that approximate circular areas, approximates a “key-hole” configuration within the EPZ as recommended by NUREG/CR-6863.
  6. Estimated demand for transit services for persons at “Special Facilities” and for transit-dependent persons at home.
  7. Prepared the input streams for the IDYNEV system.
    - Estimated the traffic demand, based on the available information derived from Census data, from prior studies, from data provided by local and state agencies and from the telephone survey.
    - Applied the procedures specified in the 2000 Highway Capacity Manual (HCM<sup>1</sup>) to the data acquired during the field survey, to estimate the capacity of all highway segments comprising the evacuation routes.

---

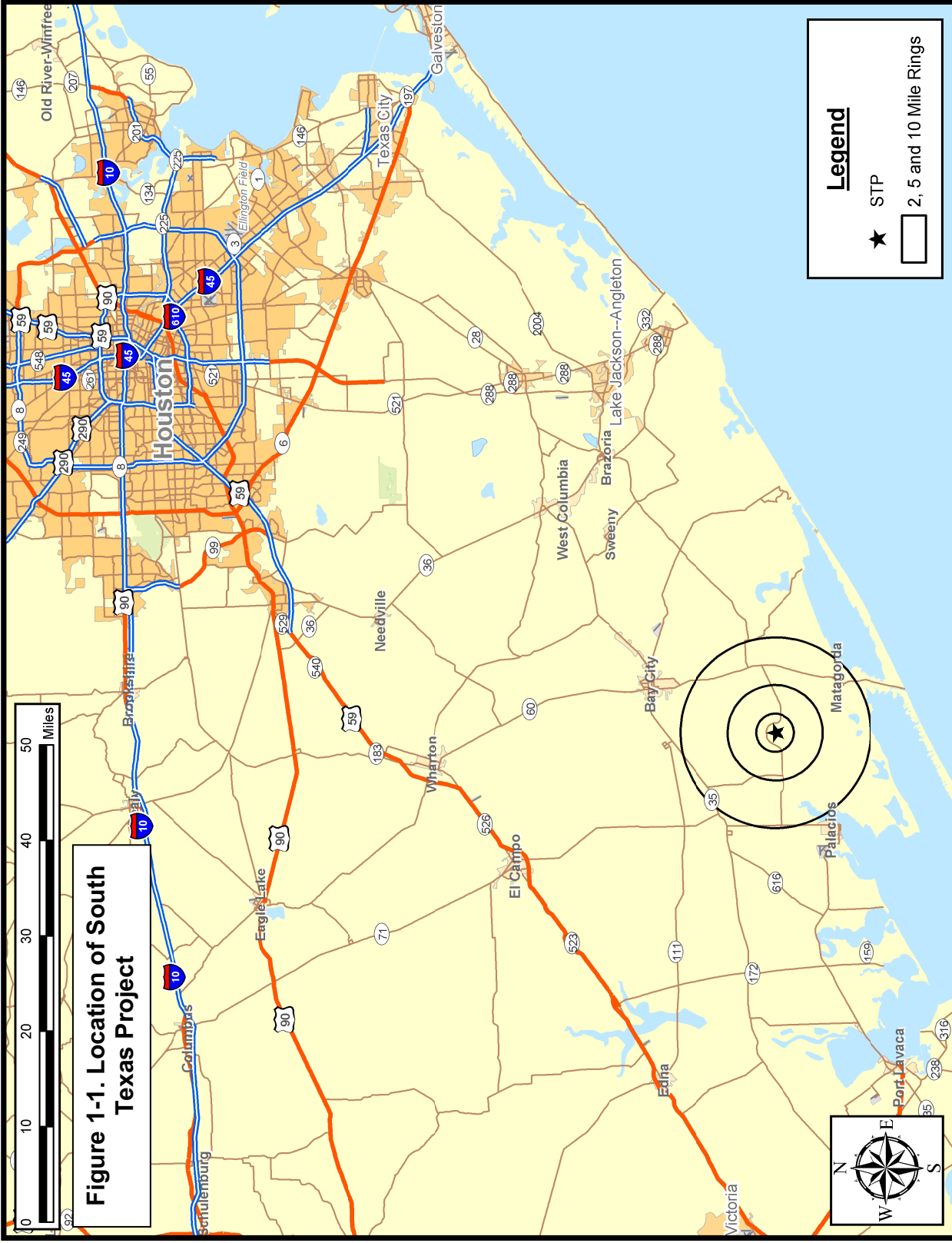
<sup>1</sup> Highway Capacity Manual (HCM2000), Transportation Research Board, National Research Council, 2000.

- Developed the link-node representation of the evacuation network, which is used as the basis for the computer analysis that calculates the ETE.
  - Calculated the evacuating traffic demands for each Region and for each Evacuation Scenario. Considered the effects on demand of “voluntary evacuation” and of the “shadow effect”.
  - Represented the traffic management strategy.
  - Specified the candidate destinations of evacuation travel consistent with outbound movement relative to the location of the STP.
  - Prepared the input stream for the IDYNEV System.
8. Executed the IDYNEV models to provide the estimates of evacuation routing and ETE for all residents, transients and employees (“general population”) with access to private vehicles. Generated a complete set of ETE for all specified Regions and Evacuation Scenarios.
  9. Documented ETE in formats responsive to NUREG-0654.
  10. Calculated the ETE for all transit activities including those for schools and for the transit-dependent population.

Steps 7 and 8 are iterated as described in Appendix D.

## 1.2 The South Texas Project Site Location

The STP is located in Matagorda County, Texas, approximately 13 miles south-southwest of Bay City, and 75 miles south-southwest of Houston. A portion of the EPZ is on the Gulf Coast (E/W Matagorda Bay) and Tres Palacios Bay. The area has many lakes, rivers, creeks, and a barrier island that attracts many transients. The area is sparsely populated; Matagorda is the largest community. Figure 1-1 displays the area surrounding the STP. This map identifies the communities in the area and the major roads.





### 1.3 Preliminary Activities

Since this plan constitutes an update of an existing document, it was necessary to review the prior process and findings. These activities are described below.

#### Literature Review

KLD Associates was provided with copies of documents describing past studies and analyses leading to the development of emergency plans and of the ETE. We also obtained supporting documents from a variety of sources, which contained information needed to form the database used for conducting evacuation analyses.

#### Field Surveys of the Highway Network

KLD personnel drove the highway system within the EPZ and for some distance outside. The characteristics of each section of highway were recorded. These characteristics include:

• Number of lanes	• Posted speed
• Pavement Width	• Actual free speed
• Shoulder type & width	• Abutting land use
• Intersection configuration	• Control devices
• Lane channelization	• Interchange geometries
• Geometrics: Curves, grades	
• Unusual characteristics: Narrow bridges, sharp curves, poor pavement, flood warning signs, inadequate delineations, etc.	

The data were then transcribed; this information was referenced while preparing the input stream for the IDYNEV System.

#### Telephone Survey

A telephone survey was undertaken to gather information needed for the evacuation study. Appendix F presents the survey instrument, the procedures used and tabulations of data compiled from the survey returns.

These data were utilized to develop estimates of vehicle occupancy during an evacuation and to estimate elements of the mobilization process. This database was also referenced to estimate the number of transit-dependent residents.

## Developing the Evacuation Time Estimates

The ETE overall procedure is outlined in Appendix D. Demographic data were obtained from several sources, as detailed later in this report. These data were analyzed and converted into vehicle demand data.

Highway capacity was estimated for each highway segment based on the field surveys and on the principles specified in the 2000 Highway Capacity Manual (HCM). The link-node representation of the physical highway network was developed using Geographic Information System (GIS) mapping software and the observations obtained from the field survey. This network representation of “links” and “nodes” is shown in Figure 1-2.

### Analytical Tools

The IDYNEV System that was employed for this study is comprised of several integrated computer models. One of these is the PC-DYNEV (DYnamic Network EVacuation) macroscopic simulation model that was developed by KLD under contract with the Federal Emergency Management Agency (FEMA).

IDYNEV consists of three submodels:

- A macroscopic traffic simulation model (for details, see Appendix C).
- An intersection capacity model (for details, see Highway Research Record No. 772, Transportation Research Board, 1980, papers by Lieberman and McShane & Lieberman).
- A dynamic, node-centric routing model that adjusts the “base” routing in the event of an imbalance in the levels of congestion on the outbound links.

Another model of the IDYNEV System is the TRAD (TRaffic Assignment and Distribution) model. This model integrates an equilibrium assignment model with a trip distribution algorithm to compute origin-destination volumes and paths of travel designed to minimize travel time. For details, see Appendix B.

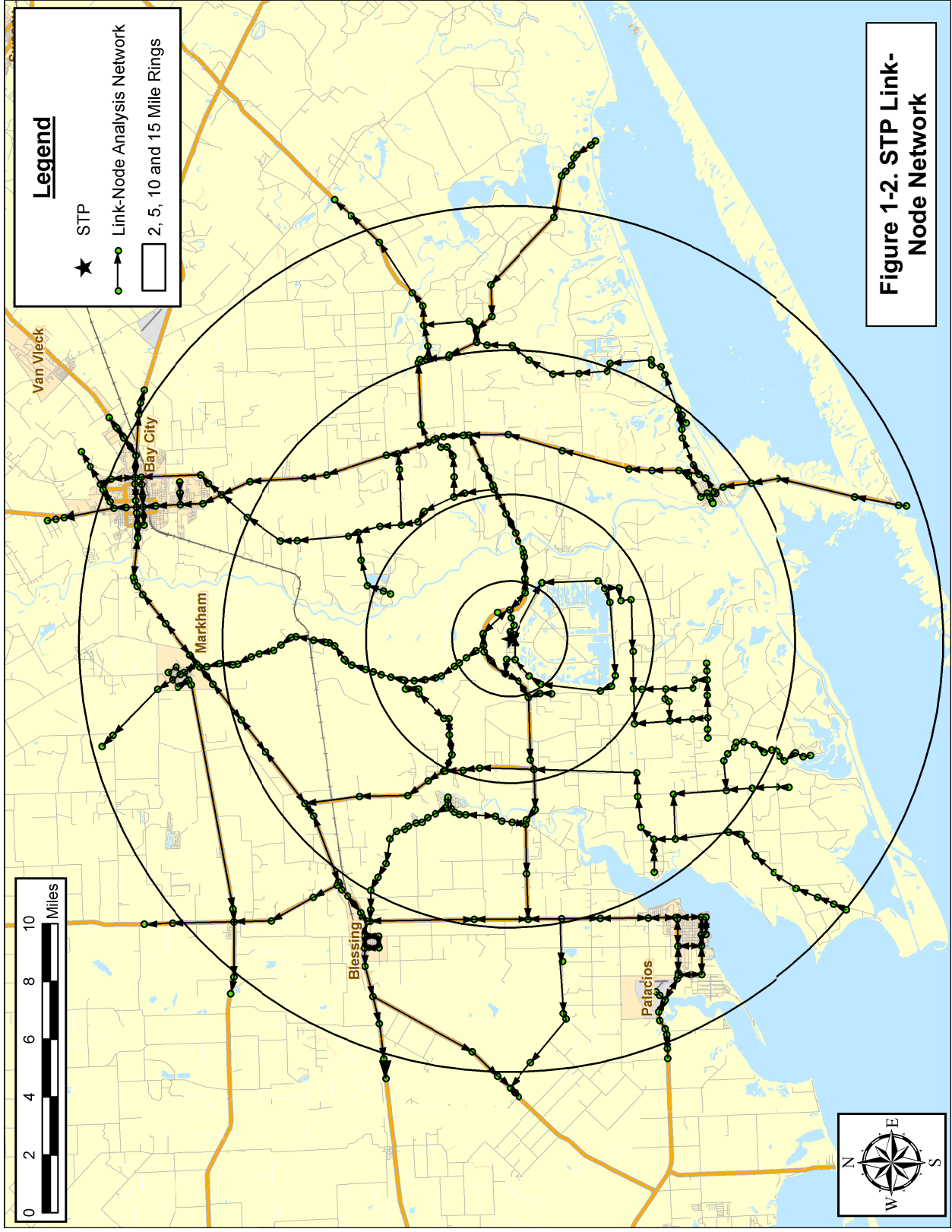
Still another software product developed by KLD, named UNITES (UNified Transportation Engineering System) was used to expedite data entry.

The procedure for applying the IDYNEV System within the framework of developing an update to an ETE is outlined in Appendix D. Appendix A is a glossary of terms.

For the reader interested in more details of the model than are provided in Appendices

B, C and D, and in Highway Research Record No. 772 (discussed in Section 4 of this report), the following references are suggested:

- NUREG/CR-4873 – Benchmark Study of the I-DYNEV Evacuation Time Estimate Computer Code
- NUREG/CR-4874 – The Sensitivity of Evacuation Time Estimates to Changes in Input Parameter for the I-DYNEV Computer Code



The evacuation analysis procedures are based upon the need to:

- Route traffic along paths of travel that will expedite their travel from their respective points of origin to points outside the EPZ
- Restrict movement toward STP to the extent practicable, and disperse traffic demand so as to avoid focusing demand on a limited number of highways
- Move traffic in directions that are generally outbound, relative to the location of STP.

A set of candidate destination nodes on the periphery of the EPZ is specified for each traffic origin (or centroid) within the EPZ. The TRAD model produces output that identifies the "best" traffic routing, subject to the design conditions outlined above. In addition to this information, rough estimates of travel time are provided, together with turn-movement data required by the PC-DYNEV simulation model.

The simulation model is then executed to provide a detailed description of traffic operations on the evacuation network. This description enables the analyst to identify bottlenecks and to develop countermeasures that are designed to expedite the movement of vehicles. The outputs of this model are the volume of traffic, expressed as vehicles/hour, that exits the Evacuation Region along the various highways (links) that cross the Region boundaries. These outputs are exported into a spreadsheet which contains the ETE. Section 7 presents a further description of this process along with the ETE Tables.

As outlined in Appendix D, this procedure consists of an iterative design-analysis-redesign sequence of activities. When performed properly, this procedure converges to yield an evacuation plan which best services the evacuating public.

#### 1.4 Comparison with Prior ETE Study

Table 1-1 presents a comparison of the present ETE study with the 1994 study. The major factors contributing to the differences between the ETE values obtained in this study and those of the previous study can be summarized as follows:

- Vehicle occupancy rates based on the results of a telephone survey of EPZ residents.
- Voluntary and shadow evacuations are considered.
- Trip Generation times are based on the results of a telephone survey of EPZ residents, which resulted in significantly longer mobilization times than those assumed in the previous study.

<b>Table 1-1. ETE Study Comparisons</b>		
<b>Topic</b>	<b>Treatment</b>	
	<b>Previous ETE Study</b>	<b>Current ETE Study</b>
Resident Population Basis	1990 US Census block data used. Resident Population = 3,040	ArcGIS Software using 2000 US Census blocks; block centroid method used; population extrapolated to 2007.  Population = 2,875
Resident Population Vehicle Occupancy	Average household size of 2.5 used. 1 person/evacuating vehicle.	2.38 persons/household, 1.43 evacuating vehicles/household yielding: 1.66 persons/vehicle
Employee Population	Employees grouped with transient population. 1 employee/vehicle.	Employees treated as separate population group. Employee estimates based on information provided by Matagorda County about major employers in the EPZ. 1.01 employees/vehicle based on phone survey results.
Voluntary evacuation from within EPZ in areas outside region to be evacuated	Not considered	50 percent of population within the circular portion of the region; 35 percent, in annular ring between the circle and the EPZ boundary (See Figure 2-1).
Shadow Evacuation	Not considered.	30% of people outside of the EPZ and within the shadow area (See Figure 7-2).
Network Size	349 links; 58 nodes.	574 Links; 389 Nodes.
Roadway Geometric Data	Field surveys conducted in 1994.	Field surveys conducted in 2007.  Road capacities based on 2000 HCM.
School Evacuation	Direct evacuation to designated Reception Center/Host School.	Direct evacuation to designated Reception Center/Host School.

**Table 1-1. ETE Study Comparisons**

Topic	Treatment	
	Previous ETE Study	Current ETE Study
Transit Dependent Population	Not considered.	Defined as households with 0 vehicles + households with 1 vehicle with commuters who do not return home + households with 2 vehicles with commuters who do not return home. Telephone survey results used to estimate transit dependent population.
Ridesharing	Not considered.	50 percent of transit dependent persons will ride out with a neighbor or friend.
Trip Generation for Evacuation	<p>Assumed mobilization times as follows:</p> <p>Permanent and seasonal residents between 30 and 150 minutes. Distribution based on assumptions.</p> <p>Employees and transients leave between 30 and 60 minutes.</p> <p>School buses leave between 30 and 90 minutes.</p> <p>All times measured from the Advisory to Evacuate.</p>	<p>Based on residential telephone survey of specific pre-trip mobilization activities:</p> <p>Residents with commuters returning leave between 45 minutes and 6 hours.</p> <p>Residents without commuters returning leave between 15 minutes and 5 hours.</p> <p>Employees and transients leave between 10 minutes and 2 hours.</p> <p>All times measured from the Advisory to Evacuate.</p>
Traffic and Access Control	Not considered.	Traffic Control used in all scenarios to facilitate the flow of traffic outbound relative to STP.
Weather	Fair, Adverse and flooding.	Normal, or Rain. The capacity and free flow speed of all links in the network are reduced by 10% in the event of rain.

**Table 1-1. ETE Study Comparisons**

Topic	Treatment	
	Previous ETE Study	Current ETE Study
Modeling	NETVAC simulation model, developed by EARTH TECH.	IDYNEV System: TRAD and PC-DYNEV.
Special Events	Peak Holiday.	Peak Holiday and New Plant Construction.
Evacuation Cases	35 Regions (single sector wind direction used) and 8 Scenarios producing 280 cases (some redundancy)	22 Regions (single sector wind direction used) and 12 Scenarios producing 264 unique cases
Evacuation Time Estimates Reporting	One ETE reported for each case. Results presented by Region and Scenario	ETE reported for 50 <sup>th</sup> , 90 <sup>th</sup> , 95 <sup>th</sup> , and 100 <sup>th</sup> percentile population. Results presented by Region and Scenario.
Evacuation Time Estimates for the entire EPZ.	Full EPZ – Summer Weekday: Good weather = 3:00 Full EPZ – Summer Weekend: Good weather = 3:05	For the 100 <sup>th</sup> percentile: Summer Weekday Midday Good weather = 6:10 Summer Weekend Midday Good weather = 5:50  For the 95 <sup>th</sup> percentile (recommended for use in making Protective Action decisions), these ETE are 4:00 and 3:40, respectively.



## 2. STUDY ESTIMATES AND ASSUMPTIONS

This section presents the estimates and assumptions utilized in the development of the evacuation time estimates.

### 2.1 Data Estimates

1. Population estimates are based upon 2000 Census data, projected to year 2007. County-specific projections are based upon growth rates estimated by comparing the 2000 census data and 2005 census estimates. Estimates of employees who commute into the EPZ to work are based upon employment data obtained from county emergency management officials.
2. Population estimates at special facilities are based on available data from county emergency management offices.
3. Roadway capacity estimates are based on field surveys and the application of Highway Capacity Manual 2000<sup>1</sup>.
4. Population mobilization times are based on a statistical analysis of data acquired from the telephone survey.
5. The relationship between resident population and evacuating vehicles is developed from the telephone survey. Values of 2.38 persons per household and 1.43 evacuating vehicles per household are used.
6. The relationship between persons and vehicles for special facilities is as follows:
  - a. Recreational Areas: 1 vehicle per family
  - b. Employees: 1.01 employees per vehicle (telephone survey results)
7. Evacuation Time Estimates (ETE) are presented for the evacuation of the 100<sup>th</sup> percentile of population for each Region and for each Scenario, and for the 2-mile, 5-mile and 10-mile distances. ETE are presented in tabular format and graphically, also showing the values of ETE associated with the 50<sup>th</sup>, 90<sup>th</sup> and 95<sup>th</sup> percentiles of population. A Region is defined as a group of Zones that is issued the Advisory to Evacuate.

---

<sup>1</sup> Highway Capacity Manual (HCM2000), Transportation Research Board, National Research Council, 2000.

## 2.2 Study Methodological Assumptions

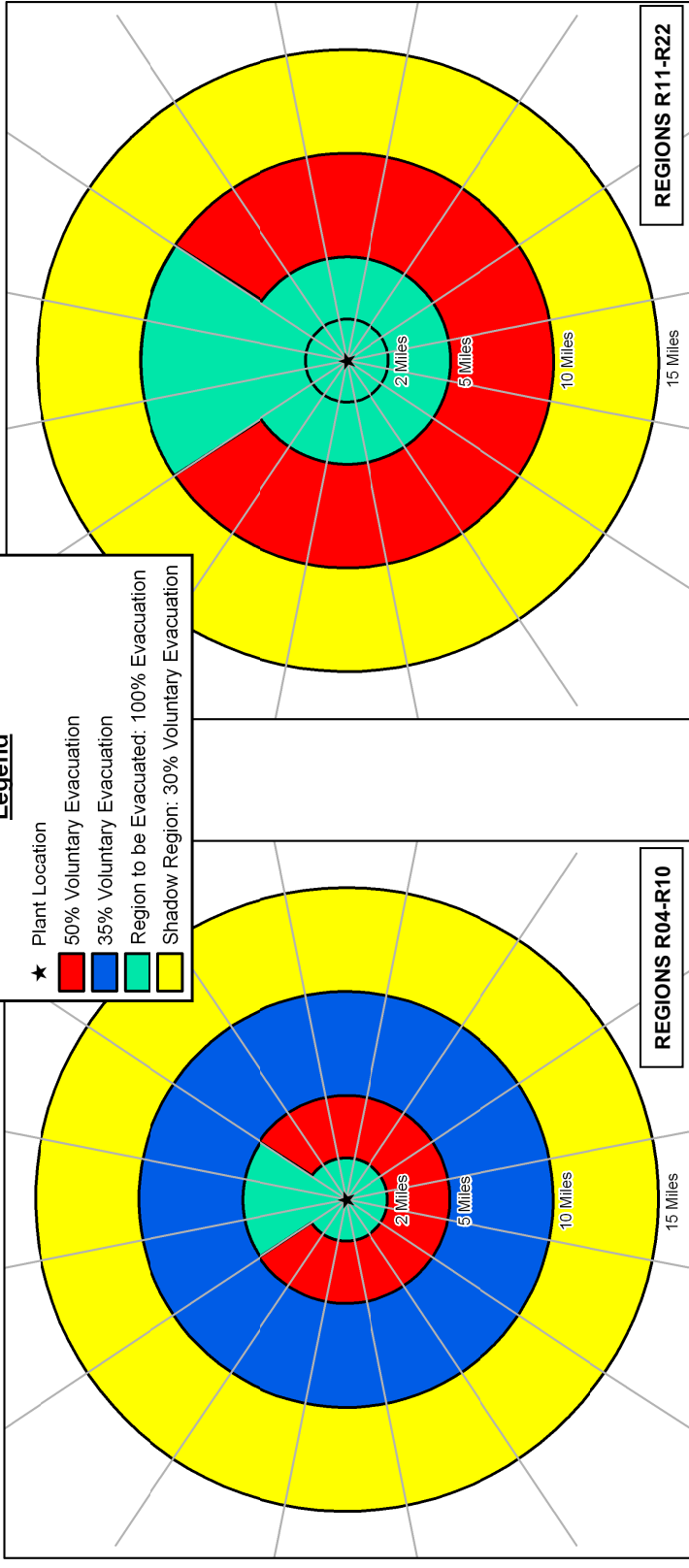
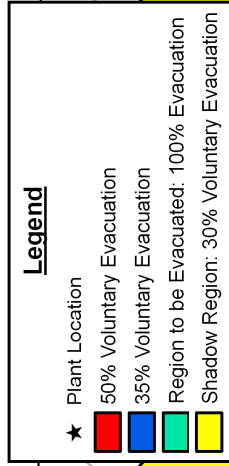
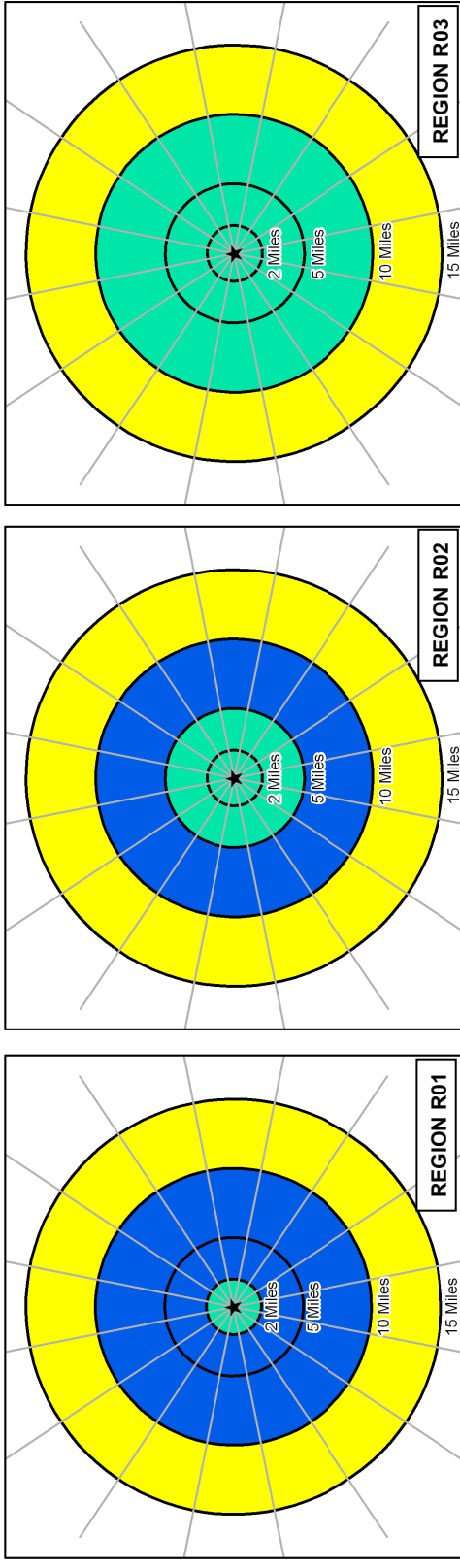
1. The ETE is defined as the elapsed time from the Advisory to Evacuate issued to a specific Region of the EPZ, and the time that Region is clear of people.
2. The ETE are computed and presented in a format compliant with the guidance in the cited NUREG documentation. The ETE for each evacuation area (“Region” comprised of included Zones) is presented in both statistical and graphical formats.
3. Evacuation movements (paths of travel) are generally outbound relative to the power plant to the extent permitted by the highway network, as computed by the computer models. All available evacuation routes are used in the analysis.
4. Regions are defined by the underlying “keyhole” or circular configurations as specified in NUREG/CR-6863, using the wind directions specified in the STP Offsite Protection Action Recommendations. These Regions, as defined, display irregular boundaries reflecting the geography of the Zones included within these underlying configurations.
5. Voluntary evacuation is considered as indicated in the accompanying Figure 2-1. Within the circle defined by the distance to be evacuated but outside the Evacuation Region, 50 percent of the people not advised to evacuate are assumed to evacuate within the same time-frame. In the annular area between the circle defined by the extent of the Evacuation Region and the EPZ boundary, it is assumed that 35 percent of people will voluntarily evacuate. In the area between the EPZ boundary and a 15-mile annular area centered at the plant (the “shadow region”), it will be assumed that 30 percent of the people will evacuate voluntarily. Sensitivity studies explored the effect on ETE, of increasing the percentage of voluntary evacuees in this area. (Appendix I) The basis for our assumptions on voluntary evacuation is testimony proffered by Dennis Miletti, a professor at Colorado State University, and one of the nations top disaster response experts, at Atomic Safety and Licensing Board (ASLB) hearings, which were deemed acceptable. There are limited data pertaining to nuclear evacuations in the United States. The numbers we use are Professor Miletti’s best estimates based on his years of experience in evacuation planning and emergency preparedness.

6. A total of 12 “Scenarios” representing different seasons, time of day, day of week and weather are considered. Two special event scenarios are studied: the construction period of a new nuclear plant and a Holiday weekend with an extra 5,000 people on the beach. These Scenarios are tabulated below:

<b>Scenario</b>	<b>Season</b>	<b>Day of Week</b>	<b>Time of Day</b>	<b>Weather</b>	<b>Special</b>
1	Summer	Midweek	Midday	Good	None
2	Summer	Midweek	Midday	Rain	None
3	Summer	Weekend	Midday	Good	None
4	Summer	Weekend	Midday	Rain	None
5	Summer	Midweek, Weekend	Evening	Good	None
6	Winter	Midweek	Midday	Good	None
7	Winter	Midweek	Midday	Rain	None
8	Winter	Weekend	Midday	Good	None
9	Winter	Weekend	Midday	Rain	None
10	Winter	Midweek, Weekend	Evening	Good	None
11	Summer	Weekend	Midday	Good	Holiday Beachgoers
12	Summer	Midweek	Midday	Good	New Plant Construction

7. The models of the IDYNEV System were recognized as state of the art by Atomic Safety & Licensing Boards (ASLB) in past hearings. (Sources: Atomic Safety & Licensing Board Hearings on Seabrook and Shoreham; Urbanik<sup>2</sup>). The models have continuously been refined and extended since those hearings and have been independently validated by a consultant retained by the NRC.

<sup>2</sup> Urbanik, T., et. al. Benchmark Study of the I-DYNEV Evacuation Time Estimate Computer Code, NUREG/CR-4873, Nuclear Regulatory Commission, June, 1988



**Figure 2-1. Voluntary Evacuation Methodology**

## 2.3 Study Assumptions

1. The Planning Basis Assumption for the calculation of ETE is a rapidly escalating accident that requires evacuation, and includes the following:
  - a. Advisory to Evacuate is announced coincident with the siren notification.
  - b. Mobilization of the general population will commence within 10 minutes after siren notification.
  - c. ETE are measured relative to the Advisory to Evacuate.
2. It is assumed that everyone within the group of Zones forming a Region that is issued an Advisory to Evacuate will, in fact, respond in general accord with the planned routes.
3. It is further assumed that:
  - a. Schools will be given the earliest notification possible so they can begin evacuating prior to notification of the general public, if conditions permit. In the case of a rapidly escalating accident, however, this may not be possible.
  - b. 70 percent of those households in the EPZ with commuters will await the return of a commuter before beginning their evacuation trip, based on the telephone survey results.
4. A portion of the population outside the evacuated Region will elect to evacuate even though not advised to do so (“voluntary evacuation”). See Figure 2.1.
5. The ETE will also include consideration of “through” (External-External) trips during the time that such traffic is permitted to enter the evacuated Region. “Normal” traffic flow is assumed to be present within the EPZ at the start of the emergency.
6. Traffic Control Points (TCP) within the EPZ will be staffed over time, beginning at the Advisory to Evacuate. Their number and location will depend on the Region to be evacuated and resources available. It is assumed that drivers will act rationally, travel in the directions identified in the plan, and obey all control devices and traffic guides.
7. Traffic Control Points (TCP) outside the EPZ should be established to facilitate evacuation flow to the Reception Centers.
8. Buses will be used to transport those without access to private vehicles:
  - a. If schools are in session, transport (buses) will evacuate students before the issuance of an Advisory to Evacuate to the general public, directly to the assigned Reception Centers.
  - b. School children, if school is in session, are given priority in assigning transit vehicles.

- c. Bus mobilization time is considered in ETE calculations.
  - d. Analysis of the number of required “waves” of transit vehicles used for evacuation is presented.
9. The transit-dependent portion of the general population will be evacuated to reception centers by bus. It is reasonable to assume that some of these people will ride-share with family, neighbors, and friends, thus reducing the demand for buses. We assume that the percentage of people who rideshare is 50 percent. This assumption is based upon reported experience for other emergencies,<sup>3</sup> which cites previous evacuation experience.
10. Rain may occur for either winter or summer scenarios. In the case of rain, it is assumed that the rain begins at about the same time as the evacuation advisory is issued. No weather-related reduction in the number of transients who may be present in the EPZ is assumed. Adverse weather scenarios affect roadway capacity, free flow highway speeds and the time required to mobilize the general population. The factors assumed for the ETE study are:

<b>Scenario</b>	<b>Highway Capacity*</b>	<b>Free Flow Speed*</b>	<b>Mobilization Time</b>
Rain <sup>4</sup>	90%	90%	No Effect
*Adverse weather capacity and speed values are given as a percentage of good weather conditions. Roads are assumed to be passable.			

11. School buses used to transport students are assumed to transport 70 children per bus for elementary schools, and 50 children per bus for middle and high schools. Transit buses used to transport the transit-dependent general population are assumed to transport an average of 30 people per bus.

<sup>3</sup> Institute for Environmental Studies, University of Toronto, THE MISSISSAUGA EVACUATION FINAL REPORT, June 1981. The report indicates that 6,600 people of a transit-dependent population of 8,600 people shared rides with other residents; a ride share rate of 76% (Page 5-10).

<sup>4</sup> Agarwal, M. et. Al. Impacts of Weather on Urban Freeway Traffic Flow Characteristics and Facility Capacity, Proceedings of the 2005 Mid-Continent Transportation Research Symposium, August, 2005.

### 3. DEMAND ESTIMATION

The estimates of demand, expressed in terms of people and vehicles, constitute a critical element in developing an evacuation plan. These estimates consist of three components:

1. An estimate of population within the Emergency Planning Zone (EPZ), stratified into groups (resident, employee, transient).
2. An estimate, for each population group, of mean occupancy per evacuating vehicle. This estimate is used to determine the number of evacuating vehicles.
3. An estimate of potential double-counting of vehicles.

Appendix E presents much of the source material for the population estimates. Our primary source of population data, the 2000 Census, however, is not adequate for directly estimating some transient groups.

Throughout the year, vacationers and tourists enter the EPZ. These non-residents may dwell within the EPZ for a short period (e.g. a few days or one or two weeks), or may enter and leave within one day. Estimates of the size of these population components must be obtained, so that the associated number of evacuating vehicles can be ascertained.

The potential for double-counting people and vehicles must be addressed. For example:

- A resident who works and shops within the EPZ could be counted as a resident, again as an employee and once again as a shopper.
- A visitor who stays at a motel, spends time at a beach, then goes shopping could be counted three times.

Furthermore, the number of vehicles at a location depends on time of day. For example, motel parking lots may be full at dawn and empty at noon. Similarly, parking lots at area parks, which are full at noon, may be almost empty at dawn. Estimating counts of vehicles by simply adding up the capacities of different types of parking facilities will tend to overestimate the number of transients and can lead to ETE that are too conservative.

Analysis of the population characteristics of the South Texas Project (STP) EPZ indicates the need to identify three distinct groups:

- Permanent residents - people who are year-round residents of the EPZ.
- Transients - people who reside outside of the EPZ, who enter the area for a specific purpose (e.g., beach or summer home) and then leave the area.
- Employees - people who reside outside the EPZ and commute to businesses within the EPZ on a daily basis.

Estimates of the population and number of evacuating vehicles for each of the population groups are presented for each Zone and by polar coordinate representation (population rose). The STP EPZ has been subdivided into 11 Zones. These Zones are shown in Figure 3-1.

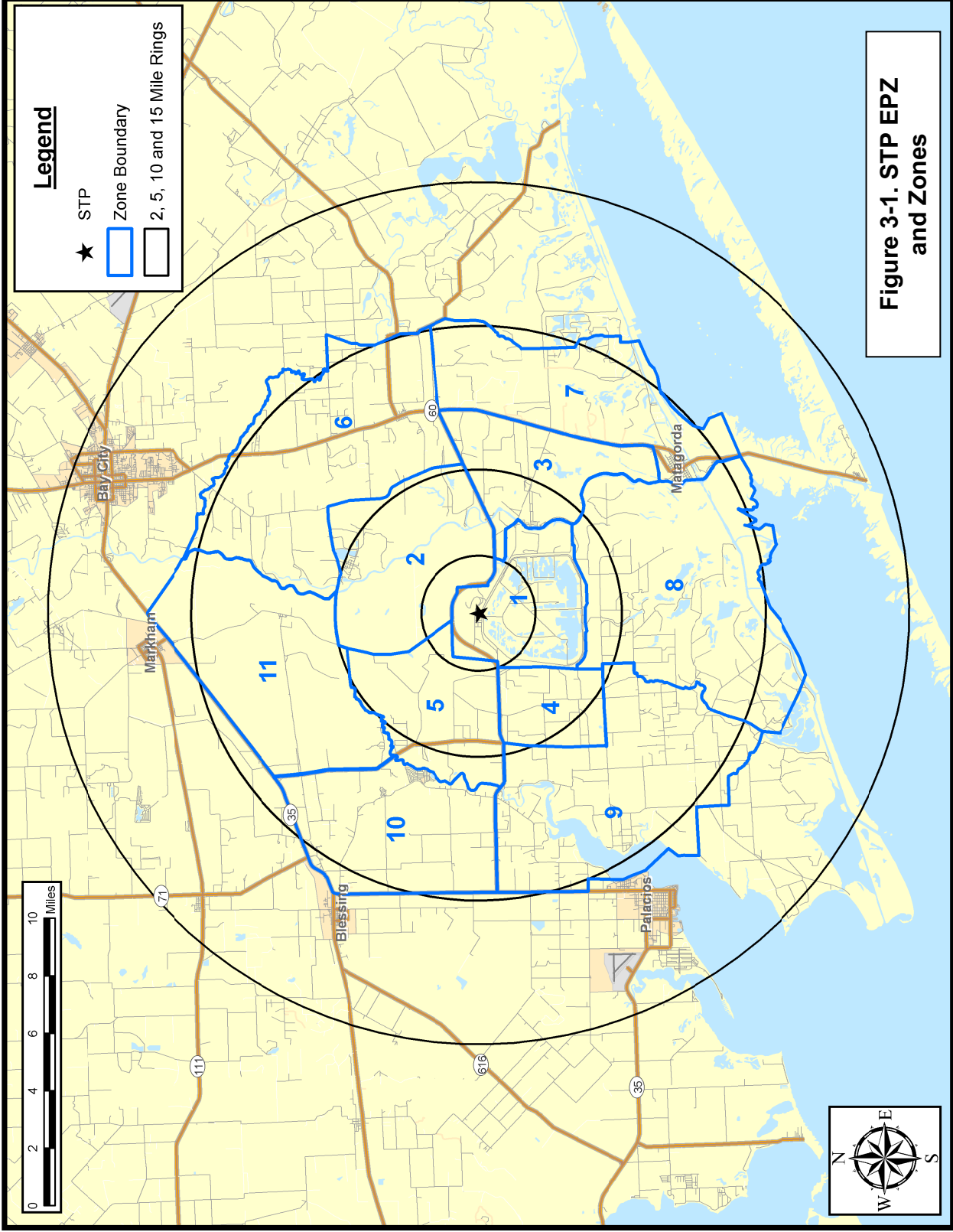
### Permanent Residents

The primary source for estimating permanent population is 2000 U.S. Census data. The average household size (2.38 persons/household) and the number of evacuating vehicles per household (1.43 vehicles/household) were adapted from the telephone survey results.

Comparing census estimates available for the year 2005, with those for 2000, the yearly rate of population change was estimated and used to project the year 2000 resident population to a 2007 base year. According to census data, the population of Matagorda County decreased by 0.3 percent from April 1, 2000 to July 1, 2005. We conservatively estimate that the population remains unchanged, as shown in Table 3-1.

Permanent resident population and vehicle estimates for 2007 are presented in Table 3-2. Figures 3-2 and 3-3 present the permanent resident population and permanent resident vehicle estimates by sector and distance from STP.





**Figure 3-1. STP EPZ and Zones**

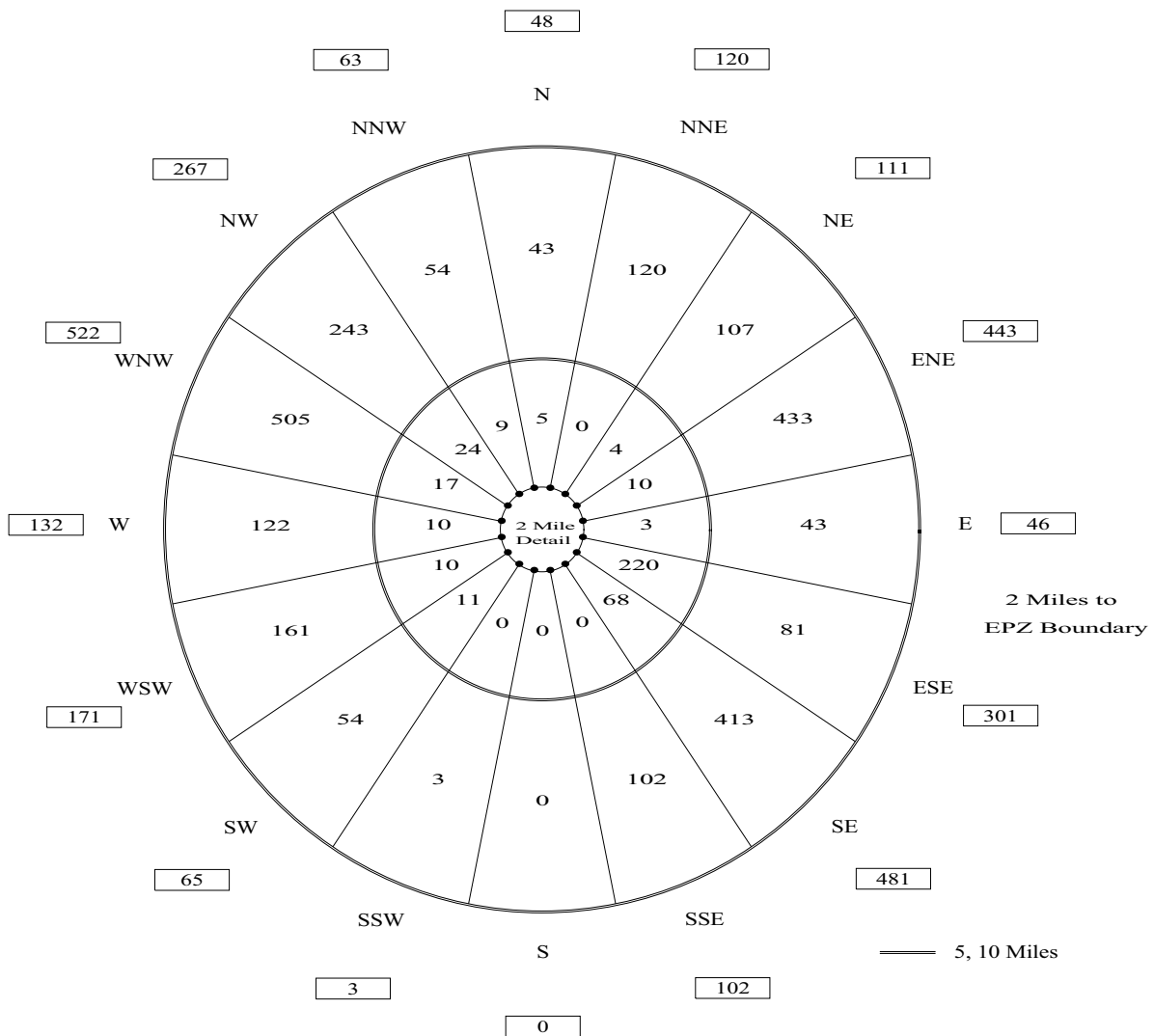
<b>Table 3-1. EPZ Permanent Resident Population</b>		
<b>Zone</b>	<b>2000 Population</b>	<b>2007 Population</b>
1	0	0
2	40	40
3	402	402
4	56	56
5	82	82
6	650	650
7	518	518
8	0	0
9	237	237
10	692	692
11	198	198
<b>TOTAL</b>	<b>2,875</b>	<b>2,875</b>
<b>Population Growth:</b>		<b>0%</b>

	<b>2000 Population</b>	<b>2007 Population</b>
<b>Matagorda Beach*</b>	116	116

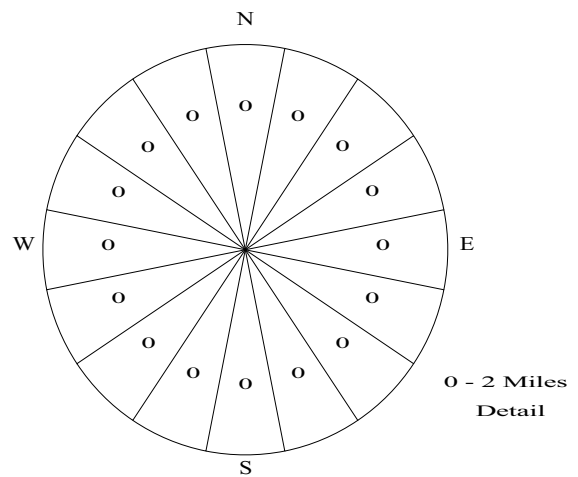
**\*The Matagorda Beach area has only one access road - FM 2031, which cuts through the STP EPZ. It is prudent to evacuate both the resident and transient population on the beach in the event of an emergency, since an escalation of the event or a change in wind direction could expose those evacuees on FM 2031 to the plume. Thus, it is assumed that in every scenario and for every region these people will be evacuated, and their vehicles will be included in the network traffic.**

<b>Table 3-2. Permanent Resident Population and Vehicles by Zone</b>		
<b>Zone</b>	<b>2007 Population</b>	<b>2007 Vehicles</b>
1	0	0
2	40	24
3	402	241
4	56	34
5	82	49
6	650	391
7	518	310
8	0	0
9	237	142
10	692	414
11	198	119
<b>TOTAL</b>	<b>2,875</b>	<b>1,724</b>

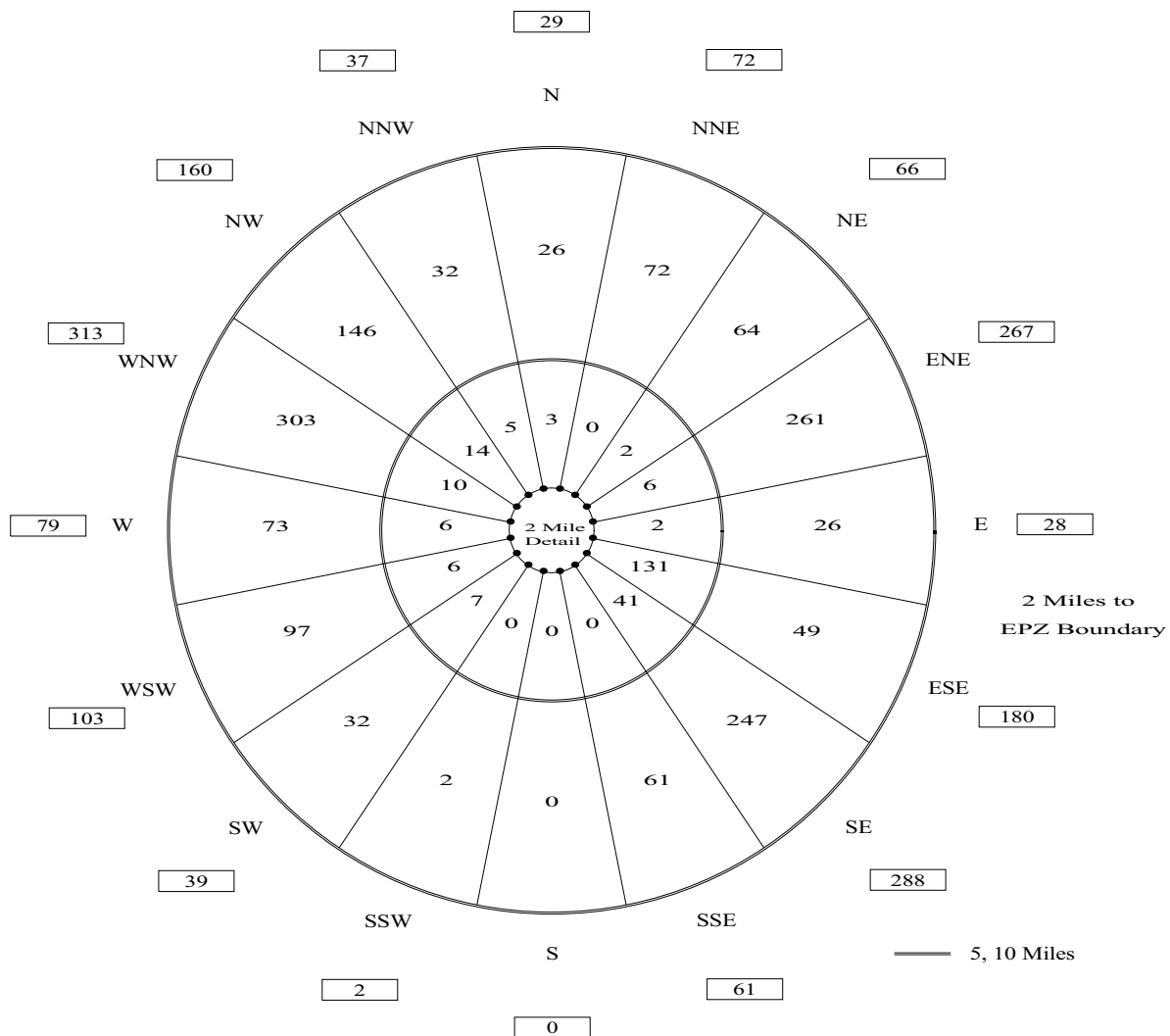
	<b>2007 Population</b>	<b>2007 Vehicles</b>
<b>Matagorda Beach</b>	116	70



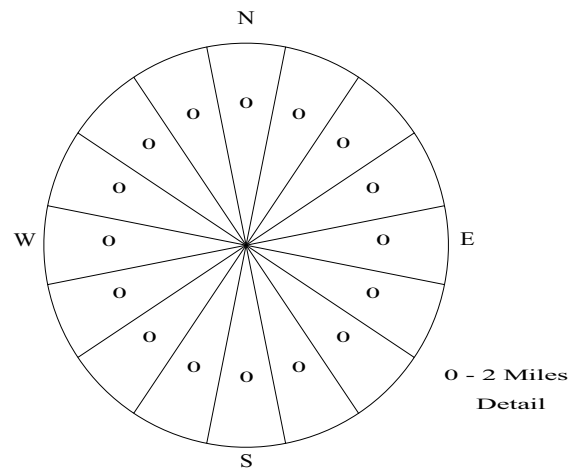
Resident Population			
Miles	Ring Subtotal	Total Miles	Cumulative Total
0-2	0	0-2	0
2-5	391	0-5	391
5-10	2484	0-10	2875



**Figure 3-2. Permanent Residents by Sector**



Resident Vehicles			
Miles	Ring Subtotal	Total Miles	Cumulative Total
0-2	0	0-2	0
2-5	233	0-5	233
5-10	1491	0-10	1724



**Figure 3-3. Permanent Resident Vehicles by Sector**

## Transient Population

Transient population groups are defined as those people who are not permanent residents and who enter the EPZ for a specific purpose (shopping, recreation). Transients may spend less than one day or stay overnight at camping facilities, hotels and motels. The South Texas Project EPZ has a number of areas that attract transients, including:

- Riverside Park and Campgrounds
- Matagorda Harbor
- Lighthouse RV Park

Estimates of the peak attendance at transient facilities were provided by County emergency management offices; the number of evacuating vehicles was also provided. Internet searches were also used to obtain more detailed information about these facilities and supplement the data provided. The transient population estimates are as follows:

### Rio Colorado Golf Course

The Rio Colorado Golf Course is located nine miles north-northeast of STP, in Zone 6. This facility is busiest from March to November, when the daily average number of transients is estimated as 120 people, traveling in 60 vehicles.

### Matagorda Harbor

Matagorda Harbor is located on the Intracoastal Waterway approximately nine miles southeast of STP, in Zone 7. It provides mooring for approximately 222 boats and has 26 RV spaces available to boat slip patrons. The peak attendance is estimated as 300 persons evacuating in 150 vehicles.

### Lighthouse RV Park

The Lighthouse RV Park is located approximately seven miles east-southeast of STP. The number of transients during peak times is estimated to be 50 people, traveling in 25 vehicles.

### Riverside Park and Campgrounds

The Riverside Park covers 100 acres on the eastern side of the Colorado River, approximately 10 miles north-northeast of STP. Patrons of the Park may be involved in a number of outdoor activities including fishing, camping, jet-skiing, and bird-watching. There are camp ground facilities and picnic sites. It is estimated that 180 people may be in the Park at peak times. The number of evacuating vehicles is estimated as 60.

### Hotels and Motels

There are 3 motels in the EPZ; all of these facilities are located in Zone 7. Appendix E details the hotel data provided. The peak attendance at these motels is estimated as 110 people evacuating in 50 vehicles.

### Seasonal Homes

The seasonal resident population data was taken from the previous ETE report (Earth Tech 1994), as updated information on seasonal homes was not available. A total of 2,817 seasonal residents were estimated to be residing within the EPZ. Since most of the seasonal dwellings are summer homes, 100% transient population was assumed for the summer weekend scenario. These homes are located in Zones 7, 9 and 10 and add a total of 1,693 evacuating vehicles to the evacuating traffic.

### Matagorda Beach and Jetty Park

The beach, Jetty Park and fishing pier are busiest in the summer months. The weekend average number of visitors was estimated to be 1,000 people, driving 500 vehicles. However, on a Holiday there can be as many as 6,000 people on or near the beach. Although strictly outside of the EPZ, transients in this facility are evacuated under every scenario and are considered in the computation of ETE.

### Matagorda Bay Nature Park

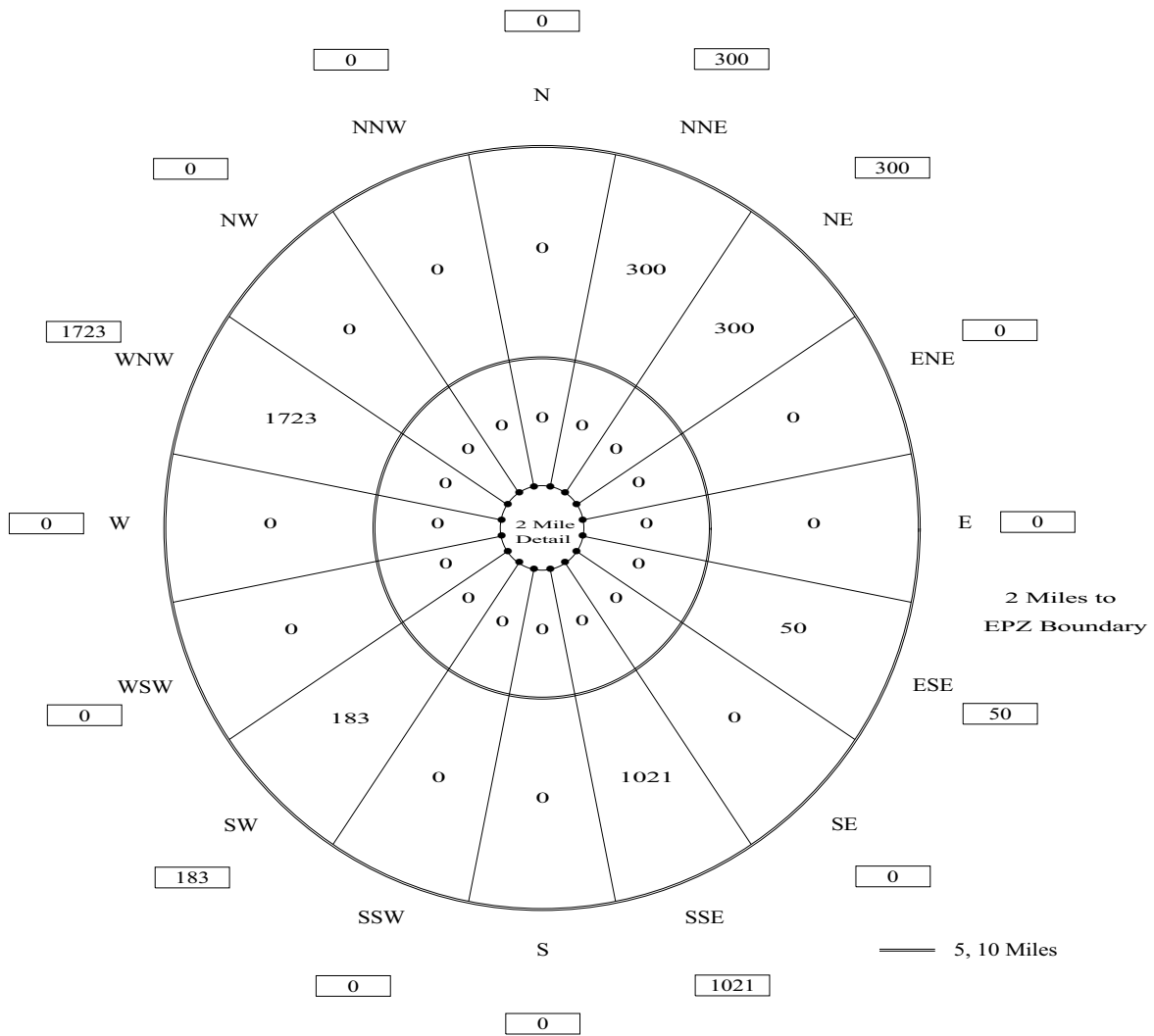
Matagorda Bay Nature Park is a 1,600-acre park and preserve at the mouth of the Colorado River. The park borders the Gulf of Mexico for two miles, has two miles of river frontage and hundreds of acres of coastal marshes and dunes. Patrons of the Park may partake in a number of outdoor activities including fishing, camping, and bird-watching. The RV Park can accommodate 70 vehicles. The number of transients during peak times is estimated to be 130 people, traveling in 70 vehicles.

<b>Table 3-3. Summary of Transients by Zone</b>		
<b>Zone</b>	<b>Transients</b>	<b>Transient Vehicles</b>
1	0	0
2	0	0
3	50	25
4	0	0
5	0	0
6	300	120
7	1,431	813
8	0	0
9	73	44
10	1,723	1,035
11	0	0
<b>TOTAL</b>	<b>3,577</b>	<b>2,037</b>

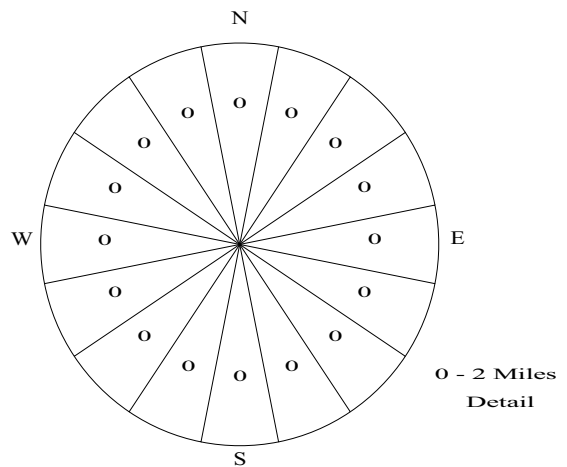
	<b>Transients</b>	<b>Transient Vehicles</b>
<b>Matagorda Beach*</b>	1,130	570

**\*The 1130 transients in the Matagorda Beach area will be evacuated under all scenarios**

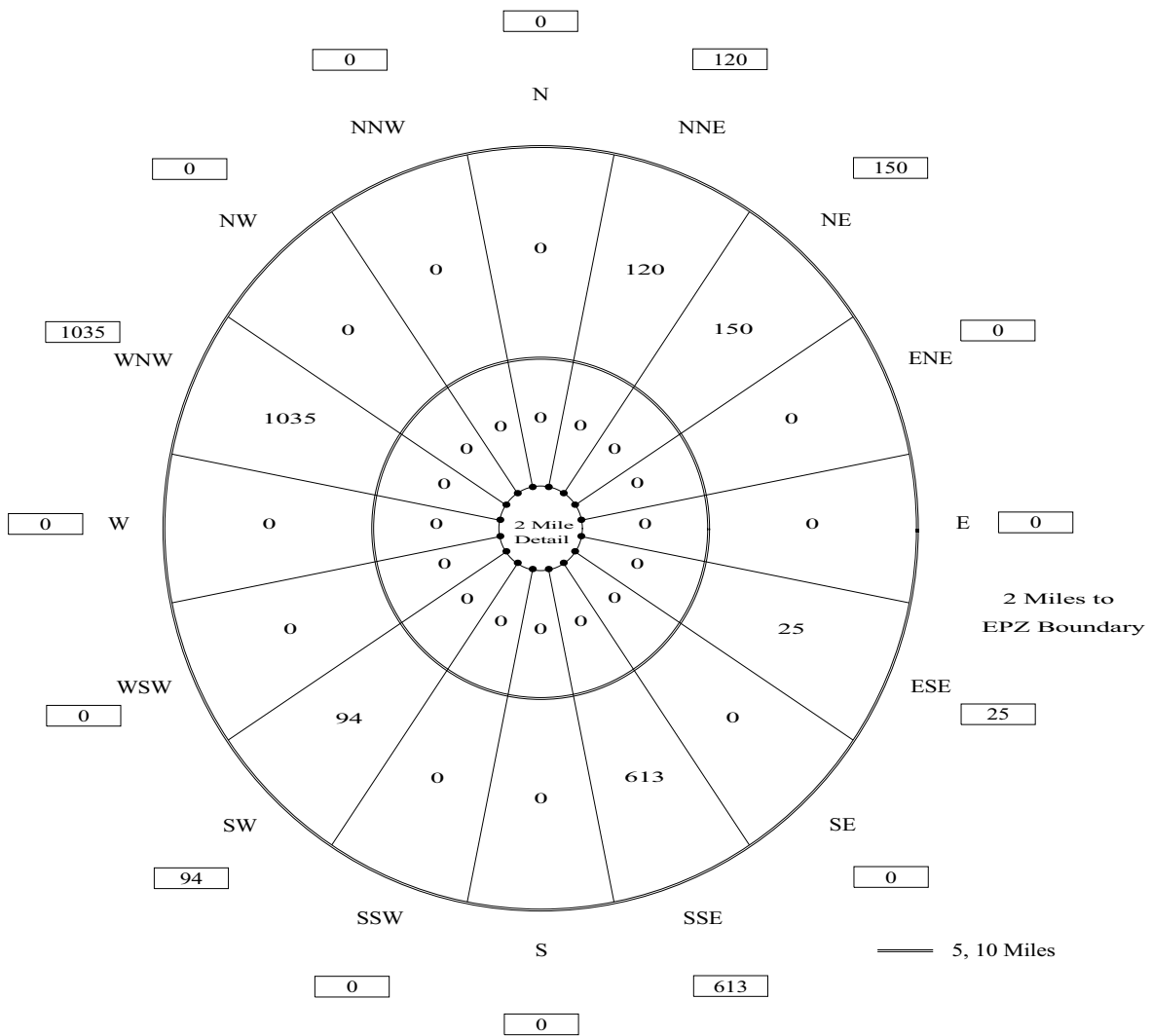




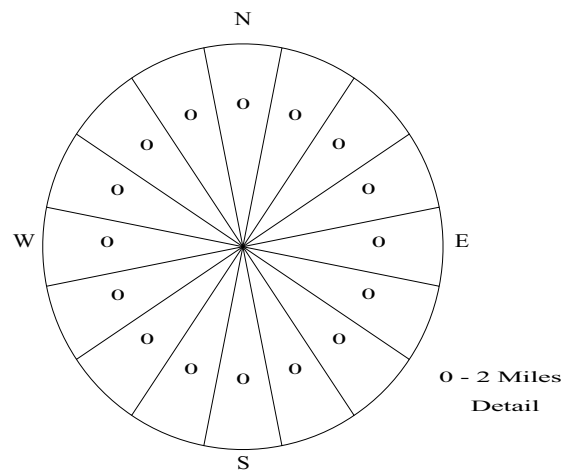
Transient Population			
Miles	Ring Subtotal	Total Miles	Cumulative Total
0-2	0	0-2	0
2-5	0	0-5	0
5-10	3577	0-10	3577



**Figure 3-4. Transient Population by Sector**



Transient Vehicles			
Miles	Ring Subtotal	Total Miles	Cumulative Total
0-2	0	0-2	0
2-5	0	0-5	0
5-10	2037	0-10	2037



**Figure 3-5. Transient Vehicles by Sector**

## Employees

Employees who work within the EPZ fall into two categories:

- Those who live and work in the EPZ
- Those who live outside of the EPZ and commute to jobs within the EPZ.

Those of the first category are already counted as part of the permanent resident population. To avoid double counting, we focus on those commuting employees who live outside the EPZ and will evacuate along with the permanent resident population.

Data for major employers in the EPZ was provided by the Matagorda County emergency management office. The location of these facilities was mapped using GIS software. The GIS map was overlaid with the evacuation analysis network and employees were loaded onto appropriate links. The map of major employers in the EPZ can be seen in Appendix E.

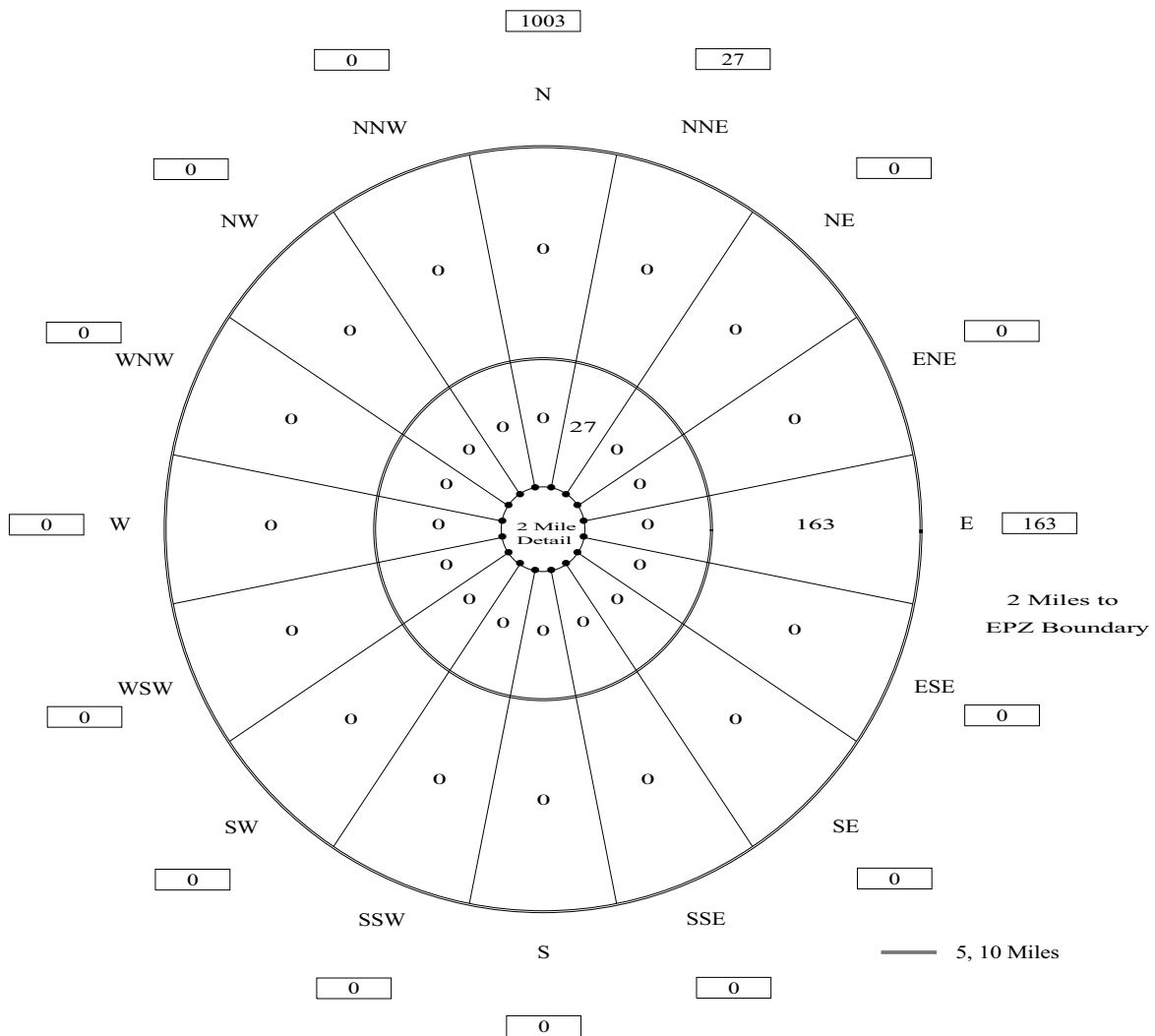
An occupancy of 1.01 persons per employee-vehicle obtained from the telephone survey, was used to determine the number of evacuating employee vehicles.

Table 3-4 presents non-EPZ resident employees and vehicle estimates by Zone. Figures 3-6 and 3-7 present these data by sector.

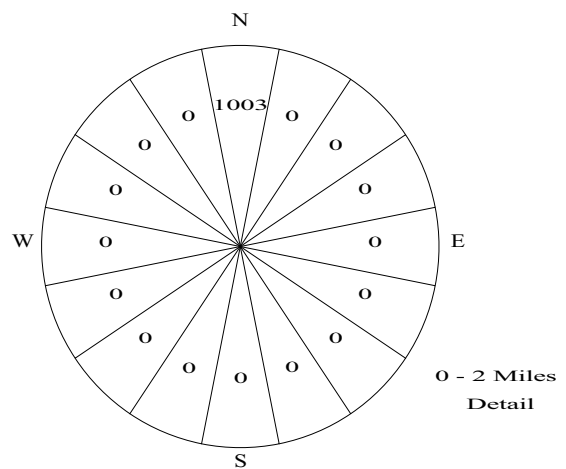
## Pass-Through Demand

Vehicles will be traveling through the EPZ (external-external trips) at the time of an accident. After the Advisory to Evacuate is announced, these through travelers will also evacuate. These through vehicles are assumed to travel on the major routes through the EPZ (e.g., US Hwy 35). It is assumed that this traffic will continue to enter the EPZ during the first 90 minutes following the Advisory to Evacuate. We estimate approximately 600 vehicles per hour enter the EPZ as external-external trips during this period for a total of 900 vehicles before access control is implemented.

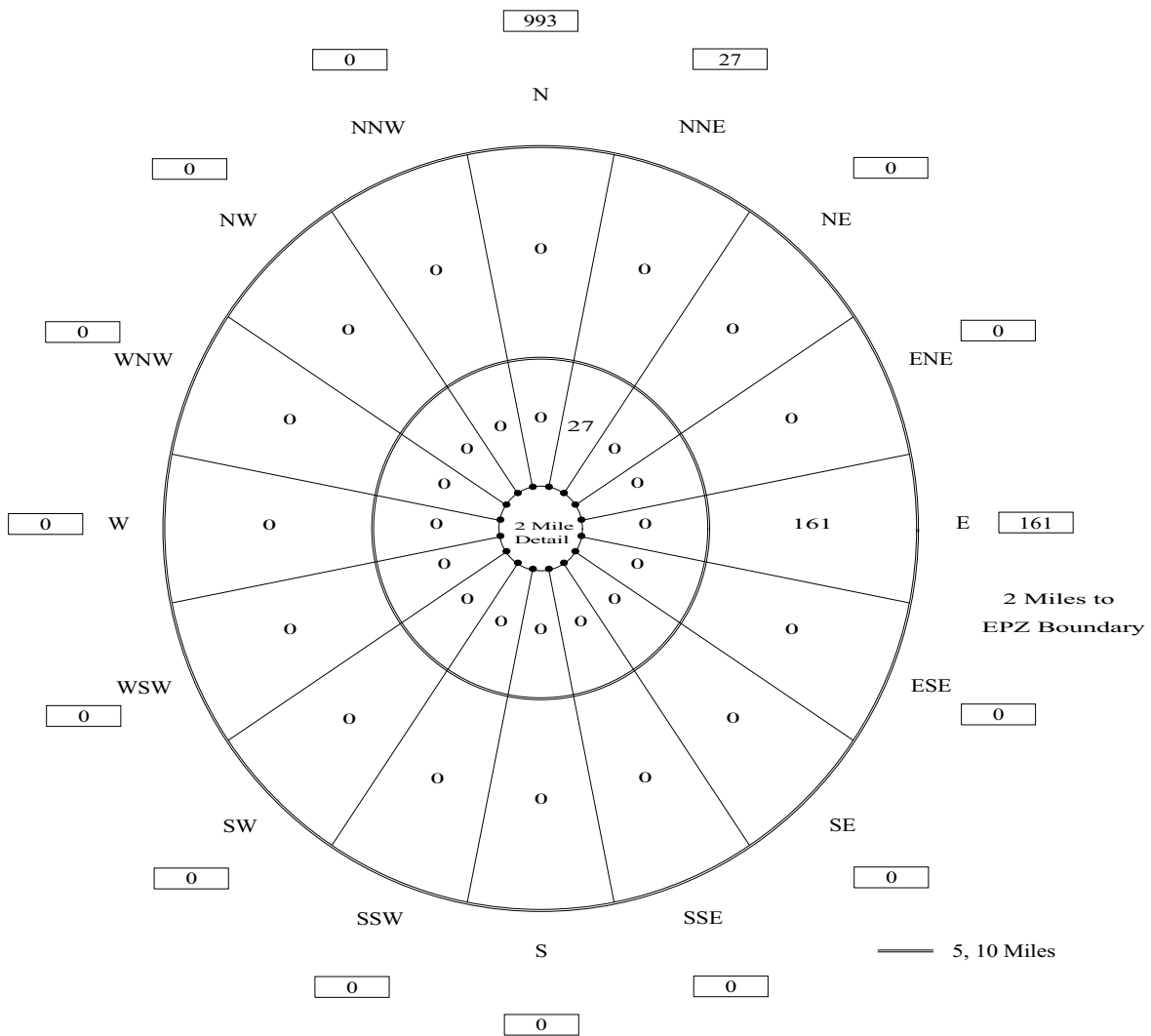
<b>Table 3-4. Summary of Non-EPZ Employees by Zone</b>		
<b>Zone</b>	<b>Total Non-EPZ Employees</b>	<b>Employee Vehicles</b>
1	1,003	993
2	27	27
3	163	161
4	0	0
5	0	0
6	0	0
7	0	0
8	0	0
9	0	0
10	0	0
11	0	0
<b>TOTAL</b>	<b>1,193</b>	<b>1,181</b>



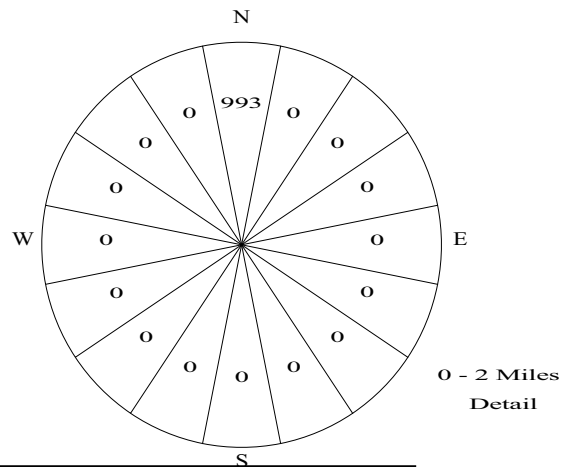
Employees			
Miles	Ring Subtotal	Total Miles	Cumulative Total
0-2	1003	0-2	1003
2-5	27	0-5	1030
5-10	163	0-10	1193



**Figure 3-6. Non-Resident Employee Population by Sector**



Employee Vehicles			
Miles	Ring Subtotal	Total Miles	Cumulative Total
0-2	993	0-2	993
2-5	27	0-5	1020
5-10	161	0-10	1181



**Figure 3-7. Non-Resident Employee Vehicles by Sector**

#### 4. ESTIMATION OF HIGHWAY CAPACITY

The ability of the road network to service vehicle demand is a major factor in determining how rapidly an evacuation can be completed. The capacity of a road is defined as the maximum hourly rate at which persons or vehicles can reasonably be expected to traverse a point or uniform section of a lane of roadway during a given time period under prevailing roadway, traffic and control conditions as stated in the 2000 Highway Capacity Manual (HCM).

In discussing capacity, different operating conditions have been assigned alphabetical designations, A through F, to reflect the range of traffic operational characteristics. These designations have been termed "Levels of Service" (LOS). For example, LOS A connotes free-flow and high-speed operating conditions; LOS F represents a forced flow condition. LOS E describes traffic operating at or near capacity.

Another concept, closely associated with capacity, is "Service Volume" (SV). Service volume is defined as "The maximum hourly rate at which vehicles, bicycles or persons reasonably can be expected to traverse a point or uniform section of a roadway during an hour under specific assumed conditions while maintaining a designated level of service." This definition is similar to that for capacity. The major distinction is that values of SV vary from one LOS to another, while capacity is the service volume at the upper bound of LOS E, only.

This distinction is illustrated in Exhibit 12-15 of the HCM. As indicated there, the SV varies with Free Flow Speed (FFS), Terrain and LOS. However, the SV at LOS E (which approximates capacity) varies only with Terrain. This Exhibit was referenced when estimating capacity for two-lane rural highways within the EPZ and Shadow Region; such highways are predominant within the analysis network.

Other factors also influence capacity. These include, but are not limited to:

- Lane width
- Shoulder width
- Pavement Condition
- Percent Truck Traffic
- Weather conditions (rain, snow, fog, wind speed, ice)

These factors are considered during the road survey and in the capacity estimation process; some factors have greater influence on capacity than others. For example, lane and shoulder width have only a limited influence on free flow speed (FFS) according to Exhibit 20-5 of the HCM. Consequently, lane and shoulder widths at the narrowest points were observed during the road survey and these observations were recorded, but no detailed measurements of lane or shoulder width were taken. The estimated FFS were measured using the survey vehicle's speedometer and observing local traffic.

As discussed in Section 2.3, it is necessary to adjust capacity figures to represent the prevailing conditions during inclement weather. Based on limited empirical data, weather conditions such as heavy rain reduce the values of free speed and of highway capacity by approximately 10 percent. Over the last decade new studies have been made on the effects of rain on traffic capacity. These studies indicate a range of effects between 5 and 20 percent depending on wind speed and precipitation rates.

Given the rural character of the EPZ and its sparse population, congestion arising from evacuation is likely to exist only at intersections where evacuation routes merge or cross. Estimates of roadway capacity must be determined with great care. Because of its importance, a brief discussion of the major factors that influence highway capacity is presented in this section.

### Capacity Estimations on Approaches to Intersections

At-grade intersections are apt to become the first bottleneck locations under local heavy traffic volume conditions. This characteristic reflects the need to allocate access time to the respective competing traffic streams by exerting some form of control. During evacuation, control at critical intersections will often be provided by traffic control personnel assigned for that purpose, whose directions may supersede traffic control devices. The Traffic Management Plan (Appendix G) identifies these locations (called Traffic Control Points, TCP) and the management procedures applied.

The per-lane capacity of an approach to a signalized intersection can be expressed (simplistically) in the following form:

$$Q_{cap,m} = \left( \frac{3600}{h_m} \right) \cdot \left[ \frac{G-L}{C} \right]_m = \left( \frac{3600}{h_m} \right) \cdot P_m$$

where:

- $Q_{cap,m}$  = Capacity of a single lane of traffic on an approach, which executes movement,  $m$ , upon entering the intersection; vehicles per hour (vph)
- $h_m$  = Mean queue discharge headway of vehicles on this lane that are executing movement,  $m$ ; seconds per vehicle
- $G$  = The mean duration of GREEN time servicing vehicles that are executing movement,  $m$ , for each signal cycle; seconds
- $L$  = The mean "lost time" for each signal phase servicing movement,  $m$ ; seconds
- $C$  = The duration of each signal cycle; seconds
- $P_m$  = The proportion of GREEN time allocated for vehicles executing movement,  $m$ , from this lane. This value is specified as part of the control treatment.
- $m$  = The movement executed by vehicles after they enter the intersection: through, left-turn, right-turn, and diagonal.



The turn-movement-specific mean discharge headway  $h_m$ , depends in a complex way upon many factors: roadway geometrics, turn percentages, the extent of conflicting traffic streams, the control treatment, and others. A primary factor is the value of "saturation queue discharge headway",  $h_{sat}$ , which applies to through vehicles that are not impeded by other conflicting traffic streams. This value, itself, depends upon many factors including motorist behavior. Formally, we can write,

$$h_m = f_m (h_{sat}, F_1, F_2, \dots)$$

where:

- $h_{sat}$  = Saturation discharge headway for through vehicles; seconds per vehicle
- $F_1, F_2$  = The various known factors influencing  $h_m$
- $f_m (\cdot)$  = Complex function relating  $h_m$  to the known (or estimated) values of  $h_{sat}, F_1, F_2, \dots$

The estimation of  $h_m$  for specified values of  $h_{sat}, F_1, F_2, \dots$  is undertaken within the PC-DYNEV simulation model and within the TRAD model by a mathematical model<sup>1</sup>. The resulting values for  $h_m$  always satisfy the condition:

$$h_m \geq h_{sat}$$

That is, the turn-movement-specific discharge headways are always greater than, or equal to the saturation discharge headway for through vehicles. These headways (or its inverse equivalent, "saturation flow rate"), may be determined by observation or using the procedures of the Highway Capacity Manual.

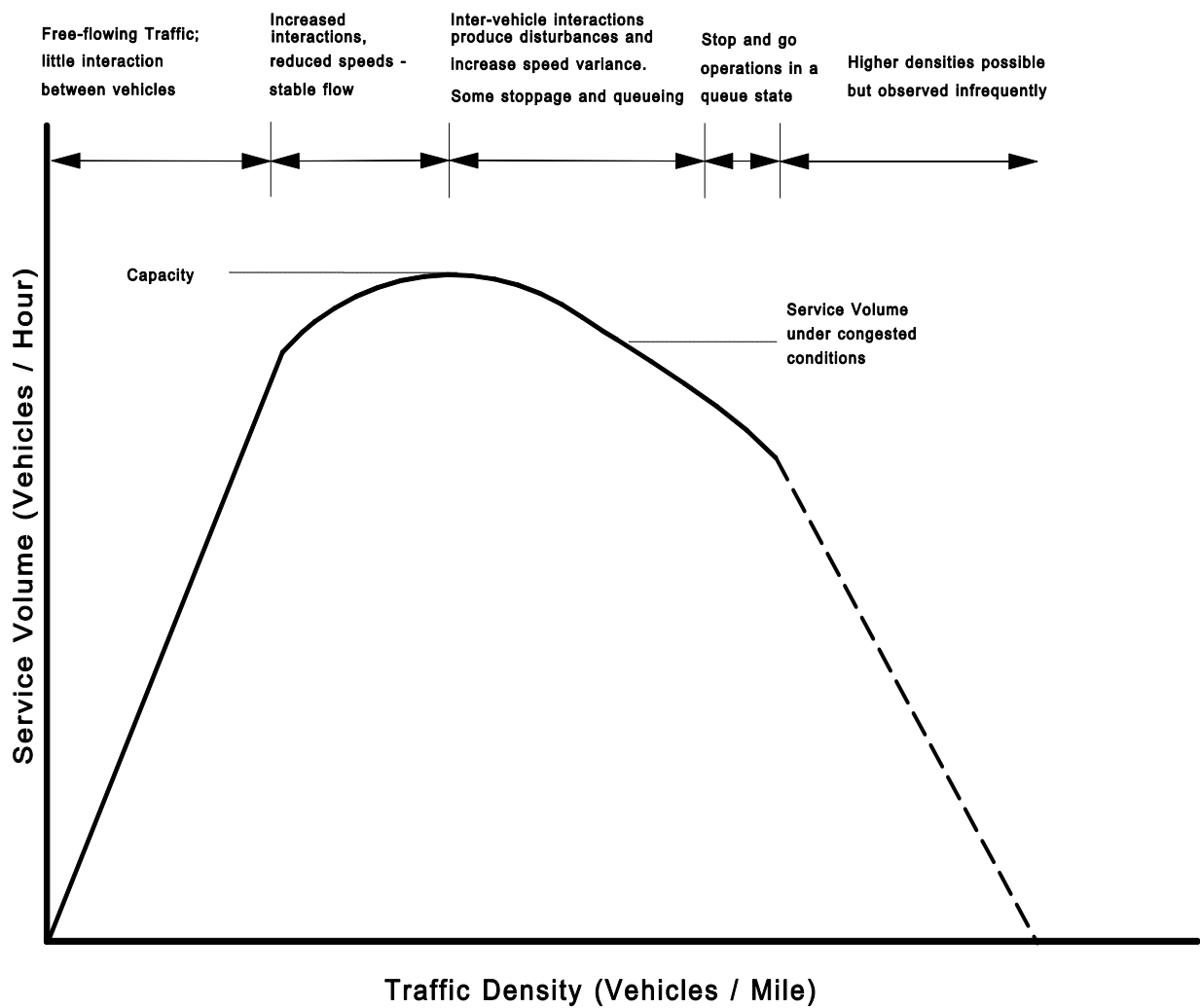
The above discussion is necessarily brief given the scope of this ETE report and the complexity of the subject of intersection capacity. In fact, the two longest chapters in the HCM (16 and 17), each well over 100 pages, address this topic. The factors,  $F_1, F_2, \dots$ , influencing saturation flow rate are identified in equation (16-4) and Exhibit 16-7 of the HCM; Exhibit 10-12 identifies the required data and Exhibit 10-7 presents representative values of Service Volume.

### Capacity Estimation Along Sections of Highway

The capacity of highway sections – as distinct from approaches to intersections – is a function of roadway geometrics, traffic composition (e.g. percent heavy trucks and buses in the traffic stream) and, of course, motorist behavior. There is a fundamental relationship which relates service volume (i.e. the number of vehicles serviced within a uniform highway section in a given time period) to traffic density. Figure 4-1 describes this relationship.

---

<sup>1</sup> Lieberman, E., "Determining Lateral Deployment of Traffic on an Approach to an Intersection", McShane, W. & Lieberman, E., "Service Rates of Mixed Traffic on the far Left Lane of an Approach". Both papers appear in Transportation Research Record 772, 1980.



**Figure 4-1. Fundamental Relationship Between Volume and Density**

As indicated, there are two flow regimes: (1) Free Flow (left side of curve); and (2) Forced Flow (right side). In the Free Flow regime, the traffic demand is fully serviced; this service volume increases as demand volume and density increase, until the service volume attains its maximum value, which is the capacity of the highway section. As traffic demand and the resulting highway density increase beyond this "critical" value, the rate at which traffic can be serviced (i.e. the service volume) can actually decline below capacity. Therefore, in order to realistically represent traffic performance during congested conditions (i.e. when demand exceeds capacity), it is necessary to estimate the service volume,  $V_F$ , under congested conditions.

The value of  $V_F$  can be expressed as:

$$V_F = R \times \text{Capacity}$$

where  $R$  = Reduction factor which is less than unity.

We have employed a value of  $R=0.85$ . The advisability of such a reduction factor is based upon empirical studies that identified a fall-off in the service flow rate when congestion occurs at "bottlenecks" or "choke points" on a freeway system. Zhang and Levinson<sup>2</sup> describe a research program that collected data from a computer-based surveillance system (loop detectors) installed on the Interstate Highway System, at 27 active bottlenecks in the twin cities metro area in Minnesota over a 7-week period. When flow breakdown occurs, queues are formed which discharge at lower flow rates than the maximum capacity prior to observed breakdown. These queue discharge flow (QDF) rates vary from one location to the next and also vary by day of week and time of day based upon local circumstances. The cited reference presents a mean QDF of 2,016 passenger cars per hour per lane (pcphpl). This figure compares with the nominal capacity estimate of 2,250 pcphpl estimated for the ETE and indicated in Appendix K for freeway links. The ratio of these two numbers is 0.896 which translates into a reduction factor of 0.90. The data collected in the cited reference indicates that the variation of QDF at a location is generally in the range of +/- 5% about the average QDF. That is, the lower tail of this distribution would be equivalent to a reduction factor of  $0.90 - 0.05 = 0.85$  which is the figure adopted.

It is seen that a conservative view is taken in estimating the capacity at bottlenecks when congestion develops (this capacity, of course, is the QDF rate discussed above). One could argue that a more representative value for this reduction factor could be 0.90 as discussed above. Given the emergency conditions, a conservative stance is justified. Therefore, a factor of 0.85 is applied only when flow breaks down, as determined by the simulation model.

Rural roads, like freeways, are classified as "uninterrupted flow" facilities. (This is in contrast with urban street systems which have closely spaced signalized intersections and are classified as "interrupted flow" facilities.) As such, traffic flow along rural roads is subject to the same effects as freeways in the event traffic demand exceeds the nominal

---

<sup>2</sup>Lei Zhang and David Levinson, "Some Properties of Flows at Freeway Bottlenecks," Transportation Research Record 1883, 2004.

capacity, resulting in queuing and lower QDF rates. As a practical matter, rural roads rarely break down at locations away from intersections. The breakdowns on rural roads which are experienced on this network occur at intersections where other model logic applies. Therefore, the application of a factor of 0.85 is appropriate on rural roads but rarely, if ever, activated.

The estimated value of capacity is based primarily upon the type of facility and on roadway geometrics. Sections of roadway with adverse geometrics are characterized by lower free-flow speeds and lane capacity. Table 12-15 in the Highway Capacity Manual was referenced to estimate saturation flow rates. The impact of narrow lanes and shoulders on free-flow speed and on capacity is not material, particularly when flow is predominantly in one direction.

The procedure used here was to estimate "section" capacity,  $V_E$ , based on observations made traveling over each section of the evacuation network, by the posted speed limits and travel behavior of other motorists and by reference to the Highway Capacity Manual 2000. It was then determined for each highway section, represented as a network link, whether its capacity would be limited by the "section-specific" service volume,  $V_E$ , or by the intersection-specific capacity. For each link, the model selects the lower value of capacity.

#### Application to the South Texas Project (STP) EPZ

As part of the development of the STP EPZ traffic network, an estimate of roadway capacity is required. The source material for the capacity estimates presented herein is contained in:

2000 Highway Capacity Manual (HCM)  
Transportation Research Board  
National Research Council  
Washington, D.C.

The highway system in the STP EPZ consists primarily of two categories of roads and, of course, intersections:

- Two-lane roads: Local, State
- Multi-lane State Highways (at-grade)

Each of these classifications will be discussed.

### Two-Lane Roads

Ref: HCM Chapters 12 and 20

Two lane roads comprise the majority of highways within the EPZ. The per-lane capacity of a two-lane highway is estimated at 1700 passenger cars per hour (pc/h). This estimate is essentially independent of the directional distribution of traffic volume except that, for extended distances, the two-way capacity will not exceed 3200 pc/h. The HCM procedures then estimate LOS and Average Travel Speed. The evacuation simulation model accepts the specified value of capacity as input and computes average speed based on the time-varying demand:capacity relations.

Based on the field survey and on expected traffic operations associated with evacuation scenarios, most sections of two-lane roads within the EPZ are classified as “Class I”, with “level terrain”; some are “rolling terrain”.

### Multi-Lane Highway

Ref: HCM Chapters 12 and 21

Exhibit 21-23 (in the HCM) presents a set of curves that indicates a per-lane capacity of approximately 2100 pc/h, for free-speeds of 55-60 mph. Based on observation, the multi-lane highways outside of urban areas within the EPZ, service traffic with free-speeds in this range. The actual time-varying speeds computed by the simulation model reflect the demand:capacity relationship and the impact of control at intersections.

Chapter 12 presents the basic concepts underlying the procedures in Chapters 20 and 21.

### Intersections

Ref: HCM Chapters 10, 16, 17

Procedures for estimating capacity and LOS for approaches to intersections are presented in Chapters 16 (signalized intersections) and 17 (un-signalized intersections). These are the two longest chapters in the HCM 2000, reflecting the complexity of these procedures. The simulation logic is likewise complex, but different; as stated on page 31-21 of the HCM 2000:

*“Assumptions and complex theories are used in the simulation model to represent the real-world dynamic traffic environment.”*

## Simulation and Capacity Estimation

Chapter 31 of the HCM is entitled, “Simulation and other Models.” The lead sentence on the subject of Traffic Simulation Models is:

Traffic simulation models use numerical techniques on a digital computer to create a description of how traffic behaves over extended periods of time for a given transportation facility or system...by stepping through time and across space, tracking events as the system state unfolds. Traffic simulation models focus on the dynamic of traffic flow.

In general terms, this description applies to the PC-DYNEV model, which is further described in Appendix C. It is essential to recognize that simulation models do not replicate the methodology and procedures of the HCM – they *replace* these procedures by describing the complex interactions of traffic flow and computing Measures of Effectiveness (MOE) detailing the operational performance of traffic over time and by location.

All simulation models must be calibrated properly with field observations that quantify the performance parameters applicable to the analysis network. Two of the most important of these are: (1) Free flow speed (FFS); and (2) saturation headway,  $h_{sat}$ . The first of these is estimated by direct observation during the road survey; the second is estimated using the concepts of the HCM, as described earlier. These parameters are listed in Appendix K, for each network link.

## 5. ESTIMATION OF TRIP GENERATION TIME

Federal Government guidelines (see NUREG-0654, Appendix 4) specify that the planner estimate the distributions of elapsed times associated with mobilization activities undertaken by the public to prepare for the evacuation trip. The elapsed time associated with each activity is represented as a statistical distribution reflecting differences between members of the public. The quantification of these activity-based distributions relies largely on the results of the telephone survey. We define the sum of these distributions of elapsed times as the Trip Generation Time Distribution.

### Background

In general, an accident at a nuclear power station is characterized by the following Emergency Action Classification Levels (see Appendix 1 of NUREG-0654 for details):

1. Unusual Event
2. Alert
3. Site Area Emergency
4. General Emergency

At each level, the Federal guidelines specify a set of Actions to be undertaken by the Licensee, and by State and Local offsite authorities. As a Planning Basis, we will adopt a conservative posture, in accord with Federal Regulations, that a rapidly escalating accident will be considered in calculating the Trip Generation Time. We will assume:

- a. The Advisory to Evacuate will be announced coincident with the emergency notification.
- b. Mobilization of the general population will commence up to 10 minutes after the alert notification.
- c. Evacuation Time Estimates (ETE) are measured relative to the Advisory to Evacuate.
- d. Schools will be evacuated prior to the Advisory to Evacuate, if possible.

We emphasize that the adoption of this planning basis is not a representation that these events will occur at STP within the indicated time frame. Rather, these assumptions are necessary in order to:

- Establish a temporal framework for estimating the Trip Generation distribution in the format recommended in Appendix 4 of NUREG-0654.
- Identify temporal points of reference that uniquely define "Clear Time" and ETE.

It is more likely that a longer time will elapse between the various classes of an emergency at STP.

For example, suppose one hour will elapse from the siren alert to the Advisory to Evacuate. In this case, it is reasonable to expect some degree of spontaneous evacuation and the start of mobilization activities by the public during this one-hour period. As a result, the population within the Emergency Planning Zone (EPZ) will be lower when the Advisory to Evacuate is announced, than at the time of the General Emergency. Thus, the time needed to evacuate the EPZ, after the Advisory to Evacuate will be less than the estimates presented in this report.

The notification process consists of two events:

- Transmitting information (e.g. using sirens, tone alerts, EAS broadcasts, loud speakers).
- Receiving and correctly interpreting the information that is transmitted.

The peak population within the EPZ approximates 6,850 persons (residents, employees, and transients) who are deployed over an area of approximately 314 square miles and engaged in a wide variety of activities. It must be anticipated that some time will elapse between the transmission and receipt of the information advising the public of an accident.

The amount of elapsed time will vary from one individual to the next depending where that person is, what that person is doing, and related factors. Furthermore, some persons who will be directly involved with the evacuation process may be outside the EPZ at the time that the emergency is declared. These people may be commuters, shoppers and other travelers who reside within the EPZ and who will return to join the other household members upon receiving notification of an emergency.

As indicated in NUREG-0654, the estimated elapsed times for the receipt of notification can be expressed as a distribution reflecting the different notification times for different people within, and outside, the EPZ. By using time distributions, it is also possible to distinguish between different population groups and different day-of-week and time-of-day scenarios, so that accurate ETE may be obtained.

For example, people at home or at work within the EPZ will be notified by siren, and/or tone alert and/or radio. Those well outside the EPZ will be notified by telephone, radio, TV and word-of-mouth, with potentially longer time lags. Furthermore, the spatial distribution of the EPZ population will differ with time of day - families will be united in the evenings, but dispersed during the day. In this respect, weekends will differ from weekdays.



Generally, the information required can be obtained from a telephone survey of EPZ residents. Such a survey was conducted. Appendix F presents the survey results. It is important to note that the shape and duration of the evacuation trip mobilization distribution is important at sites where traffic congestion is not expected to cause the evacuation time estimate to extend in time well beyond the trip generation period. The remaining discussion will focus on the application of the trip generation data obtained from the telephone survey, to the development of the STP ETE.

### Fundamental Considerations

The environment leading up to the time that people begin their evacuation trips consists of a sequence of events and activities. Each event (other than the first) occurs at an instant in time and is the outcome of an activity.

Activities are undertaken over a period of time. Activities may be in "series" (i.e. to undertake an activity implies the completion of all preceding events) or may be in parallel (two or more activities may take place over the same period of time). Activities conducted in series are functionally dependent on the completion of prior activities; activities conducted in parallel are functionally independent of one-another. The relevant events associated with the public's preparation for evacuation are:

<u>Event Number</u>	<u>Event Description</u>
1	Notification
2	Aware of situation
3	Depart work
4	Arrive home
5	Depart on evacuation trip

Associated with each sequence of events are one or more activities, as outlined below:

<b>Table 5-1. Event Sequence for Evacuation Activities</b>		
<b>Event Sequence</b>	<b>Activity</b>	<b>Distribution</b>
1 → 2	Receive notification	1
2 → 3	Prepare to leave work	2
2,3 → 4	Travel home	3
2,4 → 5	Prepare to leave to evacuate	4

These relationships are shown graphically in Figure 5-1.

- An Event is a 'state' that exists at a point in time (e.g., depart work, arrive home)
- An Activity is a 'process' that takes place over some elapsed time (e.g., prepare to leave work, travel home)

As such, an Activity changes the 'state' of an individual (e.g. the activity, 'travel home' changes the state from 'depart work' to 'arrive home'). Therefore, an Activity can be described as an 'Event Sequence'; the elapsed times to perform an event sequence vary from one person to the next and are described as statistical distributions on the following pages.

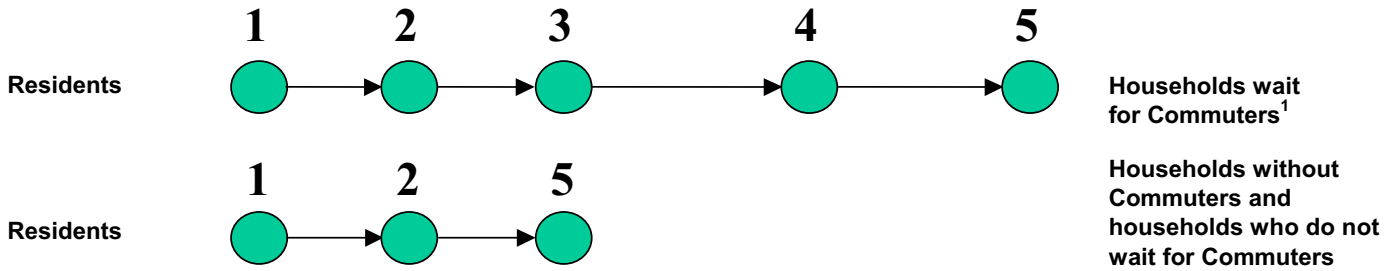
An employee who lives outside the EPZ will follow sequence (c) of Figure 5-1. A household within the EPZ that has one or more commuters at work, and will await their return before beginning the evacuation trip will follow the first sequence of Figure 5-1(a). A household within the EPZ that has no commuters at work, or that will not await the return of any commuters, will follow the second sequence of Figure 5-1(a), regardless of day of week or time of day.

Households with no commuters on weekends or in the evening/night-time, will follow the applicable sequence in Figure 5-1(b). Transients will always follow one of the sequences of Figure 5-1(b). Some transients away from their residence could elect to evacuate immediately without returning to the residence, as indicated in the second sequence.

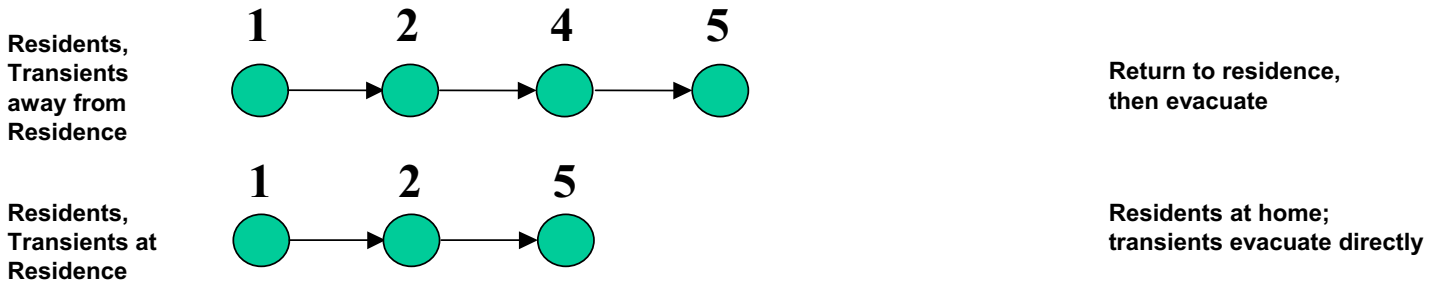
It is seen from Figure 5-1, that the Trip Generation time (i.e. the total elapsed time from Event 1 to Event 5) depends on the scenario and will vary from one household to the next. Furthermore, Event 5 depends, in a complicated way, on the time distributions of all activities preceding that event. That is, to estimate the time distribution of Event 5, we must obtain estimates of the time distributions of all preceding events.

#### Estimated Time Distributions of Activities Preceding Event 5

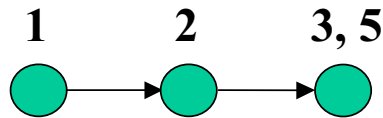
The time distribution of an event is obtained by "summing" the time distributions of all prior contributing activities. (This "summing" process is quite different than an algebraic sum since we are operating on distributions – not scalar numbers).



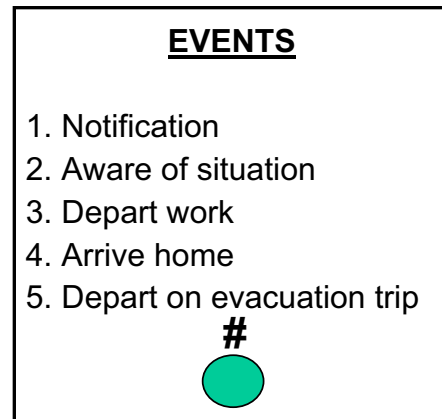
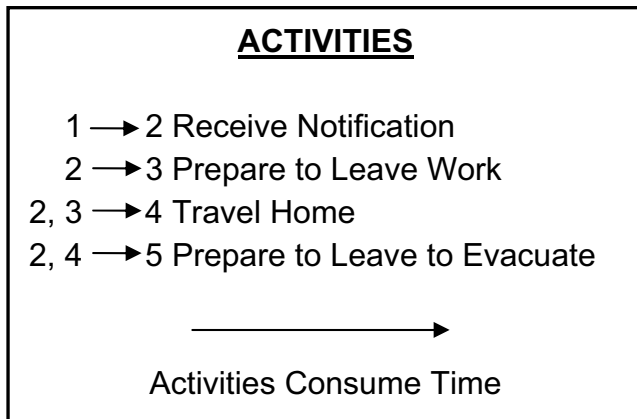
**(a) Accident occurs during midweek, at midday; year round**



**(b) Accident occurs during weekend or during the evening<sup>2</sup>**



**(c) Employees who live outside the EPZ**



<sup>1</sup> Applies for evening and weekends also if commuters are at work.

<sup>2</sup> Applies throughout the year for transients.

**Figure 5-1. Events and Activities Preceding the Evacuation Trip**

Time Distribution No. 1, Becoming Aware of Accident: Activity 1 → 2

It is reasonable to expect that 85 percent of those within the EPZ will be aware of the accident within 30 minutes with the remainder notified within the following 20 minutes. This distribution is given below:

Distribution No. 1, Notification Time: Activity 1 → 2

It is assumed that 85 percent of those within the EPZ will be aware of the accident within 30 minutes with the remainder notified within the following 20 minutes. The notification distribution is given below:

<b>Elapsed Time (Minutes)</b>	<b>Percent of Population Notified</b>
0	0
5	7
10	13
15	26
20	46
25	65
30	85
35	90
40	95
45	98
50	100

Distribution No. 2, Prepare to Leave Work: Activity 2 → 3

It is reasonable to expect that the business enterprises within the EPZ will elect to shut down following notification and most employees would leave work quickly. Commuters, who work outside the EPZ could, in all probability, also leave quickly since facilities outside the EPZ would remain open and other personnel would remain. Personnel or farmers responsible for equipment would require additional time to secure their facility. The distribution of Activity 2 → 3 reflects data obtained by the telephone survey. This distribution is plotted in Figure 5-2 and listed below.

<b>Table 5-3. Time Distribution for Employees to Prepare to Leave Work</b>	
<b>Elapsed Time (Minutes)</b>	<b>Cumulative Percent Employees Leaving Work</b>
0	0
5	0
10	32
15	48
20	57
25	63
30	66
35	77
40	80
45	81
50	84
55	85
60	85
65	91
70	93
75	94
80	96
85	98
90	99
95	100

NOTE: The survey data was normalized to distribute the "Don't know" response. That is, the sample was reduced in size to include only those returns which included responses to this question. The underlying assumption is that the distribution of this activity for the "Don't know" responders, if the event takes place, would be the same as those responders who provided estimates.

Distribution No. 3, Travel Home: Activity 3 → 4

These data are provided directly by the telephone survey. This distribution is plotted in Figure 5-2 and listed below.

<b>Table 5-4. Time Distribution for Commuters to Travel Home</b>	
<b>Elapsed Time (Minutes)</b>	<b>Cumulative Percent Returning Home</b>
0	0
5	0
10	22
15	40
20	54
25	65
30	70
35	83
40	85
45	87
50	91
55	92
60	92
65	95
70	95
75	96
80	96
85	98
90	99
95	100

NOTE: The survey data was normalized to distribute the "Don't know" response

Distribution No. 4, Prepare to Leave Home: Activity 2, 4 → 5

These data are provided directly by the telephone survey. This distribution is plotted in Figure 5-2 and listed below.

<b>Table 5-5. Time Distribution for Population to Prepare to Evacuate</b>					
<b>Elapsed Time (Minutes)</b>	<b>Cumulative Pct. Ready to Evacuate</b>	<b>Elapsed Time (Minutes)</b>	<b>Cumulative Pct. Ready to Evacuate</b>	<b>Elapsed Time (Minutes)</b>	<b>Cumulative Pct. Ready to Evacuate</b>
0	0	95	70	190	89
5	0	100	71	195	90
10	4	105	71	200	91
15	9	110	71	205	91
20	13	115	73	210	91
25	19	120	74	215	91
30	25	125	76	220	92
35	31	130	78	225	92
40	34	135	81	230	92
45	36	140	84	235	92
50	38	145	84	240	93
55	44	150	84	245	93
60	50	155	85	250	94
65	56	160	85	255	95
70	60	165	85	260	97
75	64	170	85	265	98
80	67	175	86	270	99
85	68	180	87	275	100
90	69	185	88		

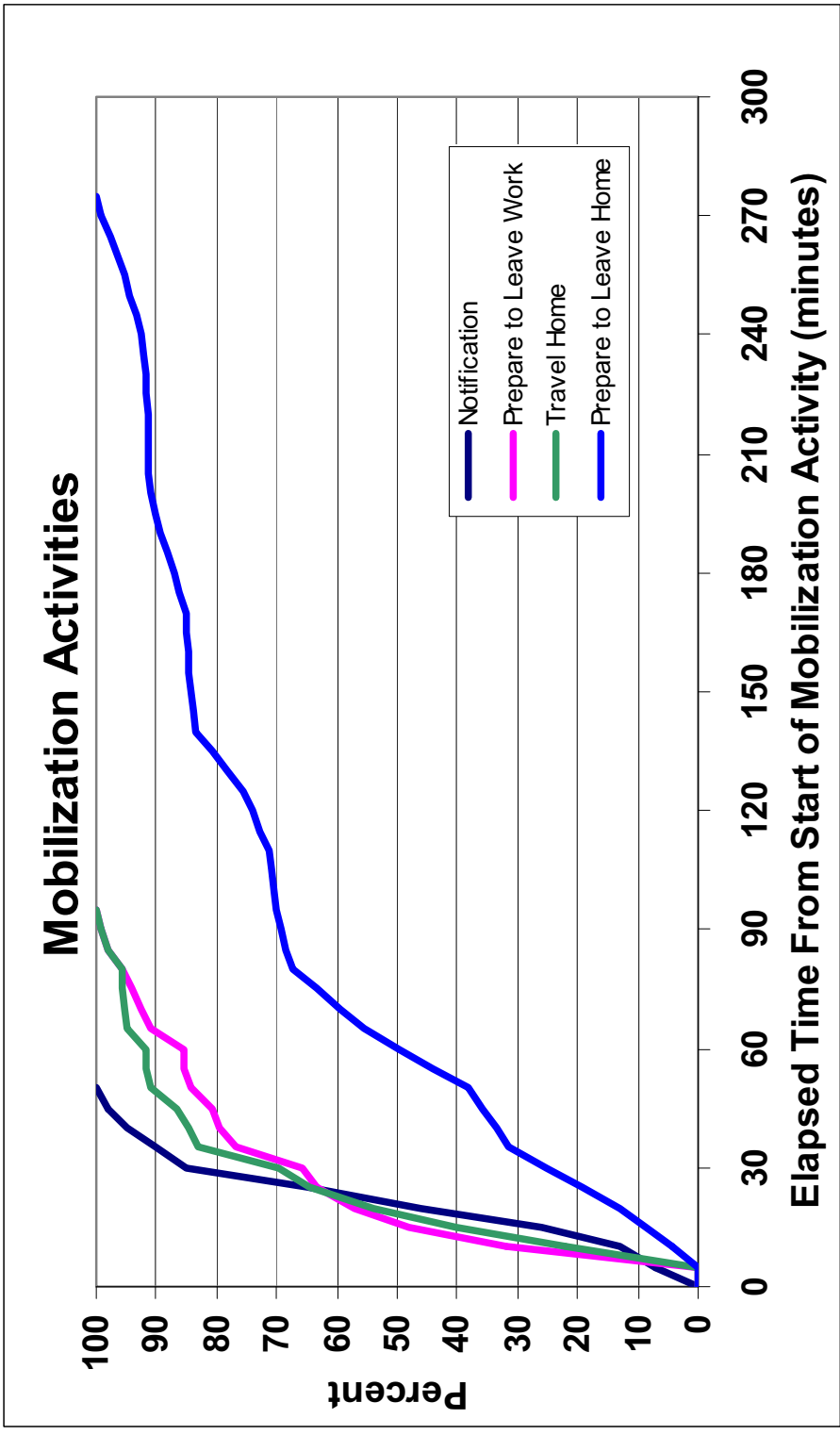


Figure 5-2. Evacuation Mobilization Activities



### Calculation of Trip Generation Time Distribution

The time distributions for each of the mobilization activities presented herein must be combined to form the appropriate Trip Generation Distributions. We assume that the stated events take place in sequence such that all preceding events must be completed before the current event can occur. For example, if a household awaits the return of a commuter, the work-to-home trip (Activity 3 → 4) must precede Activity 4 → 5.

To calculate the time distribution of an event that is dependent on two sequential activities, it is necessary to “sum” the distributions associated with these prior activities. The distribution summing algorithm is applied repeatedly as shown to form the required distribution. As an outcome of this procedure, new time distributions are formed; we assign “letter” designations to these intermediate distributions to describe the procedure.

<b>Table 5-6. Mapping Distributions to Events</b>		
<b>Apply “Summing” Algorithm To:</b>	<b>Distribution Obtained</b>	<b>Event Defined</b>
Distributions 1 and 2	Distribution A	Event. 3
Distributions A and 3	Distribution B	Event. 4
Distributions B and 4	Distribution C	Event. 5
Distributions 1 and 4	Distribution D	Event. 5

Distributions A through D are described below; distributions A, C, and D are shown in Figure 5-3:

<b>Table 5-7. Description of the Distributions</b>	
Distribution	Description
A	Time distribution of commuters departing place of work (Event 3). Also applies to employees who work within the EPZ who live outside, and to Transients within the EPZ.
B	Time distribution of commuters arriving home (Event 4).
C	Time distribution of residents with commuters leaving home to begin the evacuation trip (Event 5).
D	Time distribution of residents without commuters returning home to begin the evacuation trip (Event 5).

Figure 5-3 presents the combined trip generation distributions designated A, C, and D. These distributions are presented on the same time scale. The PC-DYNEV simulation model is designed to accept varying rates of vehicle trip generation for each origin centroid, expressed in the form of histograms. These histograms, which represent Distributions A, C, and D, properly displaced with respect to one another, are tabulated in Table 5-8 (Distribution B, Arrive Home, omitted for clarity).

The final time period (12) in Table 5-8 is 900 minutes long. This time period is added to allow the analysis network to clear, in the event congestion persists beyond the trip generation period. Note that there are no trips generated during this final time period.

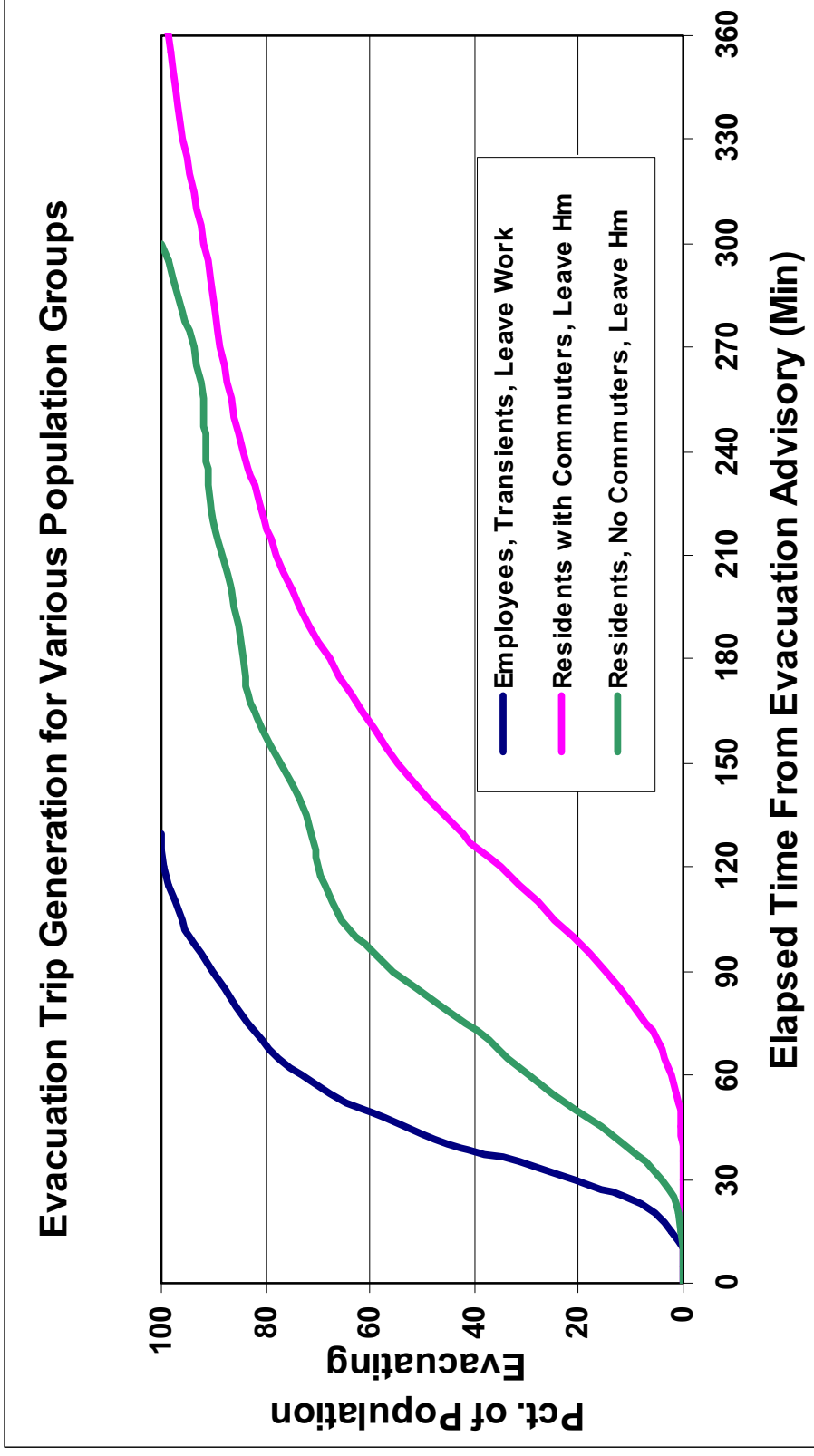


Figure 5-3. Comparison of Trip Generation Distributions

Table 5-8. Trip Generation for the EPZ Population					
Time Period	Duration (Min)	Percent of Total Trips Generated Within Indicated Time Period			
		Residents With Commuters (Distribution C)	Residents Without Commuters (Distribution D)	Employees* (Distribution A)	Transients (Distribution A)
1	15	0	0	2	2
2	15	0	4	23	19
3	15	0	14	65	32
4	15	2	12	10	20
5	30	13	25	0	17
6	30	20	15	0	10
7	30	20	7	0	0
8	30	13	7	0	0
9	60	16	7	0	0
10	60	8	9	0	0
11	60	8	0	0	0
12	900	0	0	0	0

\* The distribution from the telephone survey results was modified based on discussions with STP Emergency Planning Personnel. Nearly all of the employment in the EPZ is at STP; the modified distribution shown is based on data from STP emergency drills.

## 6. DEMAND ESTIMATION FOR EVACUATION SCENARIOS

An evacuation “case” defines a combination of Evacuation Region and Evacuation Scenario. The definitions of “Region” and “Scenario” are as follows:

- Region        A grouping of contiguous evacuation Zones, that forms either a “keyhole” sector-based area, or a circular area within the EPZ, that must be evacuated in response to a radiological emergency.
- Scenario      A combination of circumstances, including time of day, day of week, season, and weather conditions. Scenarios define the number of people in each of the affected population groups and their respective mobilization time distributions.

The Zones are identified in Figure 6-1. Using the Zone information provided by STP personnel (Table 6-1), a total of 22 distinct Regions were defined, which encompass all the groupings of Zones considered. The regions are detailed in Table 6-2. Each keyhole consists of a circular area centered at the South Texas Project (STP) and an adjoining sector with a central angle of 10 degrees. These sectors extend to a distance of 5 miles from STP (Regions R04 to R10), or to the EPZ boundary (Regions R11 to R22). The wind direction defines the orientation of these Regions. Regions 1, 2 and 3 are circular areas centered at STP with radii of 2, 5 and 10 miles, respectively.

A total of 12 Scenarios were evaluated for all Regions. Thus, there are a total of  $12 \times 22 = 264$  evacuation cases. Table 6-3 is a description of all Scenarios.

Each combination of region and scenario implies a specific population to be evacuated. Table 6-4 presents the percentage of each population group assumed to evacuate for each scenario. Table 6-5 presents the vehicle counts for each scenario.

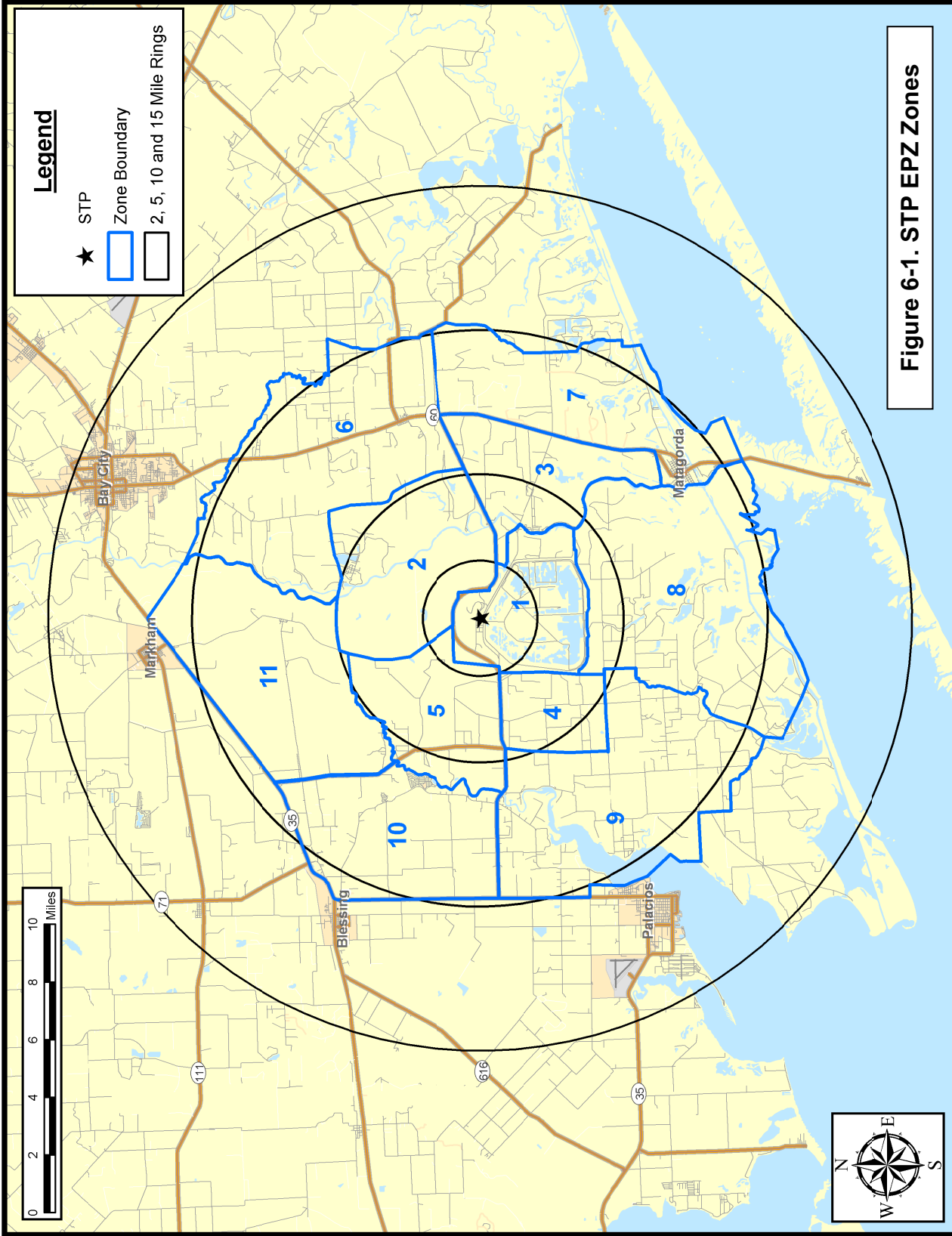


Figure 6-1. STP EPZ Zones

Table 6-1. Definition of Evacuation Regions

WIND DIRECTION FROM IS BETWEEN	EVACUATE ZONES					EVACUATE KEY HOLE ZONES				
	2 Mile Radius	KLD REGION	5 Mile Radius	KLD REGION	10 Mile Radius	KLD REGION	2 Mile Radius & 5 Miles Downwind	KLD REGION	5 Mile Radius and 10 Miles Downwind	KLD REGION
35° to 5°	1	R1	1,2,3,4,5	R2	1,2,3,4,5,6,7,8,9,10,11	R3	1	R1	1,2,3,4,5,8,9	R11
6° to 16°	1	R1	1,2,3,4,5	R2	1,2,3,4,5,6,7,8,9,10,11	R3	1	R1	1,2,3,4,5,8,9	R11
17° to 28°	1	R1	1,2,3,4,5	R2	1,2,3,4,5,6,7,8,9,10,11	R3	1	R1	1,2,3,4,5,8,9	R11
29° to 39°	1	R1	1,2,3,4,5	R2	1,2,3,4,5,6,7,8,9,10,11	R3	1,4	R4	1,2,3,4,5,8,9	R11
40° to 50°	1	R1	1,2,3,4,5	R2	1,2,3,4,5,6,7,8,9,10,11	R3	1,4	R4	1,2,3,4,5,8,9	R11
51° to 61°	1	R1	1,2,3,4,5	R2	1,2,3,4,5,6,7,8,9,10,11	R3	1,4,5	R5	1,2,3,4,5,8,9,10	R12
62° to 73°	1	R1	1,2,3,4,5	R2	1,2,3,4,5,6,7,8,9,10,11	R3	1,4,5	R5	1,2,3,4,5,9,10	R13
74° to 84°	1	R1	1,2,3,4,5	R2	1,2,3,4,5,6,7,8,9,10,11	R3	1,4,5	R5	1,2,3,4,5,9,10	R13
85° to 95°	1	R1	1,2,3,4,5	R2	1,2,3,4,5,6,7,8,9,10,11	R3	1,4,5	R5	1,2,3,4,5,9,10	R13
96° to 106°	1	R1	1,2,3,4,5	R2	1,2,3,4,5,6,7,8,9,10,11	R3	1,4,5	R5	1,2,3,4,5,9,10,11	R14
107° to 118°	1	R1	1,2,3,4,5	R2	1,2,3,4,5,6,7,8,9,10,11	R3	1,5	R6	1,2,3,4,5,9,10,11	R14
119° to 129°	1	R1	1,2,3,4,5	R2	1,2,3,4,5,6,7,8,9,10,11	R3	1,5	R6	1,2,3,4,5,9,10,11	R14
130° to 140°	1	R1	1,2,3,4,5	R2	1,2,3,4,5,6,7,8,9,10,11	R3	1,5	R6	1,2,3,4,5,10,11	R15
141° to 151°	1	R1	1,2,3,4,5	R2	1,2,3,4,5,6,7,8,9,10,11	R3	1,2,5	R7	1,2,3,4,5,10,11	R15
152° to 163°	1	R1	1,2,3,4,5	R2	1,2,3,4,5,6,7,8,9,10,11	R3	1,2,5	R7	1,2,3,4,5,10,11	R15
164° to 174°	1	R1	1,2,3,4,5	R2	1,2,3,4,5,6,7,8,9,10,11	R3	1,2,5	R7	1,2,3,4,5,6,10,11	R16
175° to 185°	1	R1	1,2,3,4,5	R2	1,2,3,4,5,6,7,8,9,10,11	R3	1,2	R8	1,2,3,4,5,6,11	R17
186° to 196°	1	R1	1,2,3,4,5	R2	1,2,3,4,5,6,7,8,9,10,11	R3	1,2	R8	1,2,3,4,5,6,11	R17
197° to 208°	1	R1	1,2,3,4,5	R2	1,2,3,4,5,6,7,8,9,10,11	R3	1,2	R8	1,2,3,4,5,6,11	R17
209° to 219°	1	R1	1,2,3,4,5	R2	1,2,3,4,5,6,7,8,9,10,11	R3	1,2	R8	1,2,3,4,5,6,11	R17
220° to 230°	1	R1	1,2,3,4,5	R2	1,2,3,4,5,6,7,8,9,10,11	R3	1,2	R8	1,2,3,4,5,6	R18
231° to 241°	1	R1	1,2,3,4,5	R2	1,2,3,4,5,6,7,8,9,10,11	R3	1,2,3	R9	1,2,3,4,5,6,7	R19
242° to 253°	1	R1	1,2,3,4,5	R2	1,2,3,4,5,6,7,8,9,10,11	R3	1,2,3	R9	1,2,3,4,5,6,7	R19
254° to 264°	1	R1	1,2,3,4,5	R2	1,2,3,4,5,6,7,8,9,10,11	R3	1,2,3	R9	1,2,3,4,5,6,7	R19
265° to 275°	1	R1	1,2,3,4,5	R2	1,2,3,4,5,6,7,8,9,10,11	R3	1,2,3	R9	1,2,3,4,5,6,7	R19
276° to 286°	1	R1	1,2,3,4,5	R2	1,2,3,4,5,6,7,8,9,10,11	R3	1,2,3	R9	1,2,3,4,5,6,7	R19
287° to 298°	1	R1	1,2,3,4,5	R2	1,2,3,4,5,6,7,8,9,10,11	R3	1,3	R10	1,2,3,4,5,7	R20
299° to 309°	1	R1	1,2,3,4,5	R2	1,2,3,4,5,6,7,8,9,10,11	R3	1,3	R10	1,2,3,4,5,7,8	R21
310° to 320°	1	R1	1,2,3,4,5	R2	1,2,3,4,5,6,7,8,9,10,11	R3	1,3	R10	1,2,3,4,5,7,8	R21
321° to 331°	1	R1	1,2,3,4,5	R2	1,2,3,4,5,6,7,8,9,10,11	R3	1,3	R10	1,2,3,4,5,7,8	R21
332° to 343°	1	R1	1,2,3,4,5	R2	1,2,3,4,5,6,7,8,9,10,11	R3	1	R1	1,2,3,4,5,7,8	R21
344° to 354°	1	R1	1,2,3,4,5	R2	1,2,3,4,5,6,7,8,9,10,11	R3	1	R1	1,2,3,4,5,7,8,9	R22

Table 6-2. Description of Evacuation Regions												
Region	Description	ZONE										
		1	2	3	4	5	6	7	8	9	10	11
R01	2 mile ring											
R02	5-mile ring											
R03	Full EPZ											
Evacuate 2 mile ring and 5 miles downwind												
Region	Wind Direction (From) in Degrees	ZONE										
		1	2	3	4	5	6	7	8	9	10	11
R04	29 - 50											
R05	51 - 106											
R06	107 - 140											
R07	141 - 174											
R08	175 - 230											
R09	231 - 286											
R10	287 - 331											
R01*	332 - 28											
Evacuate 5 mile ring and downwind to EPZ boundary												
Region	Wind Direction (From) in Degrees	ZONE										
		1	2	3	4	5	6	7	8	9	10	11
R11	355 - 50											
R12	51 - 61											
R13	62 - 95											
R14	96 - 129											
R15	130 - 163											
R16	164 - 174											
R17	175 - 219											
R18	220 - 230											
R19	231 - 286											
R20	287 - 298											
R21	299 - 343											
R22	344 - 354											

**Residents and Transients in the Matagorda Beach area are always evacuated.**

\* Note that evacuating the 2-mile ring and evacuating the 5-mile ring with wind from 332° to 28° both result in the evacuation of Region1. Thus, R01 is shown twice in the table above.



<b>Table 6-3. Evacuation Scenario Definitions</b>					
<b>Scenario</b>	<b>Season</b>	<b>Day of Week</b>	<b>Time of Day</b>	<b>Weather</b>	<b>Special</b>
1	Summer	Midweek	Midday	Good	None
2	Summer	Midweek	Midday	Rain	None
3	Summer	Weekend	Midday	Good	None
4	Summer	Weekend	Midday	Rain	None
5	Summer	Midweek, Weekend	Evening	Good	None
6	Winter	Midweek	Midday	Good	None
7	Winter	Midweek	Midday	Rain	None
8	Winter	Weekend	Midday	Good	None
9	Winter	Weekend	Midday	Rain	None
10	Winter	Midweek, Weekend	Evening	Good	None
11	Summer	Weekend	Midday	Good	Holiday (Beachgoers)
12	Summer	Midweek	Midday	Good	New Plant Construction

**Table 6-4. Percent of Population Groups Evacuating for Various Scenarios**

Scenarios	Residents With Commuters in Household	Residents With No Commuters in Household	Employees	Transients	Shadow	Special Event	School Buses	Transit Buses	External Through Traffic
1	49%	51%	96%	75%	49%	0%	10%	100%	100%
2	49%	51%	96%	75%	49%	0%	10%	100%	100%
3	10%	90%	15%	100%	33%	0%	0%	100%	100%
4	10%	90%	15%	100%	33%	0%	0%	100%	100%
5	10%	90%	15%	65%	33%	0%	0%	100%	60%
6	49%	51%	100%	15%	50%	0%	100%	100%	100%
7	49%	51%	100%	15%	50%	0%	100%	100%	100%
8	10%	90%	15%	25%	33%	0%	0%	100%	100%
9	10%	90%	15%	25%	33%	0%	0%	100%	100%
10	10%	90%	15%	10%	33%	0%	0%	100%	60%
11	10%	90%	15%	100%	33%	100%	0%	100%	100%
12	49%	51%	96%	75%	49%	100%	10%	100%	100%

**Resident Households With Commuters** ..... Households of EPZ residents who await the return of commuters prior to beginning the evacuation trip.

**Resident Households With No Commuters** .... Households of EPZ residents who do not have commuters or will not await the return of commuters prior to beginning the evacuation trip.

**Employees** ..... EPZ employees who live outside of the EPZ.

**Transients** ..... People who are in the EPZ at the time of an accident for recreational or other (non-employment) purposes.

**Shadow** ..... Residents and employees in the shadow region (outside of the EPZ) who will spontaneously decide to relocate during the evacuation. The basis for the values shown is a 30% relocation of shadow residents along with a proportional percentage of shadow employees. The percentage of shadow employees is computed using the scenario-specific ratio of EPZ employees to residents. Additional vehicles in the STP area for holiday beach goers for Scenario 11 and for construction workers (building a new unit at STP) for Scenario 12.

**Special Events** ..... Vehicle-equivalents present on the road during evacuation servicing schools and transit-dependent people (1 bus is equivalent to 2 passenger vehicles).

**School and Transit Buses** ..... Traffic on local highways and major arterial roads at the start of the evacuation. This traffic is stopped by access control approximately 90 minutes after the evacuation begins.

**External Through Traffic** ..... Traffic on local highways and major arterial roads at the start of the evacuation. This traffic is stopped by access control approximately 90 minutes after the evacuation begins.

**Table 6-5. Vehicle Estimates By Scenario\***

Scenarios	Residents with Commuters**	Residents without Commuters**	Employees	Transients**	Shadow	Special Events	School Buses ***	Transit Buses ***	External Traffic	Total Scenario Vehicles
1	904	890	1,134	1,955	8,134	-	2	6	900	13,912
2	904	890	1,134	1,955	8,134	-	2	6	900	13,912
3	90	1,704	177	2,607	5,469	-	-	6	900	10,950
4	90	1,704	177	2,607	5,469	-	-	6	900	10,950
5	90	1,704	177	1,695	5,469	-	-	6	900	9,678
6	904	890	1,181	391	8,265	-	22	6	900	12,545
7	904	890	1,181	391	8,265	-	22	6	900	12,545
8	90	1,704	177	652	5,469	-	-	6	900	8,995
9	90	1,704	177	652	5,469	-	-	6	900	8,995
10	90	1,704	177	261	5,469	-	-	6	900	8,244
11	90	1,704	177	2,607	5,469	2,500	-	6	900	10,950
12	904	890	1,134	1,955	8,134	2,475	2	6	900	16,387

**NOTE:**

\*The values presented are for an evacuation of the full EPZ (Region R03)

\*\*Residents and transients at Matagorda Beach are included in these totals for the purpose of calculating ETE. Matagorda Beach is not within the EPZ.

\*\*\* School Buses and Transit Buses are expressed in vehicle equivalents (1 bus= 2 vehicles). Therefore actual number of buses are 1/2 value shown.

## 7. GENERAL POPULATION EVACUATION TIME ESTIMATES (ETE)

This section presents the current results of the computer analyses using the IDYNEV System described in Appendices B, C and D. These results cover 22 regions within the STP EPZ and the 12 Evacuation Scenarios discussed in Section 6.

The ETE for all Evacuation Cases are presented in Tables 7-1A through 7-1D. **These tables present the estimated times to clear the indicated population percentages from the Evacuation Regions for all Evacuation Scenarios.** Table 7-2 defines the Evacuation Regions considered. The tabulated values of ETE are obtained by interpolating the PC-DYNEV simulation model outputs which are generated at 10-minute intervals, then rounding these data to the nearest 5 minutes.

### 7.1 Voluntary Evacuation and Shadow Evacuation

We define “voluntary evacuees” as people who are within the EPZ in Zones for which an Advisory to Evacuate *has not* been issued, yet who nevertheless elect to evacuate. We define “shadow evacuation” as the movement of people from areas *outside* the EPZ for whom no protective action recommendation has been issued. Both voluntary and shadow evacuations are assumed to take place over the same time frame as the evacuation from within the impacted Evacuation Region.

The ETE for STP addresses the issue of voluntary evacuees in the manner shown in Figure 7-1. Within the circle defined by the farthest radial distance of the Evacuation Region, 50 percent of those people located in Zones not advised to evacuate, are assumed to do so. Within the annular ring extending from the furthest distance of the Evacuation Region (if less than 10 miles), to the EPZ boundary, it is assumed that 35 percent of the people located there will elect to evacuate.

Figure 7-2 presents the area identified as the Shadow Evacuation Region. This region extends radially from the boundary of the EPZ to a distance of 15 miles. The population and number of evacuating vehicles in the Shadow Evacuation Region were estimated using the same methodology that was used for permanent residents within the EPZ (see page 3-2). It is estimated that 27,613 people reside in the Shadow Evacuation Region and that they will evacuate in 16,585 vehicles.

Traffic generated within this Shadow Evacuation Region, traveling away from the STP location, has the potential for impeding evacuating vehicles from within the Evacuation Region. We assume that the traffic volumes emitted within the Shadow Evacuation Region correspond to 30 percent of the residents there plus a proportionate number of employees in that region. **All ETE calculations include this shadow traffic movement.**

## 7.2 Patterns of Traffic Congestion During Evacuation

Figures 7-3 and 7-4 illustrate the patterns of traffic congestion that arise for the case when the entire EPZ (Region R03) is advised to evacuate during the summer, weekend, midday period under good weather conditions (Scenario 3).

Traffic congestion, as the term is used here, is defined as Level of Service (LOS) F. LOS F is defined as follows (2000 HCM):

Level of Service F is used to define forced or breakdown flow. This condition exists wherever the amount of traffic approaching a point exceeds the amount that can traverse the point. Queues form behind such locations. Operations within the queue are characterized by stop-and-go waves, and they are extremely unstable. Vehicles may progress at reasonable speeds for several hundred feet or more, then be required to stop in a cyclic fashion. Level of Service F is used to describe the operating conditions within the queue, as well as the point of the breakdown. It should be noted, however, that in many cases operating conditions of vehicles or pedestrians discharged from the queue may be quite good. Nevertheless, it is the point at which arrival flow exceeds discharge flow, which causes the queue to form, and Level of Service F is an appropriate designation for such points.

This definition is general and conceptual in nature, and applies primarily to uninterrupted flow. Levels of Service for interrupted flow facilities vary widely in terms of both the user's perception of service quality and the operational variables used to describe them.

All highway "links" which experience LOS F are delineated in these Figures by a red line; all others are lightly indicated. Congestion develops rapidly around concentrations of population and traffic bottlenecks.

Figure 7-3 presents the congestion pattern 45 minutes after the Advisory to Evacuate (ATE). Congestion exists northbound on State Highway 60, primarily the result of those evacuating Matagorda Beach.

Figure 7-4 indicates that at 1 hour and 15 minutes after the ATE, congestion persists northbound on State Highway 60, especially through Wadsworth near the intersection with FM 521. Congestion persists outside of the EPZ, notably at the intersection of State Highway 60 and FM 2668, and to a lesser extent within Bay City. Traffic guides are recommended at the intersection of State Highway 60 and FM 2668 to facilitate the flow of evacuating traffic. All congestion in the shadow area is clear by 1 hour and 45 minutes after the ATE.

### 7.3 Evacuation Rates

While all routes remain available for evacuees, only a few of these routes will be needed towards the end of the evacuation. Figure 7-5 indicates that evacuation is a continuous, dynamic process. This plot indicates the rate at which traffic flows out of the indicated areas for the case of an evacuation of the entire EPZ (Region R03) under the indicated conditions. Appendix J presents these plots for all Evacuation Scenarios for Region R03.

As indicated in Figure 7-5, there is typically a long "tail" to these distributions. Vehicles evacuate an area slowly at the beginning, as people respond to the Advisory to Evacuate at different rates. Then traffic demand builds rapidly (slopes of curves increase). When the system becomes congested, traffic exits the EPZ at rates somewhat below capacity until some evacuation routes have cleared. As more routes clear, the aggregate rate of egress slows since many vehicles have already left the EPZ. Towards the end of the process, relatively few evacuation routes service the remaining demand. It is reasonable to expect that some evacuees may delay or lengthen their mobilization activities and evacuate at a later time as a result; these ETE estimates do not (and should not) be distorted to account for these few laggards.

This decline in aggregate flow rate, towards the end of the process, is characterized by these curves flattening and gradually becoming horizontal. Ideally, it would be desirable to fully saturate all evacuation routes equally so that all will service traffic near capacity levels and all will clear at the same time. For this ideal situation, all curves would retain the same slope until the end -- thus minimizing evacuation time. In the real world, this ideal is generally unattainable reflecting the variation in population density and in highway capacity over the EPZ.

#### 7.4 Guidance on Using ETE Tables

Tables 7-1A through 7-1D present the ETE values for all 22 Evacuation Regions and all 12 Evacuation Scenarios. They are organized as follows:

Table	Contents
7-1A	ETE represents the elapsed time required for 50 percent of the population within a Region, to evacuate from that Region.
7-1B	ETE represents the elapsed time required for 90 percent of the population within a Region, to evacuate from that Region.
7-1C	ETE represents the elapsed time required for 95 percent of the population within a Region, to evacuate from that Region.
7-1D	ETE represents the elapsed time required for 100 percent of the population within a Region, to evacuate from that Region.

The user first determines the percentile of population for which the ETE is sought. The applicable value of ETE within the chosen Table may then be identified using the following procedure:

1. Identify the applicable **Scenario**:
  - The Season
    - Summer
    - Winter (also Autumn and Spring)
  - The Day of Week
    - Midweek
    - Weekend
  - The Time of Day
    - Midday
    - Evening
  - Weather Condition
    - Good Weather
    - Rain
  - Special Event (if any)
    - Holiday Beach Weekend
    - New Plant Construction

While these Scenarios are designed, in aggregate, to represent conditions throughout the year, some further clarification is warranted:

- The conditions of a summer evening (either midweek or weekend) and rain are not explicitly identified in Tables 7-1A through 7-1D. For these

- conditions, Scenario (4) applies.
  - The conditions of a winter evening (either midweek or weekend) and rain are not explicitly identified in Tables 7-1A through 7-1D. For these conditions, Scenario (9) applies.
  - The seasons are defined as follows:
    - Summer implies that public schools are *not* in session.
    - Winter, Spring and Autumn imply that public schools *are* in session.
  - Time of Day: Midday implies the time over which most commuters are at work.
2. With the Scenario identified, now identify the **Evacuation Region**:
- Determine the projected azimuth direction of the plume, as dictated by the wind direction. The wind direction is expressed in degrees, clockwise from North and represents the direction *from which* the wind originates.
  - Determine the distance that the Evacuation Region will extend from the South Texas Project. The applicable distances and their associated candidate Regions are given below:
    - 2 Miles (Region R01)
    - 5 Miles (Regions R02 and R04 through R10)
    - To EPZ Boundary (Regions R03 and R11 through R22)
  - Enter Table 7-2 and identify the applicable group of candidate Regions based on the distance that the selected Region extends from STP. Select the Evacuation Region identifier in that row from the first column of the Table.
3. Determine the **ETE for the Scenario** identified in Step 1 and the Region identified in Step 2, as follows:
- The columns of Table 7-1 are labeled with the Scenario numbers. Identify the proper column in the selected Table using the Scenario number determined in Step 1.
  - Identify the row in this table that provides ETE values for the Region identified in Step 2.
  - The unique data cell defined by the column and row so determined contains the desired value of ETE expressed in Hours:Minutes.

### Example

It is desired to identify the ETE for the following conditions:

- Sunday, August 10<sup>th</sup> at 4:00 AM.
- The weather is good.
- Wind direction is from 300°.
- Wind speed is such that the distance to be evacuated is judged to be 10 miles (to EPZ boundary).
- The desired ETE is that value needed to evacuate 95 percent of the population from within the impacted Region.



Table 7-1C is applicable because the 95<sup>th</sup>-percentile population is desired. Proceed as follows:

1. Identify the Scenario as summer, weekend, evening and good weather. Entering Table 7-1C these descriptors identify this combination of circumstances as being Scenario 5.
2. Enter Table 7-1C and locate the group entitled “Evacuate 5-Mile Ring and Downwind to EPZ Boundary”. Under “Wind Direction”, identify the 299° to 343° azimuth and read REGION R21 in the first column of that row.
3. Enter Table 7-1C to locate the data cell containing the value of ETE for Scenario 5 and Region R21. This data cell is in column (5) and in the row for Region R21; it contains the ETE value of **3:30**.

Table 7-1A. Time To Clear The Indicated Area of 50 Percent of the Affected Population

Scenario: Region Wind From:	Summer			Winter			Summer			Winter			
	Midweek		Midday	Midweek		Midday	Midweek		Holiday	Midweek		Midday	
	(1)	(2)	(3)	(4)	(5)	(6)	(7)	(8)	(9)	(10)	Scenario:	Region Wind From:	
R01 2-mile ring	0:40	0:40	0:40	0:40	0:40	0:40	0:40	0:40	0:40	0:40	R01 2-mile ring	0:40	0:50
R02 5-mile ring	0:55	1:05	1:05	1:05	1:05	0:55	0:55	1:05	1:05	1:10	R02 5-mile ring	1:45	1:00
R03 Entire EPZ	1:10	1:10	1:15	1:20	1:10	1:10	1:10	1:15	1:20	1:25	R03 Entire EPZ	1:35	1:15
Entire 2-Mile Region, 5-Mile Region, and EPZ													
2-Mile Ring and Downwind to 5 Miles													
R04 29° to 50°	0:40	0:45	0:45	0:45	0:45	0:40	0:45	0:45	0:45	0:45	R04 29° to 50°	0:45	0:50
R05 51° to 106°	0:45	0:45	0:50	0:50	0:50	0:45	0:45	0:50	0:50	0:50	R05 51° to 106°	0:50	0:55
R06 107° to 140°	0:45	0:45	0:45	0:50	0:45	0:45	0:45	0:45	0:50	0:45	R06 107° to 140°	0:45	0:55
R07 141° to 174°	0:50	0:50	0:50	0:50	0:50	0:50	0:50	0:50	0:50	0:50	R07 141° to 174°	0:50	0:55
R08 175° to 230°	0:45	0:45	0:45	0:45	0:45	0:45	0:45	0:45	0:45	0:45	R08 175° to 230°	0:45	0:55
R09 231° to 286°	0:50	0:55	1:00	1:05	1:00	0:50	0:50	1:00	1:05	1:05	R09 231° to 286°	1:45	1:00
R10 287° to 331°	0:50	0:50	1:00	1:05	1:00	0:50	0:50	1:00	1:05	1:05	R10 287° to 331°	1:45	0:55
R01 332° to 28°	0:40	0:40	0:40	0:40	0:40	0:40	0:40	0:40	0:40	0:40	R01 332° to 28°	0:40	0:50
5-Mile Ring and Downwind to EPZ Boundary													
R11 355° to 50°	1:00	1:00	1:05	1:05	1:05	1:00	1:00	1:10	1:10	1:15	R11 355° to 50°	1:25	1:05
R12 51° to 61°	1:00	1:00	1:05	1:05	1:05	1:00	1:00	1:10	1:10	1:15	R12 51° to 61°	1:25	1:05
R13 62° to 95°	1:00	1:00	1:05	1:05	1:05	1:00	1:00	1:10	1:10	1:15	R13 62° to 95°	1:25	1:05
R14 96° to 129°	1:00	1:00	1:05	1:05	1:05	1:00	1:00	1:10	1:10	1:20	R14 96° to 129°	1:25	1:05
R15 130° to 163°	1:00	1:00	1:05	1:05	1:05	1:00	1:00	1:05	1:05	1:15	R15 130° to 163°	1:25	1:05
R16 164° to 174°	1:05	1:10	1:10	1:15	1:10	1:05	1:05	1:15	1:20	1:20	R16 164° to 174°	1:30	1:15
R17 175° to 219°	1:05	1:10	1:10	1:15	1:10	1:05	1:05	1:15	1:20	1:20	R17 175° to 219°	1:50	1:15
R18 220° to 230°	1:05	1:05	1:10	1:15	1:10	1:05	1:05	1:15	1:15	1:20	R18 220° to 230°	1:50	1:10
R19 231° to 286°	1:05	1:10	1:15	1:20	1:10	1:05	1:05	1:15	1:15	1:20	R19 231° to 286°	2:00	1:15
R20 287° to 298°	0:55	0:55	1:05	1:10	1:05	0:55	0:55	1:05	1:10	1:10	R20 287° to 298°	1:50	1:00
R21 299° to 343°	0:55	0:55	1:05	1:10	1:05	0:55	0:55	1:05	1:10	1:10	R21 299° to 343°	1:50	1:00
R22 344° to 354°	1:00	1:05	1:10	1:15	1:05	1:00	1:00	1:15	1:15	1:20	R22 344° to 354°	1:50	1:05

Table 7-1B. Time To Clear The Indicated Area of 90 Percent of the Affected Population

Scenario: Region Wind From:	Summer			Winter			Winter			Summer			
	Midweek		Midday	Midweek		Midday	Weekend		Midday	Holiday		Midweek	
	(1)	(2)	(3)	(4)	(5)	(6)	(7)	(8)	(9)	(10)	(11)	(12)	
Good Weather	Rain	Good Weather	Rain	Evening	Good Weather	Rain	Good Weather	Rain	Good Weather	Rain	Good Weather	Midday	
Region Wind From:	Scenario:			Scenario:			Scenario:			Scenario:			
Entire 2-Mile Region, 5-Mile Region, and EPZ													
R01 2-mile ring	0:55	0:55	0:50	0:50	0:50	0:55	0:55	0:50	0:50	0:50	0:50	R01 2-mile ring	0:50
R02 5-mile ring	2:10	2:20	2:10	2:10	2:30	2:30	2:40	2:50	2:50	3:00	3:00	R02 5-mile ring	3:10
R03 Entire EPZ	3:00	3:00	2:40	2:40	2:50	3:30	3:30	3:20	3:20	3:40	3:40	R03 Entire EPZ	3:30
2-Mile Ring and Downwind to 5 Miles													
R04 29° to 50°	0:55	1:00	1:40	1:40	1:40	1:00	1:00	1:50	1:50	1:50	1:50	R04 29° to 50°	1:40
R05 51° to 106°	1:00	1:00	2:30	2:30	2:30	1:05	1:05	2:30	2:30	2:30	2:30	R05 51° to 106°	2:30
R06 107° to 140°	1:00	1:00	2:00	2:00	2:00	1:00	1:00	2:00	2:00	2:00	2:00	R06 107° to 140°	2:00
R07 141° to 174°	1:05	1:05	2:10	2:10	2:10	1:05	1:05	2:10	2:10	2:10	2:10	R07 141° to 174°	2:10
R08 175° to 230°	0:55	1:00	1:00	1:00	1:00	1:00	1:00	1:00	1:00	1:00	1:00	R08 175° to 230°	1:00
R09 231° to 286°	2:10	2:10	2:00	2:00	2:10	2:20	2:20	2:40	2:40	2:50	2:50	R09 231° to 286°	3:10
R10 287° to 331°	2:00	2:10	2:00	2:00	2:10	2:20	2:20	2:40	2:40	2:50	2:50	R10 287° to 331°	3:10
R01 332° to 28°	0:55	0:55	0:50	0:50	0:50	0:55	0:55	0:50	0:50	0:50	0:50	R01 332° to 28°	0:50
5-Mile Ring and Downwind to EPZ Boundary													
R11 355° to 50°	2:50	2:50	2:40	2:40	2:50	3:10	3:10	3:30	3:30	3:40	3:40	R11 355° to 50°	3:15
R12 51° to 61°	2:40	2:40	2:20	2:20	2:40	3:10	3:10	3:10	3:10	3:30	3:30	R12 51° to 61°	3:10
R13 62° to 95°	2:40	2:40	2:20	2:20	2:40	3:10	3:10	3:10	3:10	3:30	3:30	R13 62° to 95°	3:10
R14 96° to 129°	2:50	2:50	2:20	2:20	2:40	3:20	3:20	3:10	3:10	3:30	3:30	R14 96° to 129°	3:10
R15 130° to 163°	2:30	2:30	2:10	2:10	2:30	3:00	3:00	2:50	2:50	3:10	3:10	R15 130° to 163°	3:10
R16 164° to 174°	2:50	2:50	2:20	2:20	2:40	3:20	3:20	3:10	3:10	3:20	3:20	R16 164° to 174°	3:10
R17 175° to 219°	3:00	3:00	2:40	2:40	2:50	3:20	3:20	3:20	3:20	3:30	3:30	R17 175° to 219°	3:20
R18 220° to 230°	2:50	2:50	2:40	2:40	2:50	3:10	3:10	3:20	3:20	3:30	3:30	R18 220° to 230°	3:20
R19 231° to 286°	2:50	2:50	2:40	2:40	2:50	3:10	3:10	3:20	3:20	3:30	3:30	R19 231° to 286°	3:30
R20 287° to 298°	2:20	2:20	2:10	2:10	2:30	2:50	2:50	2:50	2:50	3:10	3:10	R20 287° to 298°	3:25
R21 299° to 343°	2:20	2:20	2:10	2:10	2:30	2:50	2:50	2:50	2:50	3:10	3:10	R21 299° to 343°	3:25
R22 344° to 354°	2:40	2:40	2:30	2:30	2:50	3:10	3:10	3:20	3:20	3:40	3:40	R22 344° to 354°	3:25

Table 7-1C. Time To Clear The Indicated Area of 95 Percent of the Affected Population

Scenario:	Summer		Summer		Summer		Winter		Winter		Winter		Summer						
	Midweek	Midweek	Midweek	Midweek	Midweek	Midweek	Midweek	Midweek	Midweek	Midweek	Midweek	Midweek	Midweek	Midweek					
															(1)	(2)	(3)	(4)	(5)
Region Wind From:	Good Weather	Rain	Good Weather	Rain	Good Weather	Rain	Good Weather	Rain	Good Weather	Rain	Good Weather	Rain	Good Weather	Beach Holiday	Midday	Region Wind From:	Midweek	Summer	Summer
	0:55	0:55	0:50	0:50	0:50	0:50	0:55	0:55	0:50	0:50	0:50	0:50	0:50	0:50	0:50	R01	2-mile ring	0:50	1:40
R01	3:10	3:20	3:00	3:00	3:20	3:20	3:40	3:40	3:40	3:50	3:50	4:10	4:10	4:10	4:10	R02	5-mile ring	3:25	2:10
R02	4:00	4:00	3:40	3:40	4:00	4:00	4:20	4:20	4:20	4:10	4:20	4:20	4:20	4:20	4:20	R03	Entire EPZ	3:50	3:40
R03	Entire 2-Mile Region, 5-Mile Region, and EPZ																		
2-Mile Ring and Downwind to 5 Miles																			
R04	1:00	1:00	2:30	2:30	2:50	2:50	1:00	1:00	2:50	2:50	2:50	2:50	2:50	2:50	2:50	R04	29° to 50°	2:30	1:40
R05	1:50	1:50	3:25	3:25	3:30	3:30	1:50	1:50	3:40	3:40	3:40	3:40	3:40	3:40	3:40	R05	51° to 106°	3:25	1:40
R06	1:30	1:30	2:50	2:50	2:40	2:40	1:30	1:30	2:50	2:50	2:50	2:50	2:50	2:50	2:50	R06	107° to 140°	2:50	1:40
R07	1:50	1:50	2:50	2:50	2:40	2:40	1:50	1:50	2:50	2:50	2:50	2:50	2:50	2:50	2:50	R07	141° to 174°	2:50	1:50
R08	1:00	1:00	1:30	1:30	1:30	1:30	1:00	1:00	1:30	1:30	1:30	1:30	1:30	1:30	1:30	R08	175° to 230°	1:30	1:40
R09	3:00	3:00	2:50	2:50	3:00	3:00	3:30	3:30	3:40	3:40	3:40	3:40	3:40	3:40	3:40	R09	231° to 286°	3:25	2:00
R10	3:00	3:00	2:50	2:50	3:00	3:00	3:30	3:30	3:40	3:40	3:40	3:40	3:40	3:40	3:40	R10	287° to 331°	3:25	2:00
R11	0:55	0:55	0:50	0:50	0:50	0:50	0:55	0:55	0:50	0:50	0:50	0:50	0:50	0:50	0:50	R11	332° to 28°	0:50	1:40
5-Mile Ring and Downwind to EPZ Boundary																			
R11	3:50	3:50	3:40	3:40	3:50	3:50	4:10	4:10	4:10	4:10	4:10	4:10	4:10	4:10	4:10	R11	355° to 50°	3:25	2:50
R12	3:40	3:40	3:20	3:30	3:50	3:50	4:10	4:10	4:10	4:10	4:10	4:10	4:10	4:10	4:10	R12	51° to 61°	3:25	3:00
R13	3:40	3:40	3:20	3:30	3:50	3:50	4:10	4:10	4:10	4:10	4:10	4:10	4:10	4:10	4:10	R13	62° to 95°	3:25	3:00
R14	3:50	3:50	3:30	3:30	3:50	3:50	4:10	4:10	4:10	4:10	4:10	4:10	4:10	4:10	4:10	R14	96° to 129°	3:25	3:10
R15	3:30	3:30	3:00	3:00	3:30	3:30	4:00	4:00	4:00	4:00	4:00	4:00	4:00	4:00	4:00	R15	130° to 163°	3:25	2:50
R16	3:50	3:50	3:20	3:30	3:50	3:50	4:10	4:10	4:10	4:10	4:10	4:10	4:10	4:10	4:10	R16	164° to 174°	3:30	3:40
R17	4:00	4:00	3:40	3:40	4:00	4:00	4:10	4:10	4:10	4:10	4:10	4:10	4:10	4:10	4:10	R17	175° to 219°	3:35	3:40
R18	3:50	3:50	3:40	3:40	4:00	4:00	4:10	4:10	4:10	4:10	4:10	4:10	4:10	4:10	4:10	R18	220° to 230°	3:35	3:30
R19	3:50	3:50	3:40	3:40	3:50	3:50	4:10	4:10	4:10	4:10	4:10	4:10	4:10	4:10	4:10	R19	231° to 286°	3:50	3:30
R20	3:20	3:20	3:00	3:00	3:30	3:30	3:50	3:50	4:00	4:00	4:00	4:00	4:00	4:00	4:00	R20	287° to 298°	3:40	2:30
R21	3:20	3:20	3:00	3:00	3:30	3:30	3:50	3:50	4:00	4:00	4:00	4:00	4:00	4:00	4:00	R21	299° to 343°	3:40	2:30
R22	3:50	3:50	3:40	3:40	3:50	3:50	4:10	4:10	4:10	4:10	4:10	4:10	4:10	4:10	4:10	R22	344° to 354°	3:40	3:00

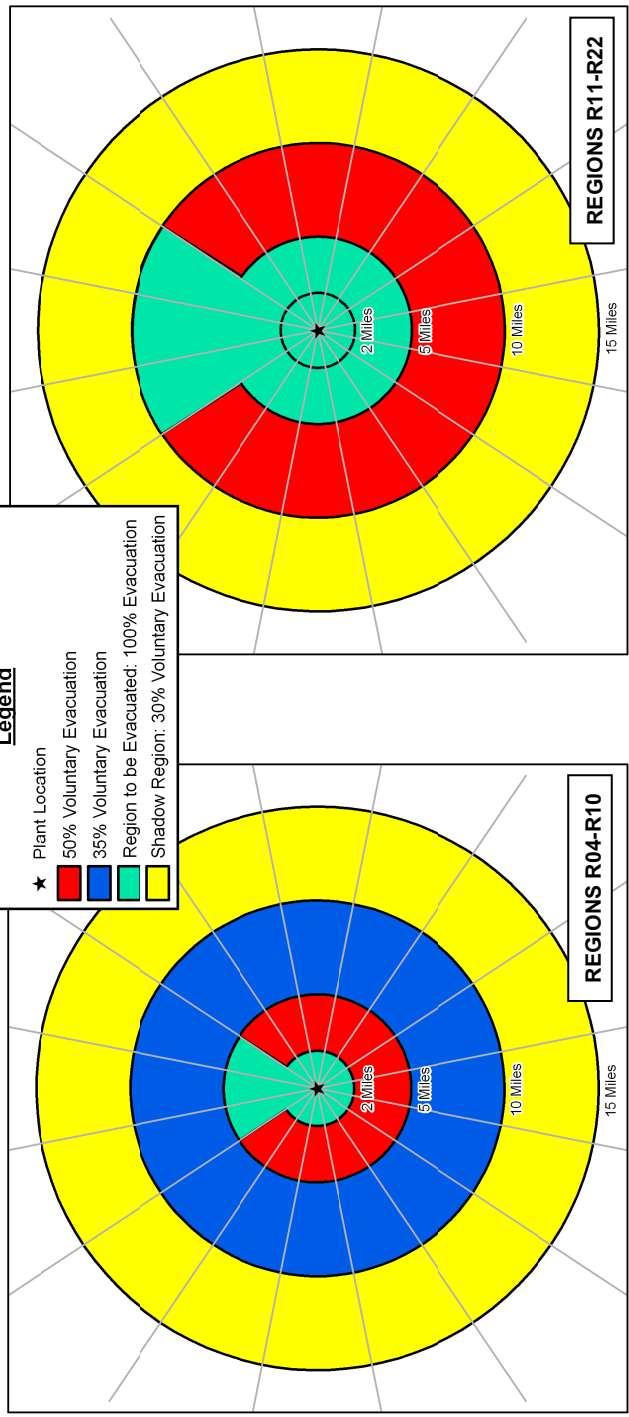
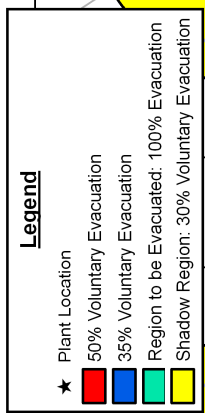
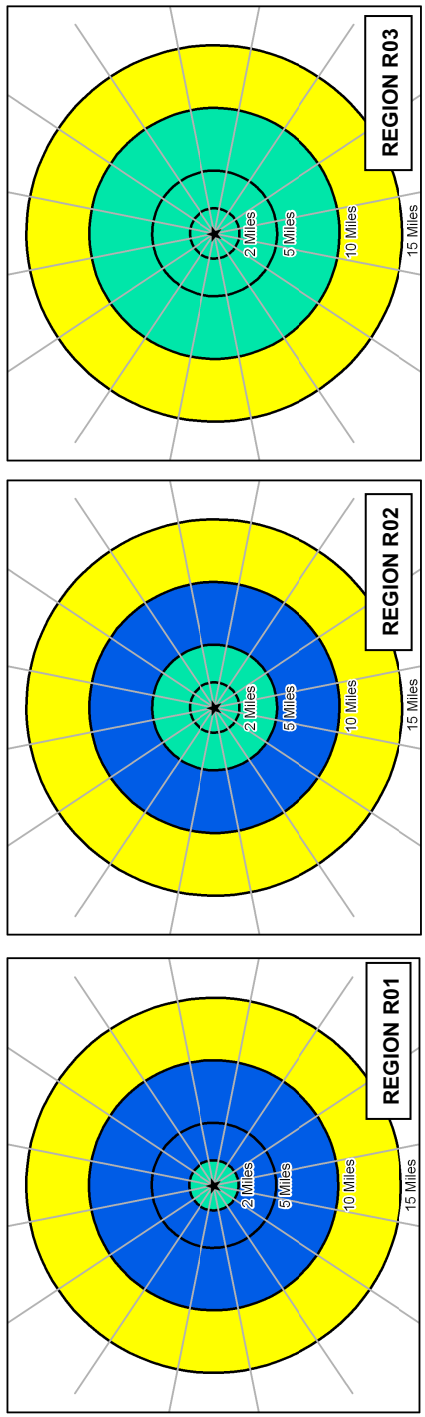
Table 7-1D. Time To Clear The Indicated Area of 100 Percent of the Affected Population

Scenario: Region Wind From:	Summer		Summer		Summer		Winter		Winter		Winter		Summer	
	Midweek (1)	Midday (2)	Weekend (3)	Midweek (4)	Evening (5)	Scenario: Region Wind From:	Midweek (6)	Midday (7)	Weekend (8)	Midweek (9)	Evening (10)	Scenario: Region Wind From:	Midweek (11)	Midday (12)
R01 2-mile ring	1:00	1:00	1:00	1:00	1:00	R01 2-mile ring	1:00	1:00	1:00	1:00	1:00	R01 2-mile ring	1:00	2:00
R02 5-mile ring	6:00	6:10	5:10	5:10	5:10	R02 5-mile ring	6:00	6:00	5:10	5:10	5:10	R02 5-mile ring	5:10	6:00
R03 Entire EPZ	6:10	6:10	5:50	5:50	5:50	R03 Entire EPZ	6:10	6:10	5:50	5:50	5:50	R03 Entire EPZ	5:50	6:10
Entire 2-Mile Region, 5-Mile Region, and EPZ														
2-Mile Ring and Downwind to 5 Miles														
R04 29° to 50°	4:50	5:00	4:50	4:50	4:50	R04 29° to 50°	4:50	5:00	4:50	4:50	4:50	R04 29° to 50°	4:50	5:00
R05 51° to 106°	4:50	5:00	5:00	5:00	5:00	R05 51° to 106°	4:50	5:00	5:00	5:00	5:00	R05 51° to 106°	5:00	5:00
R06 107° to 140°	4:50	4:50	5:00	5:00	5:00	R06 107° to 140°	4:50	4:50	5:00	5:00	5:00	R06 107° to 140°	5:00	5:00
R07 141° to 174°	4:50	4:50	5:00	5:00	5:00	R07 141° to 174°	4:50	4:50	5:00	5:00	5:00	R07 141° to 174°	5:00	5:00
R08 175° to 230°	3:50	3:50	2:50	2:50	2:50	R08 175° to 230°	3:50	3:50	2:50	2:50	2:50	R08 175° to 230°	2:50	3:50
R09 231° to 286°	6:00	6:10	5:10	5:10	5:10	R09 231° to 286°	6:00	6:00	5:10	5:10	5:10	R09 231° to 286°	5:10	6:00
R10 287° to 331°	6:00	6:10	5:10	5:10	5:10	R10 287° to 331°	6:00	6:00	5:10	5:10	5:10	R10 287° to 331°	5:10	6:00
R01 332° to 28°	1:00	1:00	1:00	1:00	1:00	R01 332° to 28°	1:00	1:00	1:00	1:00	1:00	R01 332° to 28°	1:00	2:00
5-Mile Ring and Downwind to EPZ Boundary														
R11 355° to 50°	6:00	6:10	5:50	5:50	5:50	R11 355° to 50°	6:00	6:00	5:50	5:50	5:50	R11 355° to 50°	5:50	6:00
R12 51° to 61°	6:00	6:10	5:50	5:50	5:50	R12 51° to 61°	6:00	6:10	5:50	5:50	5:50	R12 51° to 61°	5:50	6:00
R13 62° to 95°	6:00	6:10	5:50	5:50	5:50	R13 62° to 95°	6:00	6:10	5:50	5:50	5:50	R13 62° to 95°	5:50	6:00
R14 96° to 129°	6:00	6:10	5:50	5:50	5:50	R14 96° to 129°	6:00	6:10	5:50	5:50	5:50	R14 96° to 129°	5:50	6:00
R15 130° to 163°	6:00	6:10	5:10	5:10	5:10	R15 130° to 163°	6:00	6:00	5:10	5:10	5:10	R15 130° to 163°	5:10	6:00
R16 164° to 174°	6:10	6:10	5:20	5:20	5:20	R16 164° to 174°	6:10	6:10	5:20	5:20	5:10	R16 164° to 174°	5:10	6:00
R17 175° to 219°	6:10	6:10	5:20	5:20	5:20	R17 175° to 219°	6:10	6:10	5:20	5:20	5:10	R17 175° to 219°	5:10	6:10
R18 220° to 230°	6:10	6:10	5:20	5:20	5:20	R18 220° to 230°	6:10	6:10	5:20	5:20	5:10	R18 220° to 230°	5:10	6:10
R19 231° to 286°	6:10	6:10	5:20	5:20	5:20	R19 231° to 286°	6:10	6:10	5:20	5:20	5:20	R19 231° to 286°	5:10	6:10
R20 287° to 298°	6:10	6:10	5:10	5:10	5:10	R20 287° to 298°	6:10	6:10	5:10	5:10	5:10	R20 287° to 298°	5:10	6:00
R21 299° to 343°	6:10	6:10	5:10	5:10	5:10	R21 299° to 343°	6:10	6:10	5:10	5:10	5:10	R21 299° to 343°	5:10	6:00
R22 344° to 354°	6:10	6:10	5:50	5:50	5:50	R22 344° to 354°	6:10	6:10	5:50	5:50	5:50	R22 344° to 354°	5:50	6:00

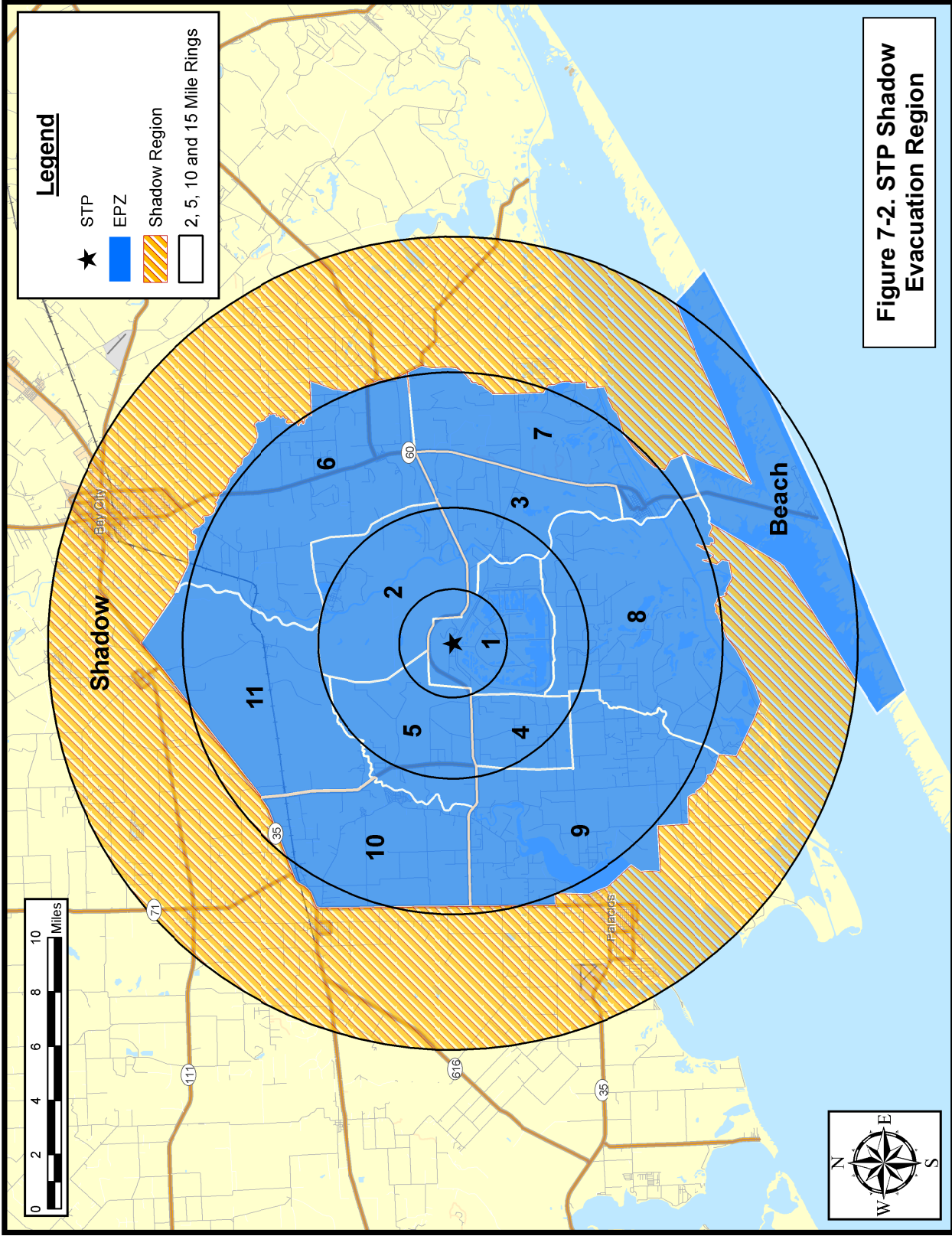
Table 7-2. Description of Evacuation Regions												
Region	Description	ZONE										
		1	2	3	4	5	6	7	8	9	10	11
R01	2 mile ring											
R02	5-mile ring											
R03	Full EPZ											
Evacuate 2 mile ring and 5 miles downwind												
Region	Wind Direction (From) in Degrees	ZONE										
		1	2	3	4	5	6	7	8	9	10	11
R04	29 - 50											
R05	51 - 106											
R06	107 - 140											
R07	141 - 174											
R08	175 - 230											
R09	231 - 286											
R10	287 - 331											
R01*	332 - 28											
Evacuate 5 mile ring and downwind to EPZ boundary												
Region	Wind Direction (From) in Degrees	ZONE										
		1	2	3	4	5	6	7	8	9	10	11
R11	355 - 50											
R12	51 - 61											
R13	62 - 95											
R14	96 - 129											
R15	130 - 163											
R16	164 - 174											
R17	175 - 219											
R18	220 - 230											
R19	231 - 286											
R20	287 - 298											
R21	299 - 343											
R22	344 - 354											

**Residents and Transients in the Matagorda Beach area are always evacuated.**

\* Note that evacuating the 2-mile ring and evacuating the 5-mile ring with wind from 332° to 28° both result in the evacuation of Region 1. Thus, R01 is shown twice in the table above.

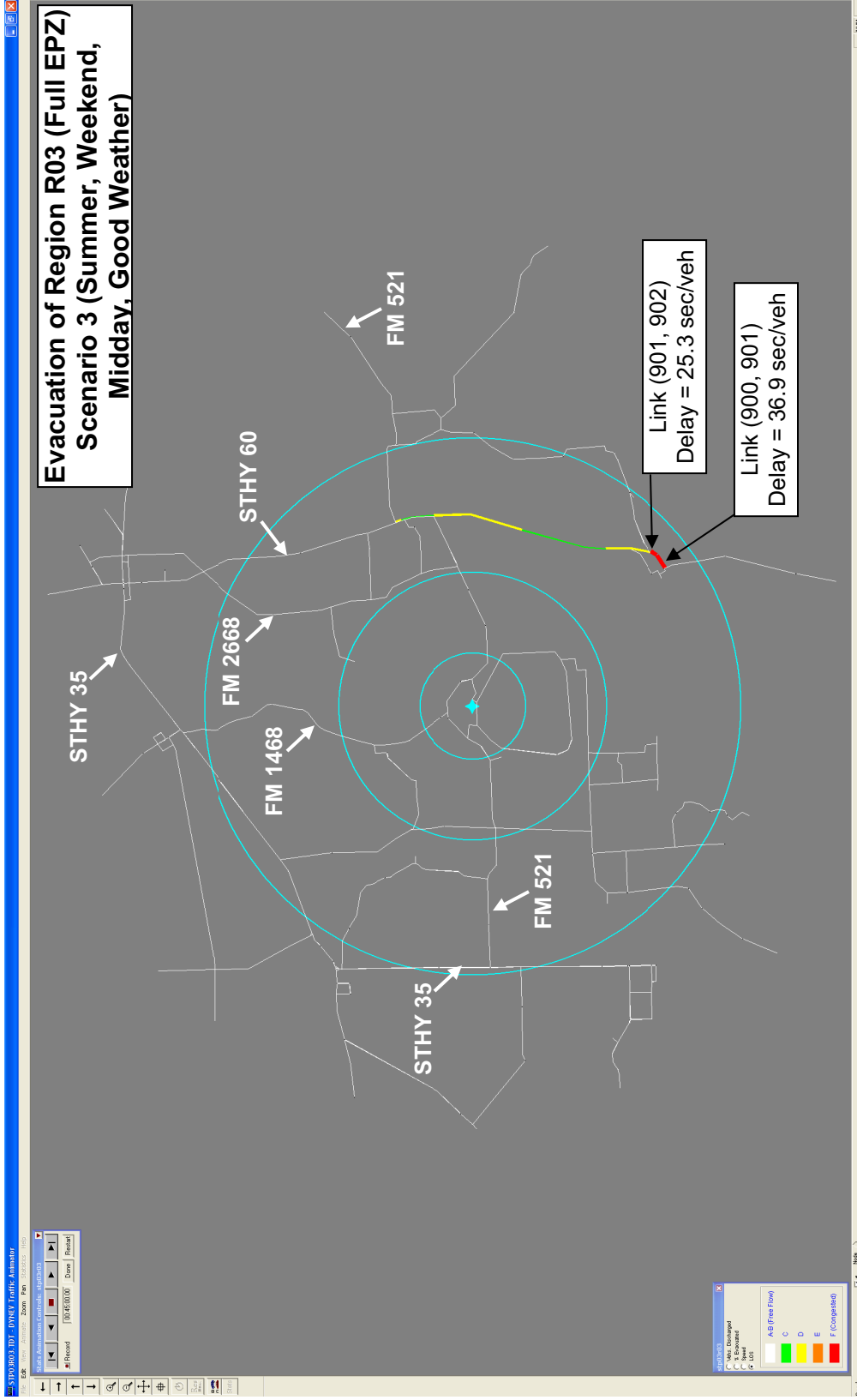


**Figure 7-1. Voluntary Evacuation Methodology**

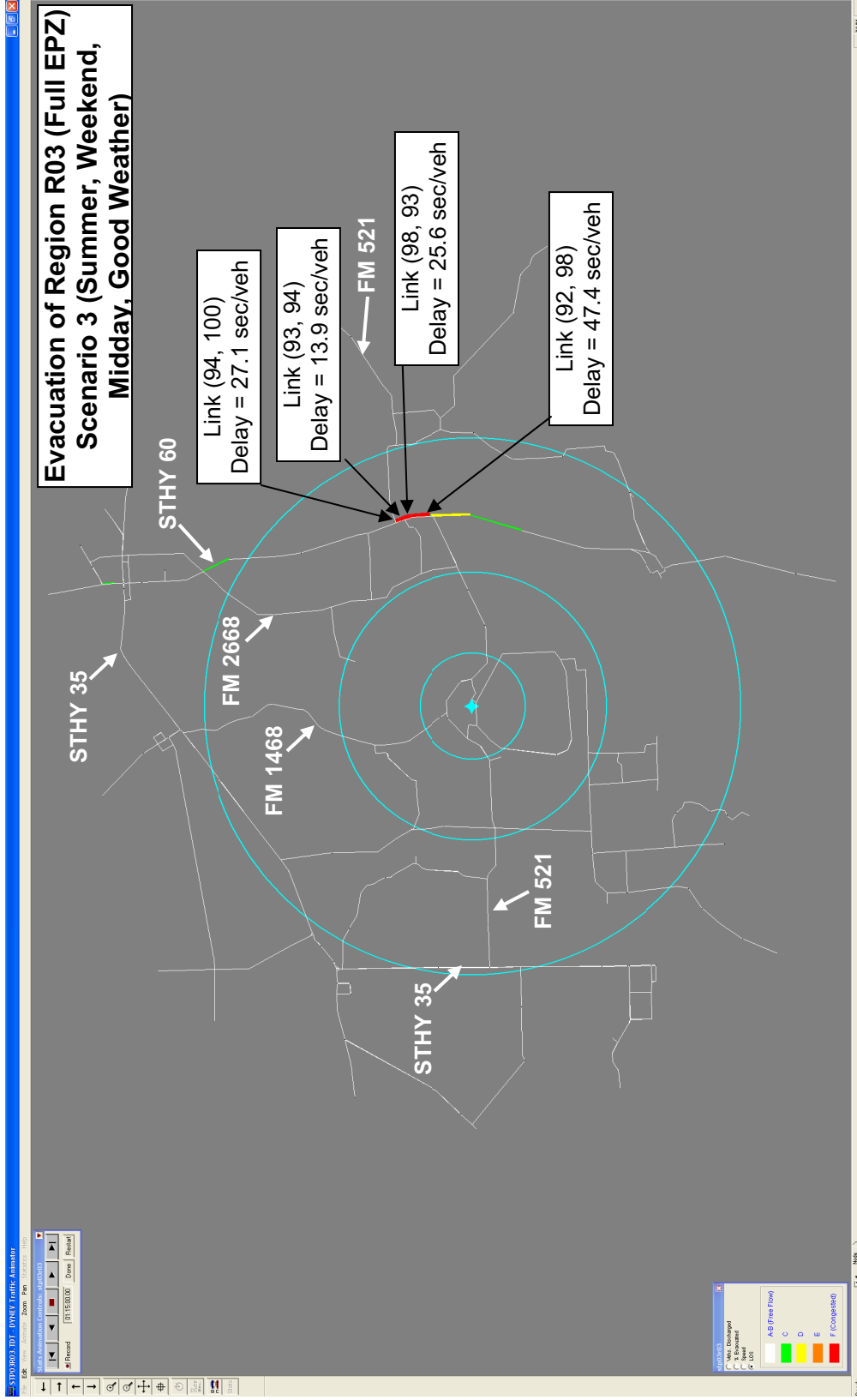


**Figure 7-2. STP Shadow Evacuation Region**



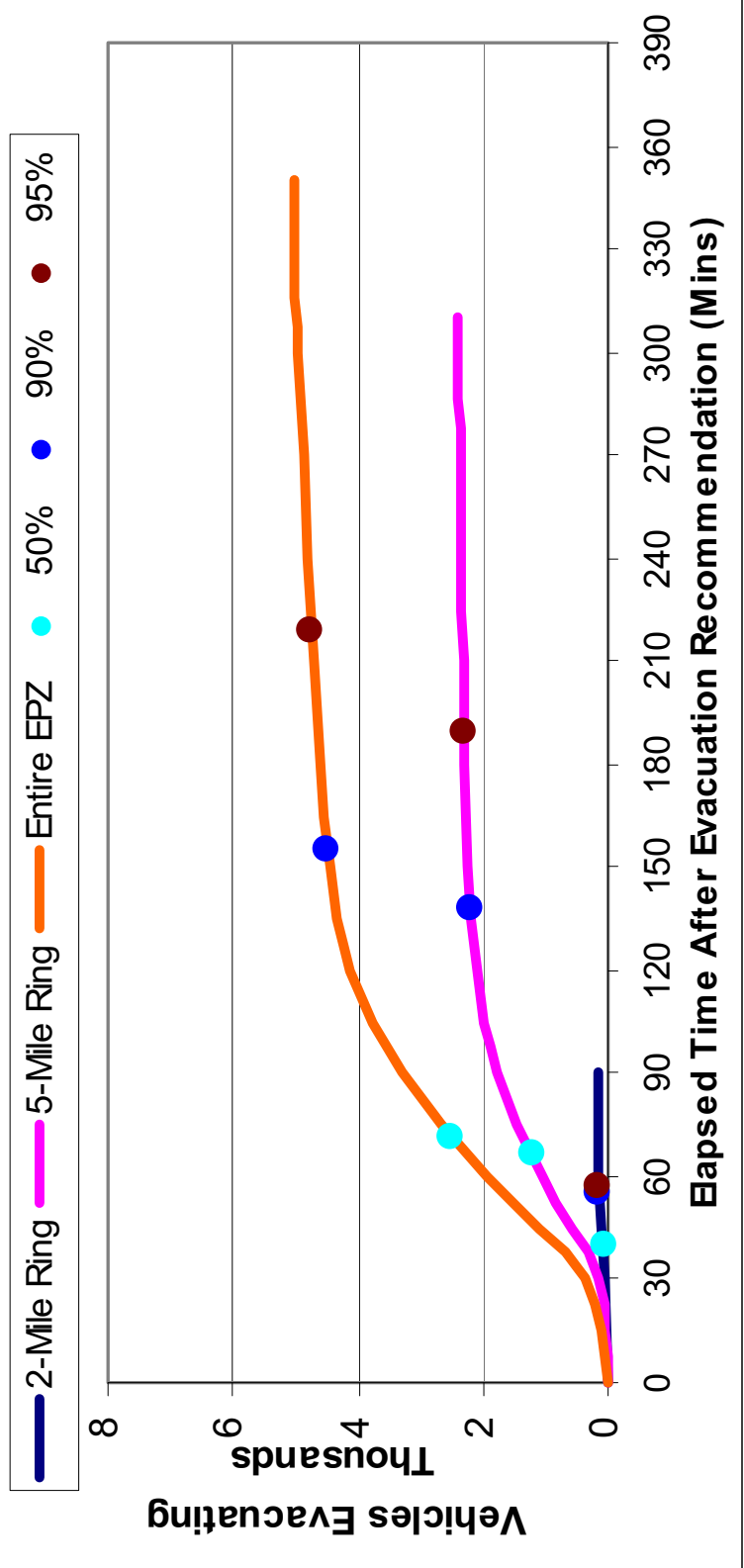


**Figure 7-3. Traffic Congestion at 45 Minutes after the Advisory to Evacuate**



**Figure 7-4 Traffic Congestion at 1 Hour and 15 Minutes after the Advisory to Evacuate**

### Evacuation Time Estimates Summer, Weekend, Midday, Good Weather (Scenario 3)



**Figure 7-5. Evacuation Time Estimates for STP  
Summer, Weekend, Midday, Good Weather  
Evacuation of Region R03 (Entire EPZ)**

## 8. TRANSIT-DEPENDENT AND SPECIAL FACILITY EVACUATION TIME ESTIMATES

This section details the analyses applied and the results obtained in the form of evacuation time estimates for transit vehicles (buses). The demand for transit service reflects the needs of two population groups: (1) residents, employees and transients with no vehicles available; and (2) residents of special facilities such as schools.

These transit vehicles merge into and become a part of the general evacuation traffic environment that is comprised mostly of “passenger cars” (pc’s). The presence of each transit vehicle in the evacuating traffic stream is represented within the modeling paradigm described in Appendix D as equivalent to two pc’s. This equivalence factor represents the larger size and more sluggish operating characteristics of a transit vehicle relative to those of a pc.

Transit vehicles must be mobilized in preparation for their respective evacuation missions. Specifically:

- Bus drivers must be alerted
- They must travel to the bus depot
- They must be briefed there and assigned to a route or facility

These activities consume time. The schools in Matagorda and Tidehaven have designated drivers and buses available on site (or within 1.5 miles) at each school. As a result, the transit mobilization time for schools is estimated as 30 minutes. The mobilization time for buses transporting the transit dependent population is responsive to the mobilization time of that population.

During this transit mobilization period, other mobilization activities are taking place. One of these is the action taken by parents, neighbors, relatives and friends to pick up children from school prior to the arrival of buses, so that they may join their families. Virtually all studies of evacuations have concluded that this “bonding” process of uniting family units is universally prevalent during emergencies and should be anticipated in the planning process. Many emergency plans, however, call for parents to pick up children at host schools or reception centers to speed the evacuation of the school children in the event that buses need to return to the EPZ to evacuate transit dependents. We provide estimates of buses under the assumption that all children will be evacuated by bus, to present an upper bound estimate of the transit vehicles needed.

The procedure is:

- Estimate demand for transit service
- Estimate time to perform all transit functions
- Estimate route travel times to the EPZ boundary and to the school reception centers

## 8.1 Transit-Dependent People - Demand Estimate

The telephone survey (see Appendix F) results were used to estimate the portion of the population requiring transit service:

- Those persons in households that do not have a vehicle available.
- Those persons in households that do have vehicle(s) that would not be available at the time the evacuation is ordered.

In the latter group, the vehicle(s) may be inoperable or used by a commuter(s) who does not return (or is not expected to return) home to evacuate the household.

Table 8-1 presents estimates of transit-dependent people. Note:

- Estimates of persons requiring transit vehicles include school children. For those evacuation scenarios where children are at school when an evacuation is ordered, separate transportation is provided for the school children. The actual need for transit vehicles by residents is thereby less than the given estimates. However, we will not reduce our estimates of transit vehicles since it would add to the complexity of the implementation procedures.
- It is reasonable and appropriate to consider that many transit-dependent persons will evacuate by ride-sharing with neighbors, friends or family. For example, nearly 80 percent of those who evacuated from Mississauga, Ontario who did not use their own cars, shared a ride with neighbors or friends. Other documents report that approximately 70 percent of transit-dependent persons were evacuated via ride-sharing. **We will adopt a conservative estimate that 50 percent of transit-dependent persons will ride-share.**

The estimated number of bus trips needed to service transit-dependent persons is based on an estimate of average bus occupancy of 30 persons at the conclusion of the bus run. Transit vehicle seating capacities typically equal or exceed 60 children (equivalent to 40 adults). If transit vehicle evacuees are two-thirds adults and one-third children, then the number of "adult seats" taken by 30 persons is  $20 + (2/3 \times 10) = 27$ . On this basis, the average load factor anticipated is  $(27/40) \times 100 = 68$  percent. Thus, if the actual demand for service exceeds the estimates of Table 8-1 by 50 percent, the demand for service can still be accommodated by the available bus seating capacity.

$$\left( 20 + \left( \frac{2}{3} \times 10 \right) \right) \div 40 \times 1.5 = 1.00$$

Table 8-1 indicates that transportation must be provided for 88 people. Therefore, a total of 3 bus runs are required to transport this population to reception centers.

To illustrate this estimation procedure, we calculate the number of persons, P, requiring public transit or ride-share, and the number of buses, B, required for the STP EPZ:

$$P = 1,208 \times (0.053 \times 1.96 + 0.312 \times (1.77 - 1) \times 0.49 \times 0.30 + 0.421 \times (2.51 - 2) \times (0.49 \times 0.3)^2)$$

$$P = 1,208 * (0.144) = 175$$

$$B = (0.5 \times P) \div 30 = 3$$

These calculations are explained as follows:

- All members of households (HH) with no vehicles (5.3%) will evacuate by public transit or ride-share. The term 1,208 (total households) x 0.053 x 1.96, accounts for these people.
- The members of HH with 1 vehicle away (31.2%), who are at home, equal (1.77-1). The number of HH where the commuter will not return home is equal to (1,208 x 0.312 x 0.49 x 0.30), where 49% is the percentage of households with at least 1 commuter and 30% is the percentage of households who will not await the return of a commuter before evacuating. The number of persons who will evacuate by public transit or ride-share is equal to the product of these two terms.
- The members of HH with 2 vehicles that are away (42.1%), who are at home, equal (2.51 - 2). The number of HH where neither commuter will return home is equal to 1,208 x 0.421 x (0.49 x 0.30)<sup>2</sup>. The number of persons who will evacuate by public transit or ride-share is equal to the product of these two terms. (The last term is squared to represent the probability that neither commuter will return).
- Households with 3 or more vehicles are assumed to have no need for transit vehicles.
- The total number of persons requiring public transit is the sum of such people in HH with no vehicles, or with 1 or 2 vehicles that are away from home.

## 8.2 School Population – Transit Demand

Table 8-2 presents the school population and transportation requirements for the direct evacuation of all schools within the EPZ. The column in Table 8-2 entitled “Bus Runs Required” specifies the number of buses required for each school under the following set of assumptions and estimates:

- No students will be picked up by their parents prior to the arrival of the buses.

- Bus capacity, expressed in students per bus, is set to 70 for primary schools and 50 for middle and high schools.
- Those staff members who do not accompany the students will evacuate in their private vehicles.
- No allowance is made for student absenteeism that is in the neighborhood of 3 percent, daily.

Table 8-3 presents a list of the relocation schools for each school in the EPZ. Those students not picked up at school by their parents prior to the arrival of the buses, will be transported to these centers where they will be subsequently retrieved by their respective families.

### 8.3 Evacuation Time Estimates for Transit-Dependent People

In the event that the allocation of buses dispatched from the depots to service the transit-dependents is somewhat “inefficient”, or if there is a shortfall of available drivers, then there may be a need for some buses to return to the EPZ from the reception center after completing their first evacuation trip, to complete a “second wave” of providing transport service to evacuees. For this reason, the ETE for the transit dependent population will be calculated for both a one wave transit evacuation and for two waves (Table 8-6). Of course, if the impacted Evacuation Region is other than R03 (the entire EPZ), then there will likely be ample transit resources relative to demand in the impacted Region and this discussion of a second wave would likely not apply.

Transit resources will be assigned to schools as a first priority. When these needs are satisfied, subsequent assignments of buses to service the transit-dependent should be sensitive to their mobilization time. Clearly, the buses should be dispatched after people have completed their mobilization activities and are in a position to board the buses when they arrive at the pick-up points.

Evacuation Time Estimates for Transit Trips were developed using both good weather and adverse weather conditions. Figure 8-1 presents the chronology of events relevant to transit operations. The elapsed time for each activity will now be discussed with reference to Figure 8-1.

#### Activity: Mobilize Drivers (A→ B→C)

Mobilization is the elapsed time from the Advisory to Evacuate until the time the buses have arrived at the facility to be evacuated. It is assumed based on discussions with representatives of STP that for a rapidly escalating radiological emergency with no observable indication before the fact, drivers would likely require 30 minutes to mobilize for school evacuation because they either remain at or near the school throughout the day. Mobilization time is slightly longer – 35 minutes – when raining.

### Activity: Board Passengers (C→D)

Studies have shown that passengers can board a bus at headways of 2-4 seconds (Ref. HCM2000 Page 27-27). Therefore, the total dwell time to service passengers boarding a bus to capacity at a single stop (e.g., at a school) is about 5 minutes. A loading time of 10 minutes will be used for rain scenarios. For multiple stops along a pick-up route we must allow for the additional delay associated with stopping and starting at each pick-up point. This additional delay to service passengers expands this estimate of **aggregated** boarding time to 15 minutes in good weather, and 20 minutes in rain.

The time,  $t$ , required for a bus to decelerate at a rate, “ $a$ ”, expressed in ft/sec/sec, from a speed, “ $v$ ”, expressed in ft/sec, to a stop, is  $t = v/a$ . Assuming the same acceleration rate and final speed following the stop yields a total time,  $T$ , to service boarding passengers:

$$T = t + B + t = B + 2t = B + \frac{2v}{a},$$

Where  $B$  = Dwell time to service passengers. The total distance, “ $s$ ” in feet, travelled during the deceleration and acceleration activities is:  $s = v^2/a$ . If the bus had not stopped to service passengers, but had continued to travel at speed,  $v$ , then its travel time over the distance,  $s$ , would be:  $s/v$ , or  $(v^2/a)/v = v/a$ . Then the total delay (i.e. pickup time,  $P$ ) to service passengers is:

$$P = T - \frac{v}{a} = B + \frac{v}{a}$$

Assigning reasonable estimates:

- $B = 40$  seconds: a generous value for two passengers, carrying personal items, to board per stop
- $v = 50$  mph = 74 ft/sec (consistent with speeds discussed below)
- $a = 4$  ft/sec/sec, a moderate average rate

Then,  $P \approx 1$  minute per stop. Allowing 15 minutes pick-up time per bus run implies 15 stops per run, for good weather. It is assumed that bus acceleration and speed will be less in rain; loading time is 20 minutes per bus in rain.



Activity: Travel to EPZ Boundary (D→E)

School Evacuation

The distance from a school to the EPZ boundary is measured using Geographical Information Systems (GIS) software along the most likely route out of the EPZ. The measurements are divided between those distances traveled on local roads and those distances traveled on major routes.

The Tidehaven Middle and High Schools both evacuate to the Markham and Blessing Elementary Schools. It is assumed that for both Tidehaven schools, an equal number of buses go to Markham and Blessing.

The UNITES software discussed in Section 1.3 was used to define bus routes along the most likely path from a school being evacuated to the EPZ boundary, traveling toward the appropriate reception center. This is done in UNITES by interactively selecting the series of nodes from the school to the EPZ boundary. The bus route is given an identification number and is written to the I-DYNEV input stream. UNITES computes the route length and DYNEV outputs the average speed for each 10 minute interval for each bus route input. The bus routes input are documented in Table 8-4 (refer to the figures in Appendix K for node locations). Data from 30 to 40 minutes after the advisory to evacuate were used for all schools in the EPZ. The average speed along the path using these data generated by DNYEV was computed as follows:

$$\text{Average Speed} \left( \frac{\text{mi.}}{\text{hr.}} \right) = \left( \frac{\sum_{i=1}^n \text{length of link } i \text{ (mi)}}{\sum_{i=1}^n \text{Delay on link } i \text{ (min.)} + \frac{\text{length of link } i \text{ (mi.)}}{\text{free flow speed on link } i \left( \frac{\text{mi.}}{\text{hr.}} \right)} \times \frac{60 \text{ min.}}{1 \text{ hr.}}} \right) \times \frac{60 \text{ min.}}{1 \text{ hr.}}$$

Tables 8-5A and B show the average speed computed (using this methodology) for the buses servicing each of the schools in the EPZ. The travel time to the EPZ boundary was computed for each school using the computed average speed and the distance to the EPZ boundary along the most likely route out of the EPZ. The travel time from the EPZ boundary to the Reception Center was computed assuming an average speed of 50 mph and 45 mph for good weather and rain respectively.

Texas state law restricts buses from traveling at speeds in excess of 50 mph on roads that are not U.S. or Texas State Routes, and 60 mph otherwise. To be conservative, if the computed speeds exceeded 50 mph, we adjusted speed to 50 mph (45 mph in rain), regardless of which road they are traveling on.

Tables 8-5A (good weather) and 8-5B (rain) present the following evacuation time estimates (rounded up to the nearest 5 minutes) for schools in the EPZ: (1) The elapsed time from the Advisory to Evacuate until the bus exits the EPZ; and (2) The elapsed time until the bus reaches the School Reception Center. The evacuation time out of the EPZ can be computed as the sum of travel times associated with Activities A→B→C, C→D, and D→E (For example: 30 min.+ 5 + 20 = 1:00 [rounded-up] for Matagorda Elementary School, with good weather). The evacuation time to the School Reception Center is determined by adding the time associated with Activity E→F (discussed below), to this EPZ evacuation time.

### Evacuation of Transit-Dependent Population

The buses that are dispatched to service the transit-dependent evacuees should be scheduled so that they arrive at their respective routes after their passengers have completed their mobilization. According to telephone survey results, 80% of the population not waiting for commuters to return home would be ready to evacuate 2 hours and 30 minutes after the Advisory to Evacuate. Some residents without commuters have mobilization times up to 5 hours (Chapter 5), therefore efforts to minimize the mobilization time of transit dependent residents through public education or by making telephone contact prior to pick-up, could greatly help the evacuation effort. A detailed transit-dependent evacuation plan should be established by county officials.

Buses servicing the transit-dependent evacuees will first travel along their pick-up routes, then proceed out of the EPZ. Table 8-6 details the proposed bus routes to service the transit dependent people in the STP EPZ, while Figure 8-2 maps the proposed bus pick-up routes. The travel distance along the respective pick-up routes within the EPZ is measured using GIS software. Most of the evacuation traffic will have dissipated when the transit dependent buses begin their routes; however the frequent stops for passenger pickup will slow the buses down. The delay associated with the deceleration and stopping of buses to pick up passengers is factored into the loading time, as discussed above. The associated travel times along the routes are computed using the route length and the average route speeds output by DYNEV, as discussed above.

Assuming that buses arrive at their first pick-up points 2 hours and 30 minutes (2 hours and 45 minutes for rain) after the Advisory to Evacuate, Table 8-7 presents the transit-dependent population evacuation time estimates for each route obtained using the above procedures. For example, the ETE for Route 1 is computed as  $150 + 15 + 7.6 = 2:55$  hours for good weather. Here, 7.6 minutes is the time to travel 6.3 miles at 50 mph. The ETE for a second wave (discussed below) is presented in the event there is a shortfall of available buses or bus drivers.

### Activity: Travel to Reception Centers (E→F)

The distances from the EPZ boundary to the reception centers are also measured using Geographical Information Systems (GIS) software along the most likely route from the EPZ to the reception center. For a one-wave evacuation, this travel time outside the EPZ does not contribute to the ETE. For a two-wave evacuation, the ETE for buses must be considered separately, since it could exceed the ETE for the general public. There are sufficient bus resources to evacuate the schools in a single wave, based on discussions with representatives of STP and Matagorda County; thus, a two-wave evacuation time for schools has not been estimated. Two-wave ETE have been generated for transit-dependent buses, although it is unlikely that a second wave will be required. The bus speeds that are used for this calculation are the resulting average speeds for each transit route output by DYNEV.

### Activity: Passengers Leave Bus (F→G)

Passengers can disembark within 5 minutes. The bus driver will take a 15 minute break.

### Activity: Bus Returns to Route for Second Wave Evacuation (G→C)

The buses assigned to return to the EPZ to perform a “second wave” evacuation of transit-dependent evacuees will be those that evacuated the school children. These buses are assigned since they will be the first buses to complete their evacuation service and are therefore the first to be available for the second wave. The schoolchildren depart the bus, and the bus then returns to the EPZ, travels to its route and proceeds to pick up transit-dependent evacuees along the route. The travel time back to the EPZ is calculated using distances estimated from GIS and the assumed bus travel speeds.

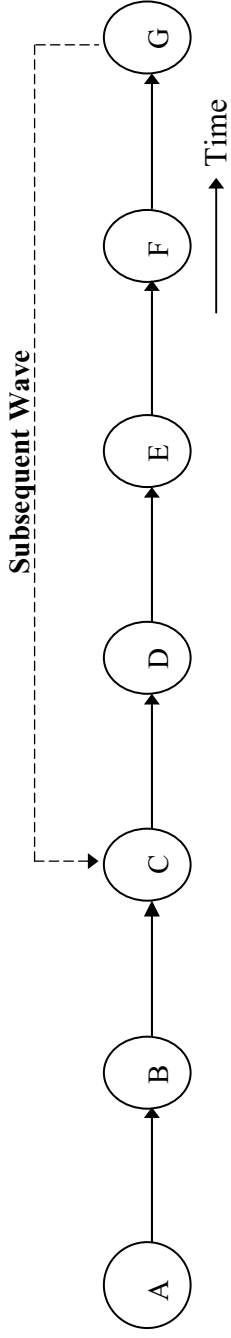
The travel time for Route Number 1 is computed as follows:

- Bus arrives at reception center at 0:50 on average in good weather (Table 8-5A).
- Bus discharges passengers (5 minutes) and driver takes a 15-minute rest: 20 minutes.
- Bus returns to EPZ: 2 minutes on average (Table 8-5A).
- Bus completes pick-ups along route and departs EPZ:  
15 minutes + (6.3 miles @ 50 mph)\*2 [trip to pick-up point then back to EPZ boundary] = 30 minutes.
- Bus exits EPZ at time 0:50 + 0:20 + 0:02 + 0:30= 1:45, (rounded up to nearest 5 minutes) after the Advisory to Evacuate.

The ETE for the completion of the second wave for all transit-dependent bus routes are provided in Table 8-7.

Note that the term “second wave” applies to those buses returning to the EPZ to evacuate the transit-dependent population after evacuating the schoolchildren; chronologically, these buses actually travel the route before the buses that are mobilized from the surrounding areas and identified as the “Single Wave.” It is reasonable to expect that some of the transit-dependent evacuees would take less time to prepare for their walk to the bus route since they are limited to take only those belongings they can physically carry during the walk to the bus route and would be ready to board these earlier buses. As indicated in Table 5-8, more than 30% of residents have mobilized by the time the second wave buses (approximately 75 minutes) will arrive at the routes. Thus, the second traversal of buses along these routes (denoted as the “single wave”), which takes place between 2½ and 3 hours after the Advisory to Evacuate, should service all those transit-dependent people who have not been serviced by the earlier buses. Consequently, the total ETE under good weather according to Table 8-7A is 3:10, while that for the rain scenario (Table 8-7B) is 3:45. The county may elect to schedule these two waves so that they service the transit-dependent at different times, thereby providing a broad coverage of service.

The buses that complete the “second wave” will be available for additional assignments at a time roughly 2 hours after the Advisory to Evacuate. These buses can then be deployed as needed to service the homebound people who have no private vehicles, nor the ability to walk to the pickup routes. Over the period of 2 hours following the Advisory to Evacuate, it is reasonable to assume that the homebound transit-dependent will have made their needs known through telephone communication; this would allow responder agencies to compile a schedule of pickups as needed. These buses can then be dispatched after their second wave is completed to pick up the remaining people within the EPZ. The estimated ETE of 3:10 shown in Table 8-7A will therefore account for this pickup of homebound transit-dependent, as well, since this third sweep should not take materially longer than 1 hour. The implementation details are the responsibility of the emergency response agencies and are not considered explicitly in the ETE.



**Event**

- A Advisory to Evacuate
- B Bus Dispatched from Depot
- C Bus Arrives at Facility/Pick-up Route
- D Bus Departs for Reception Center
- E Bus Exits Region
- F Bus Arrives at School Reception Center
- G Bus Available for "Second Wave" Evacuation Service

**Activity**

- A→B Driver Mobilization
- B→C Travel to Facility or to Pick-up Route
- C→D Passengers Board the Bus
- D→E Bus Travels Towards Region Boundary
- E→F Bus Travels Towards School Reception Center Outside the EPZ.
- F→G Passengers Leave Bus; Driver Takes a Break

**Figure 8-1. Chronology of Transit Evacuation Operations**

<b>Table 8-1. Transit Dependent Population Estimates</b>														
Facility Name	2007 EPZ Population	Survey Average Household Size With Indicated No. of Vehicles			Estimated Number of Households	Survey Percent Households With			Survey Percent Households With Commuters	Survey Percent Households With Non-Returning Commuters	Total People Requiring Transport	Estimated Ridesharing Percentage	People Requiring Public Transit	Percent of Population Requiring Public Transit
		0	1	2		0 Vehicle	1 Vehicle	2 Vehicle						
South Texas Project	2,875	1.96	1.77	2.51	1,208	5.3%	31.2%	42.1%	49%	30%	175	50%	88	3.1%

Table 8-2. School Population Demand Estimates							
Zone	Distance (miles)	Direction	School Name	Municipality	Enrollment	Staff	Bus Runs Required
<b>Matagorda County Schools within EPZ</b>							
7	8.5	SE	Matagorda Elementary School	Matagorda	70	20	1 (or 2)
10	8.2	NW	Tidehaven Middle School	El Maton	178	25	4
10	9.1	NW	Tidehaven High School	El Maton	271	42	6
<b>Totals:</b>					<b>519</b>	<b>87</b>	<b>11 (or 12)</b>

Table 8-3. School Relocation Schools		
Facility	Zone	Relocation School
<b>High Schools</b>		
Tidehaven High School	10	Markham and Blessing Elementary Schools
<b>Middle Schools</b>		
Tidehaven Middle School	10	Markham and Blessing Elementary Schools
<b>Elementary Schools</b>		
Matagorda Elementary School	7	McAllister Middle School

**Table 8-4. Bus Route Descriptions**

Bus Route Number	Description	Nodes Traversed from Route Start to EPZ Boundary
1	Transit Route 1	98, 93, 94, 100, 1228, 1221, 221, 1178, 220
2	Transit Route 2	900, 901, 902, 850, 851, 1179, 1238, 852, 90, 91, 92, 98, 93, 94, 100, 1228, 1221, 221, 1178, 220
3	Transit Route 3	1200, 1204, 1201, 1205, 1206, 1207, 1208, 1209, 1210, 1211, 1212, 1213, 1214, 1215, 661, 1269, 1267, 1268
4	Tidehaven Middle School to Markham Elementary School	1220, 640, 1168, 1167, 1166, 1262, 1263
5	Tidehaven High School to Markham Elementary School	1216, 640, 1168, 1167, 1166, 1262, 1263
6	Matagorda Elementary School	880, 870, 860, 861, 850, 851, 1179, 1238, 852, 90, 91, 92, 98, 93, 94, 100, 1228, 1221, 221, 1178, 220
7	Tidehaven Middle School to Blessing Elementary School	1220, 640, 1216, 1217, 650, 651, 652, 653, 660, 1267, 1268
8	Tidehaven High School to Blessing Elementary School	640, 1216, 1217, 650, 651, 652, 653, 660, 1267, 1268



**Table 8-5A. School Evacuation Time Estimates - Good Weather**

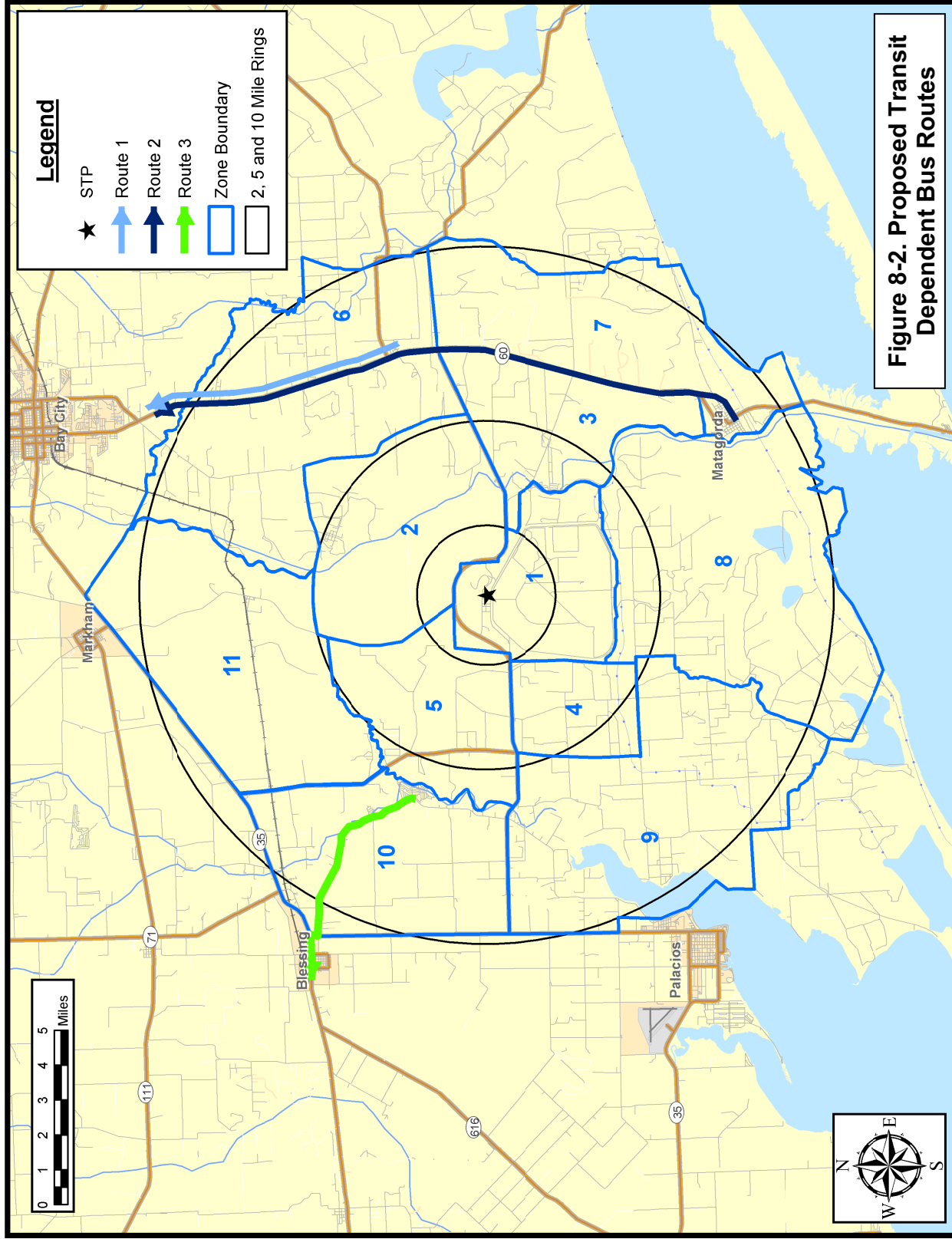
School	Driver Mobilization and Travel Time from Depot(min)	Loading Time (min)	Dist. to EPZ Boundary (mi.)		Average Speed (mph)	Adjusted Speed (mph)	Travel Time to EPZ Bdry (min)	To Bdry ETE (min)	To Bdry ETE (hr:min)	Dist. EPZ Bndry to R.C.		Travel Time EPZ Bdry to RC (min)	ETE to R.C. (min)	ETE to R.C. (hr:min)
			Major Road	Local Road						Major Road	Local Road			
<b>Matagorda County Schools</b>														
Matagorda Elementary School	30	5	15	1.7	54.0	50.0	20.0	60	1:00	1.5	1.4	5	65	1:05
Tidehaven Middle School to Markham E.S.	30	5	7.8	0	59.6	50.0	9.4	45	0:45	0	1.0	2	50	0:50
Tidehaven High School to Markham E.S.	30	5	6.2	0	70.2	50.0	7.4	45	0:45	0	1.0	2	45	0:45
Tidehaven Middle School to Blessing E.S.	30	5	6.4	0	53.9	50.0	7.7	45	0:45	0	0.1	1	45	0:45
Tidehaven High School to Blessing E.S.	30	5	4.8	0	62.6	50.0	5.8	45	0:45	0	0.1	1	45	0:45
<b>ETE rounded up to the nearest 5 minutes</b>								<b>Maximum for EPZ:</b>	<b>60</b>	<b>Maximum:</b>	<b>3</b>	<b>65</b>	<b>1:05</b>	
								<b>Average for EPZ:</b>	<b>50</b>	<b>Average:</b>	<b>2</b>	<b>50</b>	<b>0:50</b>	

**Table 8-5B. School Evacuation Time Estimates - Rain**

School	Driver Mobilization and Travel Time from Depot(min)	Loading Time (min)	Dist. to EPZ Boundary (mi.)		Average Speed (mph)	Adjusted Speed (mph)	Travel Time to EPZ Bdry (min)	To Bdry ETE (min)	To Bdry ETE (hr:min)	Dist. EPZ Bndry to R.C.		Travel Time EPZ Bdry to RC (min)	ETE to R.C. (min)	ETE to R.C. (hr:min)
			Major Road	Local Road						Major Road	Local Road			
<b>Matagorda County Schools</b>														
Matagorda Elementary School	30	10	15	1.7	48.9	45.0	22.3	65	1:05	1.5	1.4	6	70	1:10
Tidehaven Middle School to Markham E.S.	30	10	7.8	0	53.3	45.0	10.4	55	0:55	0	1.0	3	55	0:55
Tidehaven High School to Markham E.S.	30	10	6.2	0	62.7	45.0	8.3	50	0:50	0	1.0	3	55	0:55
Tidehaven Middle School to Blessing E.S.	30	10	6.4	0	48.7	45.0	8.5	50	0:50	0	0.1	1	50	0:50
Tidehaven High School to Blessing E.S.	30	10	4.8	0	56.8	45.0	6.4	50	0:50	0	0.1	1	50	0:50
<b>ETE rounded up to the nearest 5 minutes</b>								<b>Maximum for EPZ:</b>	<b>65</b>	<b>Maximum:</b>	<b>3</b>	<b>70</b>	<b>1:10</b>	
								<b>Average for EPZ:</b>	<b>54</b>	<b>Average:</b>	<b>3</b>	<b>60</b>	<b>1:00</b>	

**Table 8-6. Summary of Transit Dependent Bus Routes**

<b>Route Number</b>	<b>Number of Buses</b>	<b>Route Description</b>	<b>Length (Miles to EPZ Boundary)</b>
1	1	State Hwy 60 northbound from Wadsworth, out of the EPZ toward Bay City.	6.3
2	1	State Hwy 60 from Fisher St, Matagorda, north out of the EPZ toward Bay City.	17.0
3	1	FM 2853 northbound from Ashby out of EPZ toward Blessing.	5.5



**Figure 8-2. Proposed Transit  
Dependent Bus Routes**

Table 8-7A. Transit-Dependent Evacuation Time Estimates - GOOD WEATHER

Route Number	Single Wave						Second Wave (After School Evacuation)													
	Mobilization and Travel Time to EPZ	Route Length (mi.)	Average Speed (mph)	Adjusted Speed (mph)	Run Travel Time	Pickup Time	ETE (min)	ETE (hr:min)	Arrive at RC	Unload	Driver Rest	Return to EPZ	Average Speed (mph)	Adjusted Speed (mph)	Run Travel Time	Pickup Time	ETE (min)	ETE (hr:min)		
1	150	6.3	63.4	50.0	7.6	15	175	2:55	50	5	15	2	63.4	50.0	15.12	15	105	1:45		
2	150	17.0	50.0	50.0	20.4	15	190	3:10	50	5	15	2	50.0	50.0	40.8	15	130	2:10		
3	150	5.5	53.1	50.0	6.6	15	175	2:55	50	5	15	2	53.1	50.0	13.2	15	105	1:45		
						Maximum for EPZ:	190	3:10							Maximum for EPZ:	130	2:10			
						Average for EPZ:	180	3:00							Average for EPZ:	115	1:55			

Table 8-7B. Transit-Dependent Evacuation Time Estimates - RAIN

Route Number	Single Wave						Second Wave (After School Evacuation)													
	Mobilization and Travel Time to EPZ	Route Length (mi.)	Average Speed (mph)	Adjusted Speed (mph)	Run Travel Time	Pickup Time	ETE (min)	ETE (hr:min)	Arrive at RC	Unload	Driver Rest	Return to EPZ	Average Speed (mph)	Adjusted Speed (mph)	Run Travel Time	Pickup Time	ETE (min)	ETE (hr:min)		
1	165	6.3	56.9	45.0	14	20	200	3:20	56	10	15	3	56.9	45	28	20	135	2:15		
2	165	17.0	45.5	45.0	38	20	225	3:45	56	10	15	3	45.47	45	76	20	180	3:00		
3	165	5.5	48.0	45.0	12	20	200	3:20	56	10	15	3	48.04	45	24	20	130	2:10		
						Maximum for EPZ:	225	3:45							Maximum for EPZ:	180	3:00			
						Average for EPZ:	210	3:30							Average for EPZ:	150	2:30			

## 9. TRAFFIC MANAGEMENT STRATEGY

This section presents the current traffic control and management strategy that is designed to expedite the movement of evacuating traffic. The resources required to implement this strategy include:

- Personnel with the capabilities of performing the planned control functions of traffic guides.
- Equipment to assist these personnel in the performance of their tasks:
  - Traffic Barriers
  - Traffic Cones
  - Signs
- A plan that defines all necessary details and is documented in a format that is readily understood.

The functions to be performed in the field are:

1. Facilitate evacuating traffic movements that serve to expedite travel out of the EPZ along routes that the analysis has found to be most effective.
2. Discourage traffic movements that permit evacuating vehicles to travel in a direction which takes them significantly closer to the power station, or which interferes with the efficient flow of other evacuees.

We employ the terms "facilitate" and "discourage" rather than "enforce" and "prohibit" to indicate the need for flexibility in performing the traffic control function. There are always legitimate reasons for a driver to prefer a direction other than that indicated. For example:

- A driver may be traveling home from work or from another location, to join other family members prior to evacuating.
- An evacuating driver may be taking a detour from the evacuation route in order to pick up a relative.
- The driver may be an emergency worker en route to perform an important activity.

The implementation of a plan must also be flexible enough for the application of sound judgment by the traffic guide.

The traffic management strategy is the outcome of the following process:

1. A field survey of these critical locations.  
The schematics of Appendix G are based on data collected during field surveys, upon large-scale maps, and on overhead imagery.
2. Consultation with emergency management and enforcement personnel.  
Trained personnel who are experienced in controlling traffic and who are

familiar with the likely traffic patterns should review these control tactics.

3. Prioritization of TCPs.

Application of traffic control at some TCPs will have a more pronounced influence on expediting traffic movements. Thus, during the mobilization of personnel to respond to the emergency situation, those TCPs, which are assigned a higher priority, will be manned earlier. This setting of priorities should be undertaken with the concurrence of emergency management and law enforcement personnel. These priorities should be compatible with the availability of local manpower resources.

In each schematic that appears in Appendix G, the control tactic at each TCP is presented.

The use of Intelligent Transportation Systems (ITS) technologies will benefit the evacuation process. Dynamic Message Signs (DMS) can be placed within the EPZ to provide information to travelers regarding traffic conditions, route selection, and reception center information. DMS can also be placed outside of the EPZ to warn motorists to avoid using routes that may conflict with the flow of evacuees away from the South Texas Project electric generating station. Highway Advisory Radio (HAR) can be used to broadcast information to evacuees enroute through their vehicle stereo systems. Automated Traveler Information Systems (ATIS) can also be used to provide evacuees with information. Internet websites can provide traffic and evacuation route information before the evacuee begins his trip, while on board navigation systems (GPS units), cell phones, and pagers can be used to provide information enroute. These are only several examples of how ITS technologies can benefit the evacuation process.

## 10. EVACUATION ROUTES

Evacuation routes are composed of two distinct components:

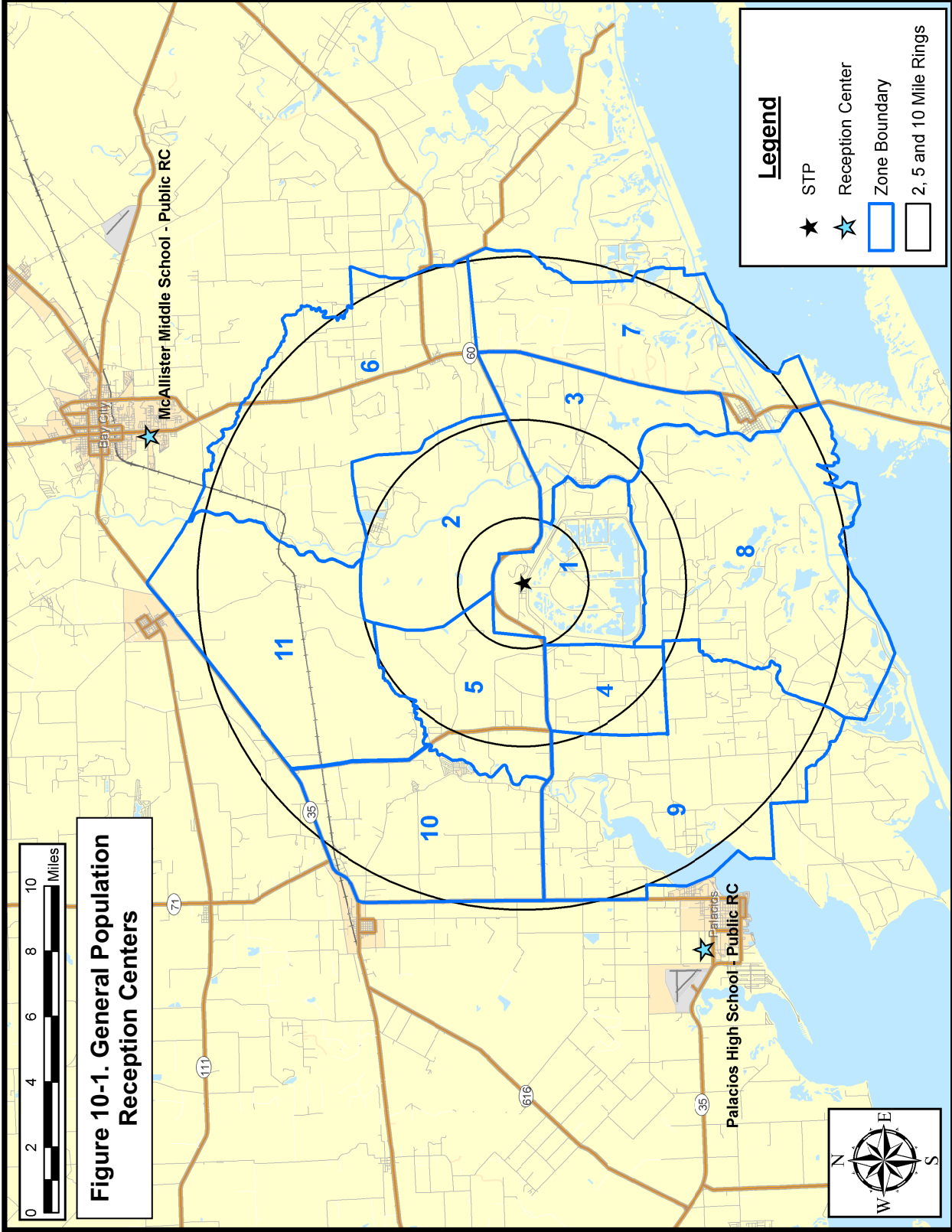
- Routing from a Zone being evacuated to the boundary of the Evacuation Region and then out of the Emergency Planning Zone (EPZ).
- Routing of evacuees from the EPZ boundary to the reception centers.

Evacuees should be routed within the EPZ in such a way as to *minimize their exposure to risk*. This primary requirement is met by routing traffic to move away from the location of the South Texas Project (STP), to the extent practicable, and by delineating evacuation routes that expedite the movement of evacuating vehicles. This latter objective is addressed by developing evacuation routes to achieve a balancing of traffic demand relative to the available highway capacity to the extent possible, subject to satisfying the primary requirement noted above. This is achieved by carefully specifying candidate destinations for all origin centroids where evacuation trips are generated, and applying the TRAD model effectively. See Appendices A-D for further discussion.

The routing of evacuees from the EPZ boundary to the reception centers should be responsive to several considerations:

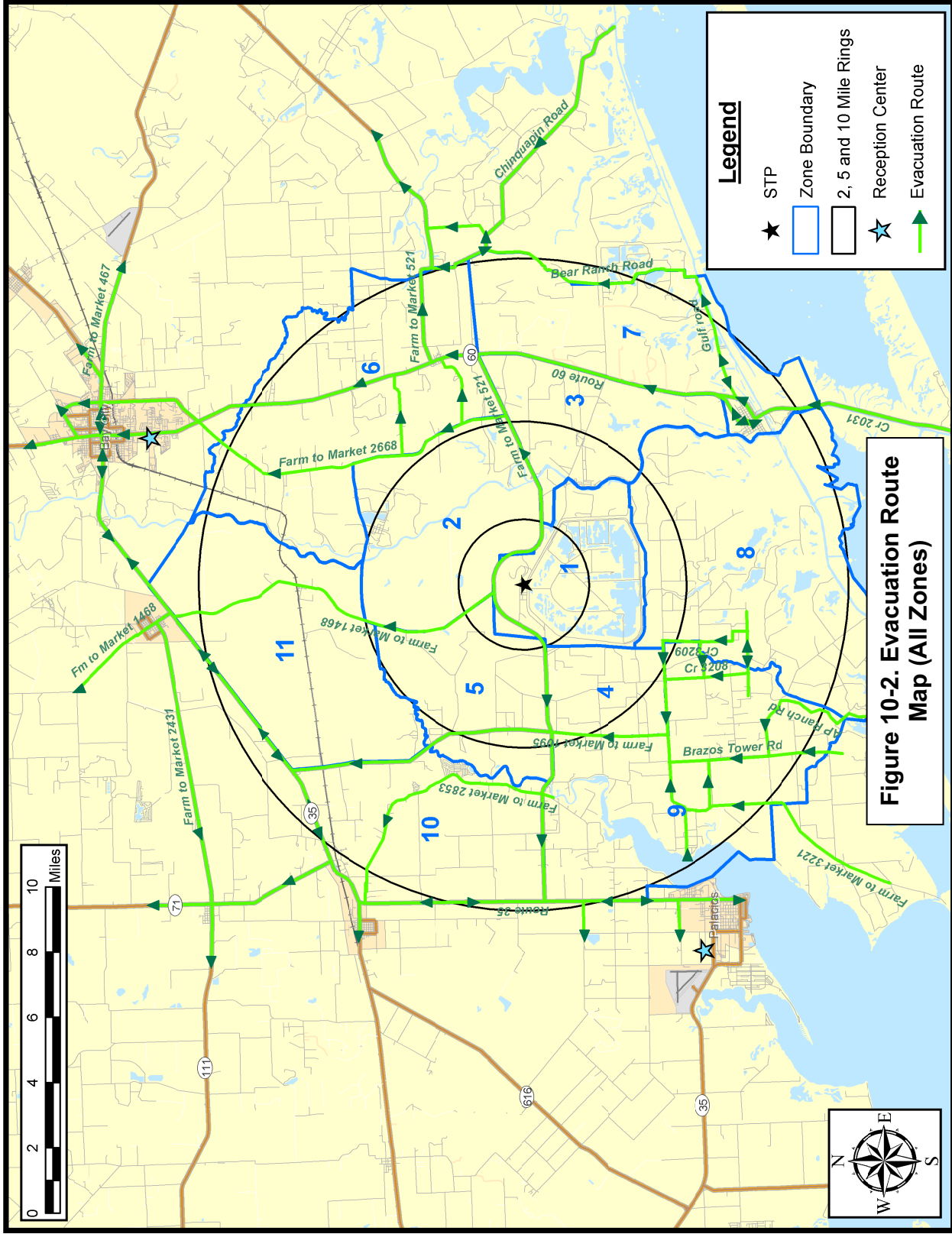
- Minimize the amount of travel outside the EPZ, from the points where these routes cross the EPZ boundary, to the reception centers.
- Relate the anticipated volume of traffic destined to the reception center, to the capacity of the reception center facility.

Figure 10-1 presents a map showing the general population reception centers. The major evacuation routes are presented in Figure 10-2.



**Figure 10-1. General Population Reception Centers**





**Figure 10-2. Evacuation Route Map (All Zones)**

**Legend**

- ★ STP
- ★ Reception Center
- Zone Boundary
- 2, 5 and 10 Mile Rings
- Evacuation Route

## 11. SURVEILLANCE OF EVACUATION OPERATIONS

There is a need for surveillance of traffic operations during the evacuation. There is also a need to clear any blockage of roadways arising from accidents or vehicle disablement. Surveillance can take several forms.

1. Traffic control personnel, located at Traffic Control Points, provide fixed-point surveillance.
2. Ground patrols may be undertaken along well-defined paths to ensure coverage of those highways that serve as major evacuation routes.
3. Aerial surveillance of evacuation operations may also be conducted using helicopter or fixed-wing aircraft.
4. Cellular phone calls from motorists, if service is available, may also provide direct field reports of road blockages.

These concurrent surveillance procedures are designed to provide coverage of the entire EPZ as well as the area around its periphery. It is the responsibility of Matagorda County to support a communication system that can receive messages from the field and be in a position to respond to any reported problems in a timely manner. This coverage should quickly identify, and expedite the response to any blockage caused by a disabled vehicle.

In a low-speed traffic environment, any vehicle disablement is likely to arise due to a low-speed collision, mechanical failure or the exhaustion of its fuel supply. In any case, the disabled vehicle can be pushed onto the shoulder, thereby restoring traffic flow. Past experience in other emergencies indicates that evacuees who are leaving an area often perform activities such as pushing a disabled vehicle to the side of the road without prompting.

### Tow Vehicles

While the need for tow vehicles is expected to be low under the circumstances described above, it is still prudent to be prepared for such a need. Tow trucks may be deployed at strategic locations within, or just outside, the EPZ. These locations should be selected so that:

- They permit access to key, heavily loaded, evacuation routes.
- Responding tow trucks would most likely travel counter-flow relative to evacuating traffic.

## 12. CONFIRMATION TIME

It is necessary to confirm that the evacuation process is effective in the sense that the public is complying with the Advisory to Evacuate. Although Matagorda County may use its own procedures for confirmation, we suggest an alternative or complementary approach.

The procedure we suggest employs a stratified random sample and a telephone survey. The size of the sample is dependent on the expected number of households that do not comply with the Advisory to Evacuate. We believe it is reasonable to assume, for the purpose of estimating sample size that at least 80 percent of the population within the EPZ will comply with the Advisory to Evacuate. On this basis, an analysis could be undertaken (see Table 12-1) to yield an estimated sample size of approximately 250.

The confirmation process should start at about 150 minutes after the Advisory to Evacuate, which is after the mobilization activities are completed for the majority of residents (see Table 5-1). At this time, virtually all evacuees will have departed on their respective trips and the local telephone system will be largely free of traffic.

As indicated in Table 12-1, approximately 7 person hours are needed to complete the telephone survey. If six people are assigned to this task, each dialing a different set of telephone exchanges (e.g., each person can be assigned a different set of Zones), then the confirmation process will extend over a time frame of about 70 minutes. Thus, the confirmation should be completed well before the evacuated area is cleared. Of course, fewer people would be needed for this survey if the Evacuation Region were only a portion of the EPZ. Use of modern automated computer controlled dialing equipment can significantly reduce the manpower requirements and the time required to undertake this type of confirmation survey.

Should the number of telephone responses (i.e., people still at home) exceed 20 percent, then the telephone survey should be repeated after an hour's interval until the confirmation process is completed.

TABLE 12-1  
ESTIMATED NUMBER OF TELEPHONE CALLS REQUIRED  
FOR CONFIRMATION OF EVACUATION

Problem Definition

Estimate number of phone calls, n, needed to ascertain the proportion, F of households that have not evacuated.

Reference: Burstein, H., Attribute Sampling, McGraw Hill, 1971

Given:

No. of households plus other facilities, N, within the EPZ (est.) = 1,210  
Est. proportion, F of households that will not evacuate = 0.20  
Allowable error margin, e: 0.05  
Confidence level,  $\alpha$ : 0.95 (implies A = 1.96)

Applying Table 10 of cited reference,

$$p = F + e = 0.25; \quad q = 1 - p = 0.75$$

$$n = \frac{A^2 pq + e}{e^2} = 308$$

Finite population correction:

$$n_F = \frac{nN}{n + N - 1} = 246$$

Thus, some 246 telephone calls will confirm that approximately 20 percent of the population has not evacuated. If only 10 percent of the population does not comply with the Advisory to Evacuate, then the required sample size,  $n_F = 184$ .

Est. Person Hours to complete 250 telephone calls

Assume: Time to dial using touch-tone (random selection of listed numbers): 30 seconds  
Time for 8 rings (no answer): 48 seconds  
Time for 4 rings plus short conversation: 60 sec.  
Interval between calls: 20 sec.

Person Hours:  $250[30+20+0.8(48)+0.2(60)]/3600 = 7.0$

### 13. RECOMMENDATIONS AND CONCLUSIONS

The following recommendations are offered:

1. The traffic management plan has been reviewed by state and county emergency planners with local and state police (See Section 9 and Appendix G). Specifically...
  - The number and locations of Traffic Control Points (TCP) have been reviewed in detail.
  - The indicated resource requirements (personnel, cones, barriers, etc.) have been reconciled with current assets.
2. Intelligent Transportation Systems (ITS) such as Dynamic Message Signs (DMS), Highway Advisory Radio (HAR), Automated Traveler Information Systems (ATIS), etc. should be used to facilitate the evacuation process (See Section 9). The placement of additional signage should consider evacuation needs.
3. Matagorda County should implement procedures whereby schools are contacted prior to the dispatch of buses from the depots to get an accurate count of students needing transportation and the number of buses required (See Section 8).
4. Matagorda County should establish strategic locations to position tow trucks in the event of a disabled vehicle during the evacuation process (See Section 11) and should encourage gas stations to remain open during the evacuation.
5. Matagorda County should establish a system to confirm that the Advisory to Evacuate is being adhered to (see the approach suggested by KLD in Section 12).
6. Examination of the ETE in Appendix J shows that the ETE for 100 percent of the population is 2-3 hours longer than for 95 percent of the population. Specifically, the additional time needed for the last 5 percent of the population to evacuate can be as much as 50 percent more than the time needed to evacuate 95 percent of the population. This non-linearity reflects the fact that these relatively few stragglers require significantly more time to mobilize (i.e. prepare for the evacuation trip) than their neighbors. This leads to two recommendations:
  - The public outreach (information) program should emphasize the need for evacuees to minimize the time needed to prepare to evacuate (secure the home, assemble needed clothes, medicines, etc.).
  - **The decision makers should reference Table J-1C which lists the time needed to evacuate 95 percent of the population, when preparing recommended protective actions.**

## APPENDIX A

### Glossary of Traffic Engineering Terms

APPENDIX A: GLOSSARY OF TRAFFIC ENGINEERING TERMS

<b>Term</b>	<b>Definition</b>
Link	A network link represents a specific, one-directional section of roadway. A link has both physical (length, number of lanes, topology, etc.) and operational (turn movement percentages, service rate, free-flow speed) characteristics.
Measures of Effectiveness	Statistics describing traffic operations on a roadway network
Node	A network node generally represents an intersection of network links. A node has control characteristics, i.e., the allocation of service time to each approach link.
Origin	A location attached to a network link, within the EPZ or shadow area, where trips are generated at a specified rate in vehicles per hour (vph). These trips enter the roadway system to travel to their respective destinations.
Network	A graphical representation of the geometric topology of a physical roadway system, which is comprised of directional links and nodes.
Prevailing roadway and traffic conditions	Relates to the physical features of the roadway, the nature (e.g., composition) of traffic on the roadway and the ambient conditions (weather, visibility, pavement conditions, etc.)
Service Rate	Maximum rate at which vehicles, executing a specific turn maneuver, can be discharged from a section of roadway at the prevailing conditions, expressed in vehicles per second (vps) or vehicles per hour (vph).
Service Volume	Maximum number of vehicles which can pass over a section of roadway in one direction during a specified time period with operating conditions at a specified Level of Service (The Service Volume at the upper bound of Level of Service, E, equals Capacity). Service Volume is usually expressed as vehicles per hour (vph).
Signal Cycle Length	The total elapsed time to display all signal indications, in sequence. The cycle length is expressed in seconds.
Signal Interval	A single combination of signal indications. The interval duration is expressed in seconds. A signal phase is comprised of a sequence of signal intervals.
Signal Phase	A set of signal indications (and intervals) which services a particular combination of traffic movements on selected approaches to the intersection. The phase duration is expressed in seconds.

<b>Term</b>	<b>Definition</b>
Traffic (Trip) Assignment	A process of assigning traffic to paths of travel in such a way as to satisfy all trip objectives (i.e., the desire of each vehicle to travel from a specified origin in the network to a specified destination) and to optimize some stated objective or combination of objectives. In general, the objective is stated in terms of minimizing a generalized "cost". For example, "cost" may be expressed in terms of travel time.
Traffic Density	The number of vehicles that occupy one lane of a roadway section of specified length at a point in time, expressed as vehicles per mile (vpm).
Traffic (Trip) Distribution	A process for determining the destinations of all traffic generated at the origins. The result often takes the form of a Trip Table, which is a matrix of origin-destination traffic volumes.
Traffic Simulation	A computer model designed to replicate the real-world operation of vehicles on a roadway network, so as to provide statistics describing traffic performance. These statistics are called Measures of Effectiveness.
Traffic Volume	The number of vehicles that pass over a section of roadway in one direction, expressed in vehicles per hour (vph). Where applicable, traffic volume may be stratified by turn movement.
Travel Mode	Distinguishes between private auto, bus, rail, pedestrian and air travel modes.
Trip Table or Origin-Destination Matrix	A rectangular matrix or table, whose entries contain the number of trips generated at each specified origin, during a specified time period, that are attracted to (and travel toward) each of its specified destinations. These values are expressed in vehicles per hour (vph) or in vehicles.
Turning Capacity	The capacity associated with that component of the traffic stream which executes a specified turn maneuver from an approach at an intersection.



## APPENDIX B

### Traffic Assignment Model

## APPENDIX B: TRAFFIC ASSIGNMENT MODEL

This section describes the integrated trip assignment and distribution model named TRAD that is expressly designed for use in analyzing evacuation scenarios. This model employs equilibrium traffic assignment principles and is one of the models of the IDYNEV System.

To apply TRAD, the analyst must specify the highway network, link capacity information, the volume of traffic generated at all origin centroids, a set of accessible candidate destination nodes on the periphery of the EPZ for each origin, and the capacity (i.e., “attraction”) of each destination node. TRAD calculates the optimal trip distribution and the optimal trip assignment (i.e., routing) of the traffic generated at each origin node, traveling to the associated set of candidate destination nodes, so as to minimize evacuee travel times.

### Overview of Integrated Distribution and Assignment Model

The underlying premise is that the selection of destinations and routes is intrinsically coupled in an evacuation scenario. That is, people in vehicles seek to travel out of an area of potential risk as rapidly as possible by selecting the “best” route. The model is designed to identify these “best” routes in a manner that distributes vehicles from origins to destinations and routes them over the highway network, in a consistent and optimal manner.

The approach we adopt is to extend the basic equilibrium assignment methodology to embrace the distribution process, as well. That is, the selection of destination nodes by travelers from each origin node, and the selection of the connecting paths of travel, are both determined by the integrated model. This determination is subject to specified capacity constraints, so as to satisfy the stated objective function. This objective function is the statement of the User Optimization Principle by Wardrop<sup>1</sup>.

To accomplish this integration, we leave the equilibrium assignment model intact, changing only the form of the objective function. It will also be necessary to create a “fictional” augmentation of the highway network. This augmentation will consist of Pseudo-Links and Pseudo-Nodes, so configured as to embed an equilibrium Distribution Model within the fabric of the Assignment Model.

---

<sup>1</sup> Wardrop, J.G., 1952. Some Theoretical Aspects of Road Traffic Research, *Proceedings, Institute of Civil Engineers*, Part II, Vol. 1, pp. 325-378.

## Specification of TRAD Model Inputs

The user must specify, for each origin node, the average hourly traffic volume generated, as well as a set of candidate accessible destinations. A destination is “accessible” to traffic originating at an origin node if there is at least one path connecting the origin to the destination node. There must be at least one destination node specified for each origin centroid. The number of trips generated at the origin node, which are distributed to each specified, accessible destination node within this set, is determined by the model in a way as to satisfy the network-wide objective function (Wardrop's Principle).

The user must also specify the total number of trips which can be accommodated by each destination node. This value reflects the capacities of the road(s) immediately servicing the destination node. We call this number of trips, the "attraction" of the destination node, consistent with conventional practice. Clearly, we require that the total number of trips traveling to a destination,  $j$ , from all origin nodes,  $i$ , cannot exceed the attraction of destination node,  $j$ . By summing over all destination nodes, this constraint also states that the total trips generated at all origin nodes must not exceed the total capacity to accommodate these trips at all of the specified destinations.

In summary, the user must specify the total trips generated at each of the origin nodes, the maximum number of trips that can be accommodated by each of the specified destination nodes and the highway network attributes which include the traffic control tactics. The TRAD model includes a function which expresses travel time on each network link in terms of traffic volume and link capacity. This function drives the underlying trip distribution and trip assignment decision-making process. Thus, the TRAD model satisfies the objectives of evacuees to select destination nodes and travel paths to minimize evacuation travel time. As such, this integrated model is classified as a behavioral model.

At the outset, it may appear that we have an intractable problem:

- If TRAD retains the basic assignment algorithm, it must be provided a Trip Table as input.
- On the other hand, if the distribution model is embedded within the assignment model, rather than preceding it, a Trip Table is not available as input.

The resolution of this problem is as follows:

1. We construct an "augmentation" network that allows the user to specify only the volume for each origin node. The allocation of trips from the origin node to each candidate destination node, is not specified and will be determined internally by the model.
2. We construct pseudo-links which enforce the specified values of attraction,  $A_j$ , for all destination nodes,  $j$ , by suitably calibrating the relationship of the travel time vs. volume and capacity.

This augmented network is comprised of three sub-networks:

1. The highway sub-network, which consists of "Class I" Links and Nodes.
2. A sub-network of "Class II" Pseudo-Links which acts as an interface between the highway sub-network and the network augmentation.
3. The sub-network of "Class III" Pseudo-Links and Nodes which comprises the network augmentation described above.

The need for these Class II links will become clear later. The classifications are described below:

### Class I Links and Nodes

These links and nodes represent the physical highway network: sections of highway and intersections. Trips generated at each Origin [Centroid] Node are assigned to a specified Class I link via a "connector" link. These connector links are transparent to the user and offer no impedance to the traveler; they represent the aggregation of local streets which service the centroidal generated trips and feed them onto the highway network. The real-world destination nodes are part of this network. The immediate approaches to these destination nodes are Class I links.

### Class II Links

These pseudo-links are constructed so as to connect each specified destination node with its Class III Pseudo-Node (P-N) counterpart on a one-to-one basis. The capacities of these Class II links are set equal to the capacities at their respective destination nodes.

### Class III Links and Nodes

Class III links and nodes form the augmentation to the basic network. These Pseudo-Links provide paths from the Class II links servicing traffic traveling from the specified [real] destination nodes, to the Super-Nodes which represent the user-specified set of destination nodes associated with each origin node.

Each Class of links provides a different function:

- Class I links represent the physical highway network. As such, each link has a finite capacity, a finite length and an estimated travel time for free-flowing vehicles. The nodes generally represent intersections, interchanges and, possibly, changes in link geometry. The topology of the Class I network represents that of the physical highway system.
- The Class II links represent the interface between the real highway sub-network and the augmentation sub-network. These pseudo-links are needed to represent the specified "attractions" of each destination node, i.e., the

maximum number of vehicles that can be accommodated by each destination node. Instead of explicitly assigning a capacity limitation to the destination nodes, we assign this capacity limitation of the Class II Pseudo-Links. This approach is much more suitable, computationally.

- The topology of the network augmentation (i.e., Class III Links and Nodes) is designed so that all traffic from an origin node can only travel to the single “Super-Node” by flowing through its set of real destination nodes, thence along the links of the augmented network.

The Class II Pseudo-Links and the network augmentation of Class III Pseudo-Nodes and Links represent logical constructs of fictitious links created internally by the model, that allows the user to specify the identity of all destination nodes in each origin-based set, without specifying the distribution of traffic volumes from the origin to each destination node in that set.

### Calculation of Capacities and Impedances

Each class of links exhibits different properties. Specifically, the relationship between travel impedance (which is expressed in terms of travel time) and both volume and capacity will differ:

- For Class I links, the capacity represents the physical limitation of the highway sections. Travel impedance is functionally expressed by relating travel time with respect to the traffic volume-link capacity relationship.
- For Class II links, link capacity represents the maximum number of vehicles that can be accommodated at the [real] destination nodes that form the upstream nodes of each Class II link. Since Class II links are Pseudo-Links, there should be virtually no difference in impedance to traffic along Class II links when the assigned traffic volume on these links is below their respective capacities. That is, the assignment of traffic should not be influenced by differences in travel impedance on those Class II links where the assigned volumes do not exceed their respective capacities.
- For Class III links, both capacity and impedance have no meaning. Since the Class II links limit the number of vehicles entering the Class III sub-network at all entry points (i.e., at the Class II Pseudo-Nodes) and since all these links are Pseudo-Links, it follows that the Class III network is, by definition, an uncapacitated network.

## Specification of the Objective Function

It is computationally convenient to be able to specify a single impedance (or "cost") function relating the travel time on a link, to its capacity and assigned traffic volume, for all classes of links. To achieve this, we will adopt the following form based on the original "BPR Formula<sup>2</sup>":

$$T = T_o \{ \alpha [1 + a_1 (\frac{V}{C})^{b_1}] + \beta [1 + a_2 (\frac{V}{C})^{b_2}] \} + I$$

Where, as for the present traffic assignment model in TRAD,

T	=	Link travel time, sec.
T <sub>o</sub>	=	Unimpeded link travel time, sec.
V	=	Traffic volume on the link, veh/hr
C	=	Link capacity, veh/hr
a <sub>i</sub> , b <sub>i</sub>	=	Calibration parameters
α, β	=	Coefficients defined below
I	=	Impedance term, expressed in seconds, which could represent turning penalties or any other factor which is justified in the user's opinion

The assignment of coefficients varies according to the Class in which a link belongs:

Class	α	β	T <sub>o</sub>
I	1	0	L/U <sub>f</sub>
II	0	1	W
III	0	0	1

Here, L is a highway link length and U<sub>f</sub> is the free-flow speed of traffic on a highway link. The values of a<sub>1</sub> and b<sub>1</sub>, which are applicable only for Class I links, are based on experimental data:

$$a_1 = 0.8 \qquad b_1 = 5.0$$

The values of a<sub>2</sub> and b<sub>2</sub>, which are applicable for each Class II link, are based upon the absolute requirement that the upstream destination node can service no more traffic than the user-specified value of the maximum "attraction". In addition, these parameters must be chosen so that these Pseudo-Links all offer the same impedance to traffic when their assigned volumes are less than their respective specified maximum attractions.

The weighting factor, W, is computed internally by the software.

<sup>2</sup> Bureau of Public Roads (1964). Traffic Assignment Manual. U.S. Dept. of Commerce, Urban Planning Division, Washington D.C.

Of course, it is still possible for the assignment algorithm within TRAD to distribute more traffic to a destination node than that node can accommodate. For emergency planning purposes, this is a desirable model feature. Such a result will be flagged by the model to alert the user to the fact that some factor is strongly motivating travelers to move to that destination node, despite its capacity limitations. This factor can take many forms: inadequate highway capacity to other destinations, improper specification of candidate destinations for some of the origins, or some other design inadequacy. The planner can respond by modifying the control tactics, changing the origin-destination distribution pattern, providing more capacity at the overloaded destinations, etc.

APPENDIX C

Traffic Simulation Model: PC-DYNEV



## APPENDIX C: TRAFFIC SIMULATION MODEL: PC-DYNEV

A model, named PC-DYNEV, is an adaptation of the TRAFLO Level II simulation model, developed by KLD for the Federal Highway Administration (FHWA). Extensions in scope were introduced to expand the model's domain of application to include all types of highway facilities, to represent the evacuation traffic environment and to increase its computational efficiency. This model produces the extensive set of output Measures of Effectiveness (MOE) shown in Table C-1.

The traffic stream is described internally in the form of statistical flow profiles. These profiles, expressed internally as statistical histograms, describe the platoon structure of the traffic stream on each network link. The simulation logic identifies five types of histograms:

- The ENTRY histogram which describes the platoon flow at the upstream end of the subject link. This histogram is simply an aggregation of the appropriate OUTPUT turn-movement-specific histograms of all feeder links.
- The INPUT histograms which describe the platoon flow pattern arriving at the stop line. These are obtained by first disaggregating the ENTRY histogram into turn-movement-specific component ENTRY histograms. Each such component is modified to account for the platoon dispersion which results as traffic traverses the link. The resulting INPUT histograms reflect the specified turn percentages for the subject link.
- The SERVICE histogram which describes the service rates for each turn movement. These service rates reflect the type of control device servicing traffic on this approach; if it is a signal, then this histogram reflects the specified movement-specific signal phasing. A separate model estimates service rates for each turn movement, given that the control is GO.

These data are provided for each network link and are also aggregated over the entire network.

- The QUEUE histograms that describe the time-varying ebb and growth of the queue formation at the stop line. These histograms are derived from the interaction of the respective IN histograms with the SERVICE histograms.
- The OUT histograms that describe the pattern of traffic discharging from the subject link. Each of the IN histograms is transformed into an OUT histogram by the control applied to the subject link. Each of these OUT histograms is added into the (aggregate) ENTRY histogram of its receiving link. This approach provides the model with the ability to identify the characteristics of each turn-movement-specific component of the traffic stream. Each component is serviced at a different saturation flow rate as is the case in the real world. The logic recognizes when one component of the traffic flow encounters saturation conditions even if the others do not.

Algorithms provide estimates of delay and stops, reflecting the interaction of the IN histograms with the SERVICE histograms. The logic also provides for properly treating spillback conditions reflecting queues extending from its host link, into its upstream feeder links.

A valuable feature is the ability to internally generate functions that relate mean speed to density on each link, given user-specified estimates of free-flow speed and saturation service rates for each link. Such relationships are essential in order to simulate traffic operations on freeways and rural roads, where signal control does not exist or where its effect is not the dominant factor in impeding traffic flow.

All traffic simulation models are data-intensive. Table C-2 outlines the input data elements. This input describes:

- Topology of the roadway system
- Geometrics of each roadway component
- Channelization of traffic on each roadway component
- Motorist behavior that, in aggregate, determines the operational performance of vehicles in the system
- Specification of the traffic control devices and their operational characteristics
- Traffic volumes entering and leaving the roadway system
- Traffic composition.

To provide an efficient framework for defining these specifications, the physical environment is represented as a network. The unidirectional links of the network generally represent roadway components: either urban streets or freeway segments. The nodes of the network generally represent urban intersections or points along the freeway where a geometric property changes (e.g. a lane drop, change in grade or ramp).

Figure C-1 is an example of a small network representation. The freeway is defined by the sequence of links, (20,21), (21,22), and (22,23). Links (8001, 19) and (3, 8011) are Entry and Exit links, respectively. An arterial extends from node 3 to node 19 and is partially subsumed within a grid network. Note that links (21,22) and (17,19) are grade-separated.

<b>Table C-1. Measures of Effectiveness Output by PC-DYNEV</b>	
<b>Measure</b>	<b>Units</b>
Travel	Vehicle-Miles and Vehicle-Trips
Moving Time	Vehicle-Minutes
Delay Time	Vehicle-Minutes
Total Travel Time	Vehicle-Minutes
Efficiency: Moving Time/Total Travel Time	Percent
Mean Travel Time per Vehicle	Seconds
Mean Delay per Vehicle	Seconds
Mean Delay per Vehicle-Mile	Seconds/Mile
Mean Speed	Miles/Hour
Mean Occupancy	Vehicles
Mean Saturation	Percent
Vehicle Stops	Percent

**Table C-2. Input Requirements for the PC-DYNEV Model**

GEOMETRICS

- Links defined by upstream downstream node numbers
- Link lengths
- Number of lanes (up to 6)
- Turn pockets
- Grade
- Network topology defined in terms of target nodes for each receiving link

TRAFFIC VOLUMES

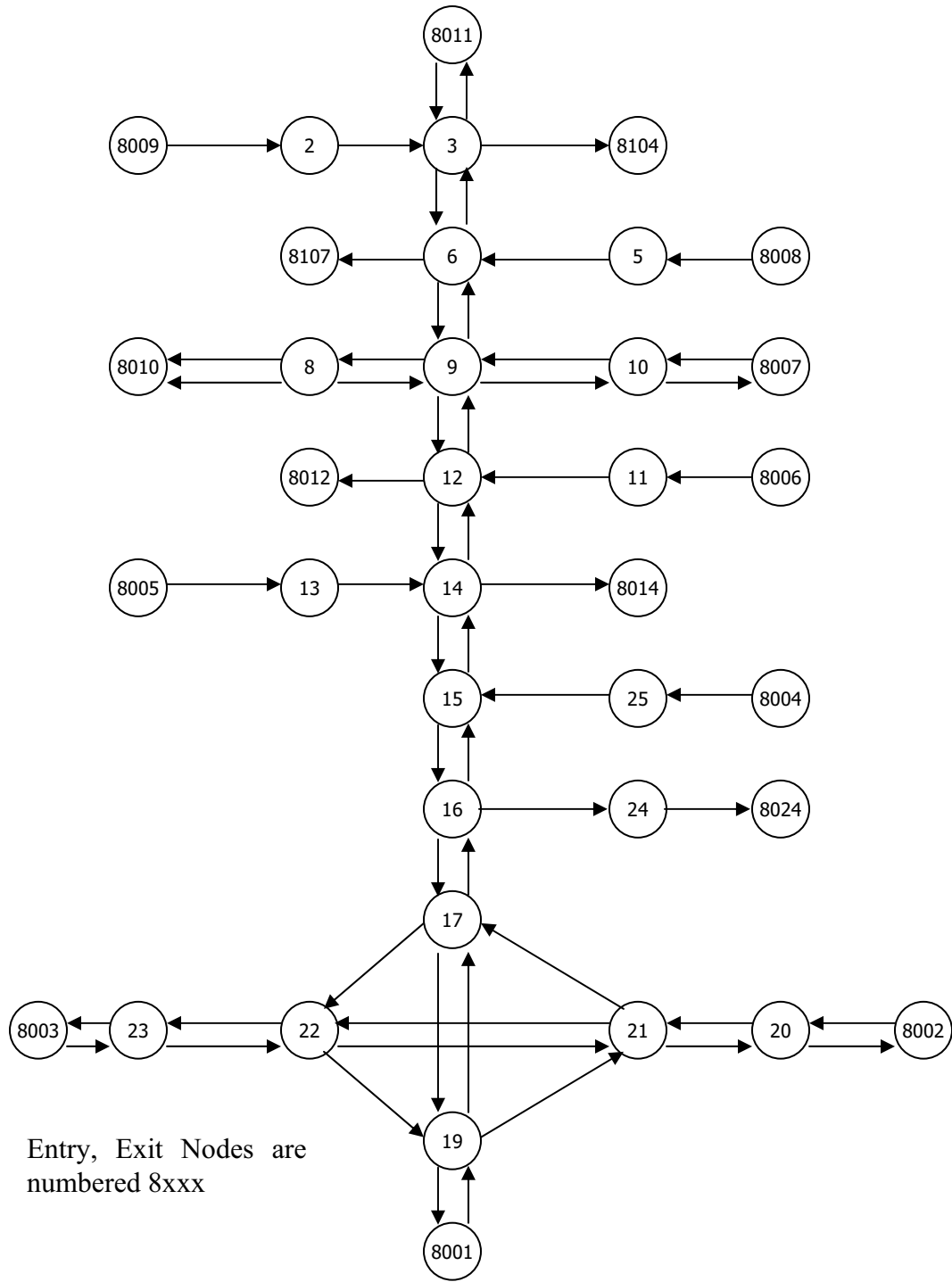
- On all entry links and sink/source nodes stratified by vehicle type: auto, car pool, bus, truck
- Link-specific turn movements

TRAFFIC CONTROL SPECIFICATIONS

- Traffic signals: link-specific, turn movement specific
- Signal control treated as fixed time
- Stop and Yield signs
- Right-turn-on-red (RTOR)
- Route diversion specifications
- Turn restrictions
- Lane control (e.g. lane closure, movement-specific)

DRIVER'S AND OPERATIONAL CHARACTERISTICS

- Drivers (vehicle-specific) response mechanisms: free-flow speed, aggressiveness, discharge headway
- Link-specific mean speed for free-flowing (unimpeded) traffic
- Vehicle-type operational characteristics: acceleration, deceleration
- Such factors as bus route designation, bus station location, dwell time, headway, etc.



**Figure C-1: Representative Analysis Network**

## APPENDIX D

Detailed Description of Study Procedure

## APPENDIX D: DETAILED DESCRIPTION OF STUDY PROCEDURE

This appendix describes the activities that were performed to compute accurate Evacuation Time Estimates (ETE). The individual steps of this effort are represented as a flow diagram in Figure D-1. Each numbered step in the description that follows corresponds to the numbered element in this flow diagram.

### Step 1.

The first activity is to obtain data defining the spatial distribution and demographic characteristics of the population within the Emergency Planning Zone (EPZ). These data were obtained from U.S. Census files and from the results of a telephone survey conducted within the EPZ. Employee and Transient populations were estimated from data provided by STP and Matagorda County.

### Step 2.

The next activity is to examine large-scale maps of the EPZ in both hard-copy form and using Geographical Information System (GIS) software. These maps were used to identify the analysis highway network and the access roads from each residential development to the adjoining elements of this network. This information is used to plan a field survey of the highway system and later, to assign generated evacuation trips to the correct links of the network.

### Step 3.

The next step is to conduct a physical survey of the roadway system. The purpose of this survey is to determine the geometric properties of the highway elements, the channelization of lanes on each section of roadway, whether there are any turn restrictions or special treatment of traffic at intersections, the type and functioning of traffic control devices and to make the necessary observations needed to estimate realistic values of roadway capacity.

### Step 4.

With this information, develop the evacuation network representation of the physical roadway system.

### Step 5.

With the network drawn, proceed to estimate the capacities of each link and to locate the origin centroids where trips would be generated during the evacuation process.

### Step 6.

With this information at hand, the data were entered into the computer to create the input stream for the TRaffic Assignment and Distribution (TRAD) model. This model was designed to be compatible with the PC-DYNEV traffic simulation model used later in the project; the input stream required for one model is entirely compatible with the input stream required by the other. Using a software system developed by KLD named UNITES, the data entry activity is performed interactively directly on the computer.

### Step 7.

The TRAD model contains software that performs diagnostic testing of the input stream. These assist the user in identifying and correcting errors in the input stream.

### Step 8.

After creating the input stream, execute the TRAD model to compute evacuating traffic routing patterns consistent with the guidelines of NUREG-0654, Appendix 4. The TRAD model also provides estimates of traffic loading on each highway link as well as rough estimates of operational performance.

### Step 9.

Critically examine the statistics produced by the TRAD model. This is a labor-intensive activity, requiring the direct participation of skilled engineers who possess the necessary practical experience to interpret the results and to determine the causes of any problems reflected in the results.

Essentially, the approach is to identify those "hot spots" in the network that represent locations where congested conditions are pronounced and to identify the cause of this congestion. This cause can take many forms, either as excess demand due to improper routing, as a shortfall of capacity, or as a quantitative error in the way the physical system was represented in the input stream. This examination leads to one of two conclusions:

- The results are as satisfactory as could be expected at this stage of the analysis process; or
- The input stream must be modified accordingly.

This decision requires, of course, the application of the user's judgment based upon the results obtained in previous applications of the TRAD model and a comparison of the results of this last case with the previous ones. If the results are satisfactory in the opinion of the user, then the process continues with Step 12. Otherwise, proceed to Step 10.

### Step 10.

There are many "treatments" available to the user in resolving such problems. These treatments range from decisions to reroute the traffic by imposing turn restrictions where they can produce significant improvements in capacity, changing the control treatment at critical intersections so as to provide improved service for one or more movements, or in prescribing specific treatments for channelizing the flow so as to expedite the movement of traffic along major roadway systems or changing the trip table. Such "treatments" take the form of modifications to the original input stream.

### Step 11.

As noted above, the changes to the input stream must be implemented to reflect the modifications undertaken in Step 10. At the completion of this activity, the process returns to Step 8 where the TRAD model is again executed.



### Step 12.

The output of the TRAD model includes the computed turn movements for each link. These data are required – and – accessed by the PC-DYNEV simulation model. This step completes the specification of the PC-DYNEV input stream.

### Step 13.

After the PC-DYNEV input stream has been debugged, the simulation model is executed to provide detailed estimates, expressed as statistical Measures of Effectiveness (MOE), which describe the detailed performance of traffic operations on each link of the network.

### Step 14.

In this step, the detailed output of the simulation model is examined to identify whether problems exist on the network. The results of the simulation model are extremely detailed and far more accurately describe traffic operations than those provided by the TRAD model. Thus, it is possible to identify the cause of any problems by carefully studying the output.

Again, one can implement corrective treatments designed to expedite the flow of traffic on the network in the event that the results are considered to be less efficient than is possible to achieve. If input changes are needed, the analysis process proceeds to Step 15. On the other hand, if the results are satisfactory, then one can decide whether to return to Step 8 to again execute the TRAD model and repeat the whole process, or to accept the simulation results. If there were no changes indicated by the activities of Step 14, because the results were satisfactory, we can then proceed to document them in Step 17. Otherwise, return to Step 8 to determine the effects of the changes implemented in Step 14 on the optimal routing patterns over the network. This determination can be ascertained by executing the TRAD model.

### Step 15.

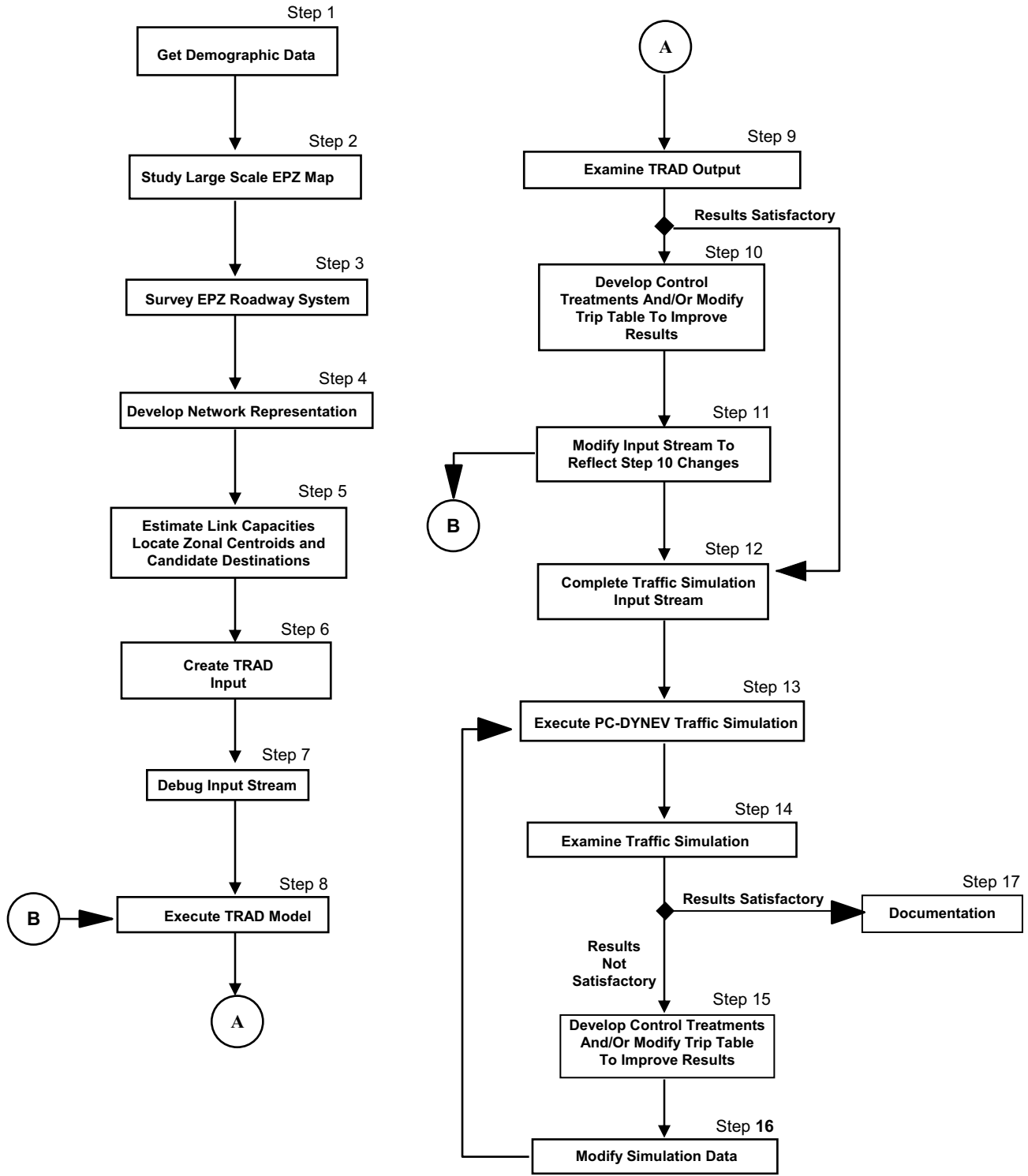
This activity implements the changes in control treatments or in the assignment of destinations associated with one or more origins in order to improve the representation of traffic flow over the network. These treatments can also include the consideration of adding roadway segments to the existing analysis network to improve the representation of the physical system.

### Step 16.

Once the treatments have been identified, it is necessary to modify the simulation model input stream accordingly. At the completion of this effort, the procedure returns to Step 13 to execute the simulation model again.

### Step 17.

The simulation results are analyzed, tabulated and graphed. The results are then documented, as required.



**Figure D-1. Flow Diagram of Activities**

APPENDIX E

Special Facility Data

## APPENDIX E: SPECIAL FACILITY DATA

The following tables list population information, as of March 2007, for special facilities that are located within the South Texas Project (STP) EPZ. Special facilities are defined as schools, major employers, lodging facilities and recreational areas. No day care centers, medical care facilities, or correctional institutions were identified within the EPZ. Transient population data is included in the tables for recreational areas and lodging facilities. The location of the facility is defined by its straight-line distance (miles) and direction (magnetic bearing) from the STP.

**Table E-1. Schools within the STP EPZ (As of March 2007)**

ZONE	Distance (miles)	Direction	School Name	Street Address	Municipality	Phone	Enrollment	Staff
<b>MATAGORDA COUNTY</b>								
7	8.5	SE	Matagorda Elementary School	717 Wightman St	Matagorda	(979) 863-7693	70	20
10	8.2	NW	Tidehaven Middle School	2469 FM 459	El Maton	(361) 588-6600	178	25
10	9.1	NW	Tidehaven High School	144 FM 1095	El Maton	(361) 588-6810	271	42
<b>Total</b>							<b>519</b>	<b>87</b>

**Table E-2. Major Employers within the STP EPZ (As of March 2007)**

ZONE	Distance (miles)	Direction	Facility Name	Street Address	Municipality	Phone	Employees
<b>MATAGORDA COUNTY</b>							
1	0.0		STP	FM 521	Bay City	(361) 972-3611	1,003
2	4.8	NNE	Celanese Chemicals	P.O. Box 509, 2001 FM 3057	Bay City	(979) 241-4300	27
3	6.7	E	Lyondell Chemicals	U.S. 60, 13 miles south of Bay City	Bay City	(979) 244-7137	163
<b>Total</b>							<b>1,193</b>

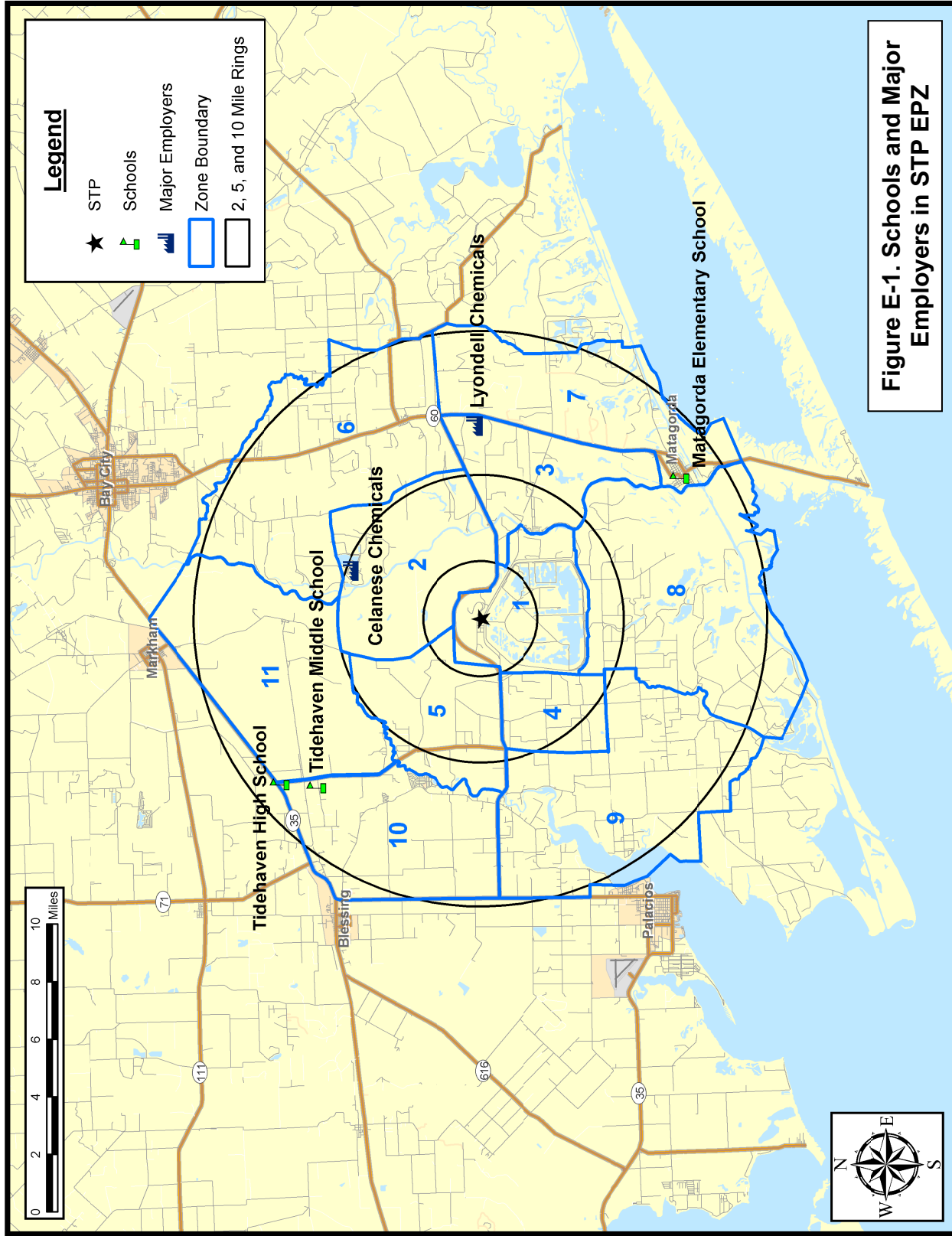
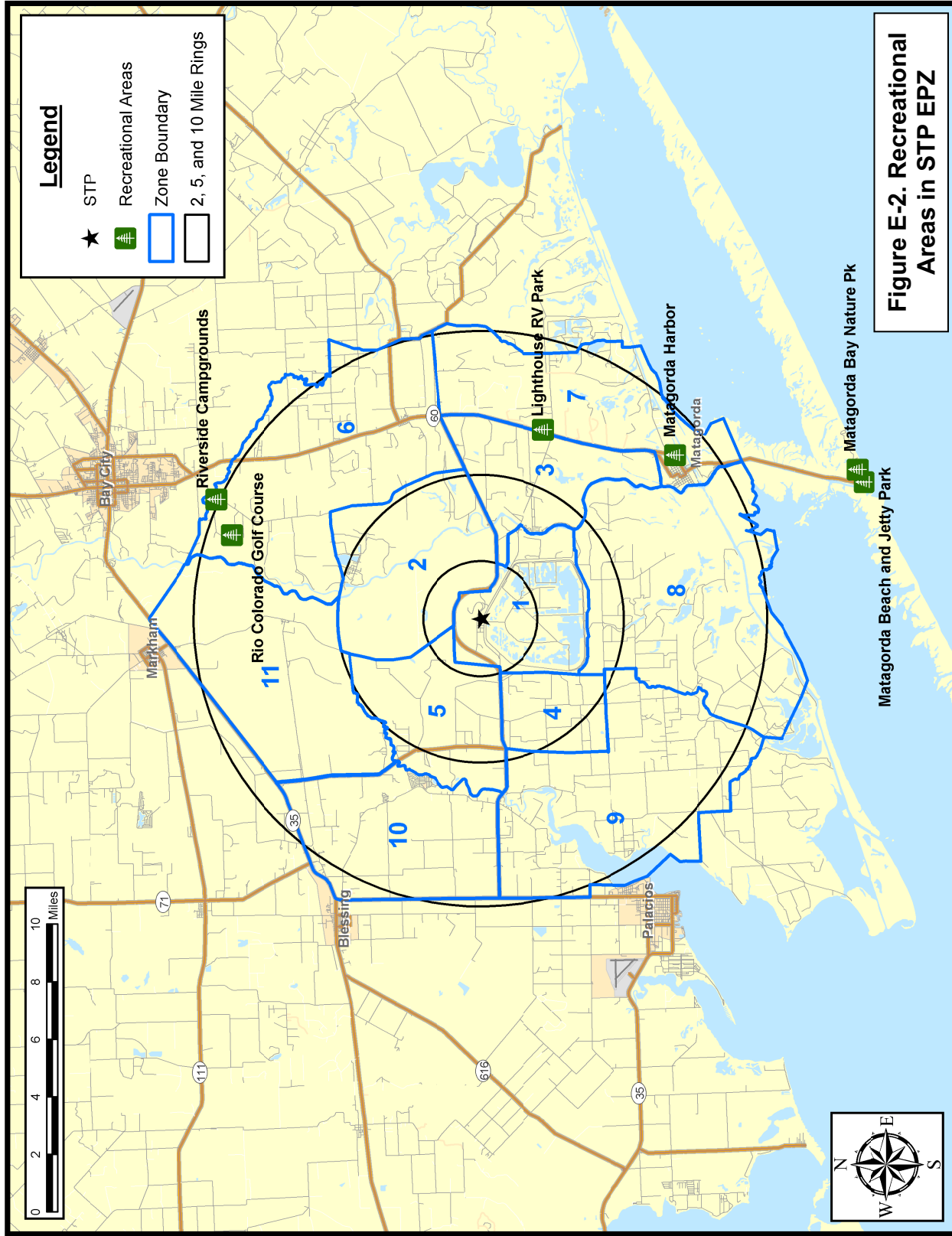


Table E-3. Recreational Areas within the STP EPZ (As of March 2007)								
ZONE	Distance (miles)	Direction	Facility Name	Street Address	Municipality	Phone	Total Vehicles	
<b>MATAGORDA COUNTY</b>								
3	6.9	ESE	Lighthouse RV Park	18411 Hwy 60	Bay City	(979) 863-7773	50	
6	9.2	NNE	Rio Colorado Golf Course	FM-2668 Riverside Pk	Bay City	(979) 244-2955	120	
6	10.1	NNE	Riverside Campgrounds	7330 FM 2668	Bay City	(979) 245-0340	180	
7	8.9	NE	Matagorda Harbor	Hwy 60, Matagorda	Matagorda	(979) 863-2103	300	
*	14.3	SSE	Matagorda Bay Nature Park	End of FM 2031	Matagorda	(979) 557-6261	130	
*	14.3	SSE	Matagorda Beach and Jetty Park	End of FM 2031	Matagorda	(979) 863-7861	1,000	
<b>Total</b>							<b>1,780</b>	<b>865</b>

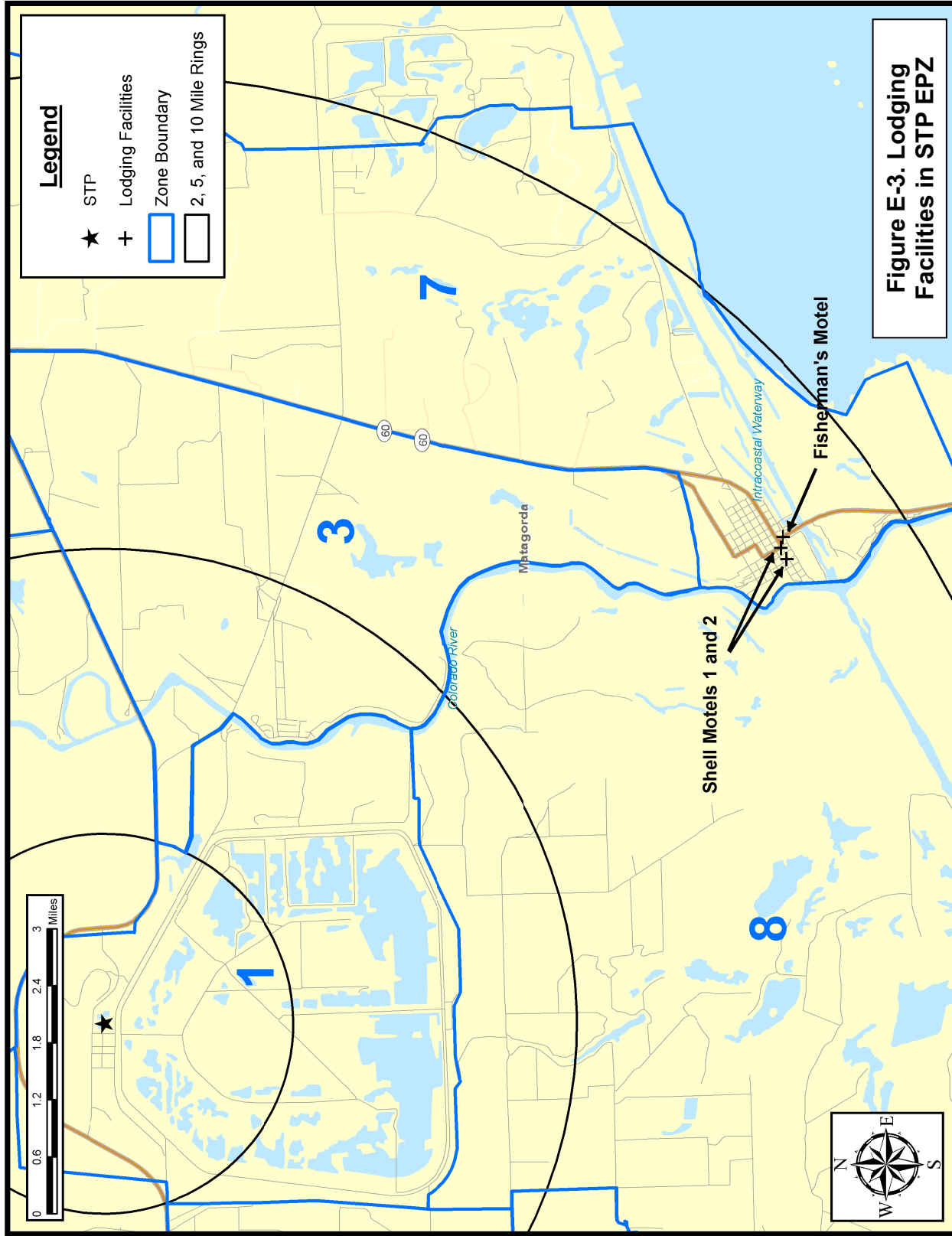
\*The Matagorda Beach area has only one access road - FM 2031, which cuts through the STP EPZ. It is prudent to evacuate both the resident and transient population on the beach in the event of an emergency, since an escalation of the event or a change in wind direction could expose those evacuees on FM 2031 to the plume. Thus, it is assumed that in every scenario and for every region these people will be evacuated, and their vehicles will be included in the network traffic.



**Figure E-2. Recreational Areas in STP EPZ**



Table E-4. Lodging Facilities within the STP EPZ (As of March 2007)								
ZONE	Distance (miles)	Direction	Facility Name	Street Address	Municipality	Phone	Persons	Vehicles
<b>MATAGORDA COUNTY</b>								
7	8.7	SE	Fisherman's Motel	40 Fisher St	Matagorda	(979) 863-0000	56	14
7	8.8	SE	Shell Motel 1	778 Market St	Matagorda	(979) 863-2520	36	24
7	8.8	SE	Shell Motel 2	1200 Fisher St	Matagorda	(979) 863-2520	18	12
<b>Total</b>							<b>110</b>	<b>50</b>



**Figure E-3. Lodging Facilities in STP EPZ**

APPENDIX F

Telephone Survey

## APPENDIX F: TELEPHONE SURVEY

### **1. INTRODUCTION**

The development of Evacuation Time Estimates (ETE) for the Emergency Planning Zone (EPZ) of the South Texas Project requires the identification of travel patterns, car ownership and household size of the population within the EPZ. Demographic information is obtained from Census data. The use of this data has several limitations when applied to emergency planning. First, the census data do not encompass the range of information needed to identify the time required for preliminary activities that must be undertaken prior to evacuating the area. Secondly, the census data do not contain attitudinal responses needed from the population of the EPZ and consequently may not accurately represent the anticipated behavioral characteristics of the evacuating populace.

These concerns are addressed by a telephone survey. The survey is designed to elicit information from the public concerning family demographics and estimates of response times to well defined events. The design of the survey includes a limited number of questions of the form "What would you do if ...?" and other questions regarding activities with which the respondent is familiar ("How long does it take you to ...?")

## 2. SURVEY INSTRUMENT AND SAMPLING PLAN

Attachment A presents the final survey instrument. A draft of the instrument was submitted for comment. Comments were received and the survey instrument was modified accordingly.

Following the completion of the instrument, a sampling plan was developed. A sample size of approximately 500 completed survey forms yields results with an acceptable sampling error. The sample must be drawn from the EPZ population. Consequently, a list of EPZ zip codes was developed. This list is shown in Table F-1. Along with each zip code, an estimate of the population in each area was determined. The proportional number of the desired completed survey interviews for each area was identified, as shown in Table F-1. The completed survey adhered to the sampling plan.

<b>Table F-1. STP Telephone Survey Sampling Plan</b>						
<b>Zip Code</b>	<b>Zip Population (2000)</b>	<b>EPZ Population in Zip Code (2000)</b>	<b>Zip Code Households</b>	<b>Households in EPZ</b>	<b>Required Sample</b>	<b>Over Sampling in Zip Code due to Sparse Population</b>
77414	23,596	844	9,042	282	106	338
77419	1,440	844	552	282	106	21
77440	498	463	191	190	72	8
77456	1,999	285	766	108	41	29
77457	913	695	350	335	126	14
77465	6,181	361	2,369	141	53	90
	34,627	3,492	13,270	1,338	500	500
<b>Average Household Size</b>				<b>2.61</b>		
<b>Total Sample Required</b>				<b>500</b>		

Due to the sparse population of the zip codes within the EPZ, the area which was sampled was expanded (within the zip codes identified) so that an appropriate sample could be gathered. The over-sampling was computed in proportion to the entire zip code population. The approach is justified on the basis that the area outside of the EPZ has similar land-use and housing characteristics as does the EPZ. We were careful to avoid sampling multi-family dwellings in the over-sample area since the EPZ does not contain these dwellings. The completed survey adhered to the over-sampling plan.

### 3. SURVEY RESULTS

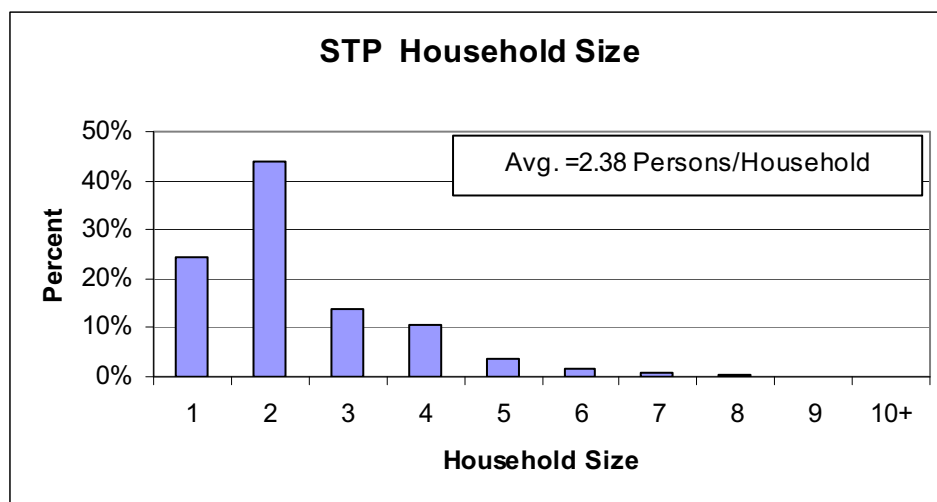
The results of the survey fall into two categories. First, the household demographics of the area can be identified. Demographic information includes such factors as household size, automobile ownership, and automobile availability. The distributions of the time to perform certain pre-evacuation activities are the second category of survey results. These data are processed to develop the trip generation distributions used in the evacuation modeling effort.

A review of the survey instrument reveals that several questions have a “don’t know” (DK) entry for a response. It is accepted practice in conducting surveys of this type to accept the answers of a respondent who offers a DK response for a few questions or who refuses to answer a few questions. To address the issue of occasional DK/refused responses from a large sample, the practice is to assume that the distribution of these responses is the same as the underlying distribution of the positive responses. In effect, the DK/refused responses are ignored and the distributions are based upon the positive data that is acquired.

#### Household Demographic Results

##### Household Size

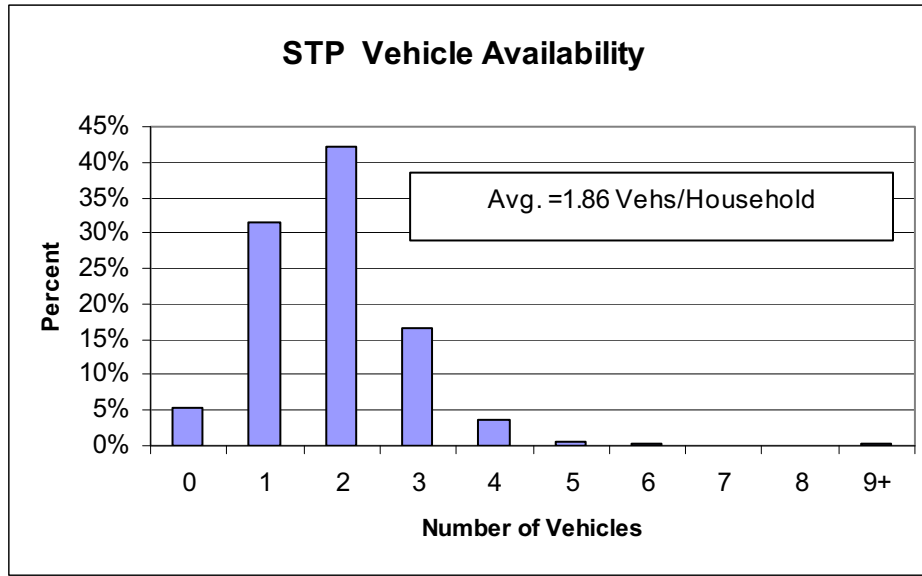
Figure F-1 presents the distribution of household size within the EPZ. The average household contains 2.38 people. The estimated household size (2.61 persons) used to determine the survey sample (Table F-1) was drawn from Census data. The average household size obtained from survey results is within 10% of the census value and is an indication of the reliability of the survey.



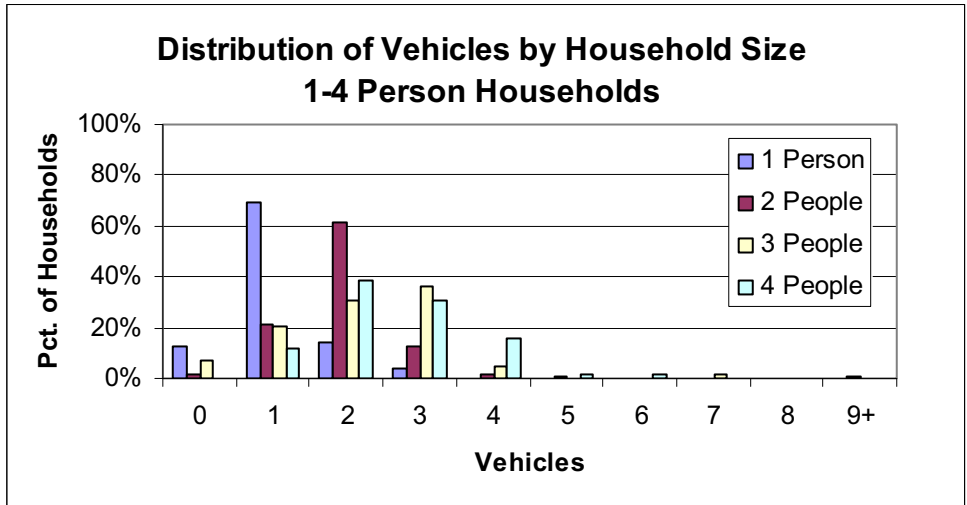
**Figure F-1. Household Size in the EPZ**

## Automobile Ownership

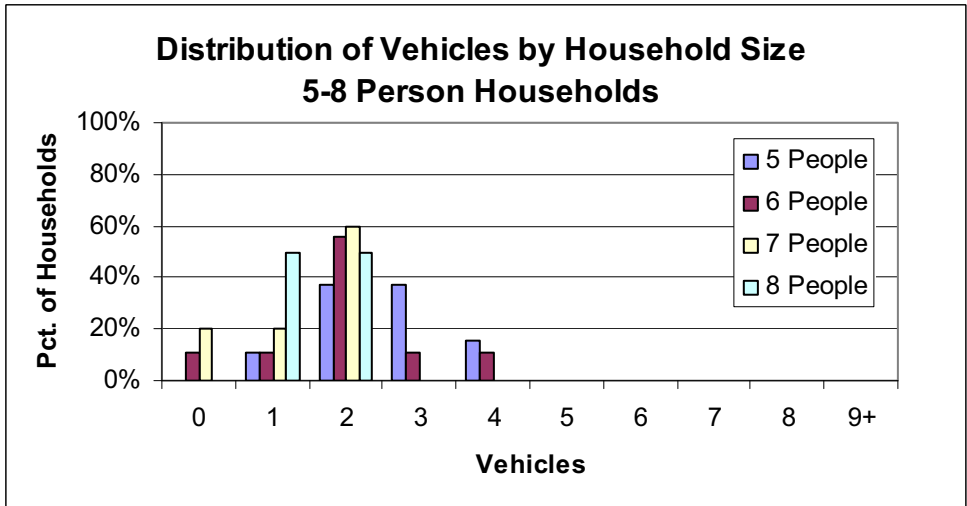
The average number of automobiles per household in the EPZ is 1.86. The distribution of automobile ownership is presented in Figure F-2. Figures F-3 and F-4 present the automobile availability by household size. It should be noted that approximately 5.3 percent of households do not have access to an automobile; 74 percent of households have access to one or two automobiles. Note that the majority of households without access to a car are single person households.



**Figure F-2. Household Vehicle Availability**



**Figure F-3. Vehicle Availability – 1 to 4 Person Households**

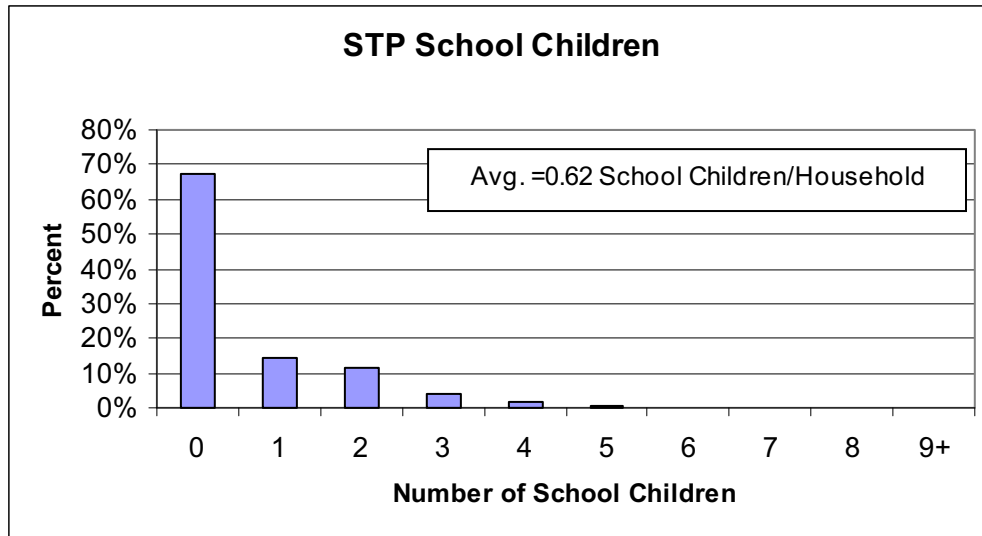


**Figure F-4. Vehicle Availability – 5 to 8 Person Households**



## School Children

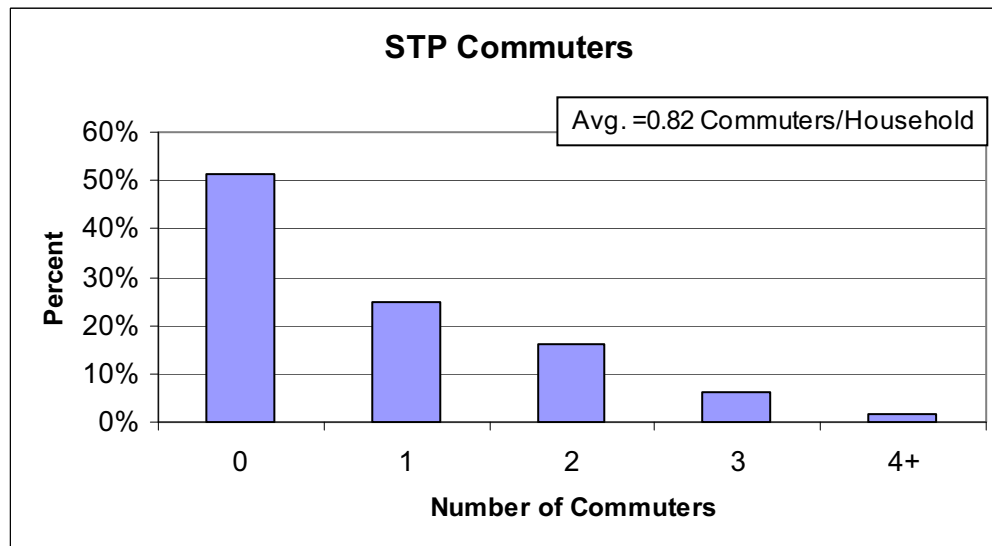
The average number of school children per household identified by the survey is 0.62. Figure F-5 presents the distribution of school children.



**Figure F-5. School Children in Households**

## Commuters

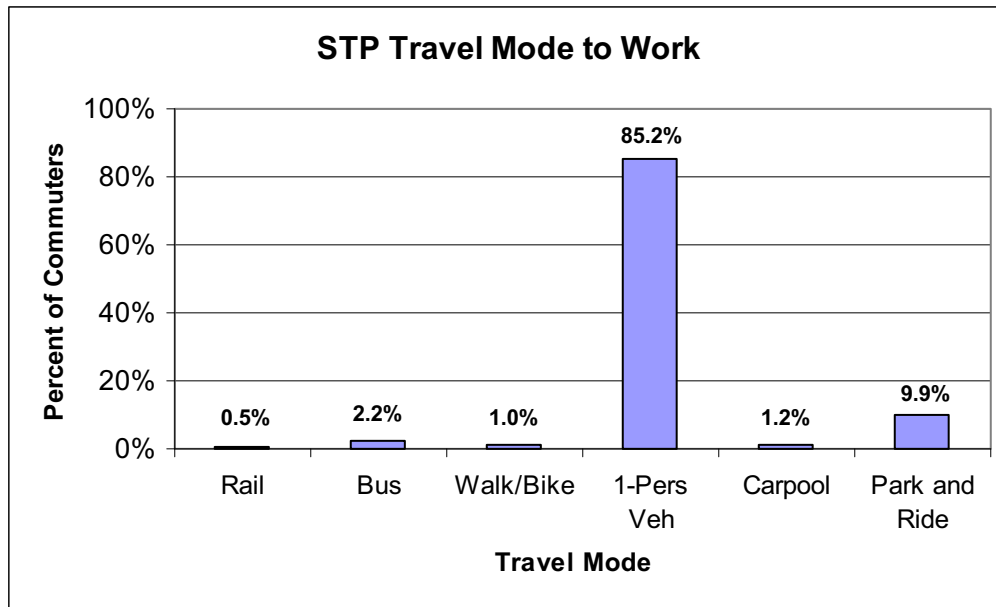
Figure F-6 presents the distribution of the number of commuters in each household. The data shows an average of 0.82 commuters in each household in the EPZ.



**Figure F-6. Commuters in Households in the EPZ**

## Commuter Travel Modes

Figure F-7 presents the mode of travel that commuters use on a daily basis. The vast majority of commuters use their private automobiles to travel to work or school.



**Figure F-7. Modes of Travel in the EPZ**

## **Evacuation Response**

Several questions were asked which are used to gauge the population's response to an emergency. The first of these asked "How many of the vehicles that are usually available to the household would your family use during an evacuation?" The response is shown in Figure F-8. On average, 1.43 vehicles per household would be used for evacuation purposes.

The second evacuation response question asked was "When the commuters are away from home, is there a vehicle at home that is available for evacuation during any emergency?" Of the survey participants who responded, 65 percent said that there was another vehicle available to evacuate, while 35 percent answered that there would be no vehicle available for evacuation.

The third evacuation response question was "Would your family await the return of other family members prior to evacuating the area?" Of the survey participants who responded, 70 percent said they would await the return of other family members before evacuating and 30 percent indicated that they would not await the return of other family members.

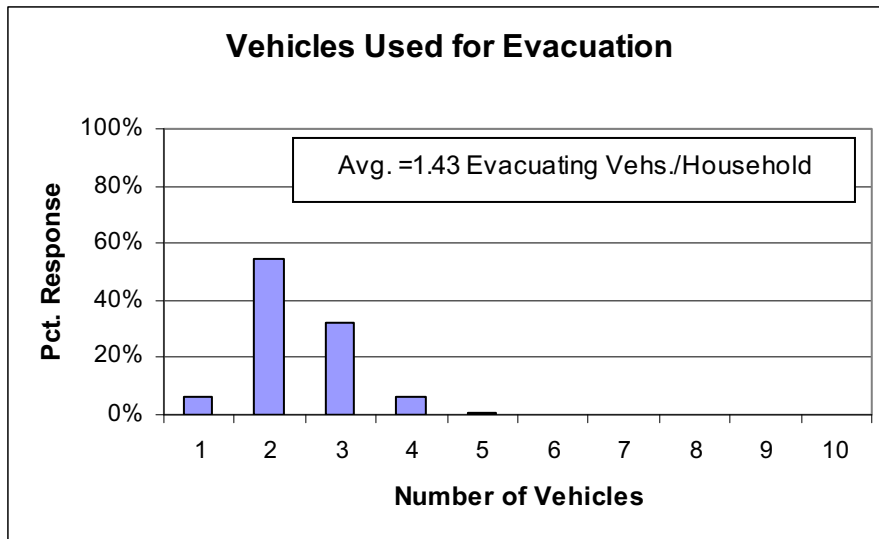


Figure F-8. Number of Vehicles Used for Evacuation

### Time Distribution Results

The survey asked several questions about the amount of time it takes to perform certain pre-evacuation activities. These activities involve actions taken by residents during the course of their day-to-day lives. Thus, the answers fall within the realm of the responder’s experience.

***How long does it take the commuter to complete preparation for leaving work?*** Figure F-9 presents the cumulative distribution. 57 percent can leave within 15 minutes; 90 percent can leave within one hour. Only 2 percent of commuters surveyed said they would need more than two hours to prepare to leave work or school.

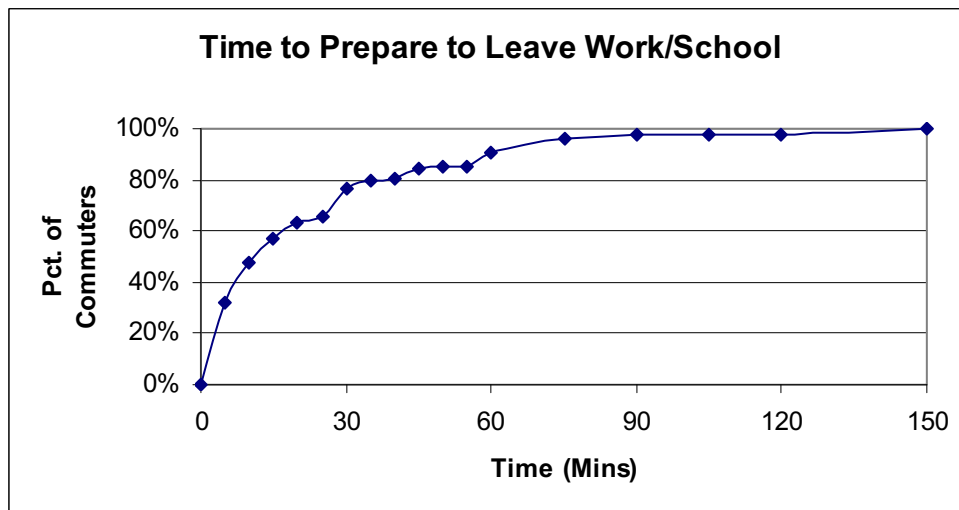
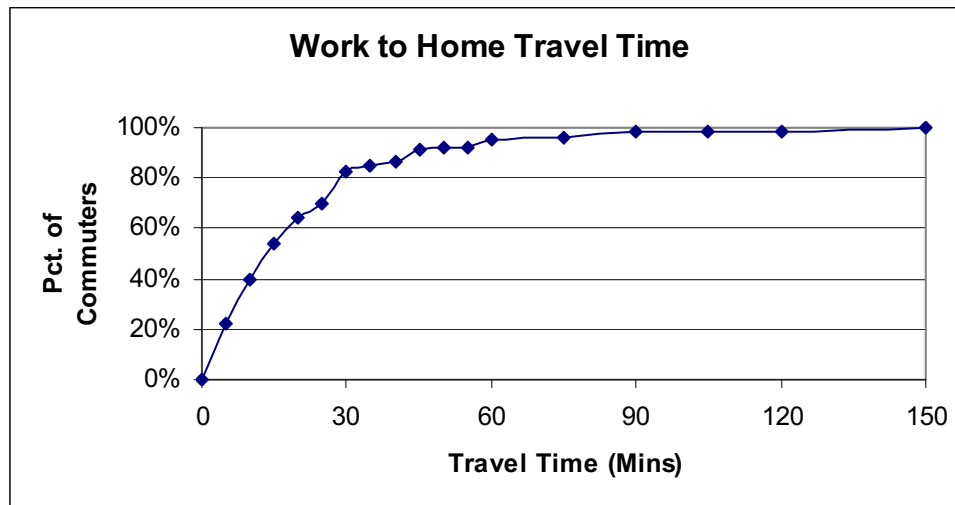


Figure F-9. Time Required to Prepare to Leave Work/School

**How long would it take the commuter to travel home?**

Figure F-10 presents the work to home travel time. Over 90 percent of commuters can arrive home within about 45 minutes of leaving work; nearly all within 75 minutes.



**Figure F-10. Work to Home Travel Time**

**How long would it take the family to pack clothing, secure the house, and load the car?**

Figure F-11 presents the time required to prepare for leaving on an evacuation trip. In many ways this activity mimics a family’s preparation for a short holiday or weekend away from home. Hence, the responses represent the experience of the responder in performing similar activities.

The raw data indicates that about 10% of households responded they would need over 6 hours to prepare their homes for evacuation. Although the survey preamble did attempt to eliminate “weather-related” emergencies (hurricanes) from consideration, the EPZ is in on the Texas gulf coast and hurricane evacuations (especially in light of the [nearby] Hurricane Rita experience in Houston) likely played a role in determining the response to this question.

A recent survey KLD conducted on the Florida Gulf coast specifically stated the emergency being discussed was not weather related. The results of that survey indicated that over 95% of households would complete their home preparation activities by about 4 hours. If we eliminate the outlier data from the STP results, approximately 93% of households would complete their preparations by 4 hours. Since an Advisory to Evacuate predicated on a “fast-breaking” event at STP is fundamentally different than the slow approach of a hurricane, we feel justified in building our trip generation distribution based on the elimination of the outlier data.

Both the raw data and the modified distributions are shown in Figure F-11. Approximately 55 percent of households can be ready to leave home within one hour; between 80 and 90 percent of households can be ready to leave within 3 hours.

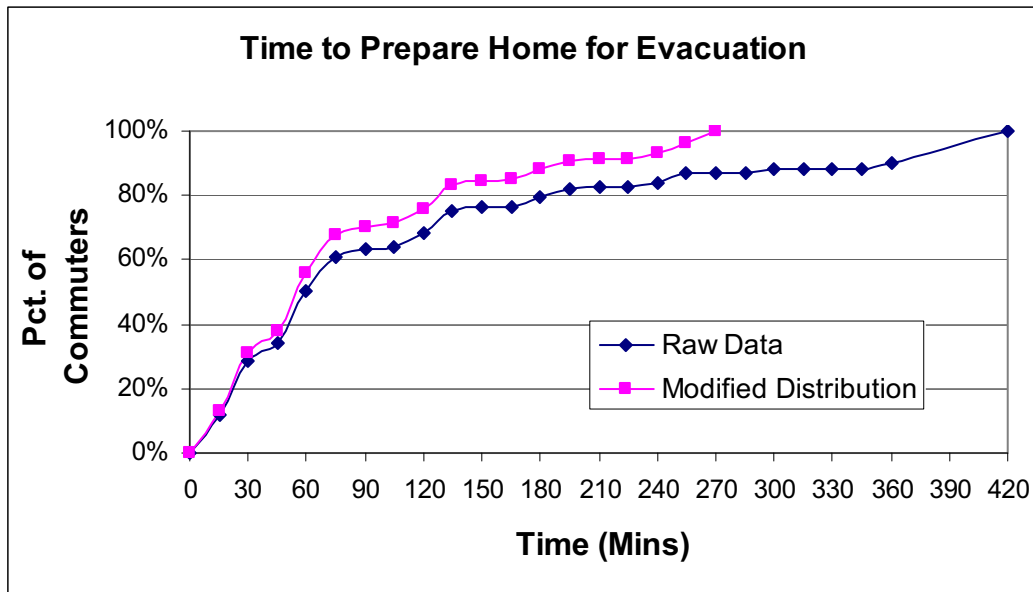


Figure F-11. Time to Prepare Home for Evacuation

#### 4. CONCLUSIONS

The telephone survey provides valuable, relevant data that have been used to quantify “mobilization time” which can influence evacuation time estimates.

ATTACHMENT A

Telephone Survey Instrument

**Survey Instrument**

Hello, my name is \_\_\_\_\_ and I'm working on a survey being made for [insert marketing firm name] designed to identify local travel patterns in your area. The information obtained will be used in a traffic engineering study and in connection with an update of the county's emergency response plans. The survey will be used for emergency plans in response to hazards that

COL.1 Unused  
COL.2 Unused  
COL.3 Unused  
COL.4 Unused  
COL.5 Unused

**are not weather-related.** Your participation in this survey will greatly enhance the county's emergency preparedness program.

Sex COL. 8  
 1 Male  
 2 Female

INTERVIEWER: ASK TO SPEAK TO THE HEAD OF HOUSEHOLD OR THE SPOUSE OF THE HEAD OF HOUSEHOLD.  
(Terminate call if not a single-family residence)

---

DO NOT ASK:

1A. Record area code. To Be Determined

COL. 9-11

1B. Record exchange number. To Be Determined

COL. 12-14

---

2. What is your home Zip Code

Col. 15-19

3. In total, how many cars, or other vehicles are usually available to the household? (DO NOT READ ANSWERS.)

COL.20  
 1 ONE  
 2 TWO  
 3 THREE  
 4 FOUR  
 5 FIVE  
 6 SIX  
 7 SEVEN  
 8 EIGHT  
 9 NINE OR MORE  
 0 ZERO (NONE)  
 X REFUSED

---

4. How many people usually live in this household? (DO NOT READ ANSWERS.)

<u>COL.21</u>	<u>COL.22</u>
1 ONE	0 TEN
2 TWO	1 ELEVEN
3 THREE	2 TWELVE
4 FOUR	3 THIRTEEN
5 FIVE	4 FOURTEEN
6 SIX	5 FIFTEEN
7 SEVEN	6 SIXTEEN
8 EIGHT	7 SEVENTEEN
9 NINE	8 EIGHTEEN
	9 NINETEEN OR MORE
	X REFUSED

5. How many children living in this household go to local public, private, or parochial schools? (DO NOT READ ANSWERS.)

- COL. 23**  
 0 ZERO  
 1 ONE  
 2 TWO  
 3 THREE  
 4 FOUR  
 5 FIVE  
 6 SIX  
 7 SEVEN  
 8 EIGHT  
 9 NINE OR MORE  
 X REFUSED

6. How many people in the household commute to a job, or to college, at least 4 times a week?

- COL. 24** **SKIP TO**  
 0 ZERO Q. 12  
 1 ONE Q. 7  
 2 TWO Q. 7  
 3 THREE Q. 7  
 4 FOUR OR MORE Q. 7  
 5 DON'T KNOW/REFUSED Q. 12

INTERVIEWER: For each person identified in Question 6, ask Questions 7, 8, 9, and 10.

7. Thinking about commuter #1, how does that person usually travel to work or college? (REPEAT QUESTION FOR EACH COMMUTER.)

	Commuter #1 <b>COL. 25</b>	Commuter #2 <b>COL. 26</b>	Commuter #3 <b>COL. 27</b>	Commuter #4 <b>COL. 28</b>
Rail	1	1	1	1
Bus	2	2	2	2
Walk/Bicycle	3	3	3	3
Driver Car/Van	4	4	4	4
Park & Ride (Car/Rail, Xpress_bus)	5	5	5	5
Driver Carpool-2 or more people	6	6	6	6
Passenger Carpool-2 or more people	7	7	7	7
Taxi	8	8	8	8
Refused	9	9	9	9

8. What is the name of the city, town or community in which Commuter #1 works or attends school? (REPEAT QUESTION FOR EACH COMMUTER.) (FILL IN ANSWER.)

COMMUTER #1			COMMUTER #2			COMMUTER #3			COMMUTER #4		
City/Town	State		City/Town	State		City/Town	State		City/Town	State	
<b>COL. 29</b>	<b>COL. 30</b>	<b>COL. 31</b>	<b>COL. 32</b>	<b>COL. 33</b>	<b>COL. 34</b>	<b>COL. 35</b>	<b>COL. 36</b>	<b>COL. 37</b>	<b>COL. 38</b>	<b>COL. 39</b>	<b>COL. 40</b>
0	0	0	0	0	0	0	0	0	0	0	0
1	1	1	1	1	1	1	1	1	1	1	1
2	2	2	2	2	2	2	2	2	2	2	2
3	3	3	3	3	3	3	3	3	3	3	3
4	4	4	4	4	4	4	4	4	4	4	4
5	5	5	5	5	5	5	5	5	5	5	5
6	6	6	6	6	6	6	6	6	6	6	6
7	7	7	7	7	7	7	7	7	7	7	7
8	8	8	8	8	8	8	8	8	8	8	8
9	9	9	9	9	9	9	9	9	9	9	9



9. How long would it take Commuter #1 to travel home from work or college?  
 (REPEAT QUESTION FOR EACH COMMUTER.) (DO NOT READ ANSWERS.)

<u>COMMUTER #1</u>		<u>COMMUTER #2</u>	
<u>COL. 41</u>	<u>COL. 42</u>	<u>COL. 43</u>	<u>COL. 44</u>
1 5 MINUTES OR LESS	1 46-50 MINUTES	1 5 MINUTES OR LESS	1 46-50 MINUTES
2 6-10 MINUTES	2 51-55 MINUTES	2 6-10 MINUTES	2 51-55 MINUTES
3 11-15 MINUTES	3 56 - 1 HOUR	3 11-15 MINUTES	3 56 - 1 HOUR
4 16-20 MINUTES	4 OVER 1 HOUR, BUT	4 16-20 MINUTES	4 OVER 1 HOUR, BUT
5 21-25 MINUTES	LESS THAN 1 HOUR	5 21-25 MINUTES	LESS THAN 1 HOUR
6 26-30 MINUTES	15 MINUTES	6 26-30 MINUTES	15 MINUTES
7 31-35 MINUTES	5 BETWEEN 1 HOUR	7 31-35 MINUTES	5 BETWEEN 1 HOUR
8 36-40 MINUTES	16 MINUTES AND 1	8 36-40 MINUTES	16 MINUTES AND 1
9 41-45 MINUTES	HOUR 30 MINUTES	9 41-45 MINUTES	HOUR 30 MINUTES
	6 BETWEEN 1 HOUR		6 BETWEEN 1 HOUR
	31 MINUTES AND 1		31 MINUTES AND 1
	HOUR 45 MINUTES		HOUR 45 MINUTES
	7 BETWEEN 1 HOUR		7 BETWEEN 1 HOUR
	46 MINUTES AND		46 MINUTES AND
	2 HOURS		2 HOURS
	8 OVER 2 HOURS		8 OVER 2 HOURS
	(SPECIFY _____)		(SPECIFY _____)
	9		9
	0		0
	X DON'T KNOW/REFUSED		X DON'T KNOW/REFUSED

<u>COMMUTER #3</u>		<u>COMMUTER #4</u>	
<u>COL. 45</u>	<u>COL. 46</u>	<u>COL. 47</u>	<u>COL. 48</u>
1 5 MINUTES OR LESS	1 46-50 MINUTES	1 5 MINUTES OR LESS	1 46-50 MINUTES
2 6-10 MINUTES	2 51-55 MINUTES	2 6-10 MINUTES	2 51-55 MINUTES
3 11-15 MINUTES	3 56 - 1 HOUR	3 11-15 MINUTES	3 56 - 1 HOUR
4 16-20 MINUTES	4 OVER 1 HOUR, BUT	4 16-20 MINUTES	4 OVER 1 HOUR, BUT
5 21-25 MINUTES	LESS THAN 1 HOUR	5 21-25 MINUTES	LESS THAN 1 HOUR
6 26-30 MINUTES	15 MINUTES	6 26-30 MINUTES	15 MINUTES
7 31-35 MINUTES	5 BETWEEN 1 HOUR	7 31-35 MINUTES	5 BETWEEN 1 HOUR
8 36-40 MINUTES	16 MINUTES AND 1	8 36-40 MINUTES	16 MINUTES AND 1
9 41-45 MINUTES	HOUR 30 MINUTES	9 41-45 MINUTES	HOUR 30 MINUTES
	6 BETWEEN 1 HOUR		6 BETWEEN 1 HOUR
	31 MINUTES AND 1		31 MINUTES AND 1
	HOUR 45 MINUTES		HOUR 45 MINUTES
	7 BETWEEN 1 HOUR		7 BETWEEN 1 HOUR
	46 MINUTES AND		46 MINUTES AND
	2 HOURS		2 HOURS
	8 OVER 2 HOURS		8 OVER 2 HOURS
	(SPECIFY _____)		(SPECIFY _____)
	9		9
	0		0
	X DON'T KNOW/REFUSED		X DON'T KNOW/REFUSED

10. Approximately how long does it take Commuter #1 to complete preparation for leaving work or college prior to starting the trip home? (REPEAT QUESTION FOR EACH COMMUTER.) (DO NOT READ ANSWERS.)

<u>COMMUTER #1</u>		<u>COMMUTER #2</u>	
<u>COL. 49</u>	<u>COL. 50</u>	<u>COL. 51</u>	<u>COL. 52</u>
1 5 MINUTES OR LESS	1 46-50 MINUTES	1 5 MINUTES OR LESS	1 46-50 MINUTES
2 6-10 MINUTES	2 51-55 MINUTES	2 6-10 MINUTES	2 51-55 MINUTES
3 11-15 MINUTES	3 56 - 1 HOUR	3 11-15 MINUTES	3 56 - 1 HOUR
4 16-20 MINUTES	4 OVER 1 HOUR, BUT	4 16-20 MINUTES	4 OVER 1 HOUR, BUT
5 21-25 MINUTES	LESS THAN 1 HOUR	5 21-25 MINUTES	LESS THAN 1 HOUR
6 26-30 MINUTES	15 MINUTES	6 26-30 MINUTES	15 MINUTES
7 31-35 MINUTES	5 BETWEEN 1 HOUR	7 31-35 MINUTES	5 BETWEEN 1 HOUR
8 36-40 MINUTES	16 MINUTES AND 1	8 36-40 MINUTES	16 MINUTES AND 1
9 41-45 MINUTES	HOUR 30 MINUTES	9 41-45 MINUTES	HOUR 30 MINUTES
	6 BETWEEN 1 HOUR		6 BETWEEN 1 HOUR
	31 MINUTES AND 1		31 MINUTES AND 1
	HOUR 45 MINUTES		HOUR 45 MINUTES
	7 BETWEEN 1 HOUR		7 BETWEEN 1 HOUR
	46 MINUTES AND		46 MINUTES AND
	2 HOURS		2 HOURS
	8 OVER 2 HOURS		8 OVER 2 HOURS
	(SPECIFY _____)		(SPECIFY _____)
	9		9
	0		0
	X DON'T KNOW/REFUSED		X DON'T KNOW/REFUSED

<u>COMMUTER #3</u>		<u>COMMUTER #4</u>	
<u>COL. 53</u>	<u>COL. 54</u>	<u>COL. 55</u>	<u>COL. 56</u>
1 5 MINUTES OR LESS	1 46-50 MINUTES	1 5 MINUTES OR LESS	1 46-50 MINUTES
2 6-10 MINUTES	2 51-55 MINUTES	2 6-10 MINUTES	2 51-55 MINUTES
3 11-15 MINUTES	3 56 - 1 HOUR	3 11-15 MINUTES	3 56 - 1 HOUR
4 16-20 MINUTES	4 OVER 1 HOUR, BUT	4 16-20 MINUTES	4 OVER 1 HOUR, BUT
5 21-25 MINUTES	LESS THAN 1 HOUR	5 21-25 MINUTES	LESS THAN 1 HOUR
6 26-30 MINUTES	15 MINUTES	6 26-30 MINUTES	15 MINUTES
7 31-35 MINUTES	5 BETWEEN 1 HOUR	7 31-35 MINUTES	5 BETWEEN 1 HOUR
8 36-40 MINUTES	16 MINUTES AND 1	8 36-40 MINUTES	16 MINUTES AND 1
9 41-45 MINUTES	HOUR 30 MINUTES	9 41-45 MINUTES	HOUR 30 MINUTES
	6 BETWEEN 1 HOUR		6 BETWEEN 1 HOUR
	31 MINUTES AND 1		31 MINUTES AND 1
	HOUR 45 MINUTES		HOUR 45 MINUTES
	7 BETWEEN 1 HOUR		7 BETWEEN 1 HOUR
	46 MINUTES AND		46 MINUTES AND
	2 HOURS		2 HOURS
	8 OVER 2 HOURS		8 OVER 2 HOURS
	(SPECIFY _____)		(SPECIFY _____)
	9		9
	0		0
	X DON'T KNOW/REFUSED		X DON'T KNOW/REFUSED

11. When the commuters are away from home, is there a vehicle at home that is available for evacuation during any emergency?

<u>Col. 57</u>	
1	Yes
2	No
3	Don't Know/Refused

12. Would you await the return of family members prior to evacuating the area?

**Col. 58**

- 1 Yes
- 2 No
- 3 Don't Know/Refused

---

13. How many of the vehicles that are usually available to the household would your family use during an evacuation? (DO NOT READ ANSWERS.)

**COL. 59**

- 1 ONE
- 2 TWO
- 3 THREE
- 4 FOUR
- 5 FIVE
- 6 SIX
- 7 SEVEN
- 8 EIGHT
- 9 NINE OR MORE
- 0 ZERO (NONE)
- X REFUSED

---

14. How long would it take the family to pack clothing, secure the house, load the car, and complete preparations prior to evacuating the area? (DO NOT READ ANSWERS.)

**COL. 60**

- 1 LESS THAN 15 MINUTES
- 2 15-30 MINUTES
- 3 31-45 MINUTES
- 4 46 MINUTES - 1 HOUR
- 5 1 HOUR TO 1 HOUR 15 MINUTES
- 6 1 HOUR 16 MINUTES TO 1 HOUR 30 MINUTES
- 7 1 HOUR 31 MINUTES TO 1 HOUR 45 MINUTES
- 8 1 HOUR 46 MINUTES TO 2 HOURS
- 9 2 HOURS TO 2 HOURS 15 MINUTES
- 0 2 HOURS 16 MINUTES TO 2 HOURS 30 MINUTES
- X 2 HOURS 31 MINUTES TO 2 HOURS 45 MINUTES
- Y 2 HOURS 46 MINUTES TO 3 HOURS

**COL. 61**

- 1 3 HOURS TO 3 HOURS 15 MINUTES
- 2 3 HOURS 16 MINUTES TO 3 HOURS 30 MINUTES
- 3 3 HOURS 31 MINUTES TO 3 HOURS 45 MINUTES
- 4 3 HOURS 46 MINUTES TO 4 HOURS
- 5 4 HOURS TO 4 HOURS 15 MINUTES
- 6 4 HOURS 16 MINUTES TO 4 HOURS 30 MINUTES
- 7 4 HOURS 31 MINUTES TO 4 HOURS 45 MINUTES
- 8 4 HOURS 46 MINUTES TO 5 HOURS
- 9 5 HOURS TO 5 HOURS 15 MINUTES
- 0 5 HOURS 16 MINUTES TO 5 HOURS 30 MINUTES
- X 5 HOURS 31 MINUTES TO 5 HOURS 45 MINUTES
- Y 5 HOURS 46 MINUTES TO 6 HOURS

**COL. 62**

- 1 DON'T KNOW

---

15. Would you take household pets with you if you were asked to evacuate the area?

**Col. 58**

- 1 Yes
- 2 No
- 3 Don't Know/Refused

Thank you very much. \_\_\_\_\_  
(TELEPHONE NUMBER CALLED)

If requested:  
For Additional information  
Contact your County Emergency Management Office

**ANNEX B**  
**Code of Data Collection Standards With Notes Section**  
**Market Research Association**

P.O. Box 230 • Rocky Hill, CT 06067-0230 • 860-257-4008 • Fax: 860-257-3990

**Code Approved May 1997**  
**Notes Added September 1999**

**RESPONSIBILITIES TO RESPONDENTS**

**Data Collection Companies ...**

1. will make factually correct statements to secure cooperation and will honor promises to respondents, whether verbal or written;
2. will not use information to identify respondents without the permission of the respondent, except to those who check the data or are involved in processing the data. If such permission is given, it must be recorded by the interviewer at the time the permission is secured;
3. will respect the respondent's right to withdraw or to refuse to cooperate at any stage of the study and not use any procedure or technique to coerce or imply that cooperation is obligatory;
4. will obtain and document respondent consent when it is known that the name and address or identity of the respondent may be passed to a third party for legal or other purposes, such as audio or video recordings;
5. will obtain permission and document consent of a parent, legal guardian or responsible guardian before interviewing children 12 years old or younger;
6. will give respondents the opportunity to refuse to participate in the research when there is a possibility they may be identifiable even without the use of their name or address (e.g., because of the size of the population being sampled).

**Interviewers ...**

1. will treat the respondent with respect and not influence him or her through direct or indirect attempts, including the framing of questions and/or a respondent's opinion or attitudes on any issue;
2. will obtain and document permission from a parent, legal guardian or responsible guardian before interviewing children 12 years old or younger. Prior to obtaining permission, the interviewer should divulge the subject matter, length of the interview and other special tasks that will be required.

**RESPONSIBILITIES TO CLIENTS**

**Data Collection Companies ...**

1. will ensure that each study is conducted according to the client's exact specifications;
2. will observe confidentiality with all research techniques or methodologies and with information considered confidential or proprietary. Information will not be revealed that could be used to identify clients or respondents without proper authorization;
3. will ensure that companies, their employees and subcontractors involved in data collection take all reasonable precautions so that more than one survey is not conducted in one interview without explicit permission from the Client
4. will report research results accurately and honestly;
5. will not misrepresent themselves as having qualifications, experience, skills or facilities that they do not possess;
6. will refrain from referring to membership in the Marketing Research Association as proof of competence, since the Association does not certify any person's or organization's competency or skill level.

**RESPONSIBILITIES TO DATA COLLECTORS**

**Clients ...**

1. will be responsible for providing products and services that are safe and fit or their intended use and disclose/label all product contents;
2. will provide verbal or written instructions;
3. will not ask our members who subcontract research to engage in any activity that is not acceptable as defined in this Code or that is prohibited under any applicable federal, state, local laws, regulations and/or ordinances.

## RESPONSIBILITIES TO THE GENERAL PUBLIC AND BUSINESS COMMUNITY

### Data Collection Companies ...

1. will not intentionally abuse public confidence in marketing and opinion research;
2. will not represent a non-research activity to be marketing and opinion research, such as:
  - questions whose sole objective is to obtain personal information about respondents, whether for legal, political, private or other purposes,
  - the compilation of lists, registers or data banks of names and addresses for any non-research purposes (e.g., canvassing or fundraising),
  - industrial, commercial or any other form of espionage,
  - the acquisition of information for use by credit rating services or similar organizations,
  - sales or promotional approaches to the respondent,
  - the collection of debts;
3. will make interviewers aware of any special conditions that may be applicable to any minor (18 years old or younger).

*These notes are intended to help users of the Code to interpret and apply it in practice. Any questions about how to apply the Code in a specific situation should be addressed to MRA Headquarters.*

## RESPONSIBILITIES TO RESPONDENTS

### Data Collection Companies ...

1. will make factually correct statements to secure cooperation and honor promises to respondents, whether oral or written; *Interviewers will not knowingly provide respondents with information that misrepresents any portion of the interviewing process, such as; length of the interview, scope of task involved, compensation, or intended use of the information collected.*
2. will not use information to identify respondents without the permission of the respondent, except to those who check the data or are involved in processing the data. If such permission is given, it must be recorded by the interviewer at the time the permission is secured; *Respondent information will be linked to data collected only for research purposes such as validation, evaluating data in aggregate based on demographic information, modeling. Providing respondent information is not permissible for any purpose other than legitimate research purposes as mentioned above. If anyone requests respondent identifiable information it will only be provided upon receipt of written declaration of and agreement of some intended use. Such use shall be determined by the provider to qualify as legitimate research use. (i.e. validation, planned recalls, modeling, demographic analysis.) No other use of this information falls within the boundaries of the Code. This applies to all types of respondent sample sources including client supplied lists.*
3. will respect the respondent's right to withdraw or to refuse to cooperate at any stage of the study and not use any procedure or technique to coerce or imply that cooperation is obligatory. *Respondent cooperation is strictly on a voluntary basis. Respondents are entitled to withdraw from an interview at any stage or to refuse to cooperate in a research project. Interviewers should never lead respondents to believe they have no choice in their participation.*
4. will obtain and record respondent consent when it is known that the name and addresses or identity of the respondent may be passed to a third party for legal or other purposes, such as audio or video recordings; *By documenting the respondent's consent for a defined specific use of his/ her name and address we are confirming the respondent realizes we are asking something new of them, i.e., possible participation in another research project.*
5. will obtain permission and document consent of a parent, legal guardian or responsible guardian before interviewing children 12 years old or younger; *Interviewers must take special care when interviewing children or young people. The informed consent of the parent or responsible adult must first be obtained for interviews with children.*
6. will give respondents the opportunity to refuse to participate in the research when there is a possibility they may be identifiable even without the use of their name or address (e.g., because of the size of the population being sampled.) *Respondent cooperation is strictly on a voluntary basis. Respondents are entitled to withdraw from a research project. Company policies and/or interviewer instructions should state the interviewer must give respondents the opportunity to not participate for any reason.*

#### **Interviewers ...**

1. will treat the respondent with respect and not influence him or her through direct or indirect attempts, including the framing of questions, a respondent's opinion or attitudes on any issue. *Interviewers cannot ask questions in a way that leads or influences respondents' answers, nor can they provide their own opinions, thoughts or feelings that might bias a respondent and therefore impact the answers they give.*
2. will obtain and document permission of a parent, legal guardian or responsible guardian before interviewing children 12 years old or younger. Prior to obtaining permission, the interviewer should divulge the subject matter, length of interview and other special tasks that will be required. *Interviewers must take special care when interviewing children and young people. The informed consent of the parent or responsible adult must first be obtained for interviews with children. Parents or responsible adults must be told some specifics about the interview process and special tasks, such as audio or video recording, taste testing, respondent fees and special tasks, before permission is obtained.*

#### **RESPONSIBILITIES TO CLIENTS**

##### **Data Collection Companies ...**

1. will ensure that each study is conducted according to the client's specifications; *Procedures are implemented to conform or verify that client specifications are being followed.*
2. will observe confidentiality with all research techniques or methodologies and with information considered confidential or proprietary. Information will not be revealed that could be used to identify clients or respondents without proper authorization; *Respondent information will be linked to data collected only for research purposes and will not be used for any purpose other than legitimate research. Protect the confidentiality of anything learned about the respondent and/or his or her business.*
3. will ensure that companies, their employees and subcontractors involved in data collection take all reasonable precautions so that no more than one survey is conducted in one interview without explicit permission from the sponsorship company or companies; *Company policies or procedures indicate the practice of conducting more than one survey within an interview is not done without specific permission from the relevant clients.*
4. will report research results accurately and honestly; *Describe how the research was done in enough detail that a skilled researcher could repeat the study; provide data representative of a defined population or activity and enough data to yield projectable results; present the results understandably and fairly, including any results that may seem contradictory or unfavorable.*
5. will not misrepresent themselves as having qualifications, experience, skills or facilities that they do not possess; *If regularly subcontracting data collection, should not infer to clients and prospective clients that they possess this capability "in house"; claim only legitimate academic degrees, clients and other qualifications.*
6. will refrain from referring to membership in the Marketing Research Association as proof of competence, since the Association does not certify any person's or organization's competency or skill level. *MRA does not currently have a certification program for marketing research competency, therefore while members can state their membership in the Association, they cannot claim that this automatically conveys a message of their competency to carry out the marketing research process.*

#### **RESPONSIBILITIES TO DATA COLLECTORS**

##### **Clients ...**

1. will be responsible for providing products and services that are safe and fit for their intended use and disclose/label all product contents; *It is the client's responsibility to ensure that all test products are in compliance with all safety standards and that all product contents information is provided to the data collectors. Data Collectors should request in writing all pertinent information as well as emergency numbers for respondents and themselves.*
2. will provide oral or written instructions; *To ensure the success of the research, detailed instructions are to be provided prior to the start of any project. These instructions must be written and then confirmed orally for: understanding, ability of the agency to implement and agreement to comply.*
3. will not ask our members who subcontract research to engage in any activity that is not acceptable as defined in this Code or that is prohibited under any applicable federal, state and local laws, regulations and ordinances. *All MRA Members have agreed to comply with the Code as written and thus will not agree to, or ask anyone else to, knowingly violate any of the points of the Code.*

## RESPONSIBILITIES TO THE GENERAL PUBLIC AND BUSINESS COMMUNITY

### **Data Collection Companies ...**

1. will not intentionally abuse public confidence in marketing and opinion research; *Marketing research shall be conducted and reported for the sole purpose of providing factual information upon which decisions will be made. At no time is marketing research information to be used to intentionally mislead public opinion. Instances of abuse of public confidence undermine the credibility of our Industry.*
2. will not represent a non-research activity to be marketing and opinion research, such as:
  - questions whose sole objective is to obtain personal information about respondents, whether for legal, political, private or other purposes,
  - the compilation of lists, registers or data banks of names and addresses for any non-research purposes (e.g., canvassing or fundraising),
  - industrial, commercial or any other form of espionage,
  - the acquisition of information for use by credit rating services or similar organizations,
  - sales or promotional approaches to the respondent,

APPENDIX G

Traffic Control



## APPENDIX G: TRAFFIC CONTROL

This appendix presents the traffic control tactics implemented in developing evacuation time-estimates for STP.

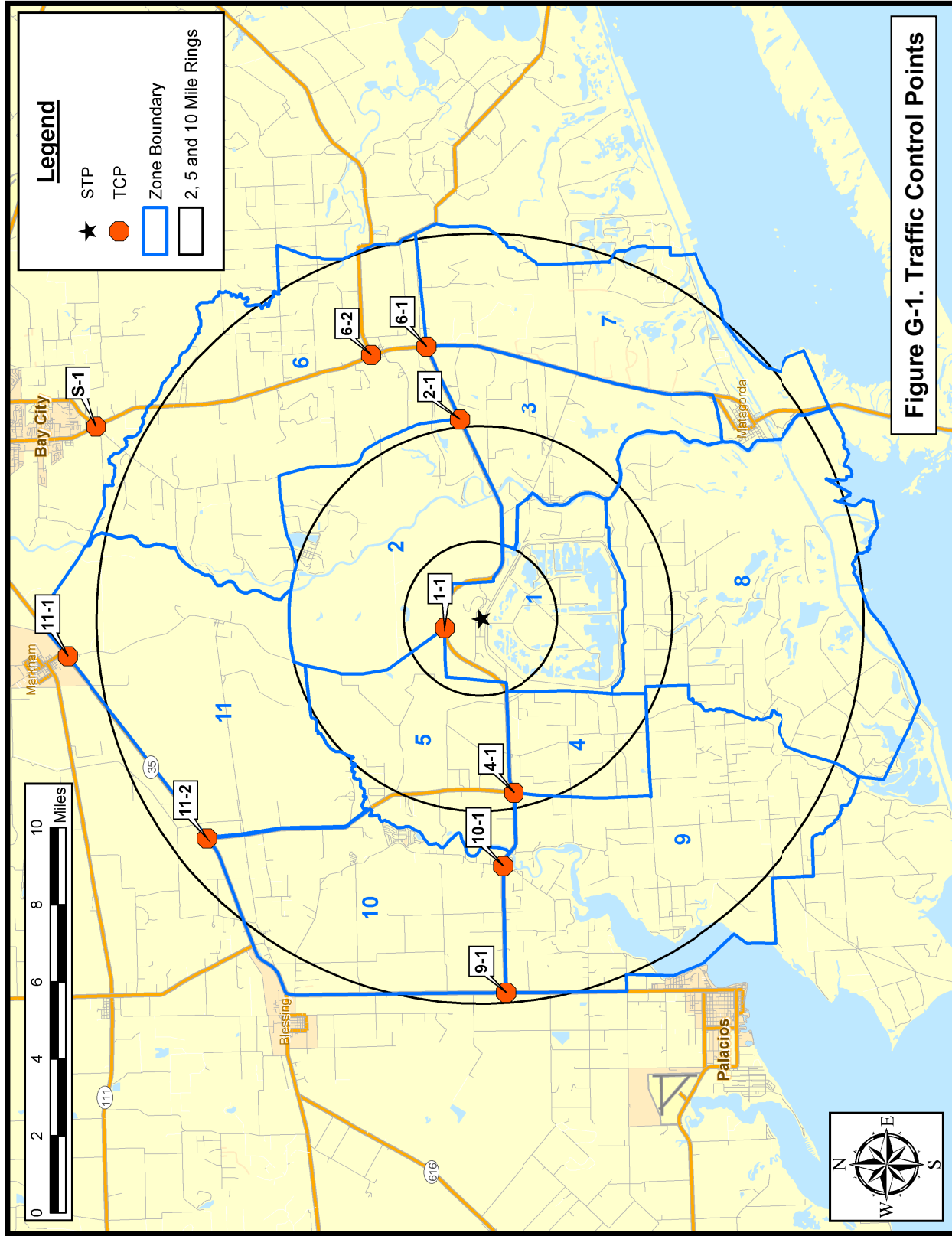


Table G-1. Traffic Control Points					
Priority	TCP ID #	Town	Intersection Location	# of Guides	# of Cones
1	S-1	Bay City	FM 2668 & STHY 60	2	6
1	1-1	Simpsonville	FM 521 & FM 1468/Buckeye Rd	1	3
1	2-1	Wadsworth	FM 521 & FM 2668	1	3
1	4-1	Simpsonville	FM 521 & STHY 1095	1	6
1	6-1	Wadsworth	FM 521 & STHY 60	1	3
1	6-2	Wadsworth	FM 521 & STHY 60	1	3
1	9-1	Blessing	FM 521 & STHY 35	1	3
1	10-1	Ashby	FM 521 & FM 2853	1	6
1	11-1	Markham	FM 1468 & STHY 35	1	3
1	11-2	Elmaton	FM 1095 & STHY 35	1	3
<b>Total Manpower &amp; Equipment for EPZ</b>				<b>11</b>	<b>39</b>

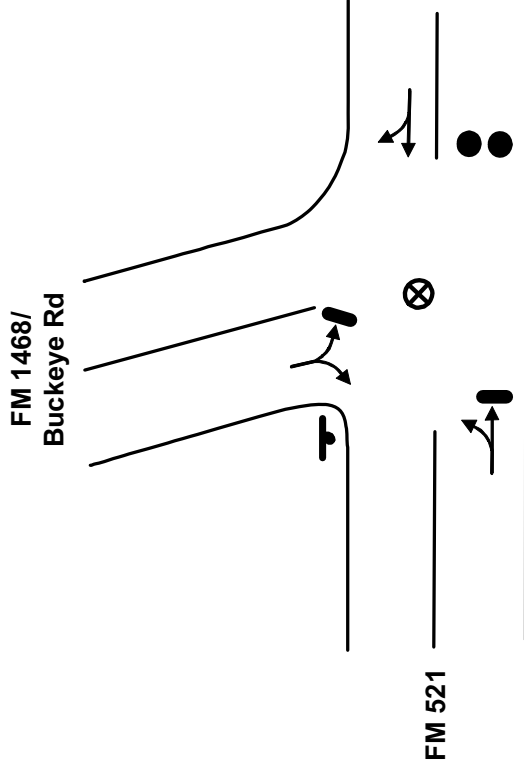
# TCP

TOWN: SIMPSONVILLE

LOCATION: FM 521 & FM 1468/BUCKEYE RD

TCP ID: 1-1

ERPA: 1



KEY

- MOVEMENT FACILITATED
- MOVEMENT DISCOURAGED/DIVERTED
- ⊗ TRAFFIC GUIDE
- STOP SIGN
- ⊗ TRAFFIC BARRICADE
- 2 PER LANE (LOCAL ROADS AND RAMPS)
- 4 PER LANE (FREEWAY AND RAMPS)
- TRAFFIC SIGNAL
- TRAFFIC CONES SPACED TO DISCOURAGE TRAFFIC BUT ALLOW PASSAGE (3 PER LANE): ● ● ● 8 ft

ACTIONS TO BE TAKEN

1. Discourage eastbound movement on FM 521

MANPOWER/EQUIPMENT ESTIMATE

- 1 Traffic Guide(s)
- 3 Traffic Cones

LOCATION PRIORITY

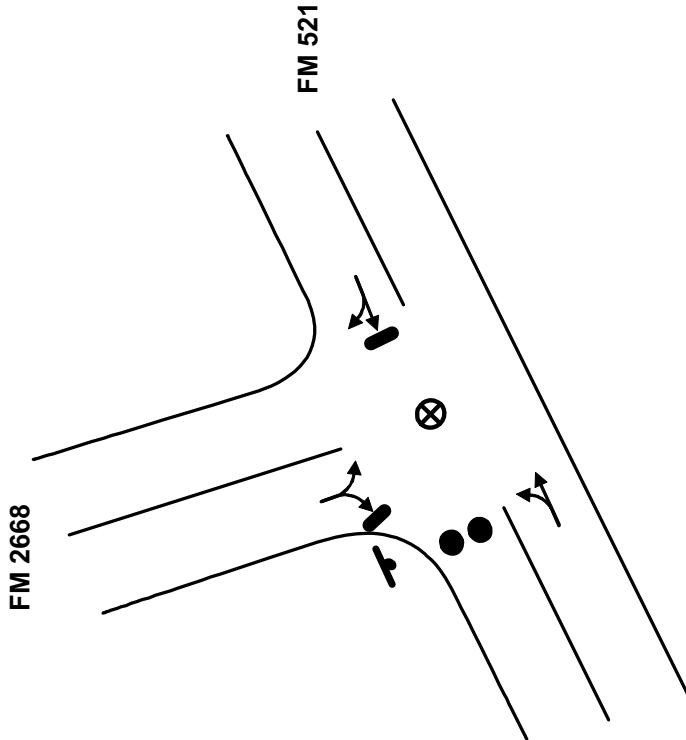
1



**\*\*Traffic Guide should position himself safely**

# TCP

TOWN: WADSWORTH  
LOCATION: FM 521 & FM 2668  
TCP ID: 2-1  
ERPA: 2



- KEY
- MOVEMENT FACILITATED
  - MOVEMENT DISCOURAGED/DIVERTED
  - ⊗ TRAFFIC GUIDE
  - ⊘ STOP SIGN
  - ✕ TRAFFIC BARRICADE
  - 2 PER LANE (LOCAL ROADS AND RAMPS)
  - 4 PER LANE (FREEWAY AND RAMPS)
  - 🚦 TRAFFIC SIGNAL
  - TRAFFIC CONES SPACED TO DISCOURAGE TRAFFIC BUT ALLOW PASSAGE (3 PER LANE): ● 8 ft

ACTIONS TO BE TAKEN

1. Discourage westbound movement on FM 521

MANPOWER/EQUIPMENT ESTIMATE

- 1 Traffic Guide(s)
- 3 Traffic Cones

LOCATION PRIORITY

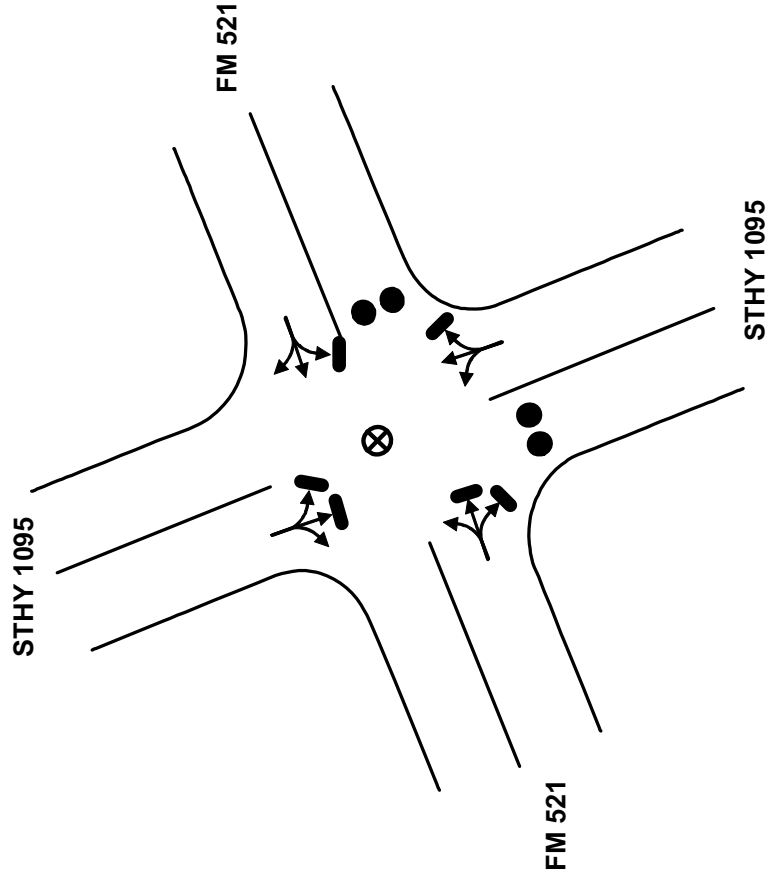
1



**\*\*Traffic Guide should position himself safely**

# TCP

TOWN: SIMPSONVILLE  
LOCATION: FM 521 & STHY 1095  
TCP ID: 4-1  
ERPA: 4



**\*\*Traffic Guide should position himself safely**

KEY

- MOVEMENT FACILITATED
- MOVEMENT DISCOURAGED/DIVERTED
- ⊗ TRAFFIC GUIDE
- STOP SIGN
- × TRAFFIC BARRICADE
- 2 PER LANE (LOCAL ROADS AND RAMPS)
- 4 PER LANE (FREEWAY AND RAMPS)
- TRAFFIC SIGNAL
- TRAFFIC CONES SPACED TO DISCOURAGE TRAFFIC BUT ALLOW PASSAGE (3 PER LANE): ● ● ● 8 ft

ACTIONS TO BE TAKEN

1. Discourage eastbound movement on FM 521
2. Discourage southbound movement on STHY 1095

MANPOWER/EQUIPMENT ESTIMATE

- 1 Traffic Guide(s)
- 6 Traffic Cones

LOCATION PRIORITY

1

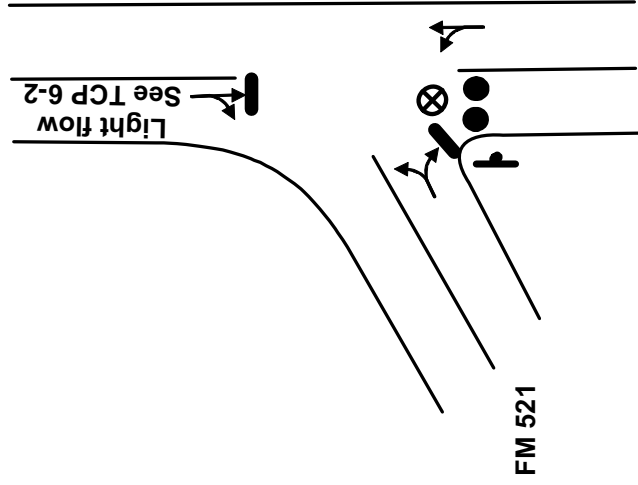
# TCP

TOWN: WADSWORTH  
LOCATION: FM 521 & STHY 60  
TCP ID: 6-1  
ERPA: 6

## KEY

- MOVEMENT FACILITATED
- MOVEMENT DISCOURAGED/DIVERTED
- ⊗ TRAFFIC GUIDE
- ⬇ STOP SIGN
- ⊗ TRAFFIC BARRICADE
- 2 PER LANE (LOCAL ROADS AND RAMPS)
- 4 PER LANE (FREEWAY AND RAMPS)
- 🚦 TRAFFIC SIGNAL
- TRAFFIC CONES SPACED TO DISCOURAGE TRAFFIC BUT ALLOW PASSAGE (3 PER LANE): ● ● ● 8 ft

STHY 60



STHY 60

## ACTIONS TO BE TAKEN

1. Discourage southbound movement on STHY 60
2. Permit westbound movement on FM 521; traffic will be turned north at TCP 2-1

## MANPOWER/EQUIPMENT ESTIMATE

- 1 Traffic Guide(s)
- 3 Traffic Cones

## LOCATION PRIORITY

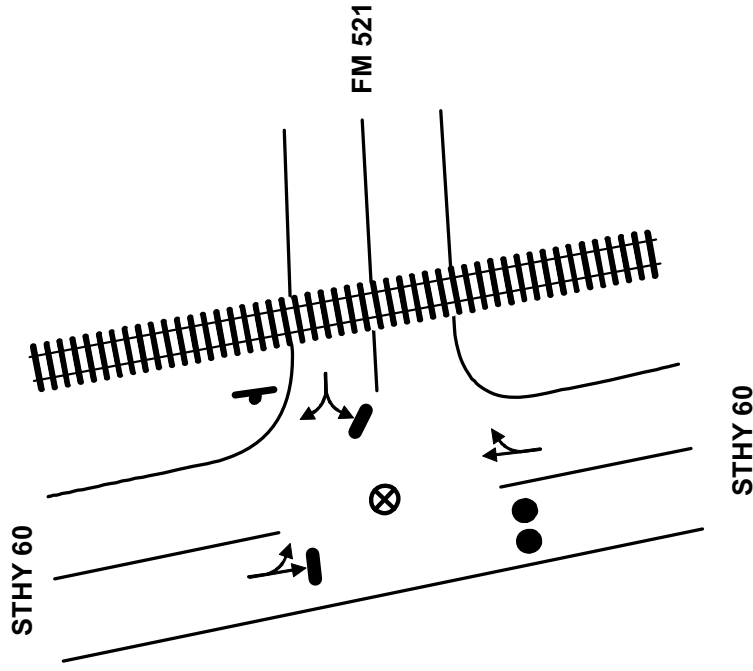
1

**\*\*Traffic Guide should position himself safely**



# TCP

TOWN: WADSWORTH  
LOCATION: FM 521 & STHY 60  
TCP ID: 6-2  
ERPA: 6



- KEY
- MOVEMENT FACILITATED
  - MOVEMENT DISCOURAGED/DIVERTED
  - ⊗ TRAFFIC GUIDE
  - ⊘ STOP SIGN
  - ⊗ TRAFFIC BARRICADE
  - 2 PER LANE (LOCAL ROADS AND RAMPS)
  - 4 PER LANE (FREEWAY AND RAMPS)
  - 🚦 TRAFFIC SIGNAL
  - TRAFFIC CONES SPACED TO DISCOURAGE TRAFFIC BUT ALLOW PASSAGE (3 PER LANE): ● ● ● 8 ft

ACTIONS TO BE TAKEN

1. Discourage southbound movement on STHY 60

MANPOWER/EQUIPMENT ESTIMATE

- 1 Traffic Guide(s)
- 3 Traffic Cones

LOCATION PRIORITY

1



**\*\*Traffic Guide should position himself safely**



# TCP

TOWN: BLESSING

LOCATION: FM 521 & STHY 35

TCP ID: 9-1

ERPA: 9

KEY

- MOVEMENT FACILITATED
- MOVEMENT DISCOURAGED/DIVERTED
- ⊗ TRAFFIC GUIDE
- STOP SIGN
- ⊗ TRAFFIC BARRICADE
- 2 PER LANE (LOCAL ROADS AND RAMPS)
- 4 PER LANE (FREEWAY AND RAMPS)
- TRAFFIC SIGNAL
- TRAFFIC CONES SPACED TO DISCOURAGE TRAFFIC BUT ALLOW PASSAGE (3 PER LANE): ● ● ● 8 ft

ACTIONS TO BE TAKEN

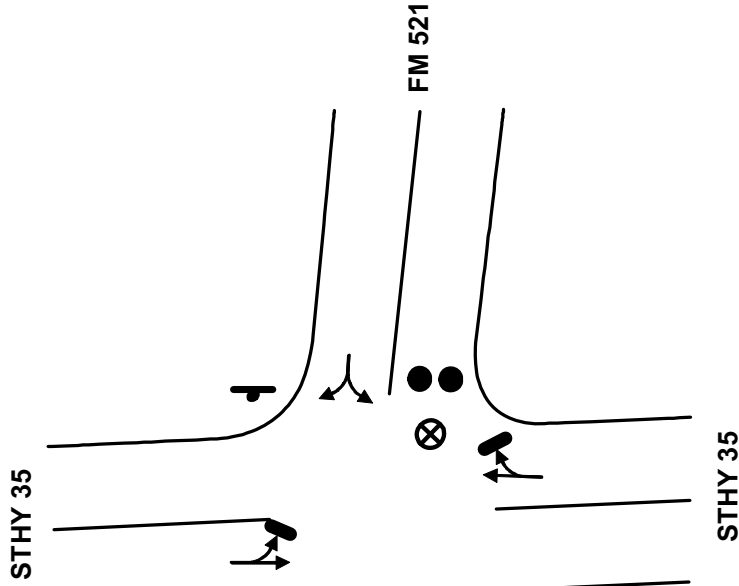
1. Discourage eastbound movement on FM 521

MANPOWER/EQUIPMENT ESTIMATE

- 1 Traffic Guide(s)
- 3 Traffic Cones

LOCATION PRIORITY

1



**\*\*Traffic Guide should position himself safely**

# TCP

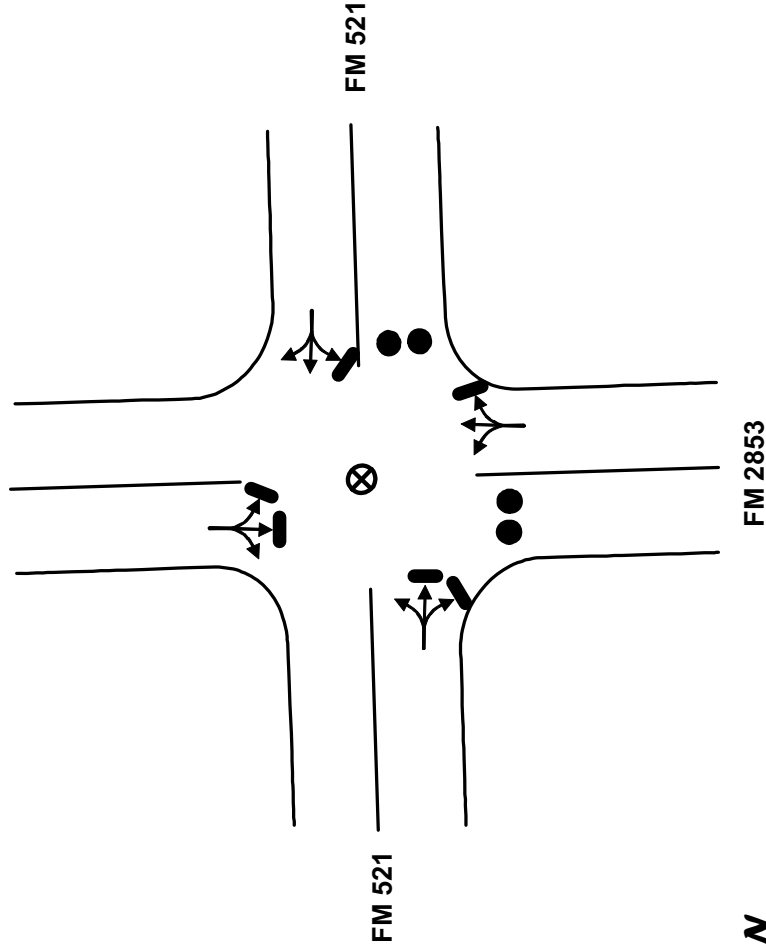
TOWN: ASHBY

LOCATION: FM 521 & FM 2853

TCP ID: 10-1

ERPA: 10

FM 2853



**\*\*Traffic Guide should position himself safely**

KEY

- MOVEMENT FACILITATED
- MOVEMENT DISCOURAGED/DIVERTED
- ⊗ TRAFFIC GUIDE
- ⊘ STOP SIGN
- ⊗ TRAFFIC BARRICADE
- 2 PER LANE (LOCAL ROADS AND RAMP)
- 4 PER LANE (FREEWAY AND RAMP)
- TRAFFIC SIGNAL
- TRAFFIC CONES SPACED TO DISCOURAGE TRAFFIC BUT ALLOW PASSAGE (3 PER LANE): ● ● ● 8 ft

ACTIONS TO BE TAKEN

1. Discourage eastbound movement on FM 521
2. Discourage southbound movement on FM 2853

MANPOWER/EQUIPMENT ESTIMATE

- 1 Traffic Guide(s)
- 6 Traffic Cones

LOCATION PRIORITY

1

# TCP

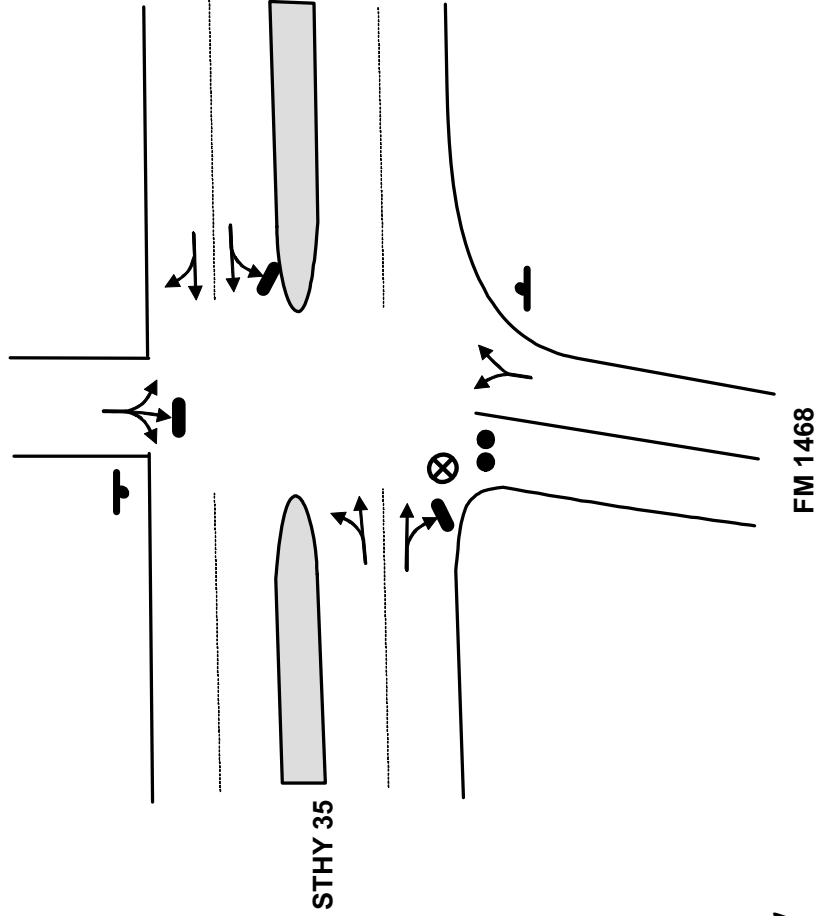
TOWN: MARKHAM

LOCATION: FM 1468 & STHY 35

TCP ID: 11-1

ERPA: 11

Driveway



STHY 35

ACTIONS TO BE TAKEN

1. Discourage southbound movement on FM 1468

- KEY
- MOVEMENT FACILITATED
  - MOVEMENT DISCOURAGED/DIVERTED
  - ⊗ TRAFFIC GUIDE
  - ⊘ STOP SIGN
  - ⊗ TRAFFIC BARRICADE
  - 2 PER LANE (LOCAL ROADS AND RAMPS)
  - 4 PER LANE (FREEWAY AND RAMPS)
  - TRAFFIC SIGNAL
  - TRAFFIC CONES SPACED TO DISCOURAGE TRAFFIC BUT ALLOW PASSAGE (3 PER LANE): ● 8 ft

MANPOWER/EQUIPMENT ESTIMATE

- 1 Traffic Guide(s)
- 3 Traffic Cones

LOCATION PRIORITY

1

**\*\*Traffic Guide should position himself safely**

# TCP

TOWN: ELMATON

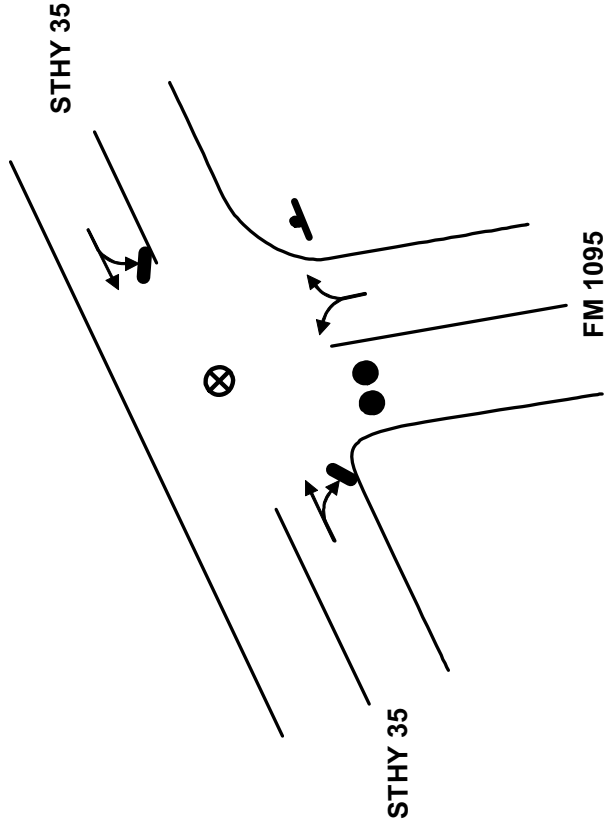
LOCATION: FM 1095 & STHY 35

TCP ID: 11-2

ERPA: 11

## KEY

- MOVEMENT FACILITATED
- MOVEMENT DISCOURAGED/DIVERTED
- ⊗ TRAFFIC GUIDE
- ⬇ STOP SIGN
- ✕ TRAFFIC BARRICADE
- 2 PER LANE (LOCAL ROADS AND RAMPS)
- 4 PER LANE (FREEWAY AND RAMPS)
- 🚦 TRAFFIC SIGNAL
- TRAFFIC CONES SPACED TO DISCOURAGE TRAFFIC BUT ALLOW PASSAGE (3 PER LANE): ● ● ● 8 ft



## ACTIONS TO BE TAKEN

1. Discourage southbound movement on FM 1095

## MANPOWER/EQUIPMENT ESTIMATE

- 1 Traffic Guide(s)
- 3 Traffic Cones

## LOCATION PRIORITY

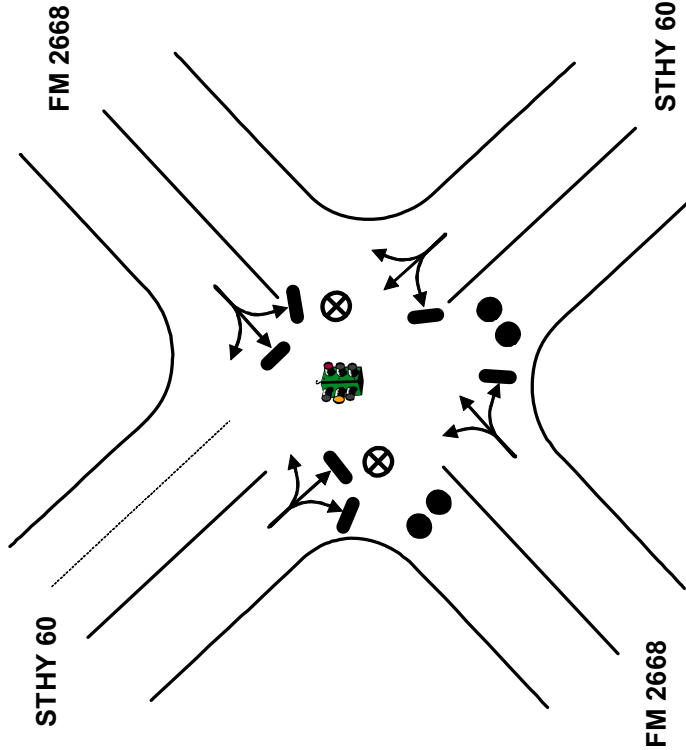
1



**\*\*Traffic Guide should position himself safely**

# TCP

TOWN: BAY CITY  
LOCATION: FM 2668 & STHY 60  
TCP ID: S-1  
ERPA: Shadow



- KEY
- MOVEMENT FACILITATED
  - MOVEMENT DISCOURAGED/DIVERTED
  - ⊗ TRAFFIC GUIDE
  - ⊘ STOP SIGN
  - ⊗ TRAFFIC BARRICADE
  - 2 PER LANE (LOCAL ROADS AND RAMP)
  - 4 PER LANE (FREEWAY AND RAMP)
  - 🚦 TRAFFIC SIGNAL
  - TRAFFIC CONES SPACED TO DISCOURAGE TRAFFIC BUT ALLOW PASSAGE (3 PER LANE): ● 8 ft

ACTIONS TO BE TAKEN

1. Discourage southbound movement on STHY 60
2. Discourage southbound movement on FM 2668

MANPOWER/EQUIPMENT ESTIMATE

- 2 Traffic Guide(s)
- 6 Traffic Cones

LOCATION PRIORITY

1

**\*\*Traffic Guide should position himself safely**

APPENDIX H

Evacuation Regions

|

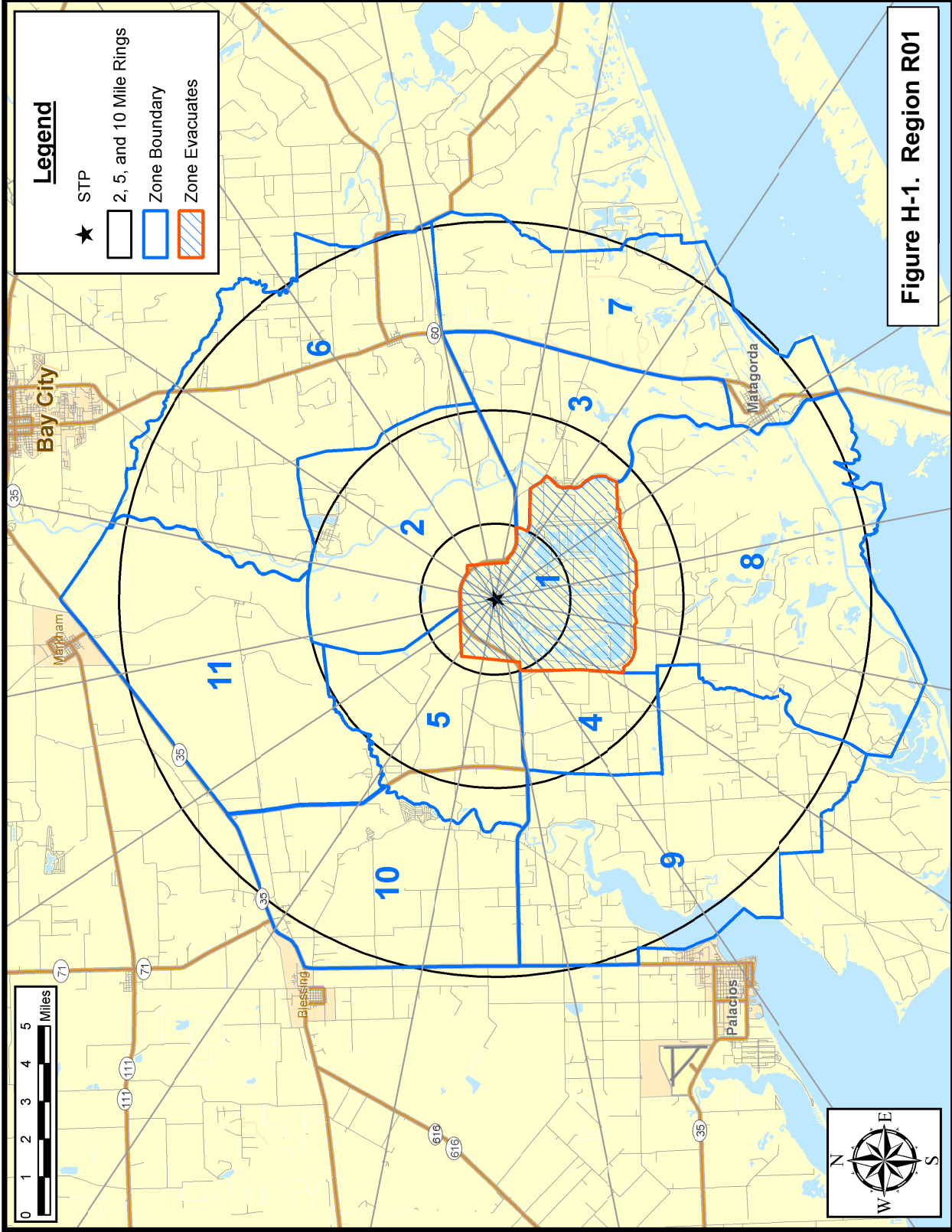
## APPENDIX H: EVACUATION REGIONS

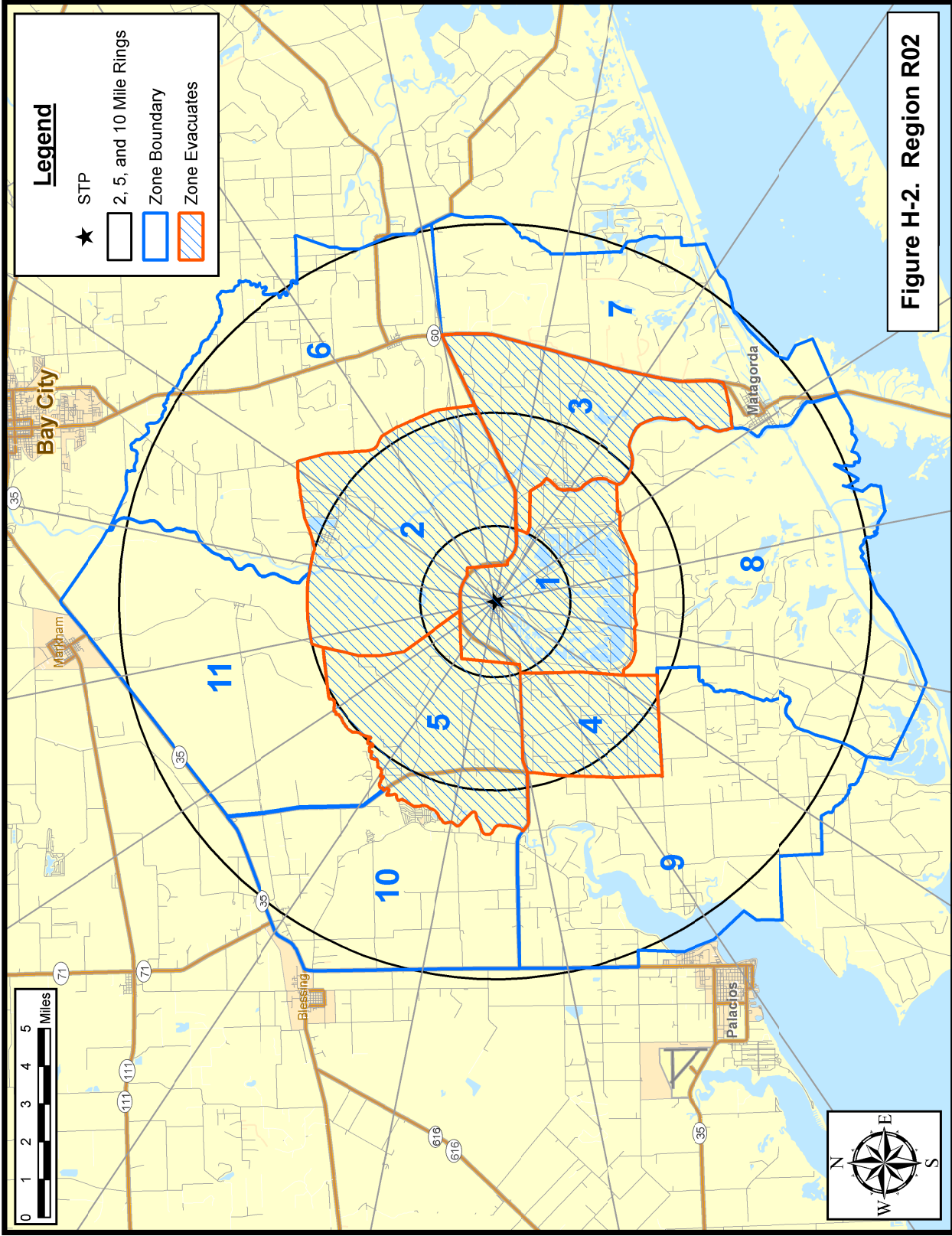
This appendix presents the assumed voluntary evacuation percentages for each Evacuation Region (Table H-1) based on assumption 5 in Section 2.2, shown graphically in Figure 2-1. Maps of all Evacuation Regions are presented as Figures H-1 through H-22.

Table H-1. Percent of Zone Population Evacuating for Each Region

ZONE	REGION																					
	2-Mile Ring, 5-Mile Ring, Entire EPZ		2-Mile Radius and Downwind to 5-Miles										5-Mile Radius and Downwind to EPZ Boundary									
	1	2	3	4	5	6	7	8	9	10	11	12	13	14	15	16	17	18	19	20	21	22
1	100%	100%	100%	100%	100%	100%	100%	100%	100%	100%	100%	100%	100%	100%	100%	100%	100%	100%	100%	100%	100%	100%
2	35%	100%	100%	50%	50%	100%	100%	100%	50%	100%	100%	100%	100%	100%	100%	100%	100%	100%	100%	100%	100%	100%
3	35%	100%	100%	50%	50%	50%	50%	100%	100%	100%	100%	100%	100%	100%	100%	100%	100%	100%	100%	100%	100%	100%
4	35%	100%	100%	100%	100%	50%	50%	50%	50%	100%	100%	100%	100%	100%	100%	100%	100%	100%	100%	100%	100%	100%
5	35%	100%	100%	50%	100%	100%	100%	50%	50%	100%	100%	100%	100%	100%	100%	100%	100%	100%	100%	100%	100%	100%
6	35%	35%	100%	35%	35%	35%	35%	35%	35%	50%	50%	50%	50%	50%	100%	100%	100%	100%	100%	50%	50%	50%
7	35%	35%	100%	35%	35%	35%	35%	35%	35%	50%	50%	50%	50%	50%	50%	50%	50%	50%	100%	100%	100%	100%
8	35%	35%	100%	35%	35%	35%	35%	35%	35%	100%	100%	100%	100%	100%	50%	50%	50%	50%	50%	50%	100%	100%
9	35%	35%	100%	35%	35%	35%	35%	35%	35%	100%	100%	100%	100%	100%	50%	50%	50%	50%	50%	50%	50%	100%
10	35%	35%	100%	35%	35%	35%	35%	35%	35%	50%	100%	100%	100%	100%	100%	100%	50%	50%	50%	50%	50%	50%
11	35%	35%	100%	35%	35%	35%	35%	35%	35%	50%	50%	50%	50%	100%	100%	100%	100%	100%	50%	50%	50%	50%







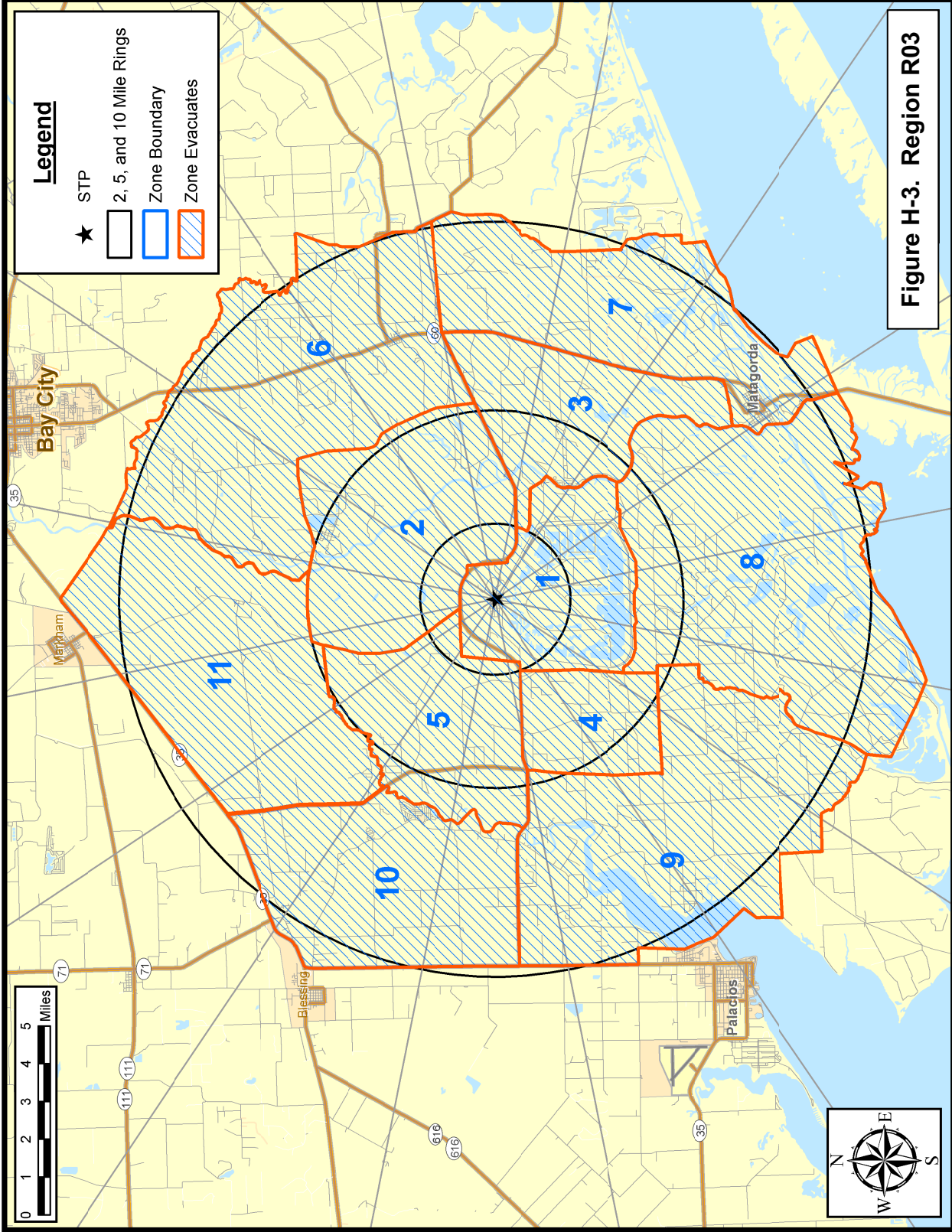
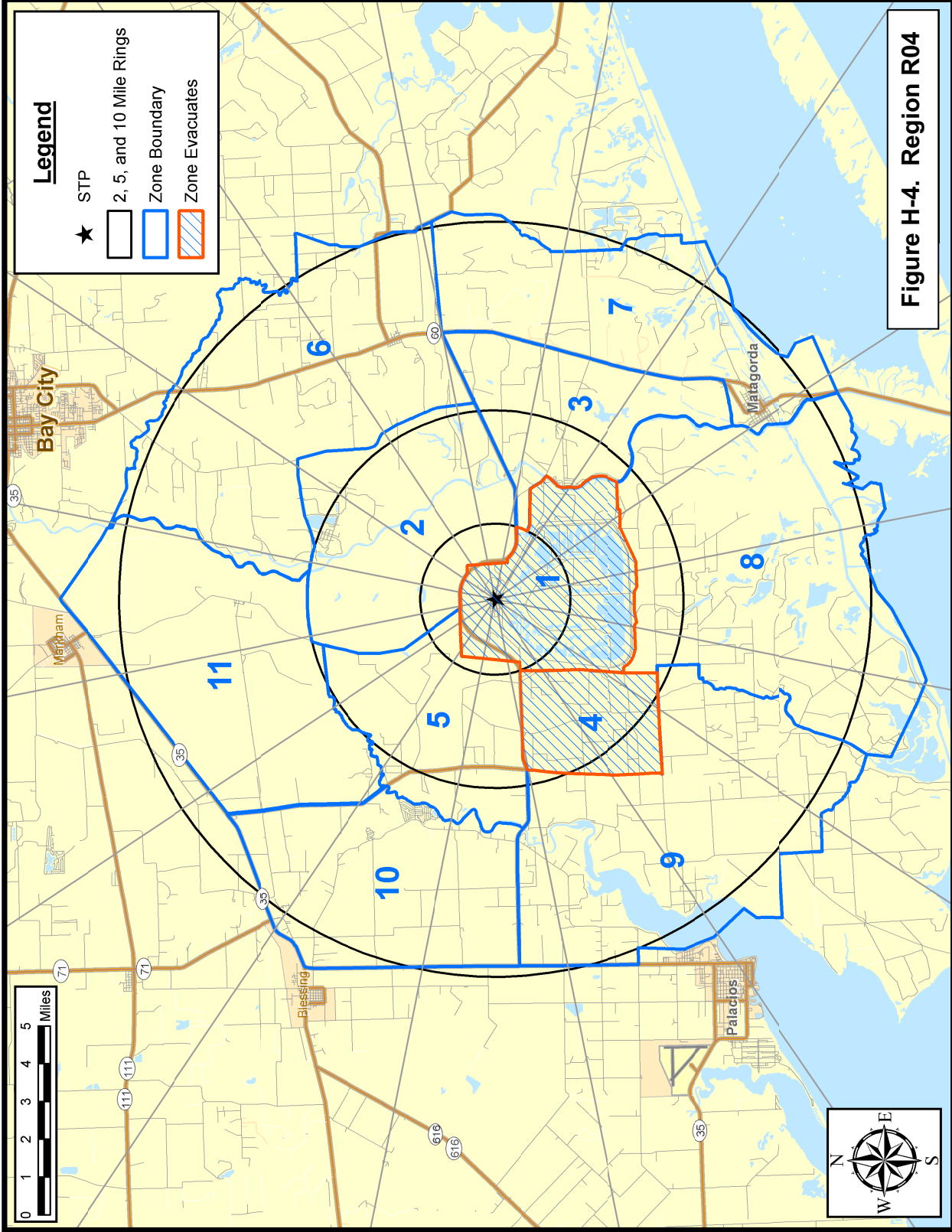
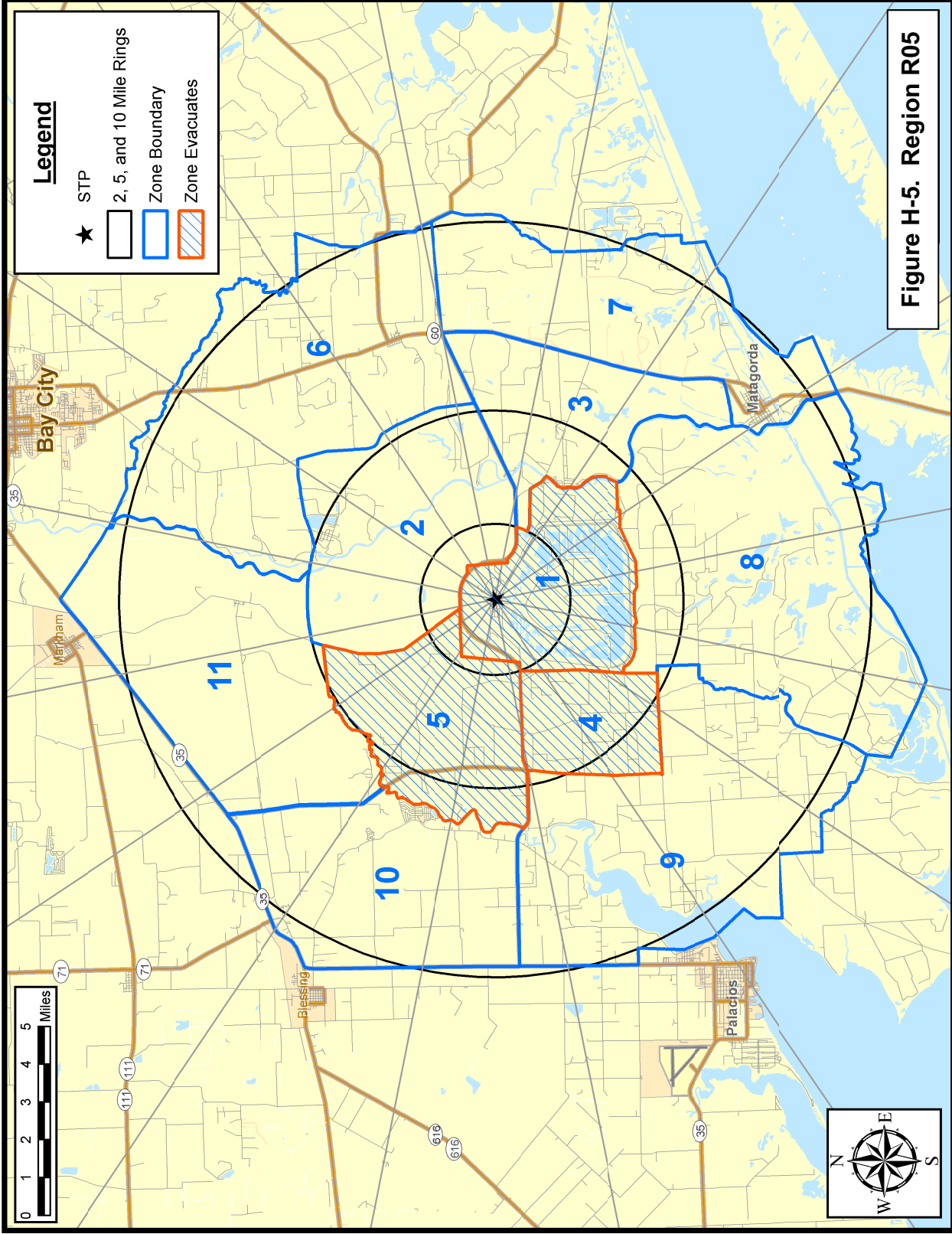
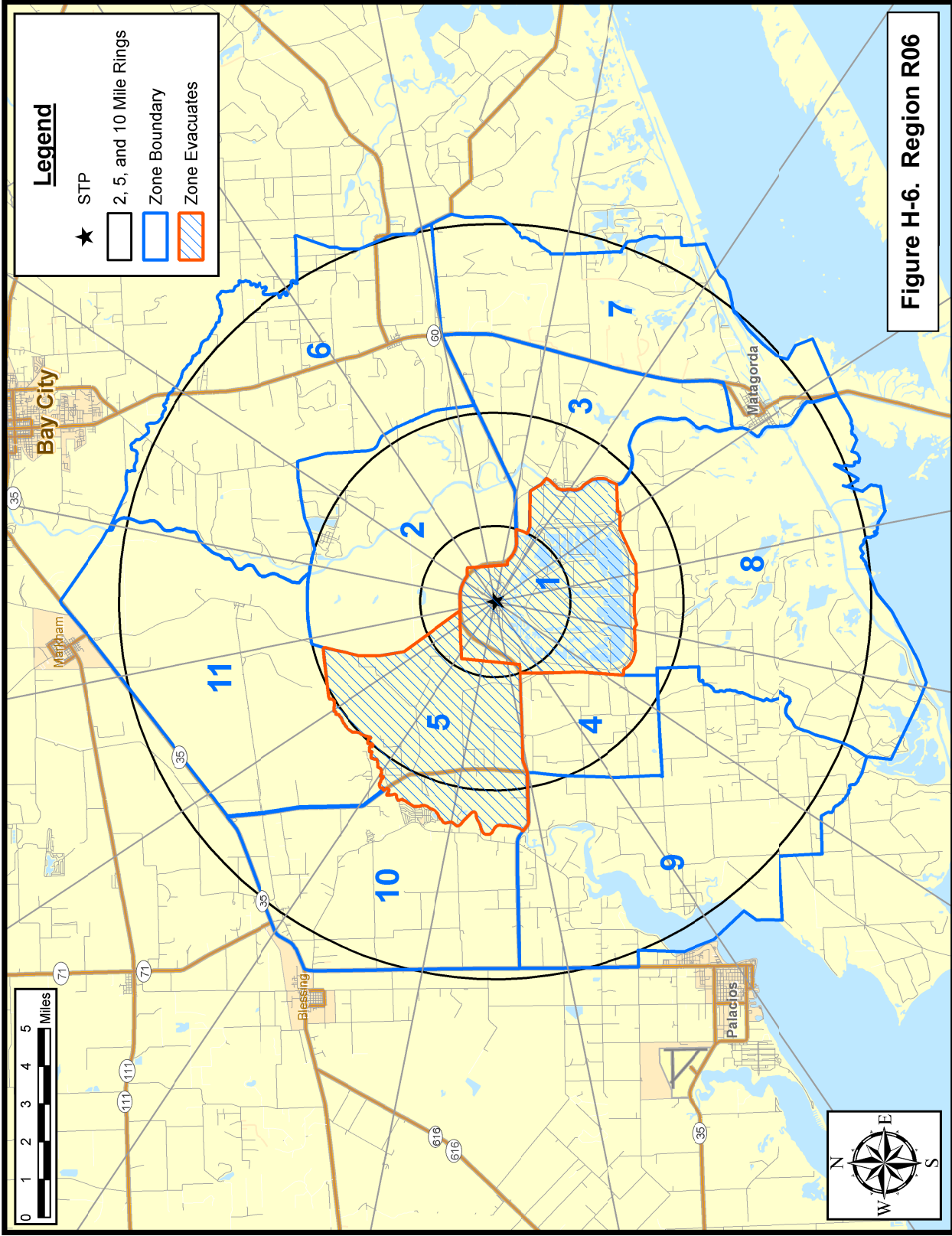


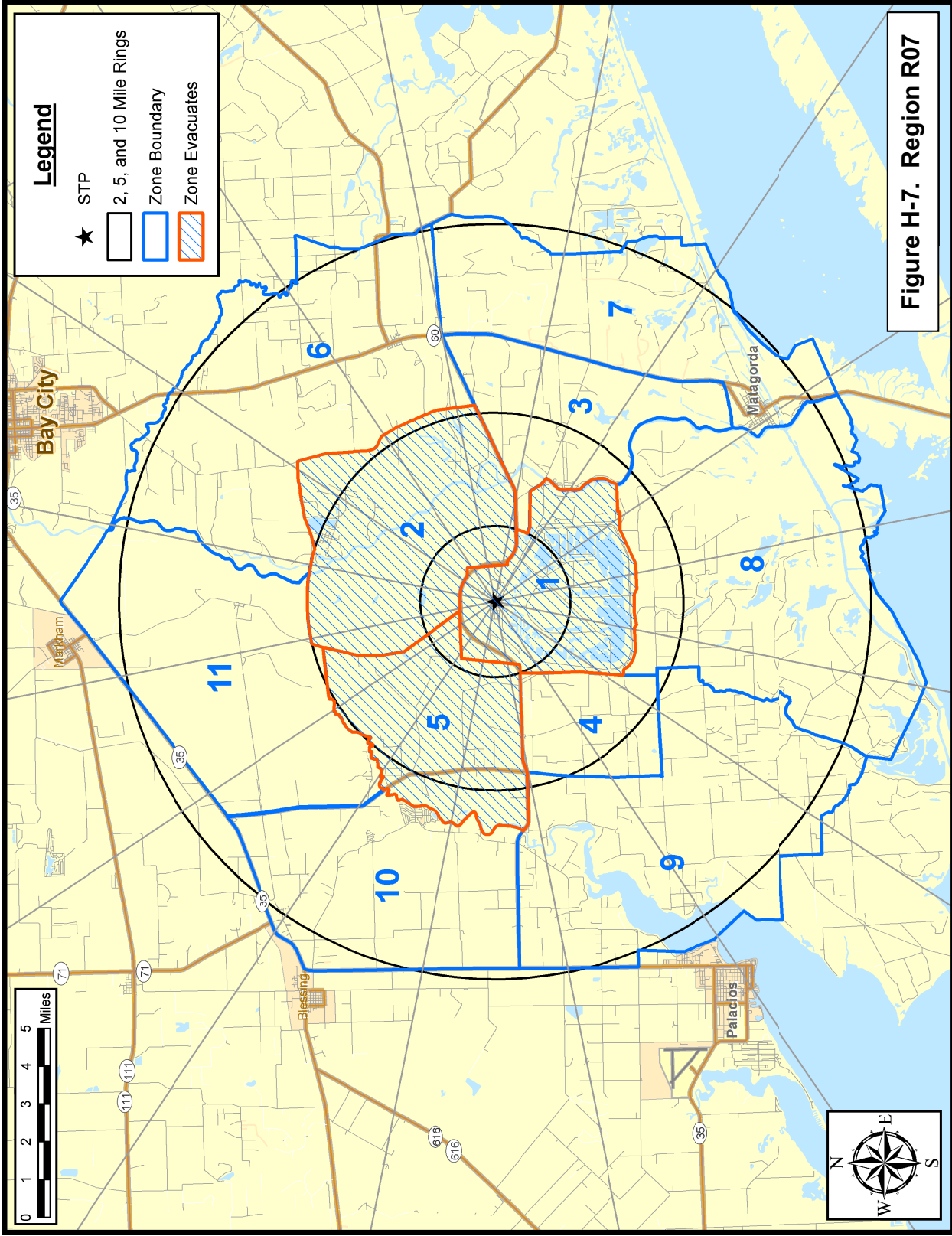
Figure H-3. Region R03





**Figure H-5. Region R05**





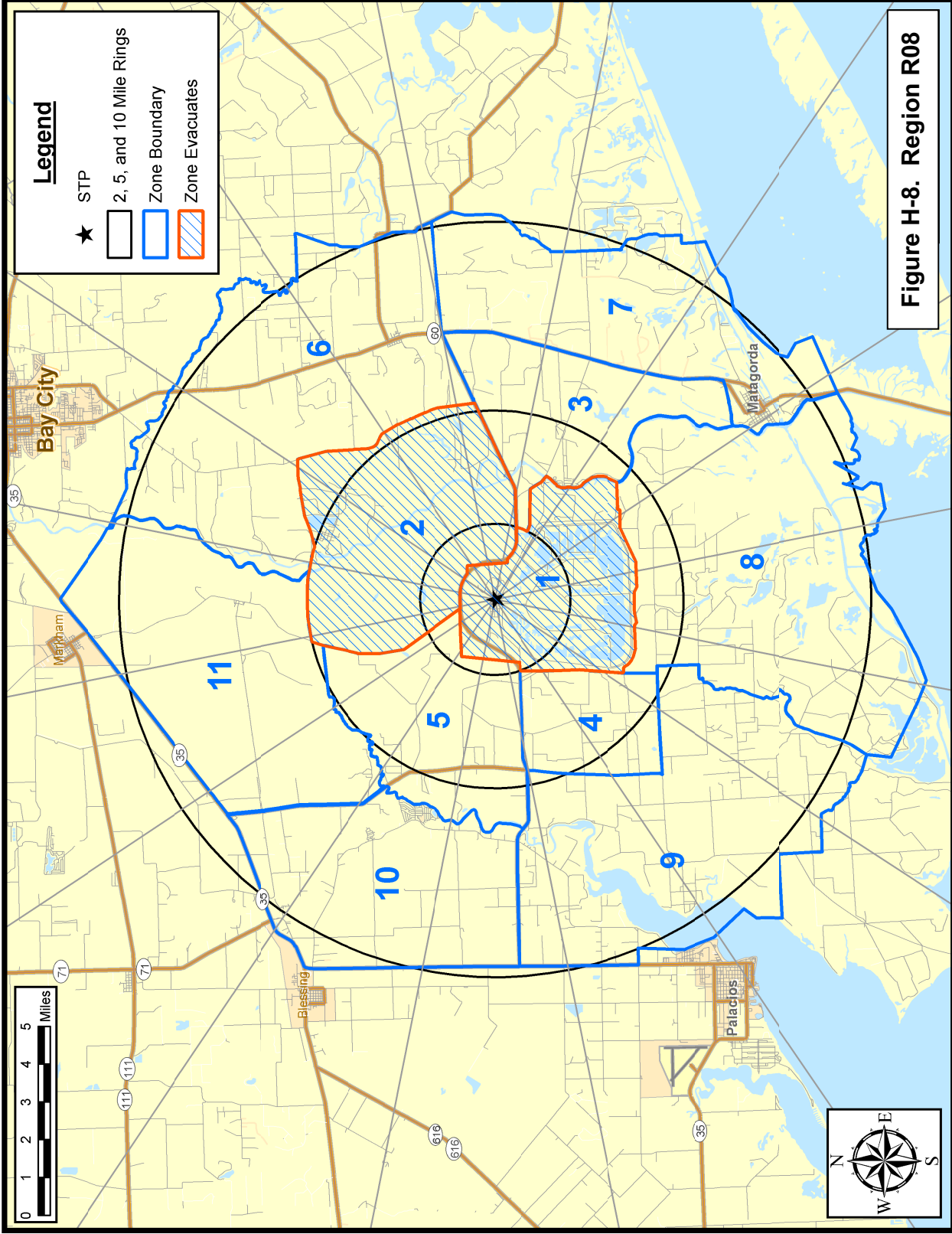
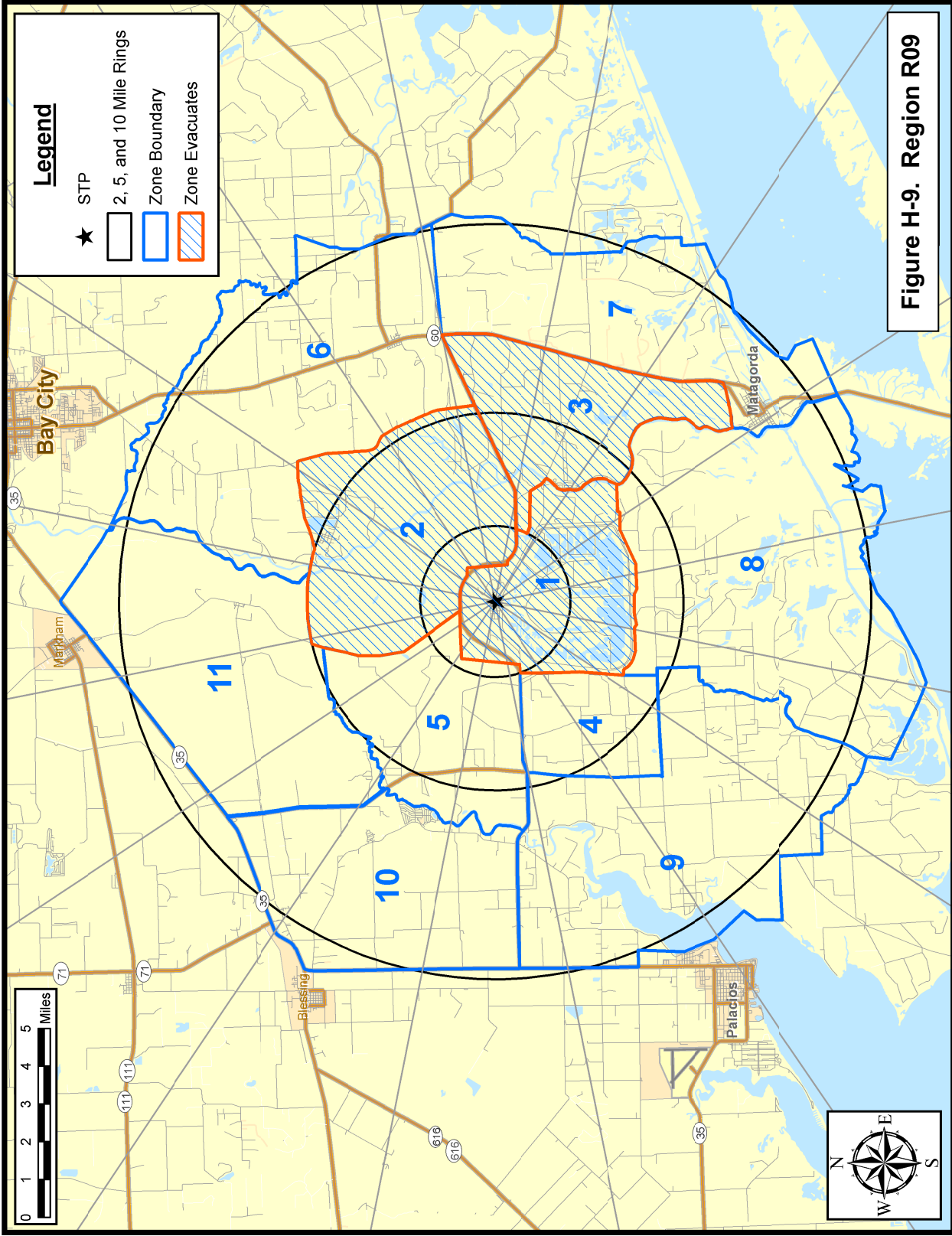
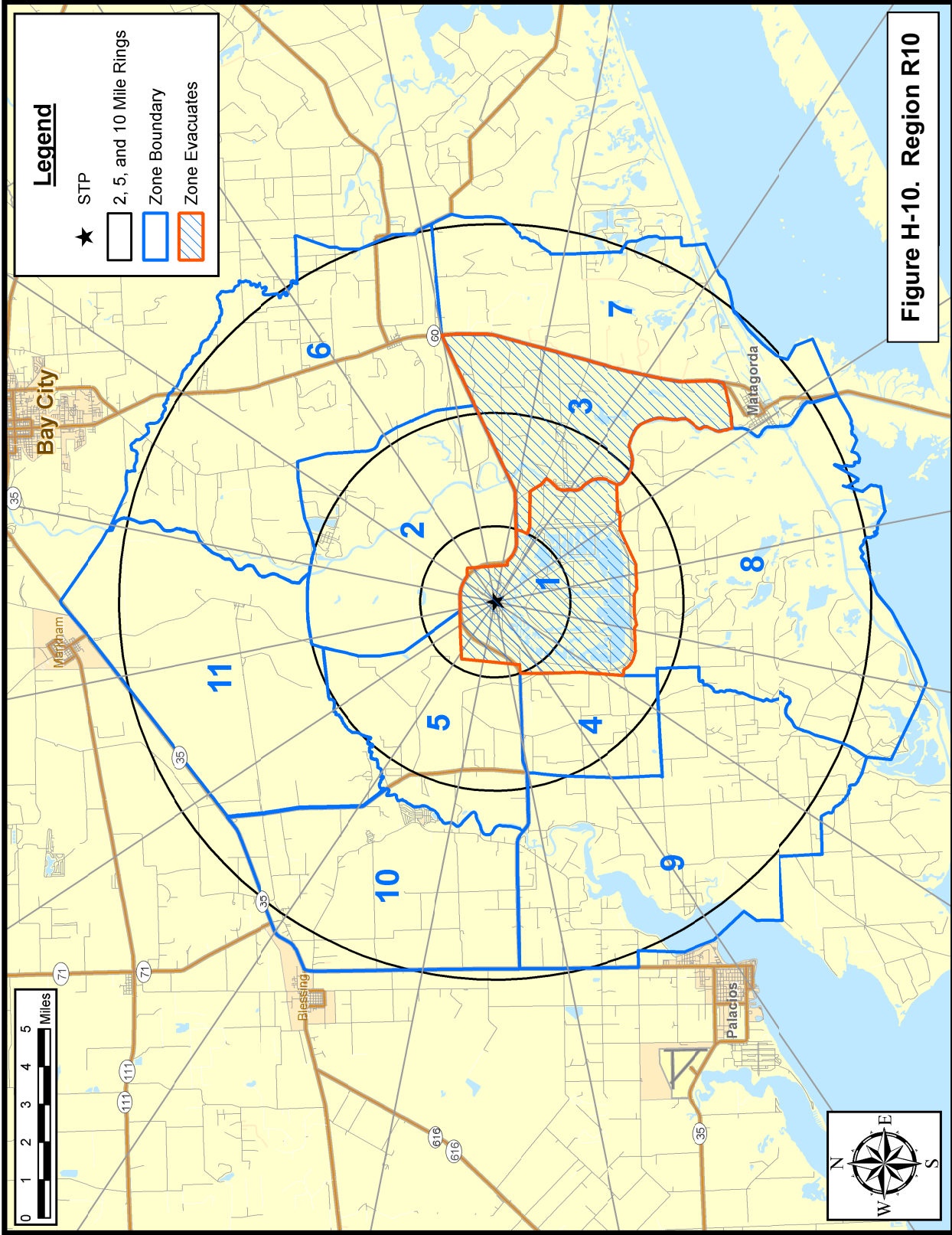


Figure H-8. Region R08







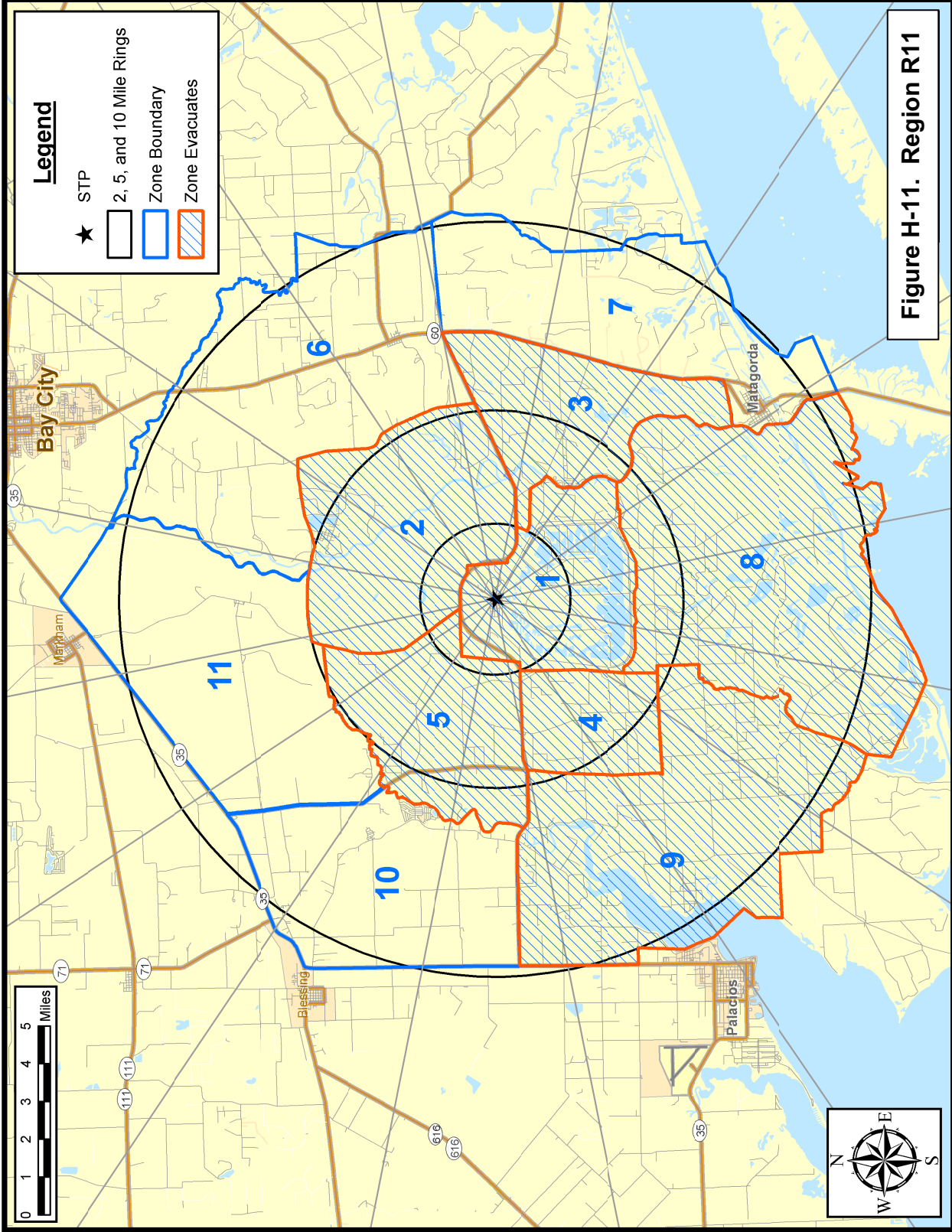


Figure H-11. Region R11

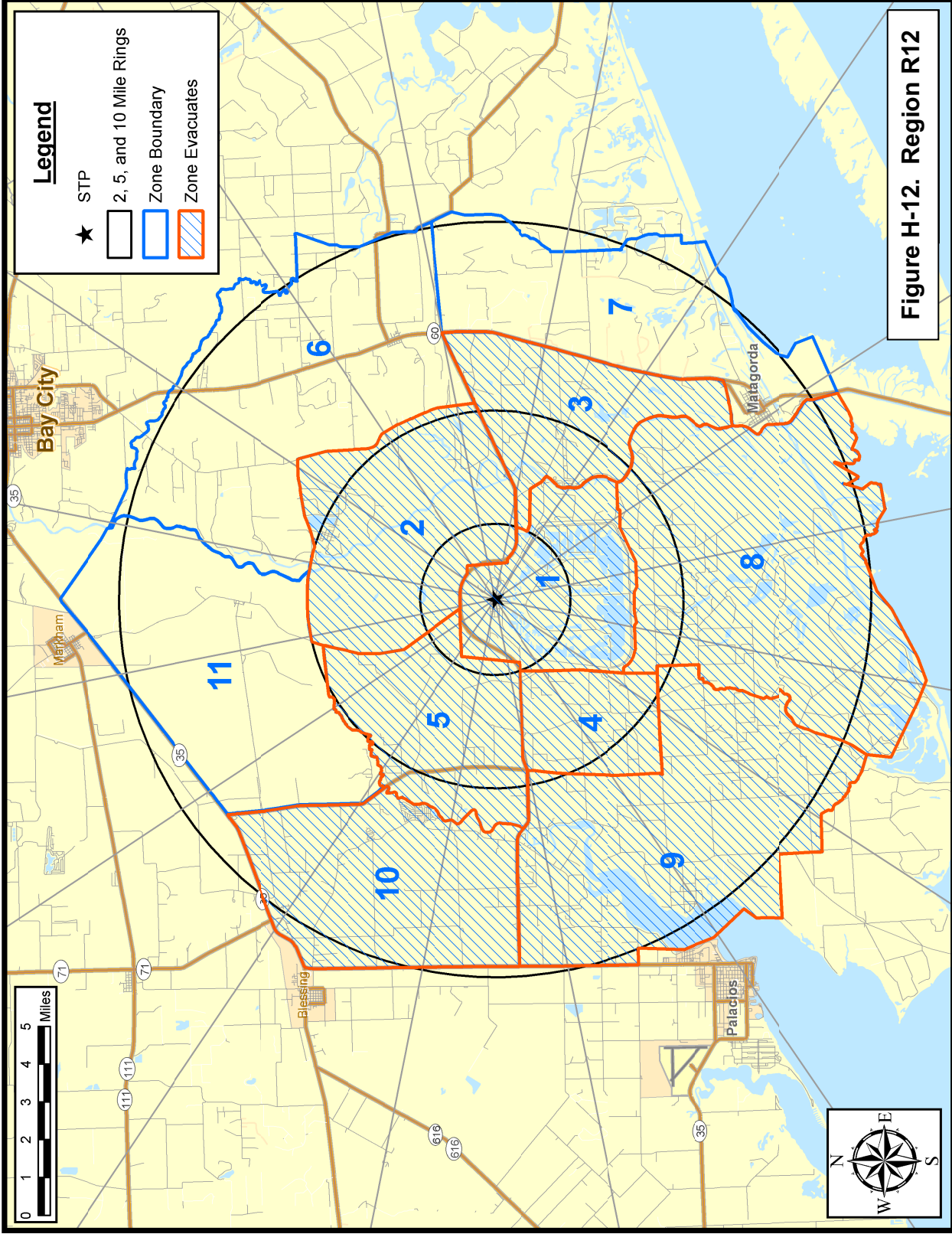
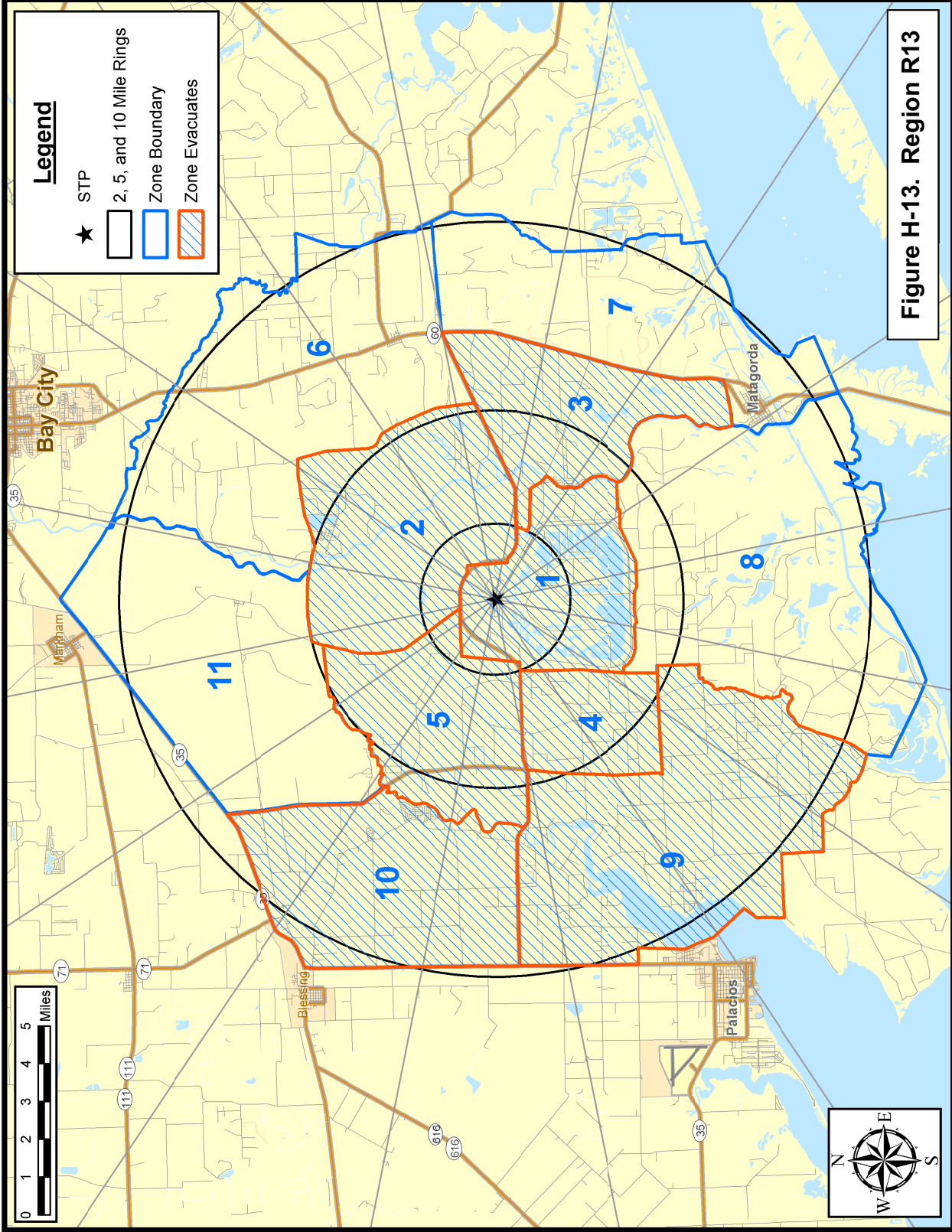
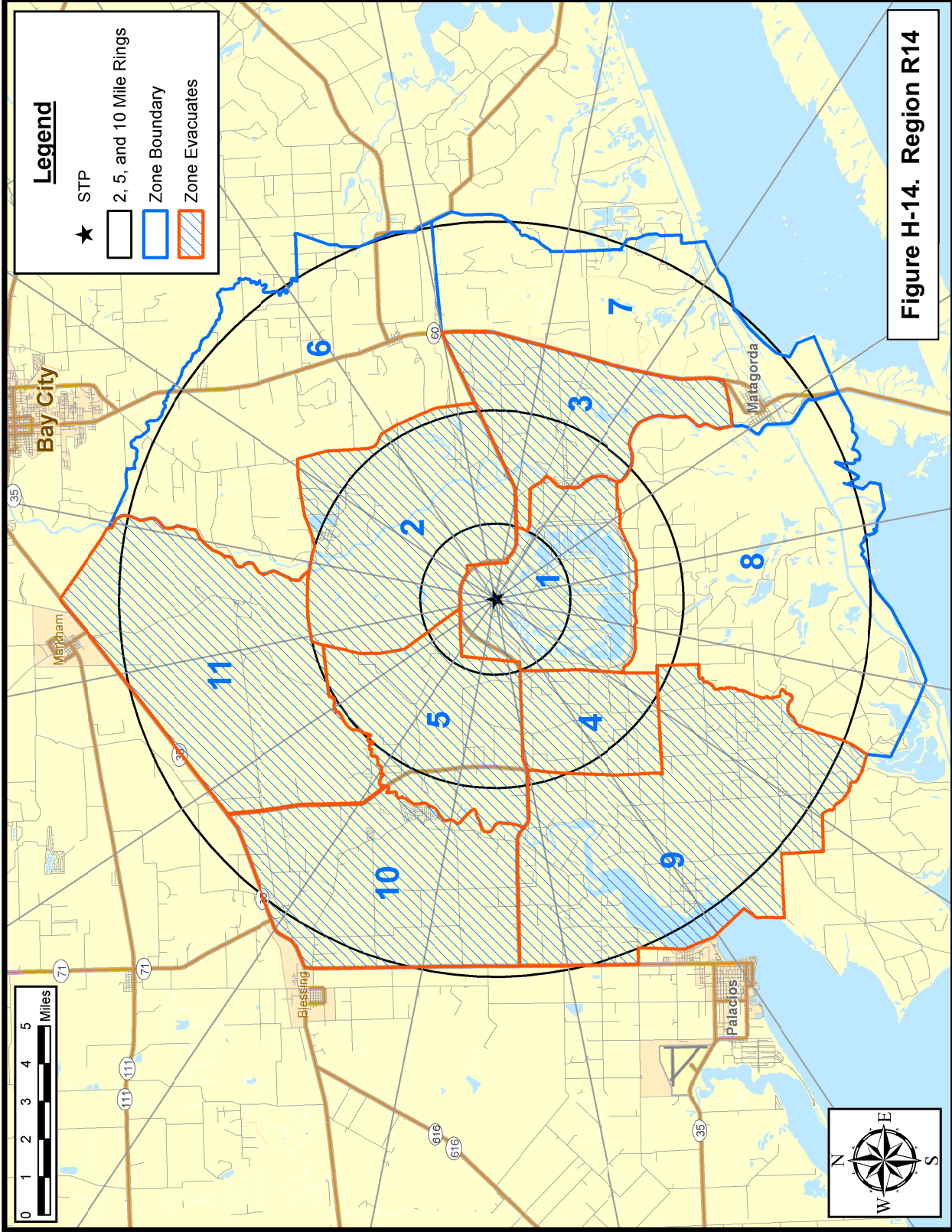
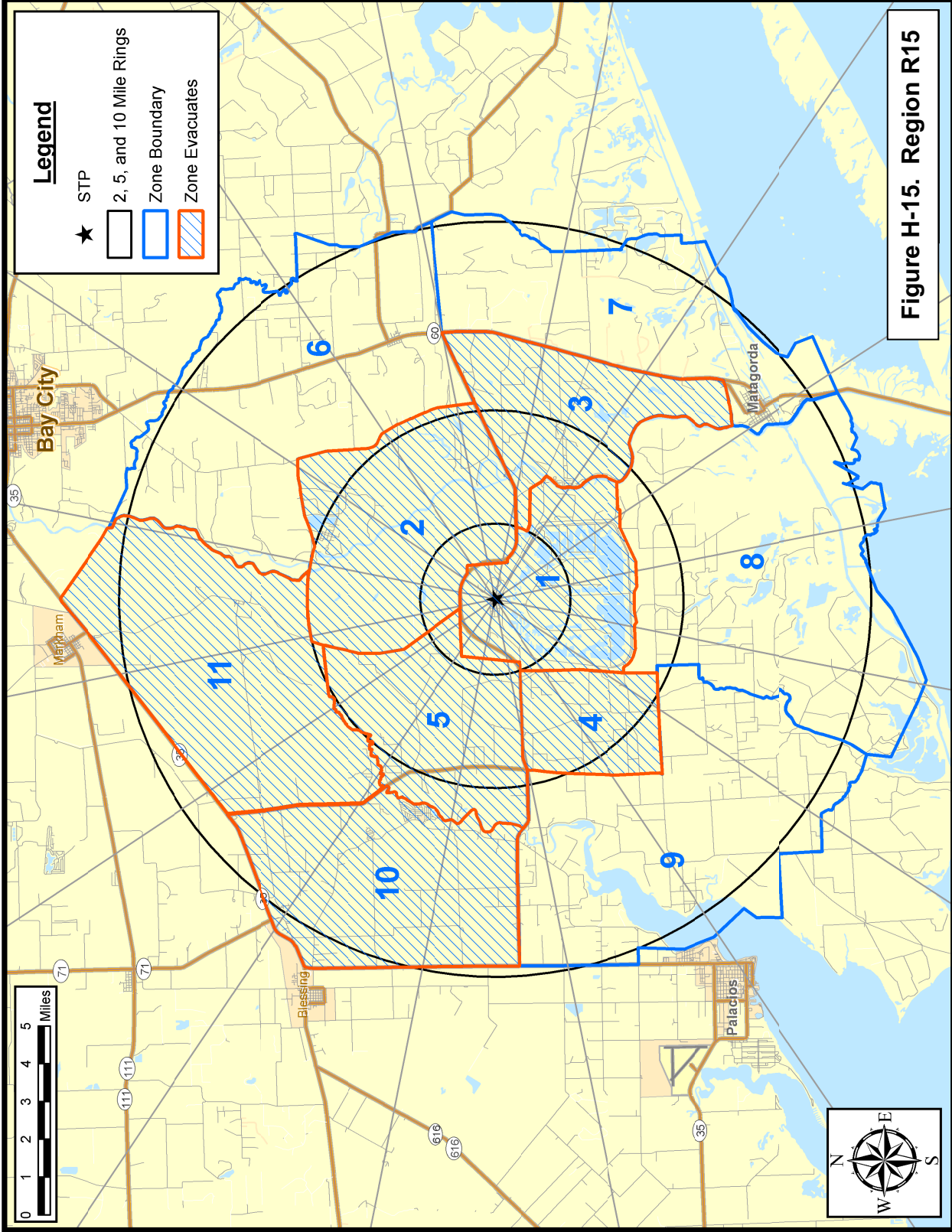
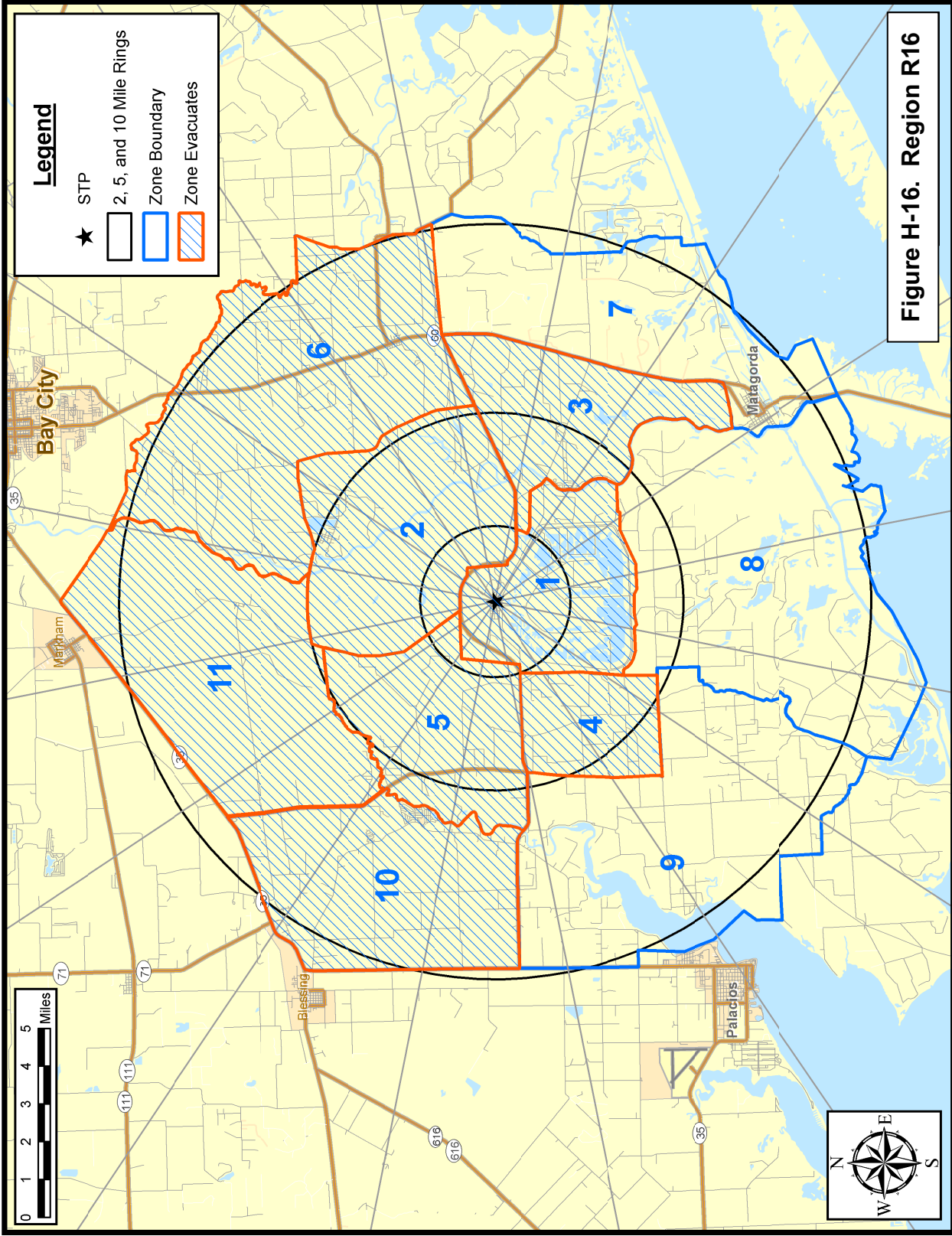


Figure H-12. Region R12











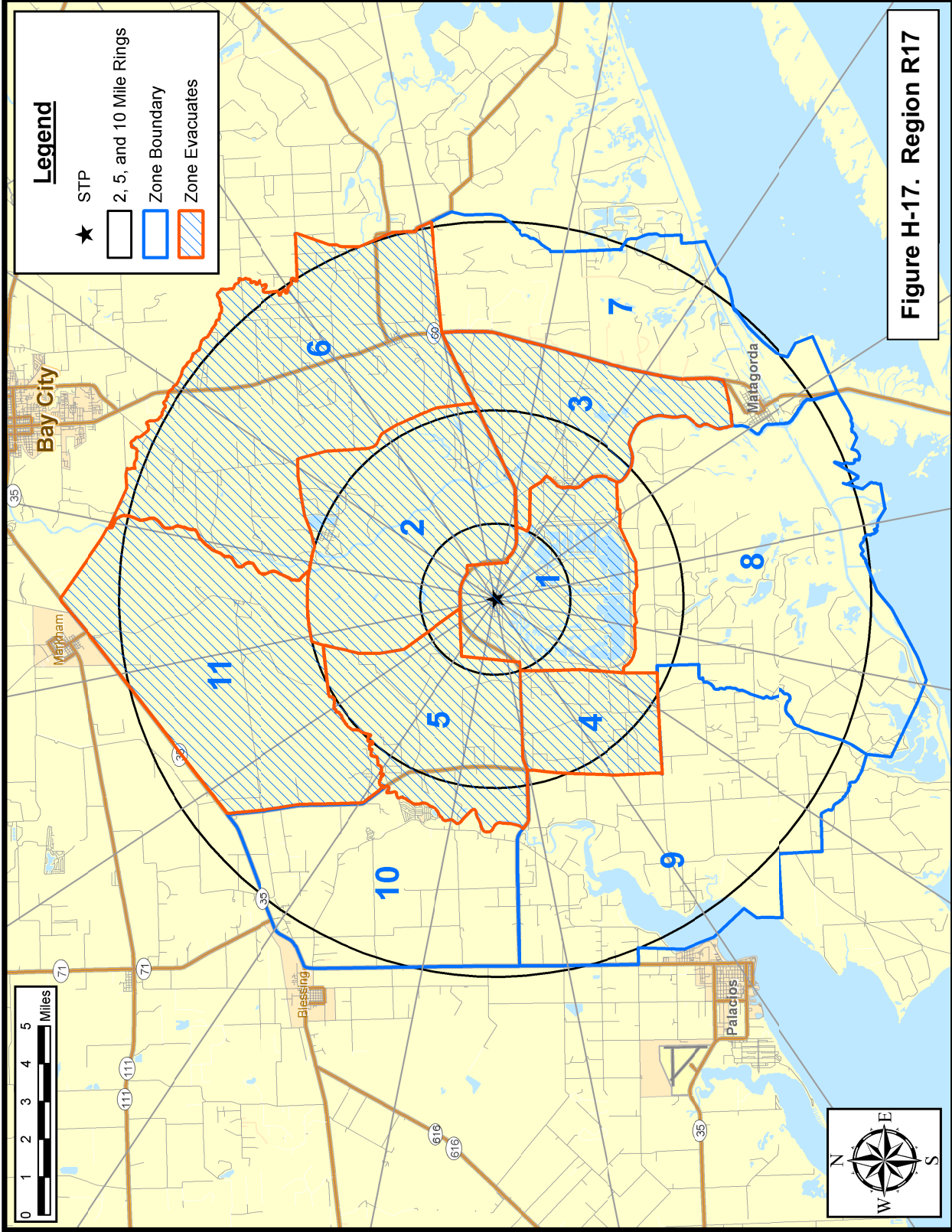


Figure H-17. Region R17

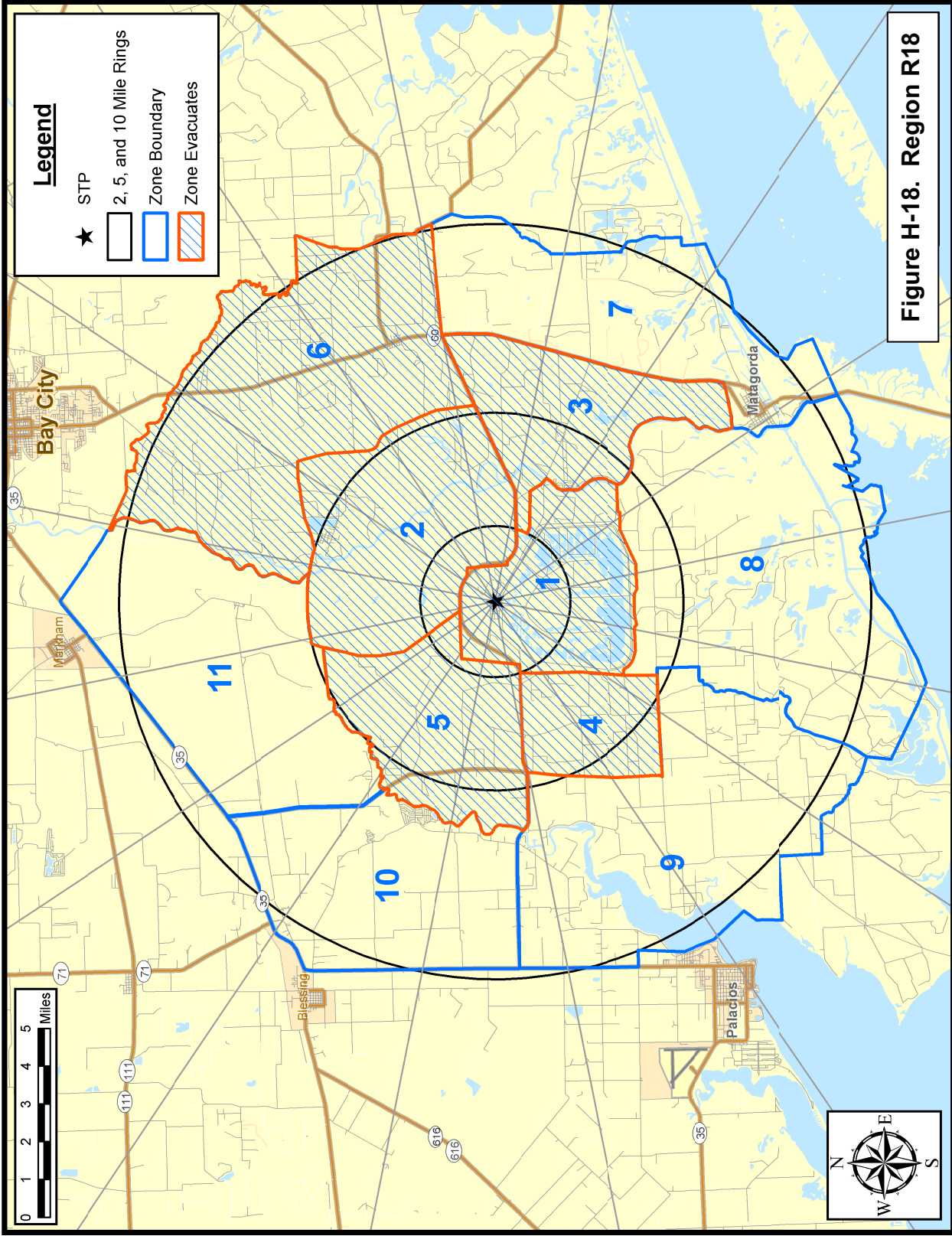
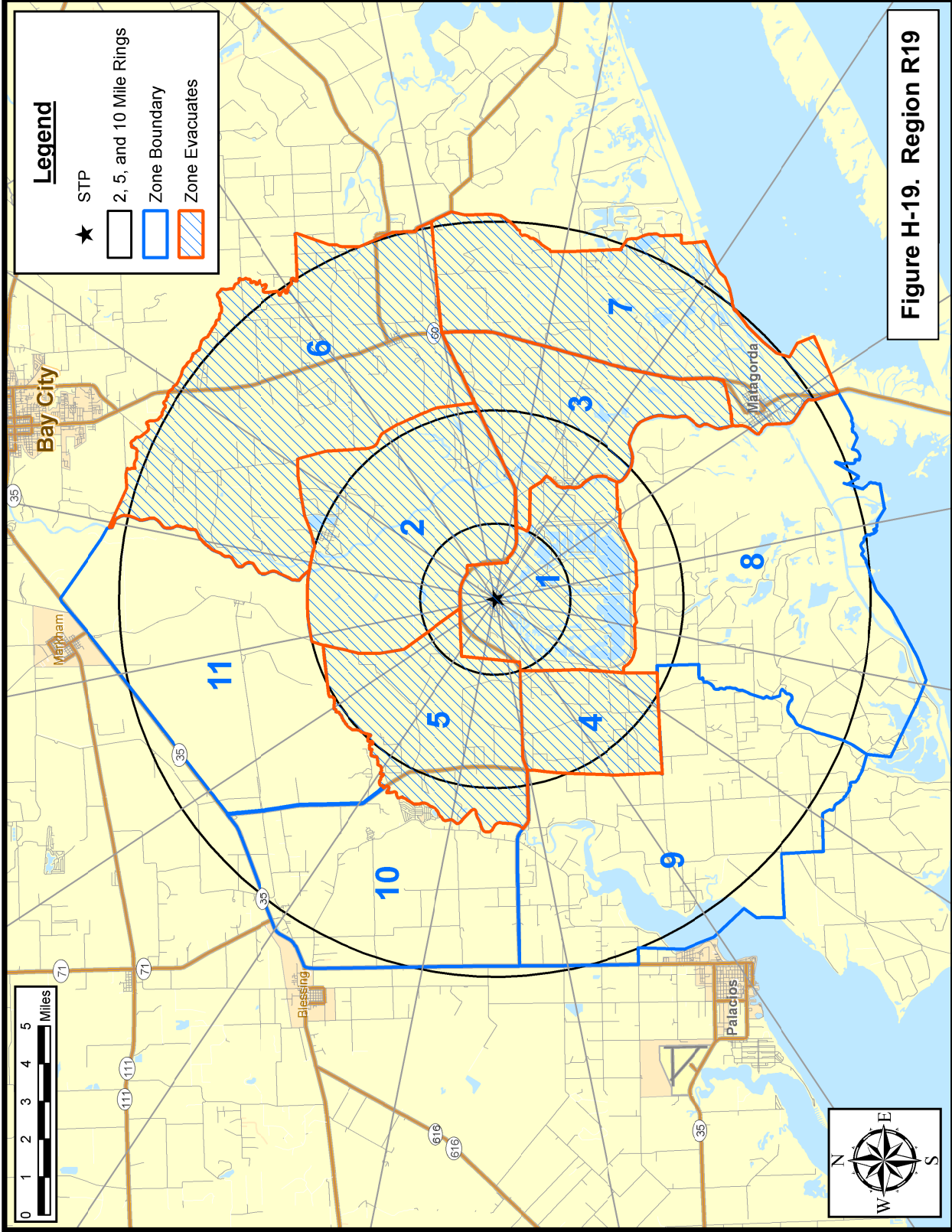
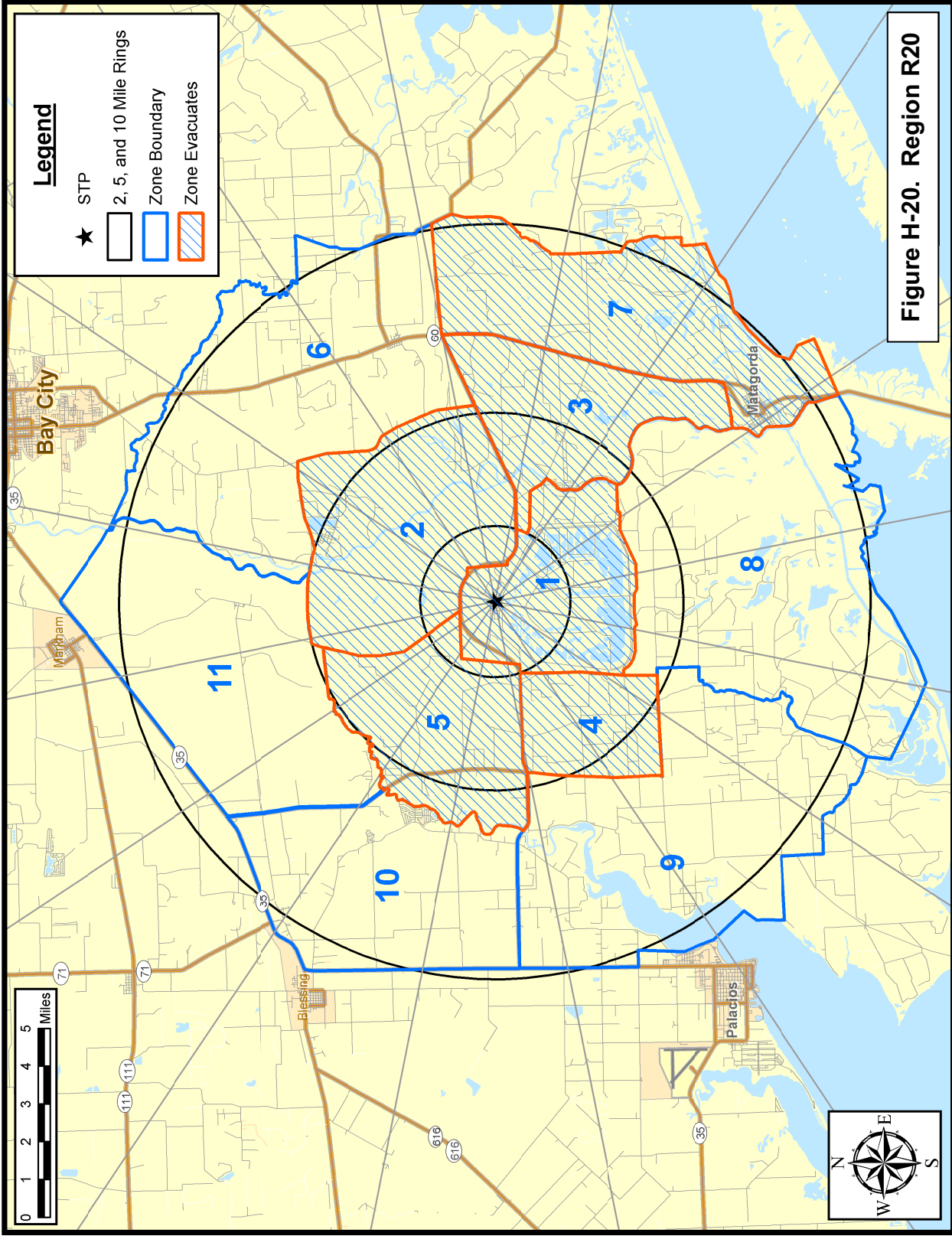
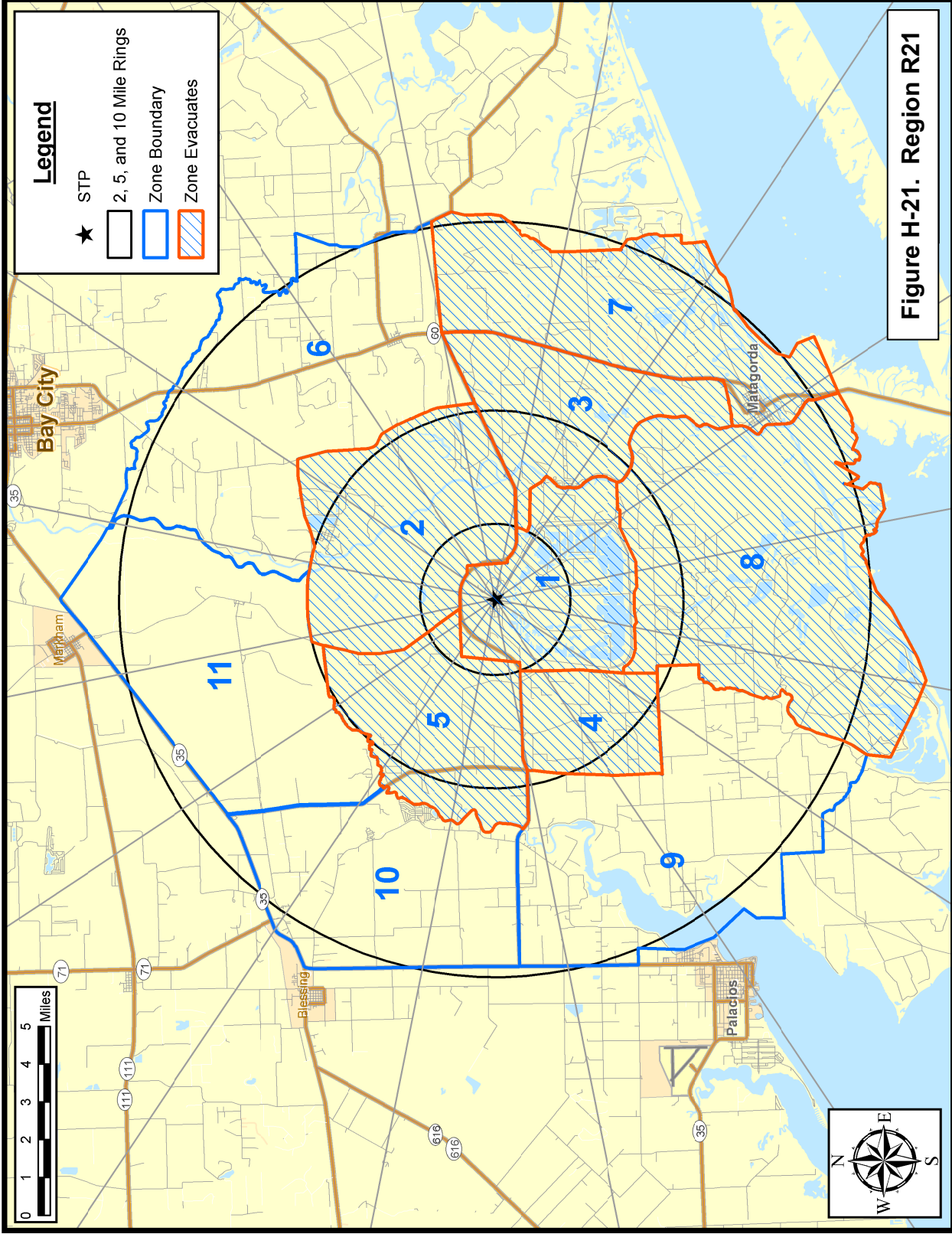
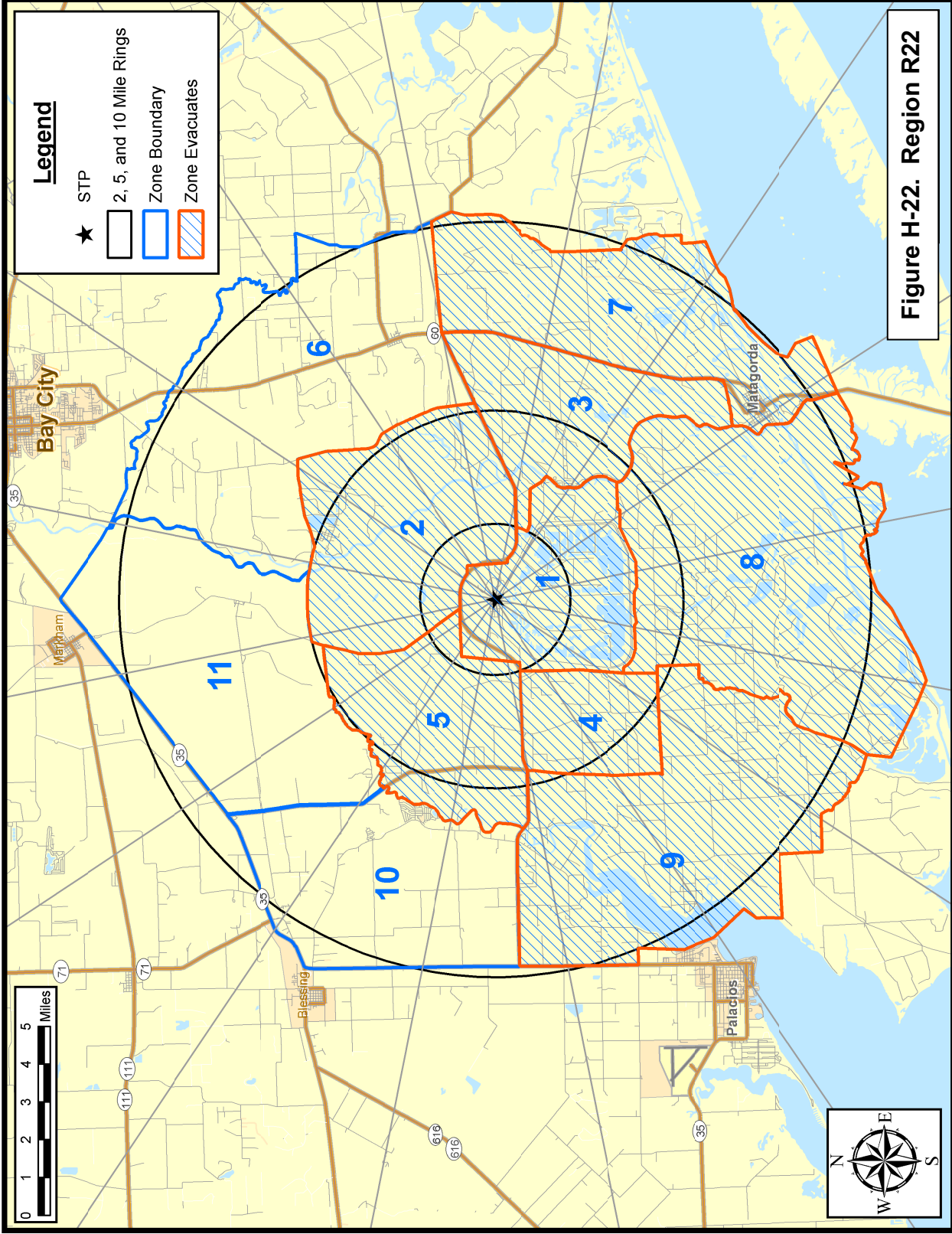


Figure H-18. Region R18









APPENDIX I

Evacuation Sensitivity Studies

## APPENDIX I: EVACUATION SENSITIVITY STUDIES

A sensitivity study was performed to determine whether changes in the estimated trip generation time have an effect upon the Evacuation Time Estimates (ETE) for the entire EPZ. The case considered was Scenario 1, Region 3; a summer, midweek, midday, good weather evacuation of the entire EPZ. Table I-1 presents the results of this study.

<b>Table I-1. Evacuation Time Estimates for Trip Generation Sensitivity Study</b>			
	<b>Evacuation Time Estimate</b>		
<b>Trip Generation Period</b>	<b>2-Mile Region</b>	<b>5-Mile Region</b>	<b>Entire EPZ</b>
3 Hours	1:00	3:10	3:10
6 Hours (Base)	1:00	6:00	6:10

As the mobilization time is reduced, the ETE for 2-mile, 5-mile, and the full EPZ reduce accordingly. The results confirm the importance of accurately estimating trip generation times. The evacuation time estimates closely mirror the values for the time the last evacuation trip is generated. The reason for this is the lack of significant traffic congestion during an evacuation. The results indicate that programs to educate the public to encourage faster responses to a radiological emergency, can considerably reduce ETE.



A sensitivity study was also conducted to determine the effects on ETE of changes in the percentage of people who decide to relocate from the Shadow Region. The movement of people in the shadow region has the potential to impede vehicles evacuating from an Evacuation Region within the EPZ. The case considered was Scenario 3, Region 3; a summer, weekend, midday, good weather evacuation of the entire EPZ. Refer to Section 7.1 for additional information on population within the shadow region.

Table I-2 presents the evacuation time estimates for each of these cases. The ETE for the 2-mile, 5-mile and Entire EPZ regions remain unchanged as the percentage of people who decide to relocate from areas within the Shadow Region increases from 15% to 60%. These results indicate that the ETE are not impacted by the “shadow effect” and further illustrates that the ETE are dictated by the mobilization time of the evacuating populous.

<b>Table I-2. Evacuation Time Estimates for Shadow Sensitivity Study</b>					
<b>Percent Shadow Evacuation</b>	<b>Evacuating Shadow Population</b>	<b>Evacuating Shadow Vehicles</b>	<b>Evacuation Time Estimate</b>		
			<b>2-Mile Region</b>	<b>5-Mile Region</b>	<b>Entire EPZ</b>
15	4,142	2,488	1:00	5:10	5:50
30 (Base)	8,284	4,976	1:00	5:10	5:50
60	16,568	9,951	1:00	5:10	5:50

APPENDIX J

Evacuation Time Estimates for All Evacuation Regions and Scenarios  
And  
Evacuation Time Graphs for Region R03, for all Scenarios

APPENDIX J: EVACUATION TIME ESTIMATES FOR  
ALL EVACUATION REGIONS AND SCENARIOS

AND

EVACUATION TIME GRAPHS FOR REGION R03, FOR ALL SCENARIOS

This appendix presents the ETE Results for all 22 Regions and all 12 Scenarios (Tables J-1A through J-1D).

Plots of Evacuating vehicles vs. Elapsed Time leaving the 2-mile and 5-mile circular areas around STP, and the entire EPZ (Region R03), for all 12 scenarios are presented (Figures J-1 through J-12). Each plot has points indicating the evacuation times corresponding to the 50<sup>th</sup>, 90<sup>th</sup>, and 95<sup>th</sup> percentiles of evacuated vehicles.

J.1 Guidance on Using ETE Tables

Tables J-1A through J-1D present the ETE values for all 22 Evacuation Regions and all 12 Evacuation Scenarios. They are organized as follows:

Table	Contents
J-1A	ETE represents the elapsed time required for 50 percent of the vehicles within a Region, to evacuate from that Region.
J-1B	ETE represents the elapsed time required for 90 percent of the vehicles within a Region, to evacuate from that Region.
J-1C	ETE represents the elapsed time required for 95 percent of the vehicles within a Region, to evacuate from that Region.
J-1D	ETE represents the elapsed time required for 100 percent of the vehicles within a Region, to evacuate from that Region.

The user first determines the percentile of vehicles for which the ETE is sought. The applicable value of ETE within the chosen Table may then be identified using the following procedure:

1. Identify the applicable **Scenario**:
  - The Season
    - Summer
    - Winter (also Autumn and Spring)

- The Day of Week
  - Midweek
  - Weekend
- The Time of Day
  - Midday
  - Evening
- Weather Condition
  - Good Weather
  - Rain
- Special Event
  - Holiday Beach Weekend
  - New Plant Construction

While these Scenarios are designed, in aggregate, to represent conditions throughout the year, some further clarification is warranted:

- The conditions of a summer evening (either midweek or weekend) and rain are not explicitly identified in Tables J-1A through J-1D. For these conditions, Scenario (4) applies.
- The conditions of a winter evening (either midweek or weekend) and rain are not explicitly identified in Tables J-1A through J-1D. For these conditions, Scenario (9) applies.
- The seasons are defined as follows:
  - Summer implies that public schools are *not* in session.
  - Winter, Spring, and Autumn imply that public schools *are* in session.
- Time of Day: Midday implies the time over which most commuters are at work.

2. With the Scenario identified, now identify the **Evacuation Region**:

- Determine the projected azimuth direction of the plume, as dictated by the wind direction. The wind direction is expressed in degrees, clockwise from North and represents the direction *from which* the wind originates.
- Determine the distance that the Evacuation Region will extend from the South Texas Project. The applicable distances and their associated candidate Regions are given below:
  - 2 Miles (Region R01)
  - 5 Miles (Regions R02 and R04 through R10)
  - To EPZ Boundary (Regions R03 and R11 through R22)
- Enter Table 7-2 and identify the applicable group of candidate Regions based on the distance that the selected Region extends from STP. Select the Evacuation Region identifier in that row from the first column of the Table

3. Determine the **ETE for the Scenario** identified in Step 1 and the Region identified in Step 2, as follows:
  - The columns of Table J-1 are labeled with the Scenario numbers. Identify the proper column in the selected Table using the Scenario number determined in Step 1.
  - Identify the row in this table that provides ETE values for the Region identified in Step 2.
  - The unique data cell defined by the column and row so determined contains the desired value of ETE expressed in Hours:Minutes.

### Example

It is desired to identify the ETE for the following conditions:

- Sunday, August 10<sup>th</sup> at 4:00 AM.
- The weather is good.
- Wind direction is from 300°.
- Wind speed is such that the distance to be evacuated is judged to be 10 miles (to EPZ boundary).
- The desired ETE is that value needed to evacuate 95 percent of the population from within the impacted Region.

Table J-1C is applicable because the 95<sup>th</sup>-percentile population is desired. Proceed as follows:

1. Identify the Scenario as summer, weekend, evening and good weather. Entering Table J-1C these descriptors identify this combination of circumstances as being Scenario 5.
2. Enter Table J-1C and locate the group entitled “Evacuate 5-Mile Ring and Downwind to EPZ Boundary”. Under “Wind Direction”, identify the 299° to 343° azimuth and read REGION R21 in the first column of that row.
3. Enter Table J-1C to locate the data cell containing the value of ETE for Scenario 5 and Region R21. This data cell is in column (5) and in the row for Region R21; it contains the ETE value of **3:30**.

Table J-1A. Time To Clear The Indicated Area of 50 Percent of the Affected Population

Scenario: Region Wind From:	Summer			Winter			Midweek			Summer			
	Midweek		Midday	Midweek		Midday	Midweek		Midweek		Midweek		
	(1)	(2)	(3)	(4)	(5)	(6)	(7)	(8)	(9)	(10)	Scenario:	Region Wind From:	
R01 2-mile ring	0:40	0:40	0:40	0:40	0:40	0:40	0:40	0:40	0:40	0:40	R01 2-mile ring	0:40	0:50
R02 5-mile ring	0:55	1:05	1:05	1:05	1:05	0:55	0:55	1:05	1:05	1:10	R02 5-mile ring	1:45	1:00
R03 Entire EPZ	1:10	1:10	1:15	1:20	1:10	1:10	1:10	1:15	1:20	1:25	R03 Entire EPZ	1:35	1:15
Entire 2-Mile Region, 5-Mile Region, and EPZ													
2-Mile Ring and Downwind to 5 Miles													
R04 29° to 50°	0:40	0:45	0:45	0:45	0:45	0:40	0:45	0:45	0:45	0:45	R04 29° to 50°	0:45	0:50
R05 51° to 106°	0:45	0:45	0:50	0:50	0:50	0:45	0:45	0:50	0:50	0:50	R05 51° to 106°	0:50	0:55
R06 107° to 140°	0:45	0:45	0:45	0:50	0:45	0:45	0:45	0:45	0:50	0:45	R06 107° to 140°	0:45	0:55
R07 141° to 174°	0:50	0:50	0:50	0:50	0:50	0:50	0:50	0:50	0:50	0:50	R07 141° to 174°	0:50	0:55
R08 175° to 230°	0:45	0:45	0:45	0:45	0:45	0:45	0:45	0:45	0:45	0:45	R08 175° to 230°	0:45	0:55
R09 231° to 286°	0:50	0:55	1:00	1:05	1:00	0:50	0:50	1:00	1:05	1:05	R09 231° to 286°	1:45	1:00
R10 287° to 331°	0:50	0:50	1:00	1:05	1:00	0:50	0:50	1:00	1:05	1:05	R10 287° to 331°	1:45	0:55
R01 332° to 28°	0:40	0:40	0:40	0:40	0:40	0:40	0:40	0:40	0:40	0:40	R01 332° to 28°	0:40	0:50
5-Mile Ring and Downwind to EPZ Boundary													
R11 355° to 50°	1:00	1:00	1:05	1:05	1:05	1:00	1:00	1:10	1:10	1:15	R11 355° to 50°	1:25	1:05
R12 51° to 61°	1:00	1:00	1:05	1:05	1:05	1:00	1:00	1:10	1:10	1:15	R12 51° to 61°	1:25	1:05
R13 62° to 95°	1:00	1:00	1:05	1:05	1:05	1:00	1:00	1:10	1:10	1:15	R13 62° to 95°	1:25	1:05
R14 96° to 129°	1:00	1:00	1:05	1:05	1:05	1:00	1:00	1:10	1:10	1:20	R14 96° to 129°	1:25	1:05
R15 130° to 163°	1:00	1:00	1:05	1:05	1:05	1:00	1:00	1:05	1:05	1:15	R15 130° to 163°	1:25	1:05
R16 164° to 174°	1:05	1:10	1:10	1:15	1:10	1:05	1:05	1:15	1:20	1:20	R16 164° to 174°	1:30	1:15
R17 175° to 219°	1:05	1:10	1:10	1:15	1:10	1:05	1:05	1:15	1:20	1:20	R17 175° to 219°	1:50	1:15
R18 220° to 230°	1:05	1:05	1:10	1:15	1:10	1:05	1:05	1:15	1:15	1:20	R18 220° to 230°	1:50	1:10
R19 231° to 286°	1:05	1:10	1:15	1:20	1:10	1:05	1:05	1:15	1:15	1:20	R19 231° to 286°	2:00	1:15
R20 287° to 298°	0:55	0:55	1:05	1:10	1:05	0:55	0:55	1:05	1:10	1:10	R20 287° to 298°	1:50	1:00
R21 299° to 343°	0:55	0:55	1:05	1:10	1:05	0:55	0:55	1:05	1:10	1:10	R21 299° to 343°	1:50	1:00
R22 344° to 354°	1:00	1:05	1:10	1:15	1:05	1:00	1:00	1:15	1:15	1:20	R22 344° to 354°	1:50	1:05

Table J-1B: Time To Clear The Indicated Area of 90 Percent of the Affected Population

Scenario: Region Wind From:	Summer			Winter			Winter			Summer				
	Midweek (1)	Midday (2)	Weekend (3)	Midweek (4)	Midday (5)	Weekend (6)	Midweek (7)	Midday (8)	Weekend (9)	Evening (10)	Scenario: Region Wind From:	Midweek Holiday	Midday Beach Holiday	Summer New Plant Construction
Entire 2-Mile Region, 5-Mile Region, and EPZ														
R01 2-mile ring	0:55	0:55	0:50	0:50	0:50	0:55	0:55	0:50	0:50	0:50	R01 2-mile ring	0:50	0:50	1:20
R02 5-mile ring	2:10	2:20	2:10	2:10	2:30	2:30	2:40	2:50	2:50	3:00	R02 5-mile ring	3:10	3:10	1:50
R03 Entire EPZ	3:00	3:00	2:40	2:40	2:50	3:30	3:30	3:20	3:20	3:40	R03 Entire EPZ	3:30	3:30	3:00
2-Mile Ring and Downwind to 5 Miles														
R04 29° to 50°	0:55	1:00	1:40	1:40	1:40	1:00	1:00	1:50	1:50	1:50	R04 29° to 50°	1:40	1:40	1:25
R05 51° to 106°	1:00	1:00	2:30	2:30	2:30	1:05	1:05	2:30	2:30	2:30	R05 51° to 106°	2:30	2:30	1:30
R06 107° to 140°	1:00	1:00	2:00	2:00	2:00	1:00	1:00	2:00	2:00	2:00	R06 107° to 140°	2:00	2:00	1:30
R07 141° to 174°	1:05	1:05	2:10	2:10	2:10	1:05	1:05	2:10	2:10	2:10	R07 141° to 174°	2:10	2:10	1:30
R08 175° to 230°	0:55	1:00	1:00	1:00	1:00	1:00	1:00	1:00	1:00	1:00	R08 175° to 230°	1:00	1:00	1:30
R09 231° to 286°	2:10	2:10	2:00	2:00	2:10	2:20	2:20	2:40	2:40	2:50	R09 231° to 286°	3:10	3:10	1:40
R10 287° to 331°	2:00	2:10	2:00	2:00	2:10	2:20	2:20	2:40	2:40	2:50	R10 287° to 331°	3:10	3:10	1:40
R01 332° to 28°	0:55	0:55	0:50	0:50	0:50	0:55	0:55	0:50	0:50	0:50	R01 332° to 28°	0:50	0:50	1:20
5-Mile Ring and Downwind to EPZ Boundary														
R11 355° to 50°	2:50	2:50	2:40	2:40	2:50	3:10	3:10	3:30	3:30	3:40	R11 355° to 50°	3:15	3:15	2:00
R12 51° to 61°	2:40	2:40	2:20	2:20	2:40	3:10	3:10	3:10	3:10	3:30	R12 51° to 61°	3:10	3:10	2:10
R13 62° to 95°	2:40	2:40	2:20	2:20	2:40	3:10	3:10	3:10	3:10	3:30	R13 62° to 95°	3:10	3:10	2:10
R14 96° to 129°	2:50	2:50	2:20	2:20	2:40	3:20	3:20	3:10	3:10	3:30	R14 96° to 129°	3:10	3:10	2:10
R15 130° to 163°	2:30	2:30	2:10	2:10	2:30	3:00	3:00	2:50	2:50	3:10	R15 130° to 163°	3:10	3:10	2:00
R16 164° to 174°	2:50	2:50	2:20	2:20	2:40	3:20	3:20	3:10	3:10	3:20	R16 164° to 174°	3:10	3:10	3:00
R17 175° to 219°	3:00	3:00	2:40	2:40	2:50	3:20	3:20	3:20	3:20	3:30	R17 175° to 219°	3:20	3:20	3:00
R18 220° to 230°	2:50	2:50	2:40	2:40	2:50	3:10	3:10	3:20	3:20	3:30	R18 220° to 230°	3:20	3:20	3:00
R19 231° to 286°	2:50	2:50	2:40	2:40	2:50	3:10	3:10	3:20	3:20	3:30	R19 231° to 286°	3:30	3:30	3:00
R20 287° to 298°	2:20	2:20	2:10	2:10	2:30	2:50	2:50	2:50	2:50	3:10	R20 287° to 298°	3:25	3:25	1:50
R21 299° to 343°	2:20	2:20	2:10	2:10	2:30	2:50	2:50	2:50	2:50	3:10	R21 299° to 343°	3:25	3:25	1:50
R22 344° to 354°	2:40	2:40	2:30	2:30	2:50	3:10	3:10	3:20	3:20	3:40	R22 344° to 354°	3:25	3:25	2:00

Table J-1C: Time To Clear The Indicated Area of 95 Percent of the Affected Population

Scenario: Region Wind From:	Summer			Winter			Winter			Summer		
	Midweek		Midday	Midweek		Midday	Weekend		Midday	Holiday		Midweek
	(1)	(2)	(3)	(4)	(5)	(6)	(7)	(8)	(9)	(10)	(11)	(12)
Scenario: Region Wind From:	Scenario: Region Wind From:	Scenario: Region Wind From:	Scenario: Region Wind From:	Scenario: Region Wind From:	Scenario: Region Wind From:	Scenario: Region Wind From:	Scenario: Region Wind From:	Scenario: Region Wind From:	Scenario: Region Wind From:	Scenario: Region Wind From:	Scenario: Region Wind From:	Scenario: Region Wind From:
Entire 2-Mile Region, 5-Mile Region, and EPZ												
R01 2-mile ring	0:55	0:55	0:50	0:50	0:50	0:55	0:55	0:50	0:50	0:50	0:50	R01 2-mile ring
R02 5-mile ring	3:10	3:20	3:00	3:00	3:20	3:40	3:40	3:50	3:50	4:10	4:10	R02 5-mile ring
R03 Entire EPZ	4:00	4:00	3:40	3:40	4:00	4:20	4:20	4:10	4:20	4:20	4:20	R03 Entire EPZ
2-Mile Ring and Downwind to 5 Miles												
R04 29° to 50°	1:00	1:00	2:30	2:30	2:50	1:00	1:00	2:50	2:50	2:50	2:30	R04 29° to 50°
R05 51° to 106°	1:50	1:50	3:25	3:25	3:30	1:50	1:50	3:40	3:40	3:40	3:25	R05 51° to 106°
R06 107° to 140°	1:30	1:30	2:50	2:50	2:40	1:30	1:30	2:50	2:50	2:50	2:50	R06 107° to 140°
R07 141° to 174°	1:50	1:50	2:50	2:50	2:40	1:50	1:50	2:50	2:50	2:50	2:50	R07 141° to 174°
R08 175° to 230°	1:00	1:00	1:30	1:30	1:30	1:00	1:00	1:30	1:30	1:30	1:30	R08 175° to 230°
R09 231° to 286°	3:00	3:00	2:50	2:50	3:00	3:30	3:30	3:40	3:40	4:00	3:25	R09 231° to 286°
R10 287° to 331°	3:00	3:00	2:50	2:50	3:00	3:30	3:30	3:40	3:40	4:00	3:25	R10 287° to 331°
R01 332° to 28°	0:55	0:55	0:50	0:50	0:50	0:55	0:55	0:50	0:50	0:50	0:50	R01 332° to 28°
5-Mile Ring and Downwind to EPZ Boundary												
R11 355° to 50°	3:50	3:50	3:40	3:40	3:50	4:10	4:10	4:10	4:10	4:20	3:25	R11 355° to 50°
R12 51° to 61°	3:40	3:40	3:20	3:20	3:50	4:10	4:10	4:10	4:10	4:20	3:25	R12 51° to 61°
R13 62° to 95°	3:40	3:40	3:20	3:20	3:50	4:10	4:10	4:10	4:10	4:20	3:25	R13 62° to 95°
R14 96° to 129°	3:50	3:50	3:30	3:30	3:50	4:10	4:10	4:10	4:10	4:20	3:25	R14 96° to 129°
R15 130° to 163°	3:30	3:30	3:00	3:00	3:30	4:00	4:00	4:00	4:00	4:10	3:25	R15 130° to 163°
R16 164° to 174°	3:50	3:50	3:20	3:20	3:50	4:10	4:10	4:10	4:10	4:20	3:30	R16 164° to 174°
R17 175° to 219°	4:00	4:00	3:40	3:40	4:00	4:10	4:10	4:10	4:10	4:20	3:35	R17 175° to 219°
R18 220° to 230°	3:50	3:50	3:40	3:40	4:00	4:10	4:10	4:10	4:10	4:20	3:35	R18 220° to 230°
R19 231° to 286°	3:50	3:50	3:40	3:40	3:50	4:10	4:10	4:10	4:10	4:20	3:50	R19 231° to 286°
R20 287° to 298°	3:20	3:20	3:00	3:00	3:30	3:50	3:50	4:00	4:00	4:10	3:40	R20 287° to 298°
R21 299° to 343°	3:20	3:20	3:00	3:00	3:30	3:50	3:50	4:00	4:00	4:10	3:40	R21 299° to 343°
R22 344° to 354°	3:50	3:50	3:40	3:40	3:50	4:10	4:10	4:10	4:10	4:20	3:40	R22 344° to 354°



Table J-1D. Time To Clear The Indicated Area of 100 Percent of the Affected Population

Scenario: Region Wind From:	Summer		Summer		Summer		Winter		Winter		Winter		Summer	
	Midweek	Midday	Weekend	Midweek	Midday	Weekend	Midweek	Midday	Weekend	Midweek	Midday	Weekend	Midweek	Midday
R01 2-mile ring	1:00	1:00	1:00	1:00	1:00	1:00	1:00	1:00	1:00	1:00	1:00	1:00	1:00	2:00
R02 5-mile ring	6:00	6:10	5:10	6:00	6:00	6:00	6:00	6:00	6:00	6:00	6:00	6:00	6:00	6:00
R03 Entire EPZ	6:10	6:10	5:50	6:10	6:10	6:10	6:10	6:10	6:10	6:10	6:10	6:10	6:10	6:10
Entire 2-Mile Region, 5-Mile Region, and EPZ														
2-Mile Ring and Downwind to 5 Miles														
R04 29° to 50°	4:50	5:00	4:50	4:50	4:50	4:50	4:50	5:00	4:50	4:50	4:50	4:50	4:50	5:00
R05 51° to 106°	4:50	5:00	5:00	4:50	5:00	5:00	4:50	5:00	5:00	5:00	5:00	5:00	5:00	5:00
R06 107° to 140°	4:50	4:50	5:00	4:50	5:00	5:00	4:50	4:50	4:50	5:00	5:00	5:00	5:00	5:00
R07 141° to 174°	4:50	4:50	5:00	4:50	5:00	5:00	4:50	4:50	4:50	5:00	5:00	5:00	5:00	5:00
R08 175° to 230°	3:50	3:50	2:50	3:50	3:50	3:50	3:50	3:50	2:50	2:50	2:50	2:50	2:50	3:50
R09 231° to 286°	6:00	6:10	5:10	6:00	6:00	6:00	6:00	6:00	6:00	6:00	6:00	6:00	6:00	6:00
R10 287° to 331°	6:00	6:10	5:10	6:00	6:00	6:00	6:00	6:00	6:00	6:00	6:00	6:00	6:00	6:00
R01 332° to 28°	1:00	1:00	1:00	1:00	1:00	1:00	1:00	1:00	1:00	1:00	1:00	1:00	1:00	2:00
5-Mile Ring and Downwind to EPZ Boundary														
R11 355° to 50°	6:00	6:10	5:50	6:00	6:00	6:00	6:00	6:00	6:00	6:00	6:00	6:00	6:00	6:00
R12 51° to 61°	6:00	6:10	5:50	6:00	6:00	6:00	6:00	6:10	6:00	6:00	6:00	6:00	6:00	6:00
R13 62° to 95°	6:00	6:10	5:50	6:00	6:00	6:00	6:00	6:10	6:00	6:00	6:00	6:00	6:00	6:00
R14 96° to 129°	6:00	6:10	5:50	6:00	6:00	6:00	6:00	6:10	6:00	6:00	6:00	6:00	6:00	6:00
R15 130° to 163°	6:00	6:10	5:10	6:00	6:00	6:00	6:00	6:00	6:00	6:00	6:00	6:00	6:00	6:00
R16 164° to 174°	6:10	6:10	5:20	6:00	6:00	6:00	6:10	6:10	6:10	6:10	6:10	6:10	6:10	6:00
R17 175° to 219°	6:10	6:10	5:20	6:00	6:00	6:00	6:10	6:10	6:10	6:10	6:10	6:10	6:10	6:10
R18 220° to 230°	6:10	6:10	5:20	6:00	6:00	6:00	6:10	6:10	6:10	6:10	6:10	6:10	6:10	6:10
R19 231° to 286°	6:10	6:10	5:20	6:00	6:00	6:00	6:10	6:10	6:10	6:10	6:10	6:10	6:10	6:10
R20 287° to 298°	6:10	6:10	5:10	6:00	6:00	6:00	6:10	6:10	6:10	6:10	6:10	6:10	6:10	6:00
R21 299° to 343°	6:10	6:10	5:10	6:00	6:00	6:00	6:10	6:10	6:10	6:10	6:10	6:10	6:10	6:00
R22 344° to 354°	6:10	6:10	5:50	6:00	6:00	6:00	6:10	6:10	6:10	6:10	6:10	6:10	6:10	6:00

Table J-2. Description of Evacuation Regions												
Region	Description	ZONE										
		1	2	3	4	5	6	7	8	9	10	11
R01	2 mile ring											
R02	5-mile ring											
R03	Full EPZ											
Evacuate 2 mile ring and 5 miles downwind												
Region	Wind Direction (From) in Degrees	ZONE										
		1	2	3	4	5	6	7	8	9	10	11
R04	29 - 50											
R05	51 - 106											
R06	107 - 140											
R07	141 - 174											
R08	175 - 230											
R09	231 - 286											
R10	287 - 331											
R01*	332 - 28											
Evacuate 5 mile ring and downwind to EPZ boundary												
Region	Wind Direction (From) in Degrees	ZONE										
		1	2	3	4	5	6	7	8	9	10	11
R11	355 - 50											
R12	51 - 61											
R13	62 - 95											
R14	96 - 129											
R15	130 - 163											
R16	164 - 174											
R17	175 - 219											
R18	220 - 230											
R19	231 - 286											
R20	287 - 298											
R21	299 - 343											
R22	344 - 354											

**Residents and Transients in the Matagorda Beach area are always evacuated.**

\* Note that evacuating the 2-mile ring and evacuating the 5-mile ring with wind from 332° to 28° both result in the evacuation of Region 1. Thus, R01 is shown twice in the table above.

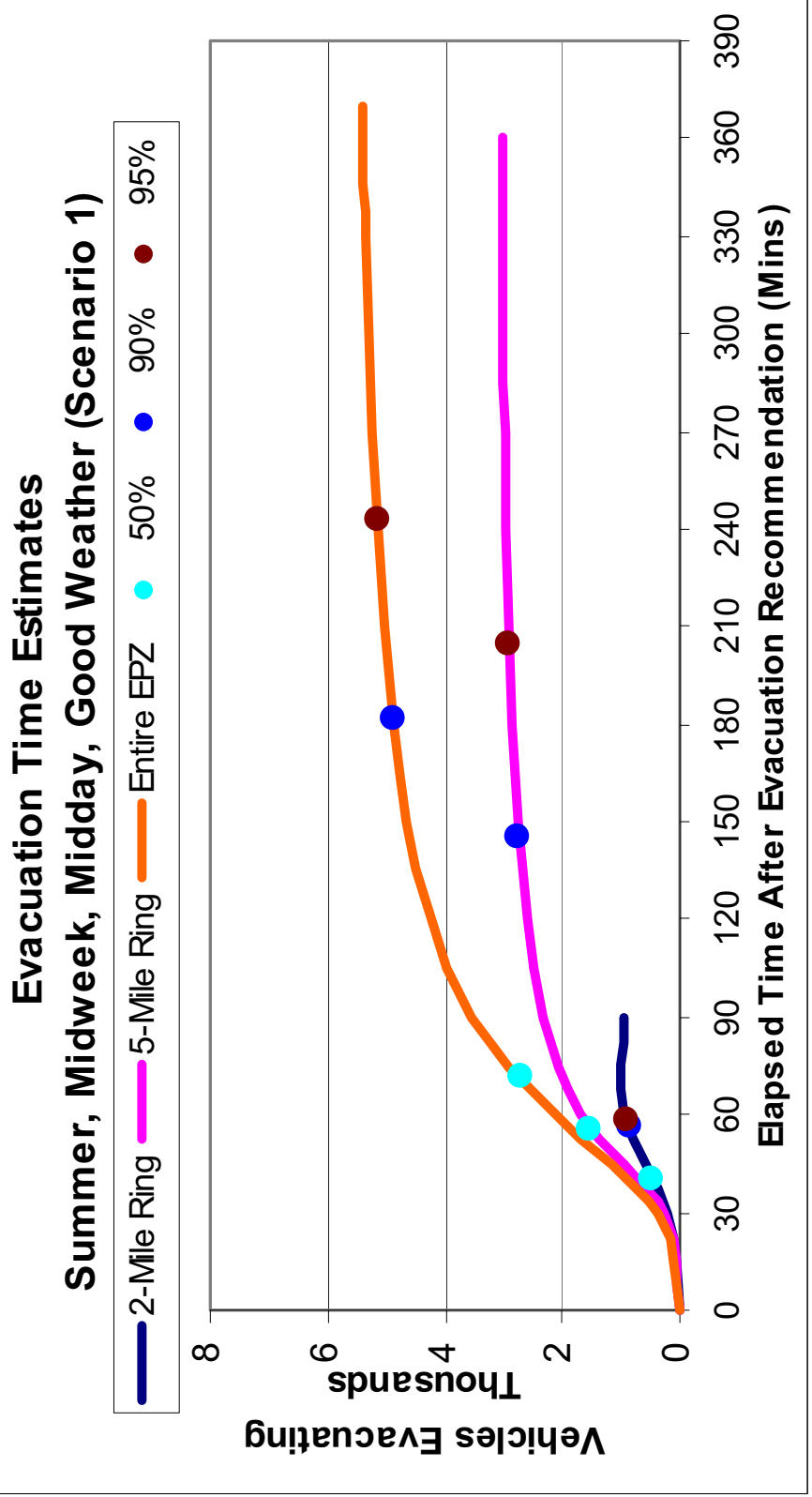


Figure J-1. Evacuation Time Estimates Scenario 1 for Region R03 (Entire EPZ)

## Evacuation Time Estimates Summer, Midweek, MIDDAY, Rain (Scenario 2)

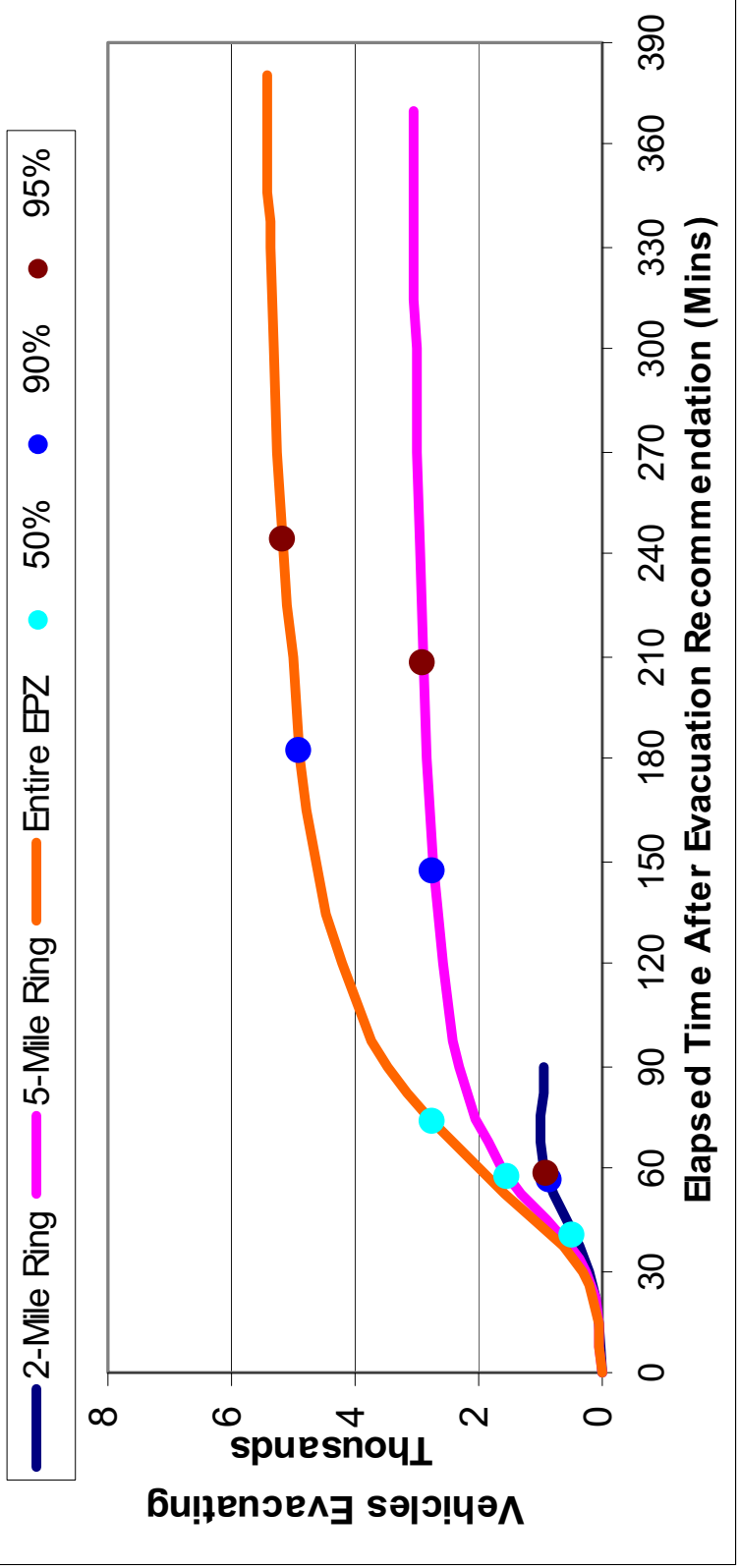


Figure J-2. Evacuation Time Estimates Scenario 2 for Region R03 (Entire EPZ)

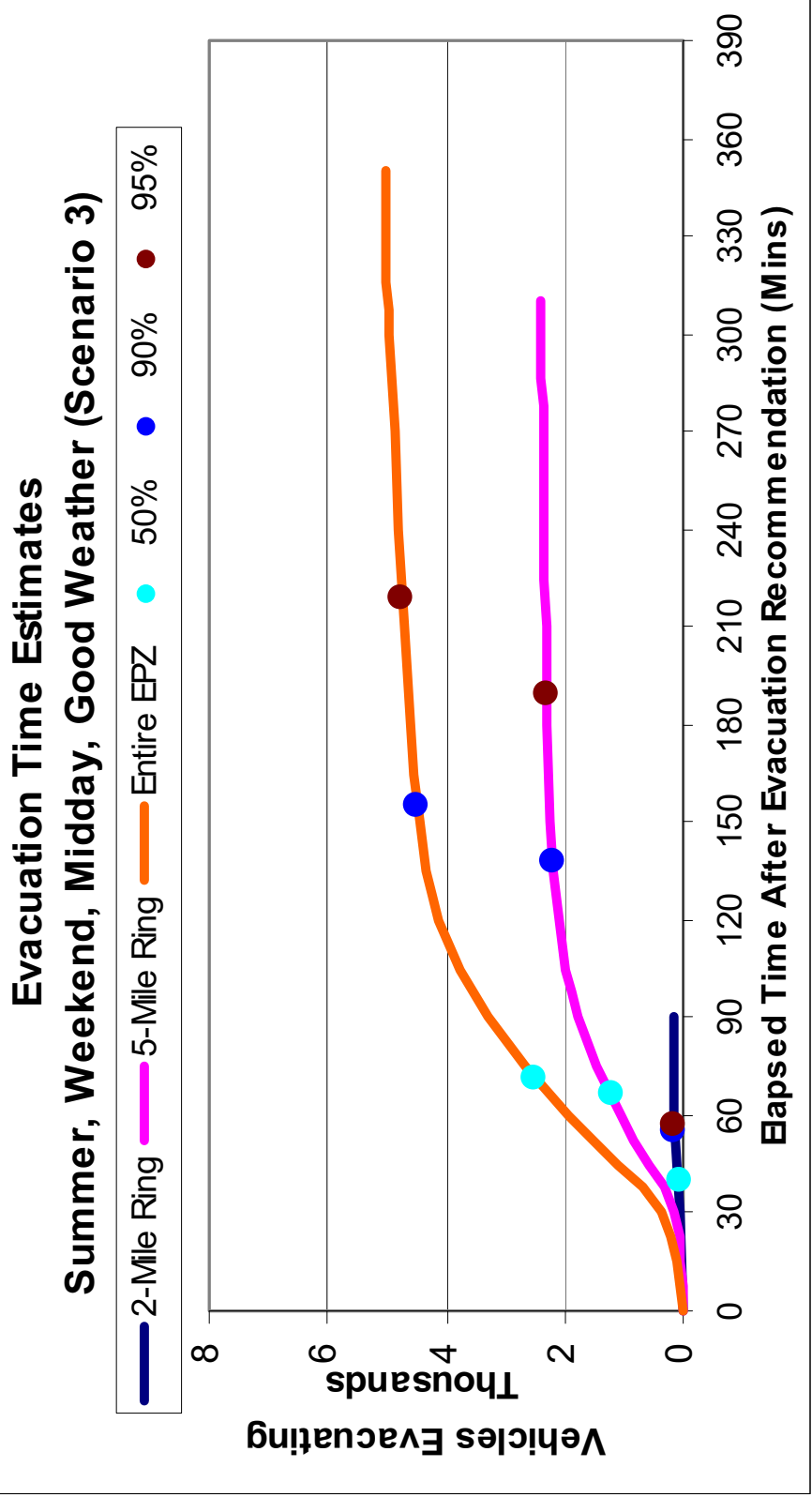


Figure J-3. Evacuation Time Estimates Scenario 3 for Region R03 (Entire EPZ)

## Evacuation Time Estimates Summer, Weekend, Midday, Rain (Scenario 4)

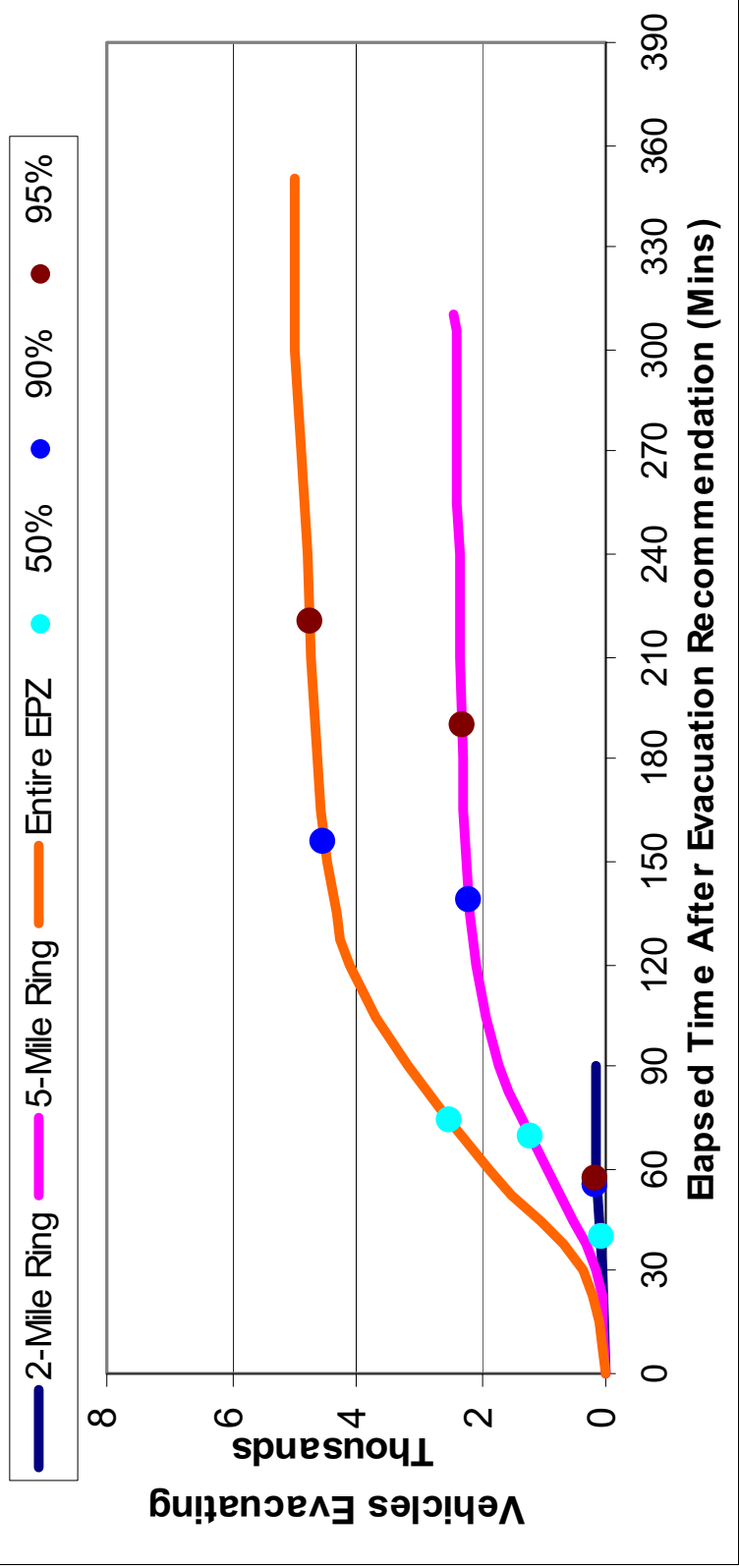


Figure J-4. Evacuation Time Estimates  
Scenario 4 for Region R03 (Entire EPZ)

## Evacuation Time Estimates Summer, Evening, Good Weather (Scenario 5)

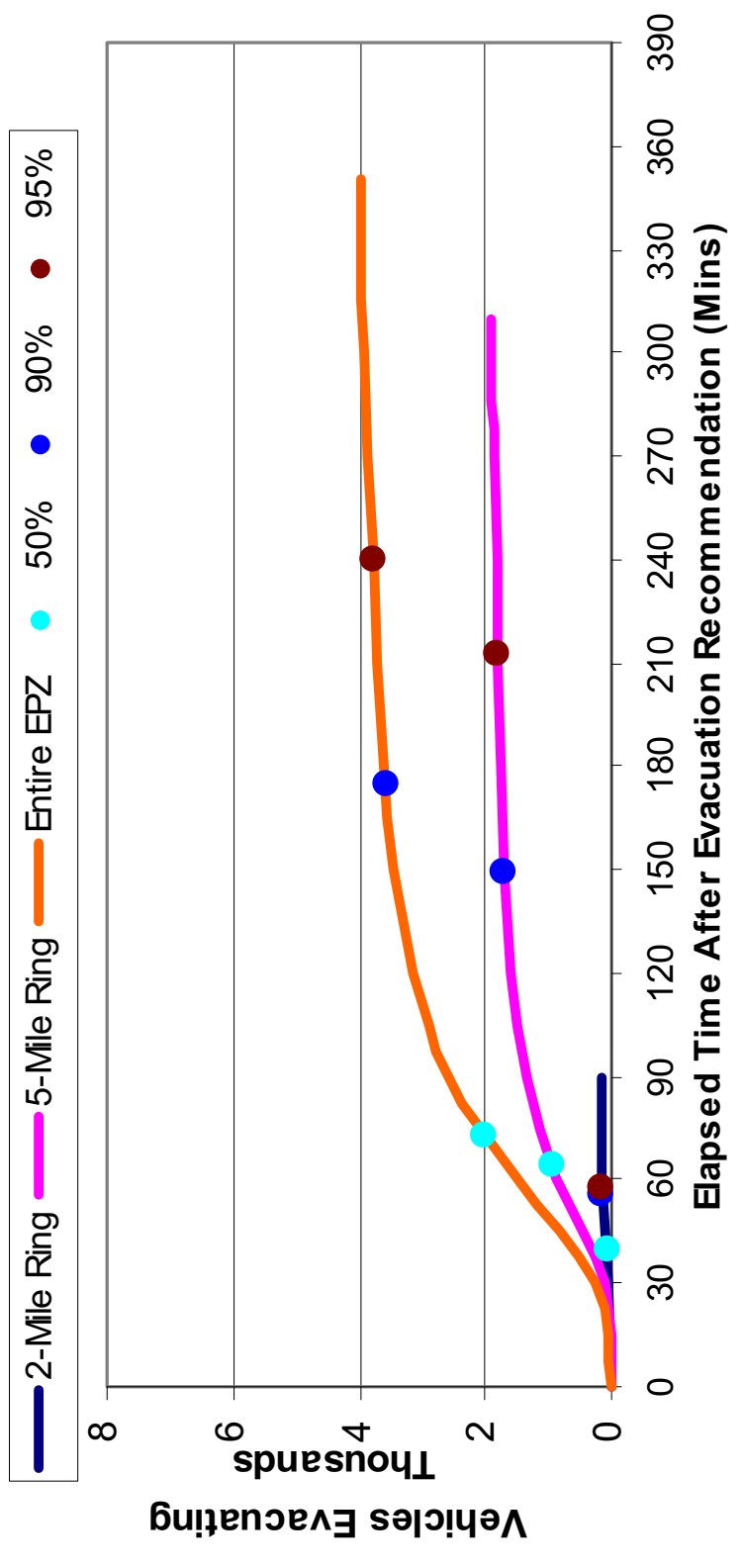


Figure J-5. Evacuation Time Estimates  
Scenario 5 for Region R03 (Entire EPZ)

### Evacuation Time Estimates

#### Winter, Midweek, Midday, Good Weather (Scenario 6)

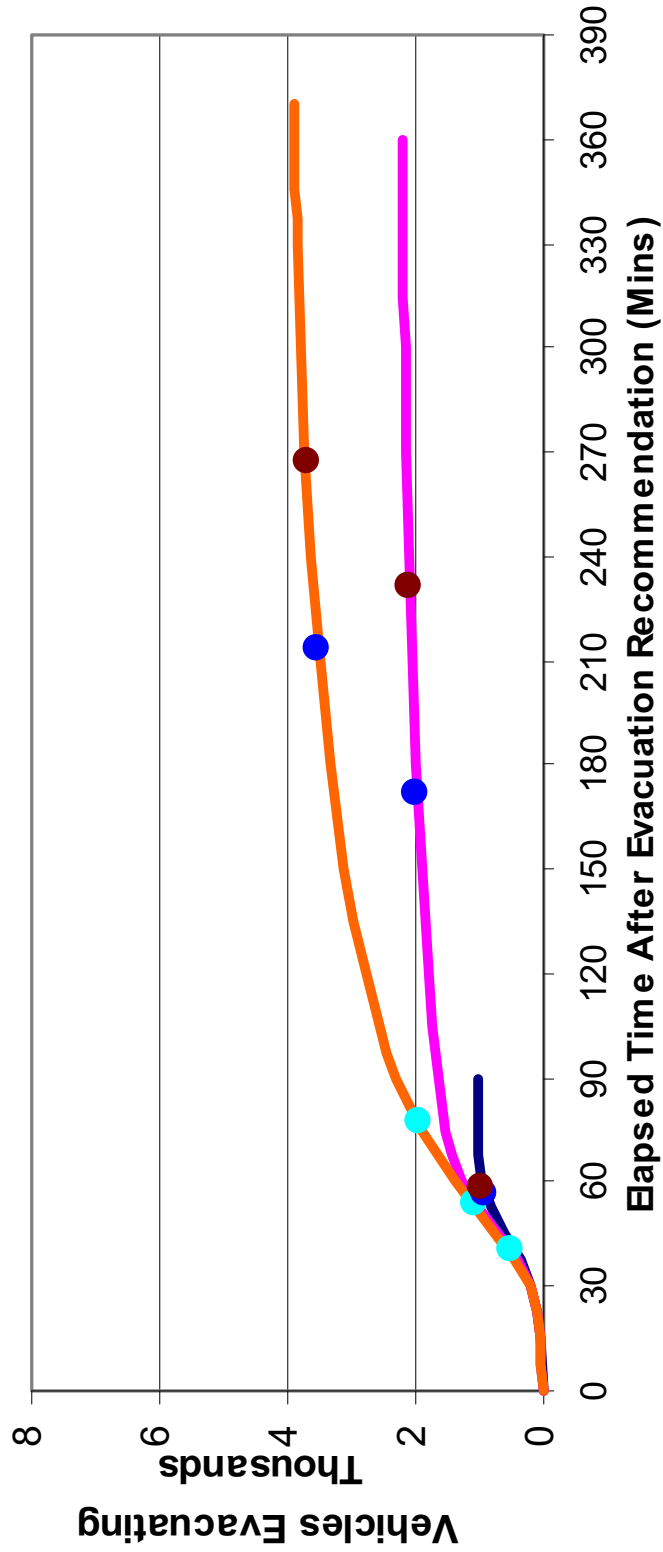


Figure J-6. Evacuation Time Estimates Scenario 6 for Region R03 (Entire EPZ)



### Evacuation Time Estimates Winter, Midweek, Midday, Rain (Scenario 7)

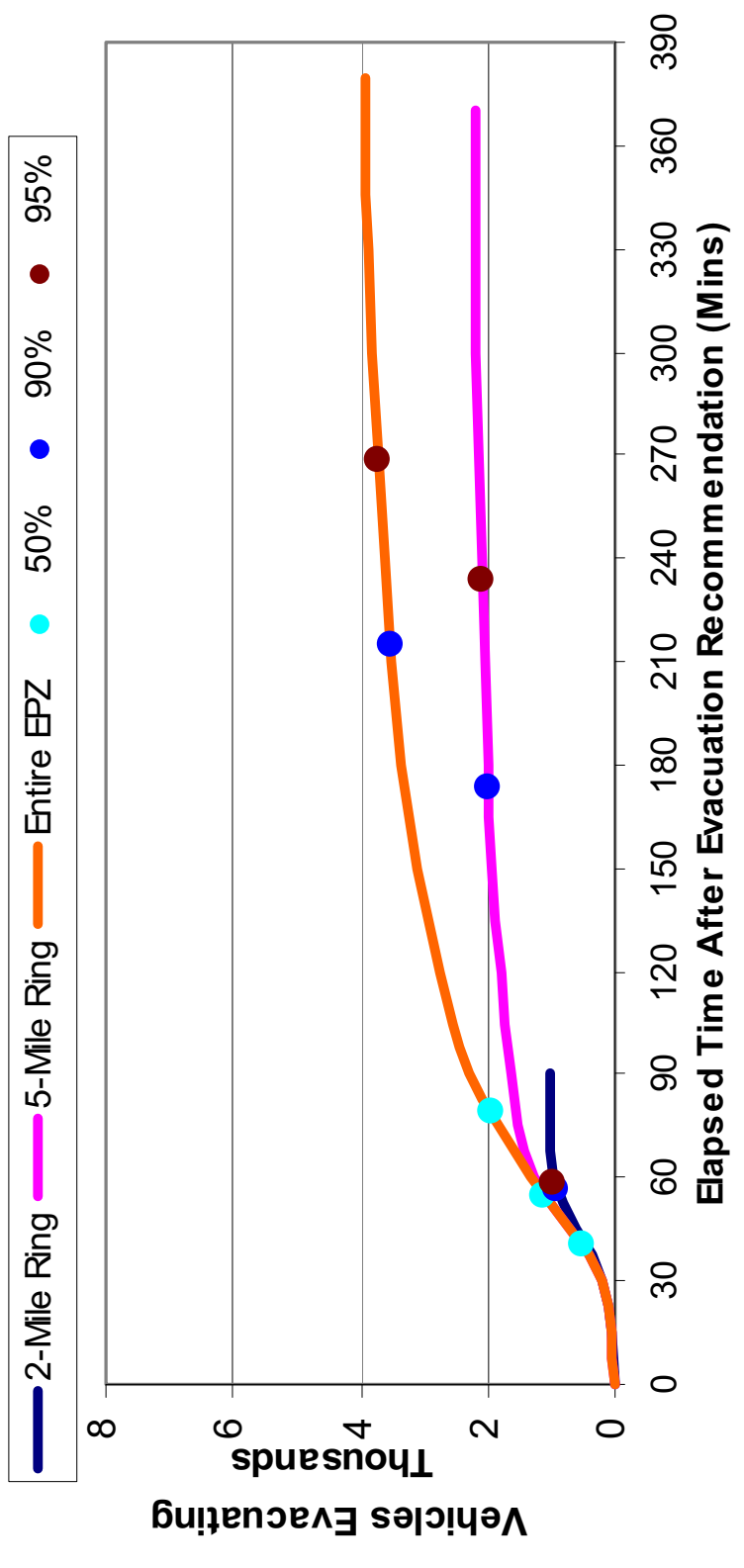


Figure J-7. Evacuation Time Estimates  
Scenario 7 for Region R03 (Entire EPZ)

## Evacuation Time Estimates Winter, Weekend, Midday, Good Weather (Scenario 8)

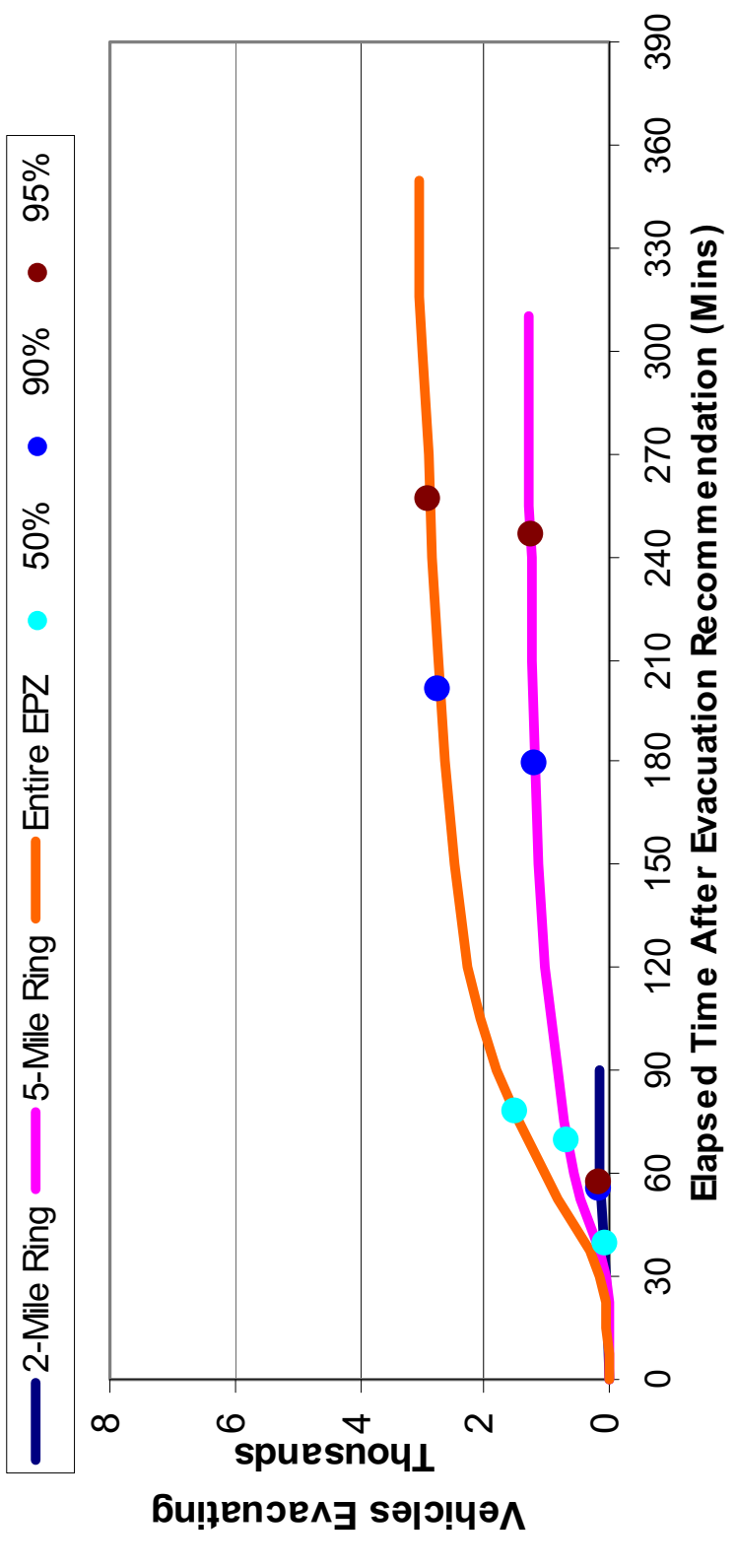


Figure J-8. Evacuation Time Estimates Scenario 8 for Region R03 (Entire EPZ)

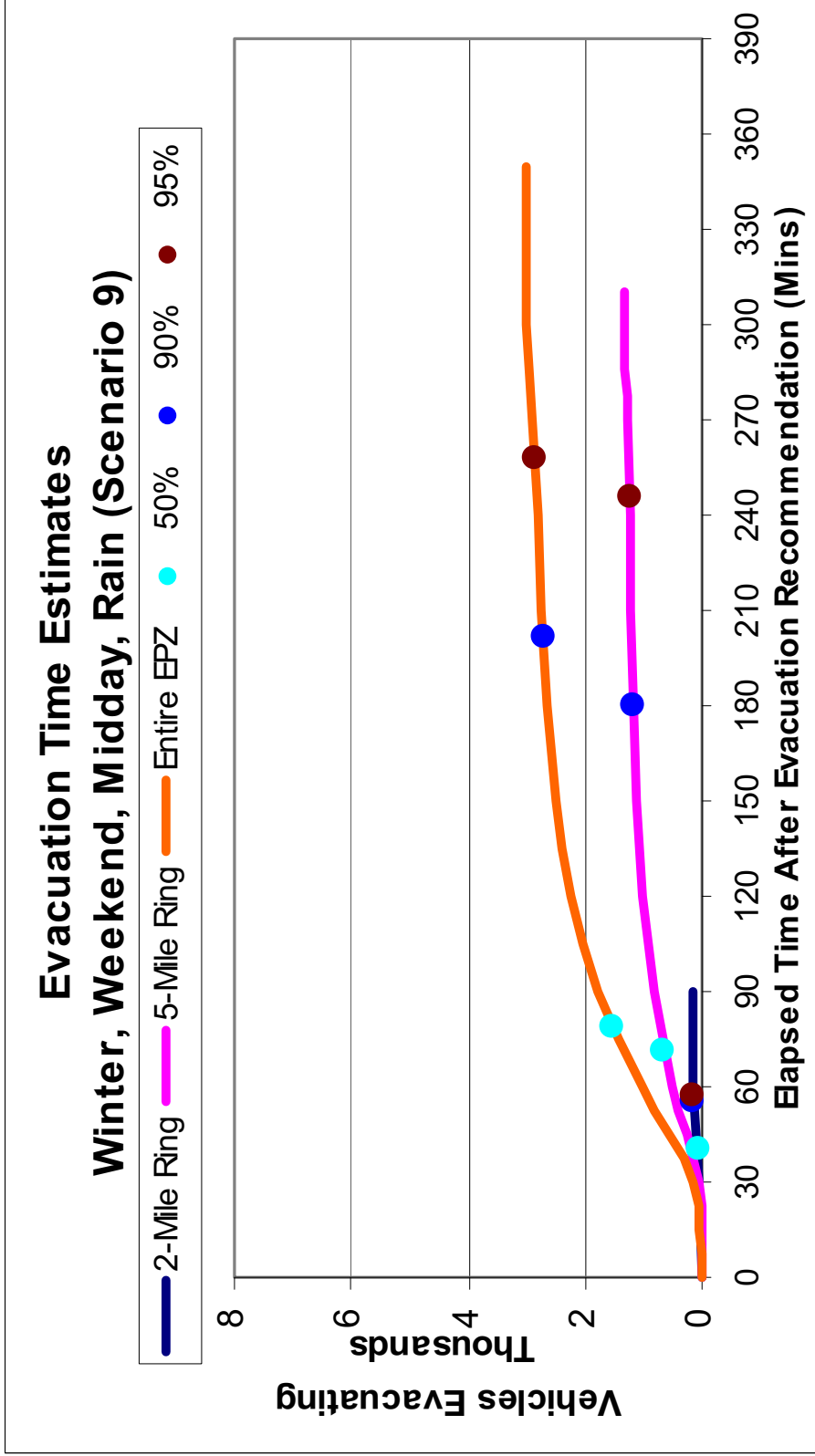


Figure J-9. Evacuation Time Estimates Scenario 9 for Region R03 (Entire EPZ)

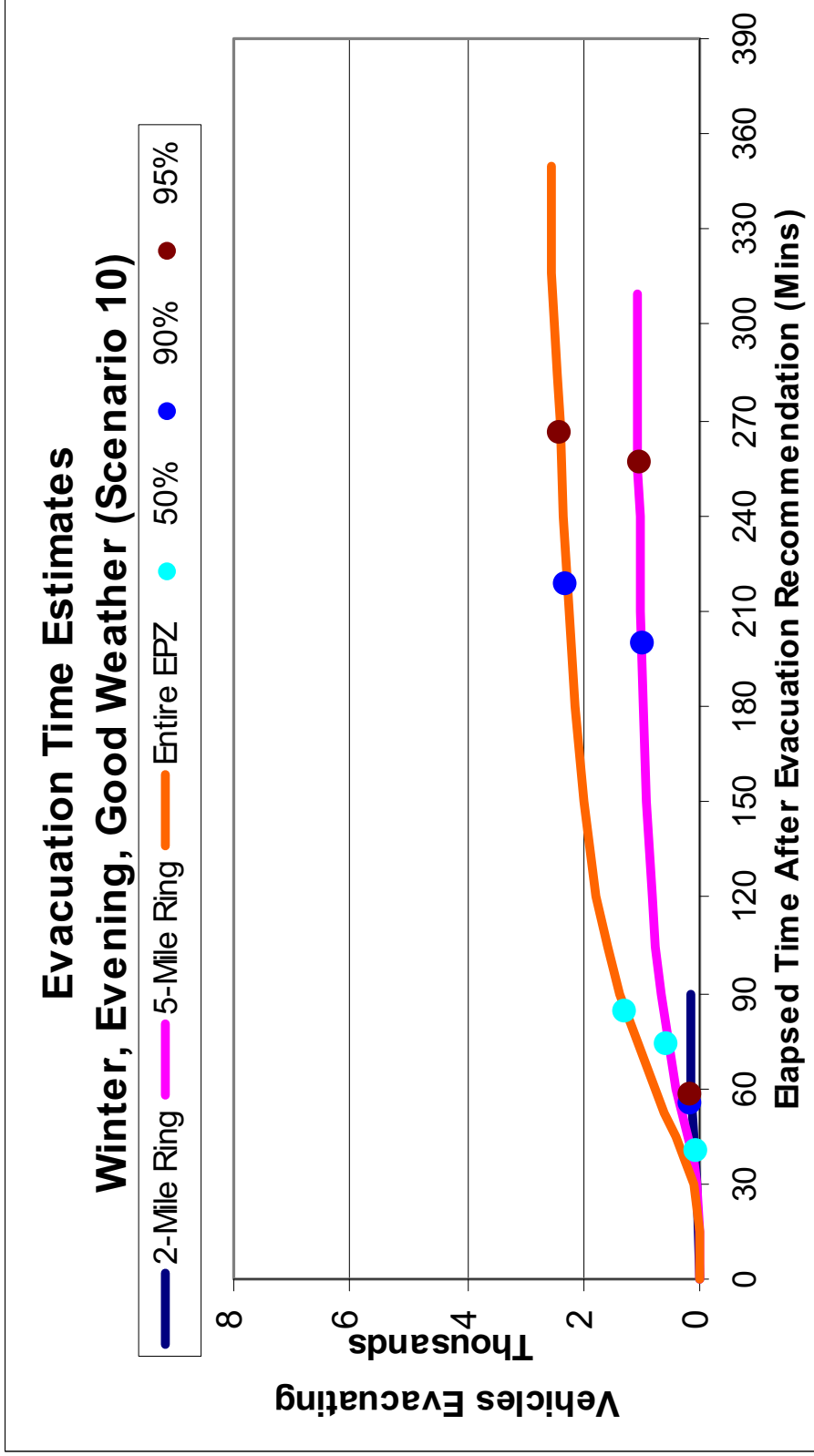


Figure J-10. Evacuation Time Estimates Scenario 10 for Region R03 (Entire EPZ)

## Evacuation Time Estimates Summer, Weekend, Midday, Beach Holiday (Scenario 11)

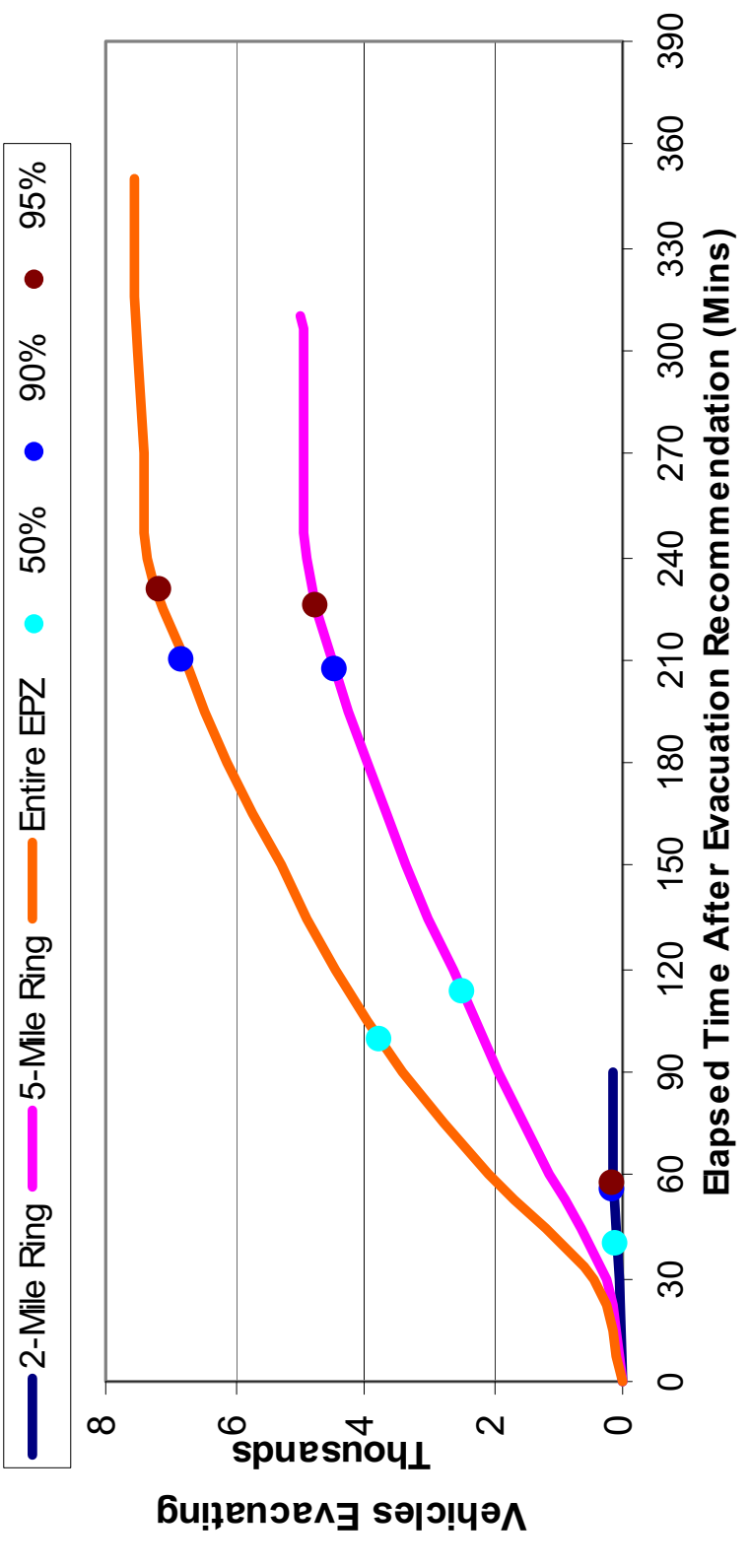


Figure J-11. Evacuation Time Estimates Scenario 11 for Region R03 (Entire EPZ)

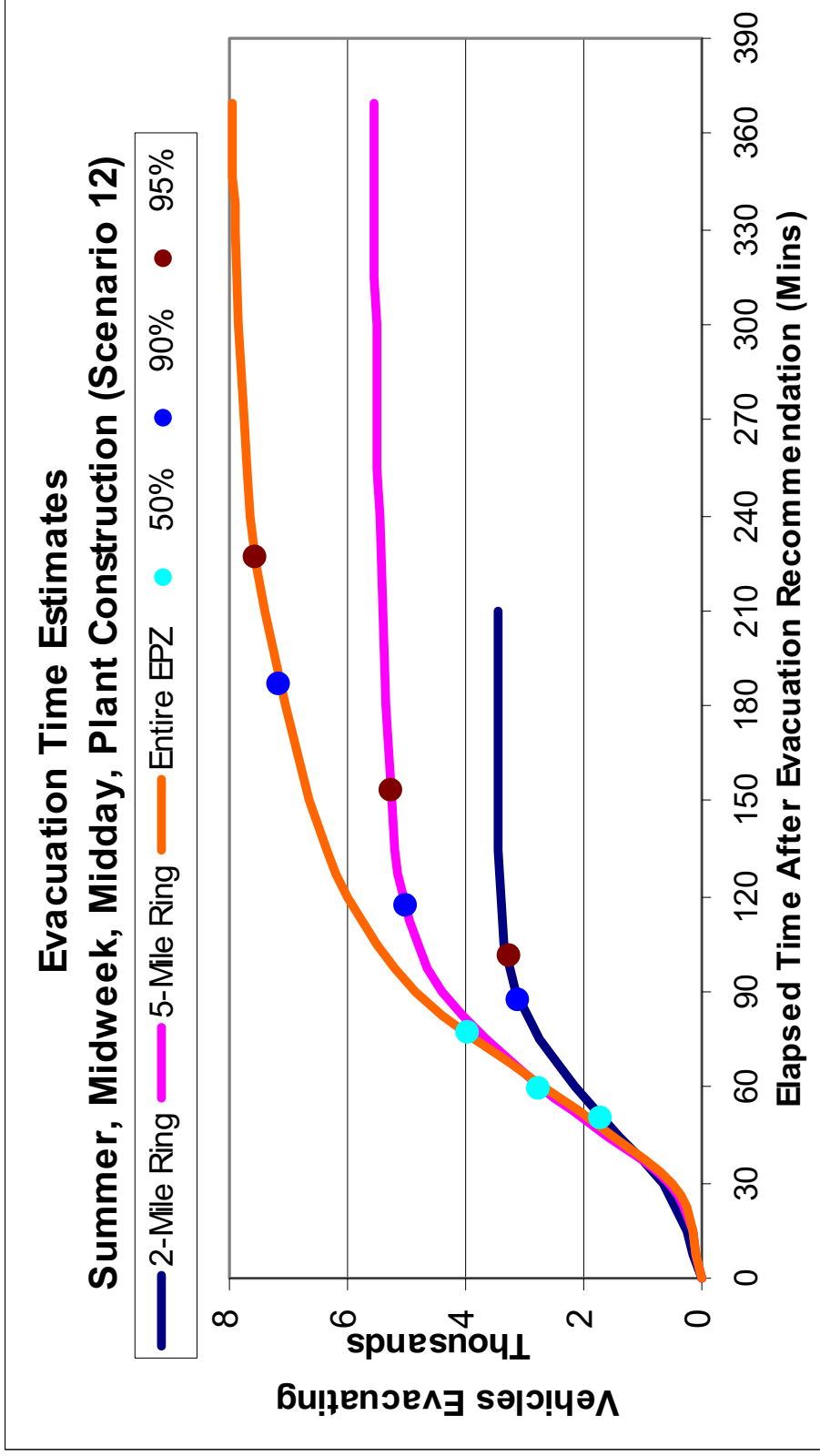


Figure J-12. Evacuation Time Estimates Scenario 12 for Region R03 (Entire EPZ)

APPENDIX K

Evacuation Roadway Network Characteristics

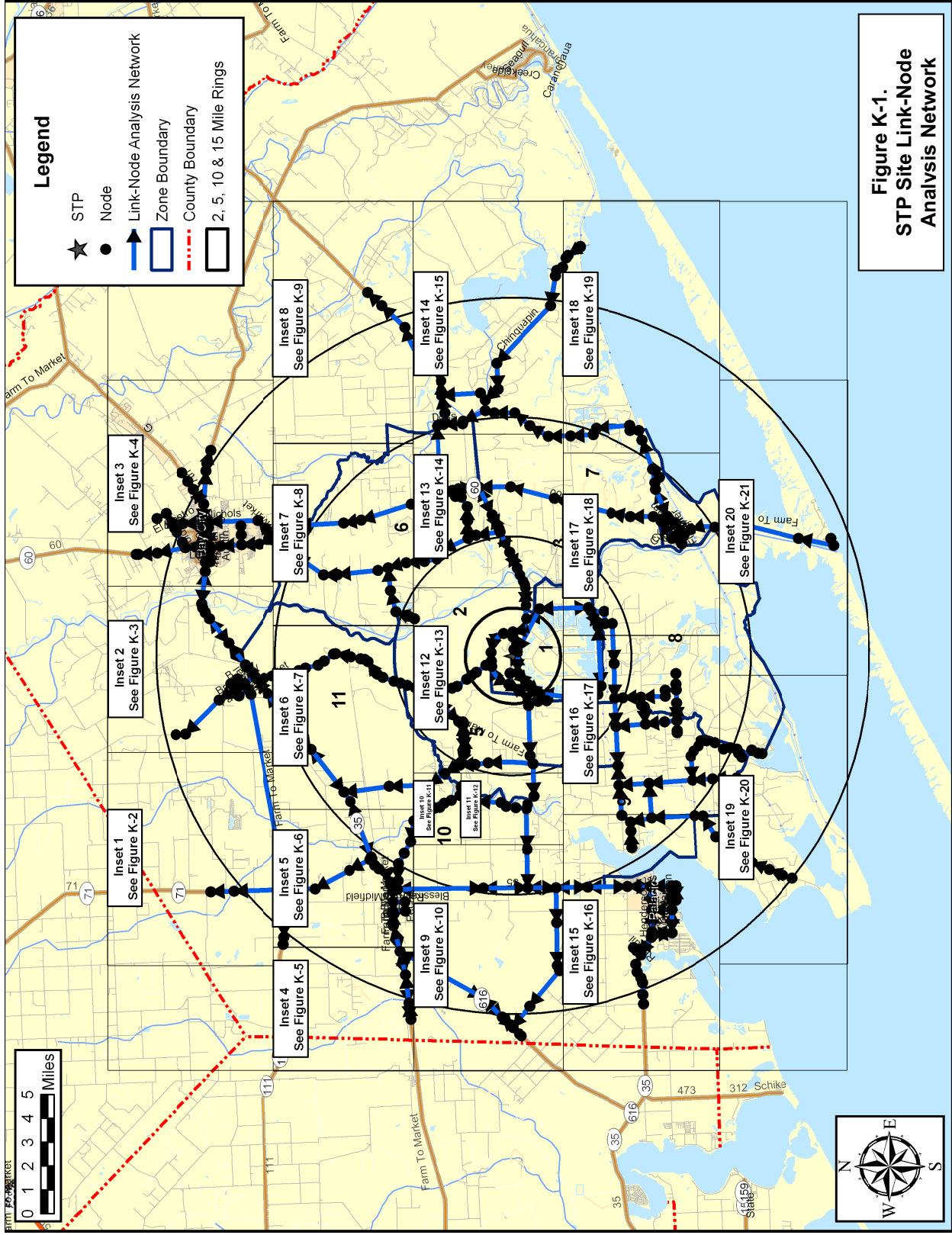
## APPENDIX K: EVACUATION ROADWAY NETWORK CHARACTERISTICS

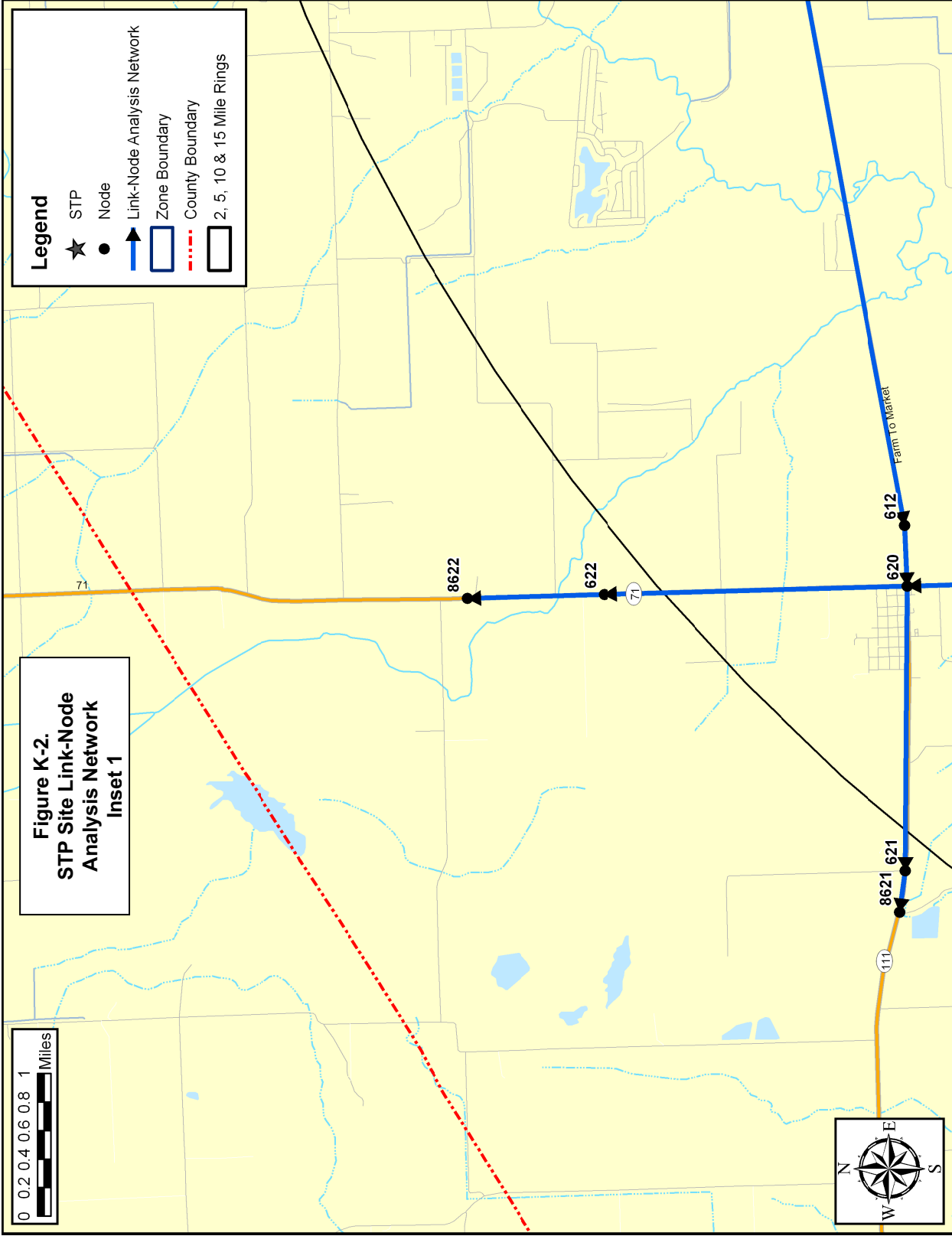
As discussed in Section 1.3, a computerized link-node analysis network was constructed to model the roadway network within the study area. Figure K-1 provides an overview of the link-node analysis network. The figure has been divided up into 20 more detailed figures (Figures K-2 through K-21) which show each of the links and nodes in the network.

The analysis network was calibrated using the observations made during the field survey discussed in Section 1.3. Table K-1 lists the characteristics of each roadway section modeled in the ETE analysis. Each link is identified by its upstream and downstream node numbers. These node numbers can be cross-referenced to Figures K-1 through K-21 to identify the geographic location of each link.

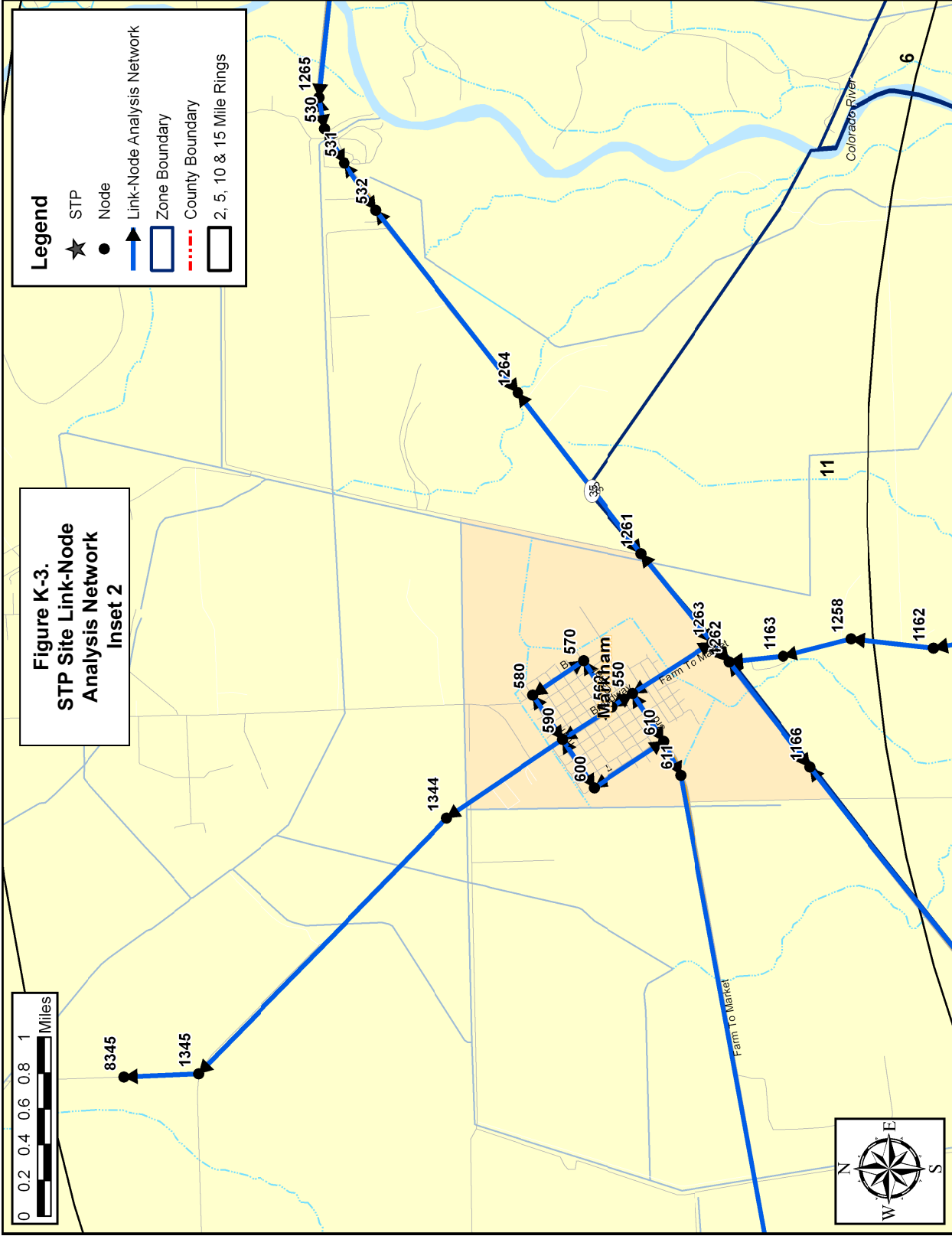
The term, "Full Lanes" in Table K-1 identifies the number of lanes that extend throughout the length of the link. Many links have additional lanes on the immediate approach to an intersection (turn pockets); these have been recorded and entered into the I-DYNEV System input stream.







**Figure K-2.**  
**STP Site Link-Node**  
**Analysis Network**  
**Inset 1**



**Figure K-3.**  
**STP Site Link-Node**  
**Analysis Network**  
**Inset 2**

STP  
 Evacuation Time Estimate

K-4

KLD Associates, Inc.  
 Rev. 3

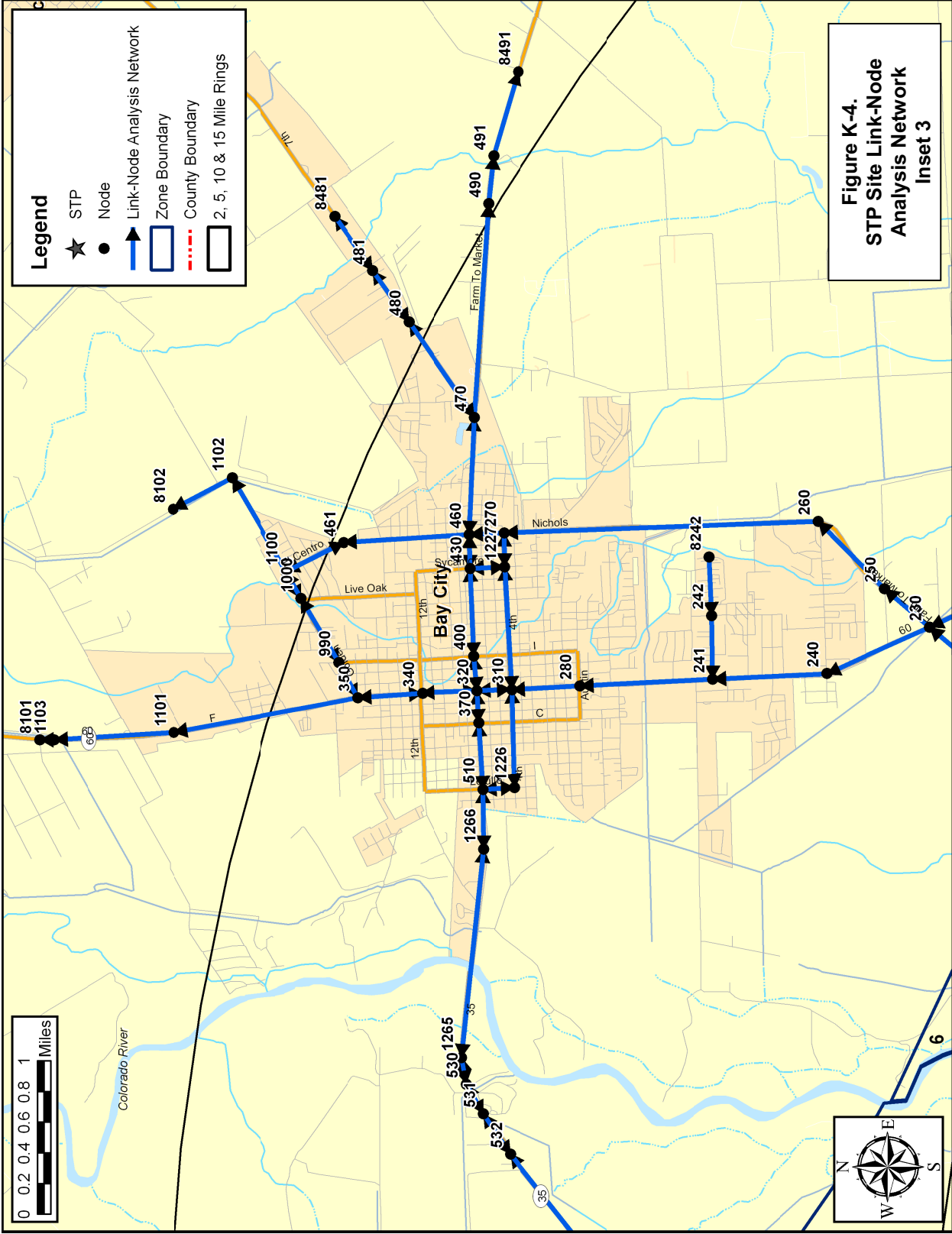
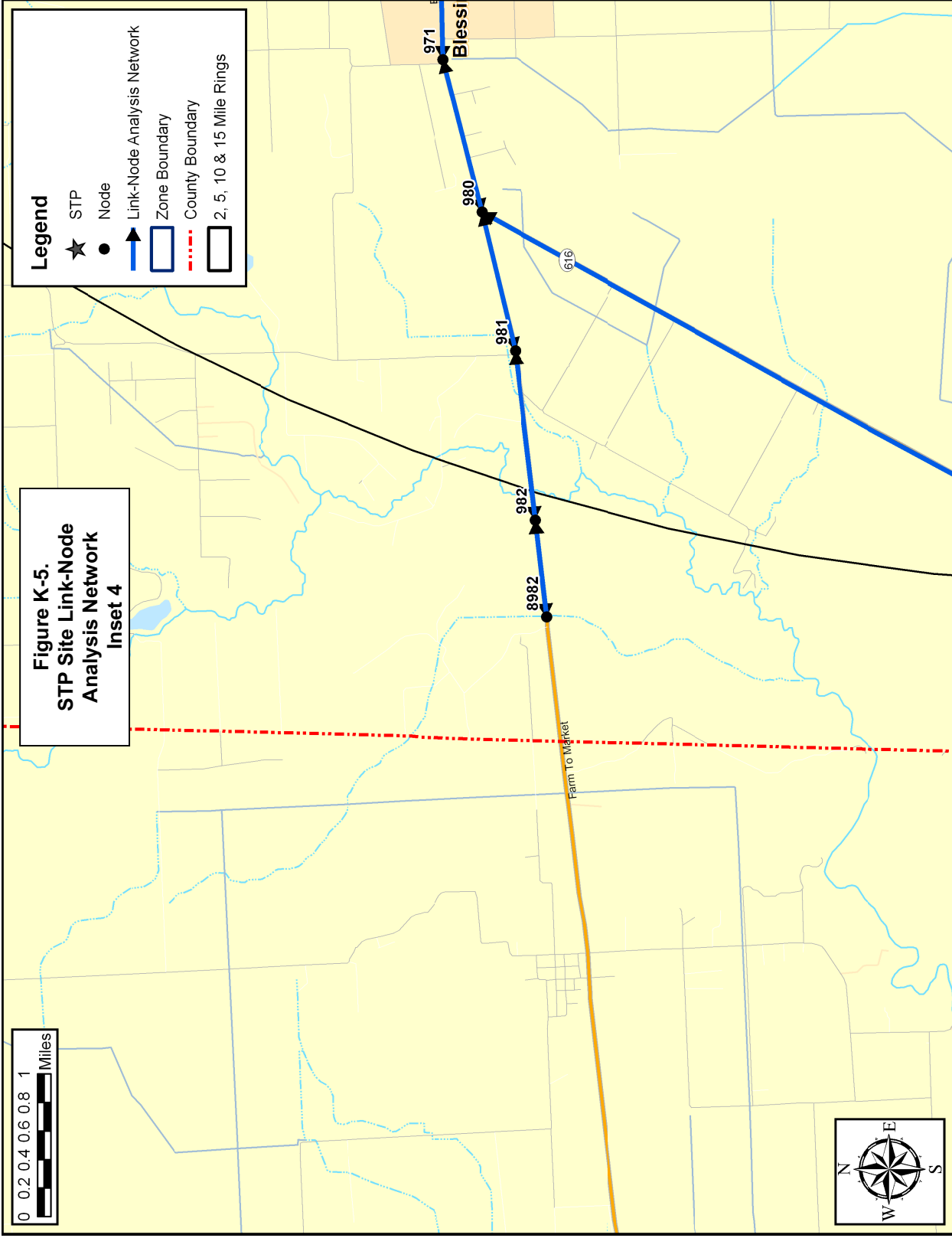


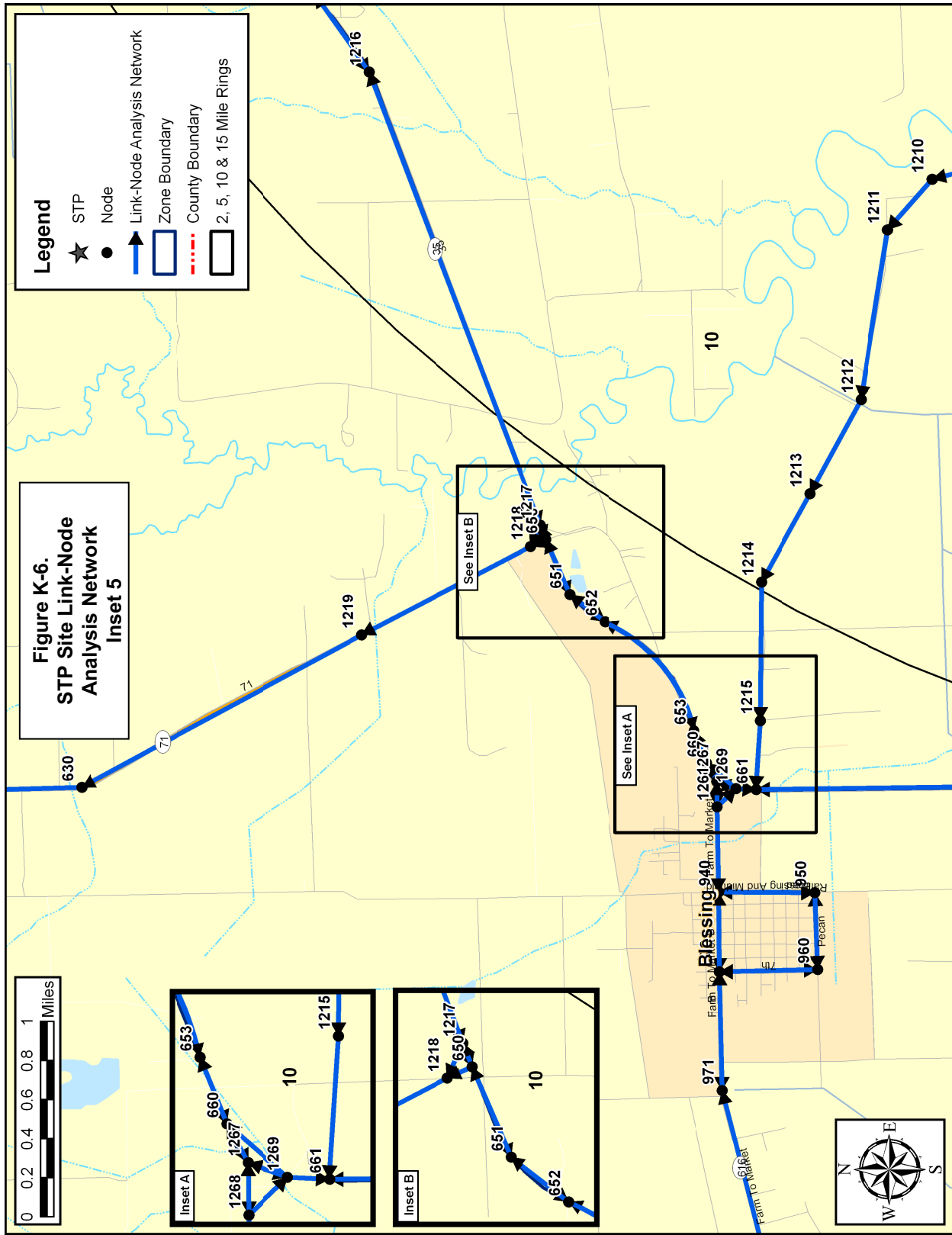
Figure K-4.  
STP Site Link-Node  
Analysis Network  
Inset 3

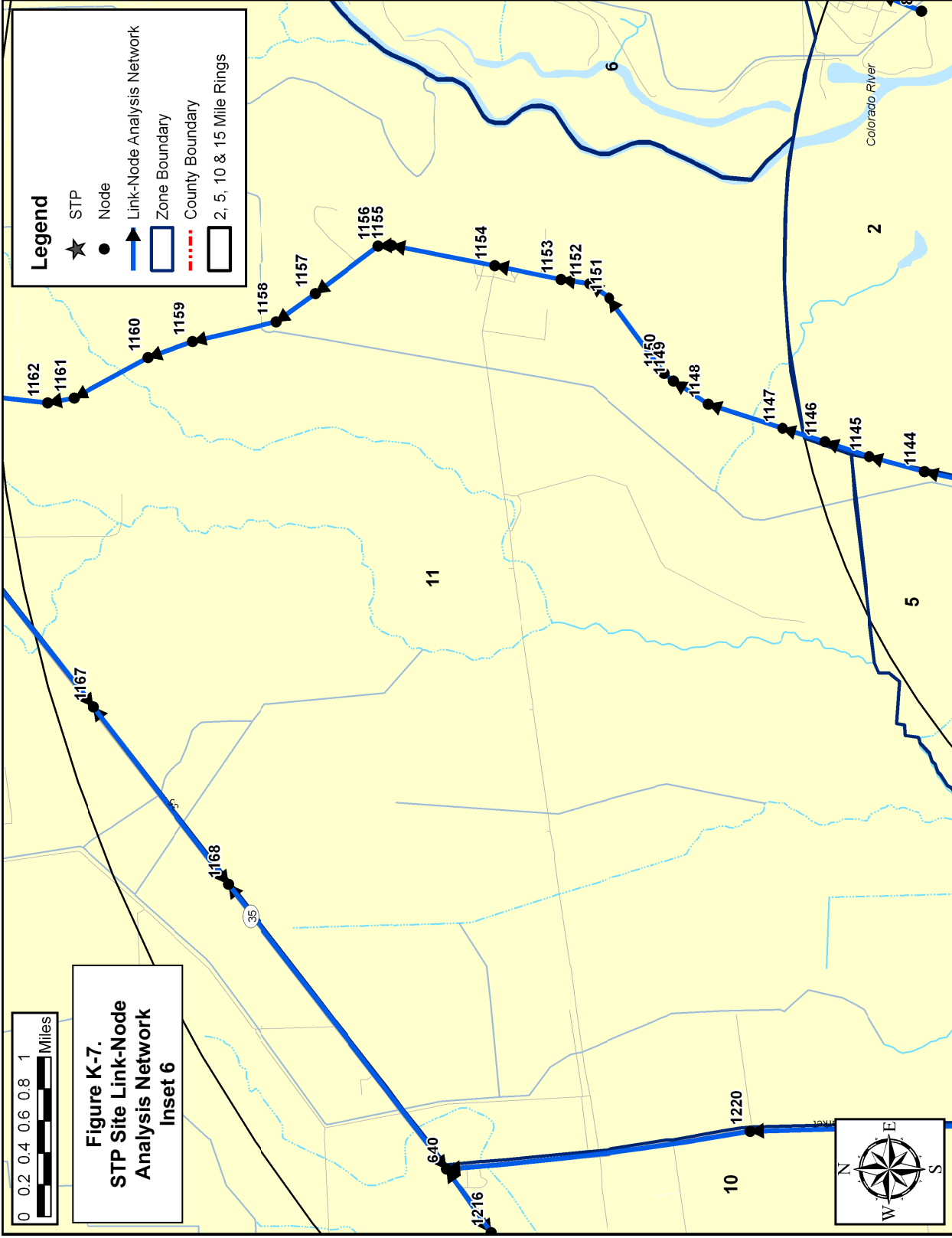
K-5

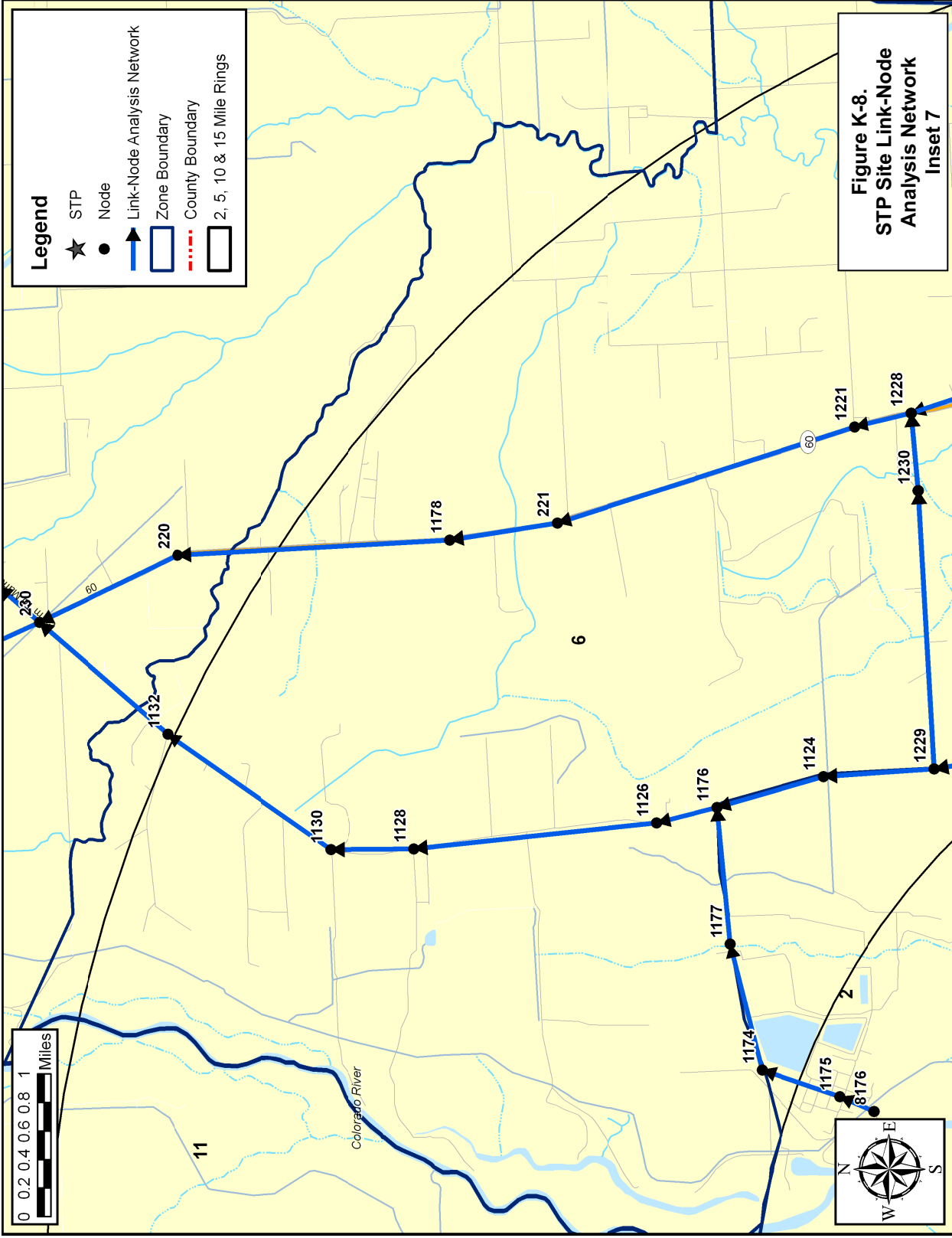
STP  
Evacuation Time Estimate

KLD Associates, Inc.  
Rev. 3

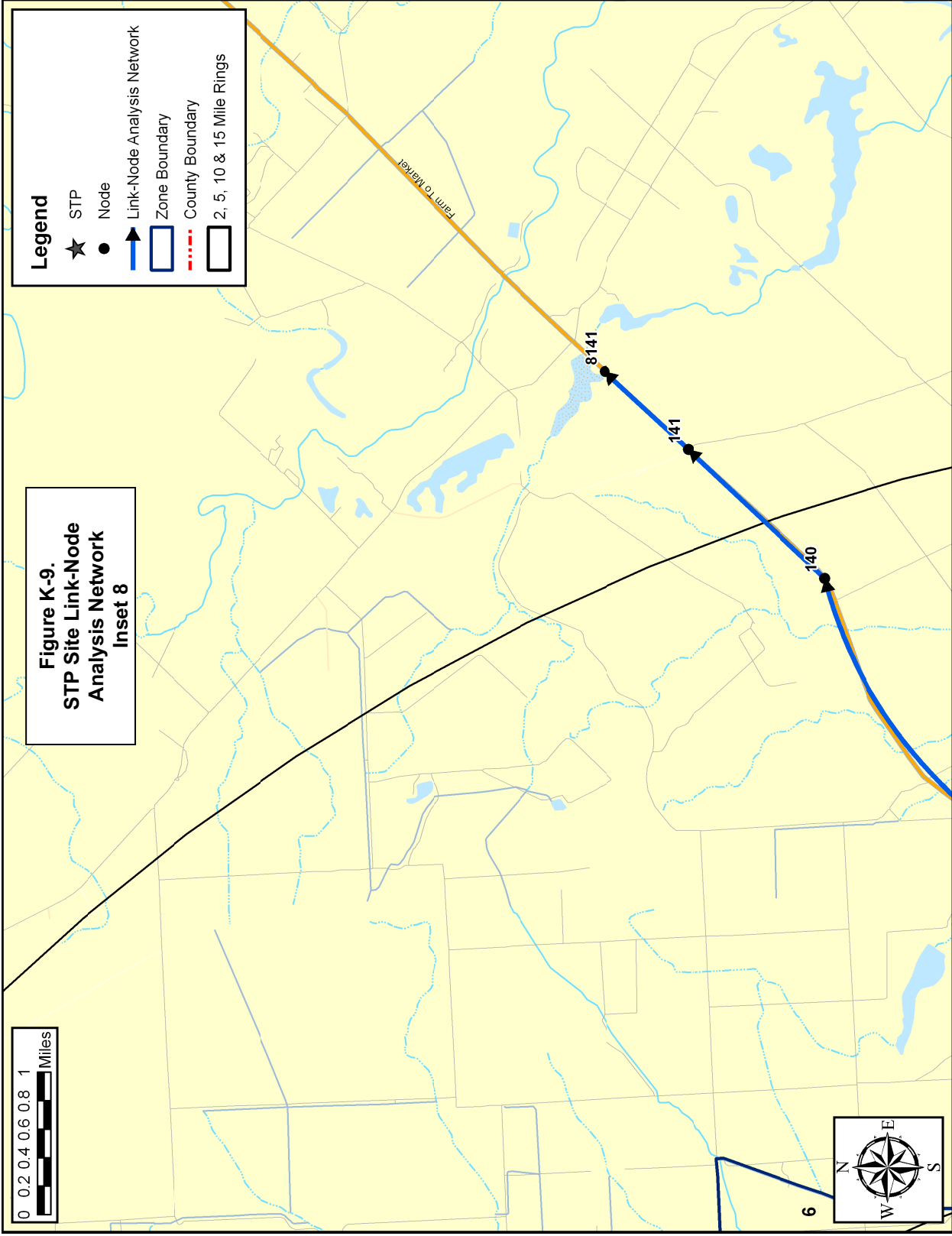








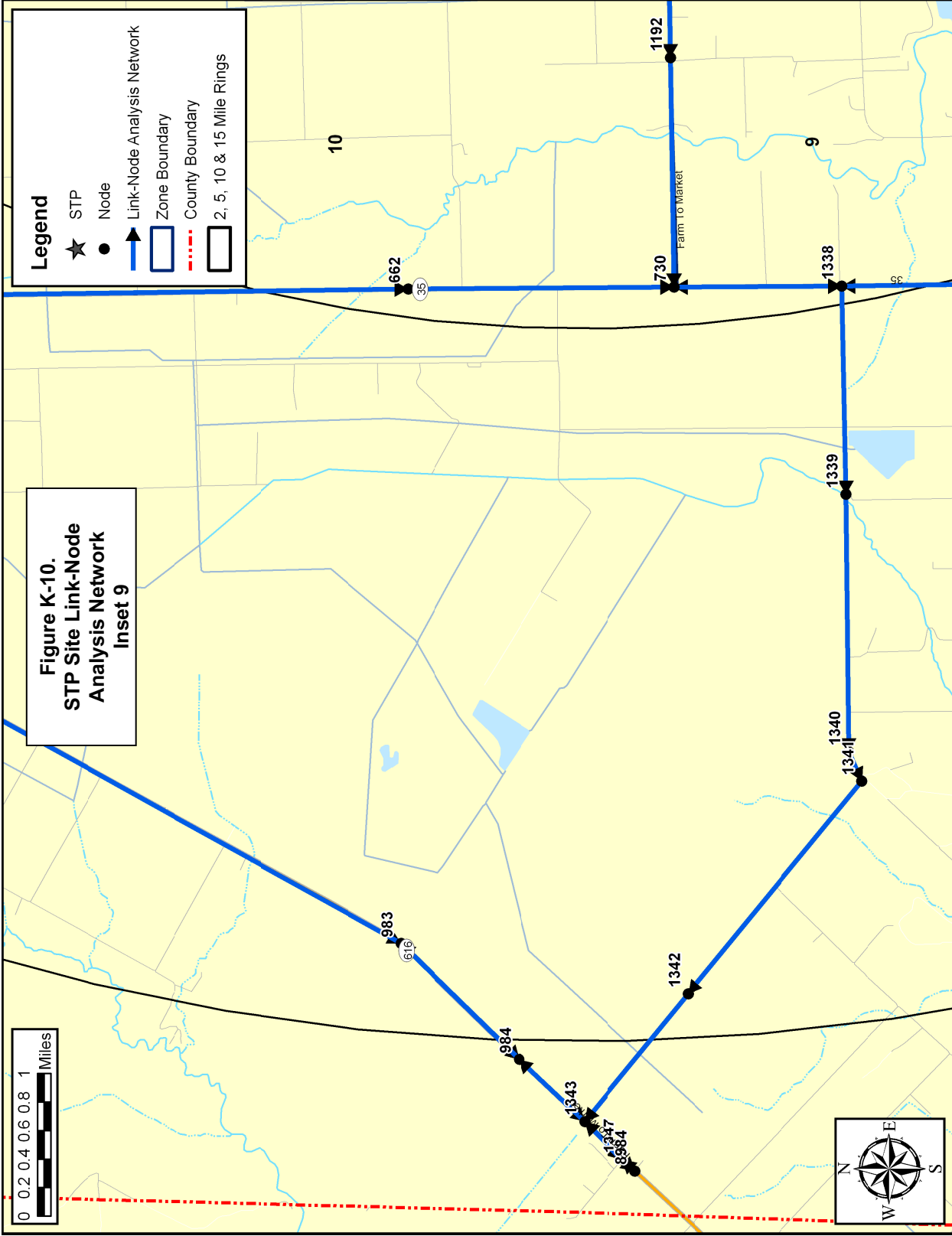


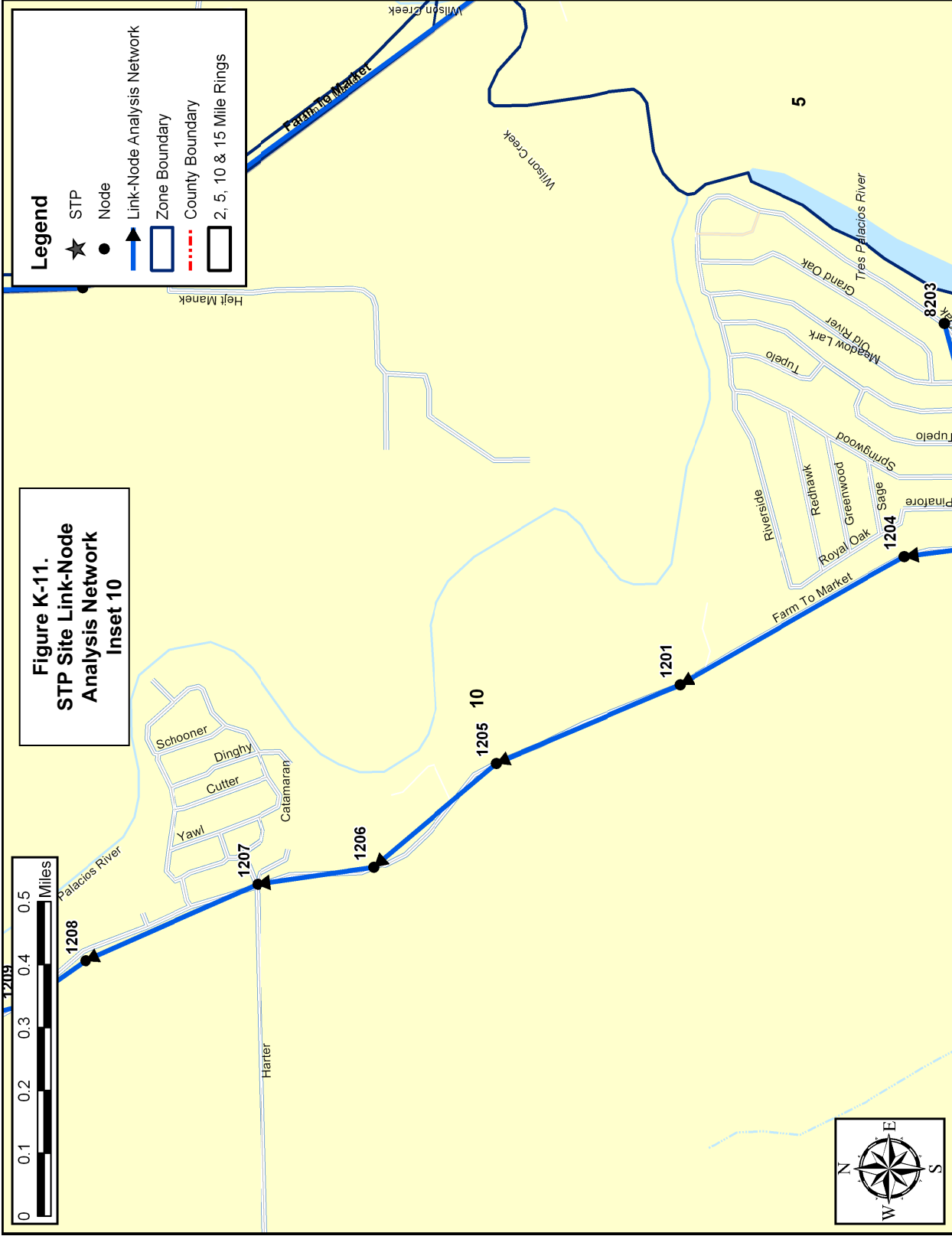


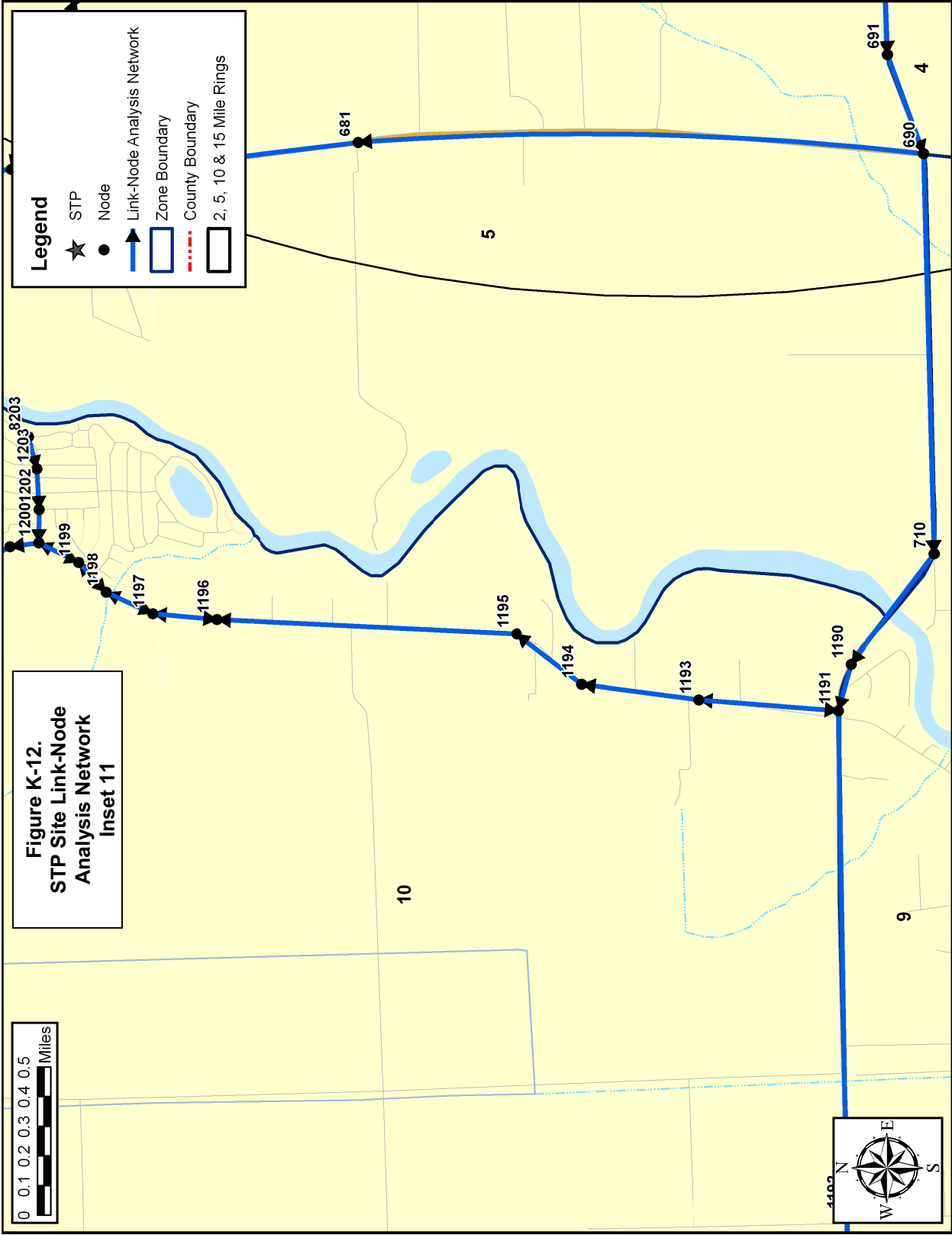
STP  
 Evacuation Time Estimate

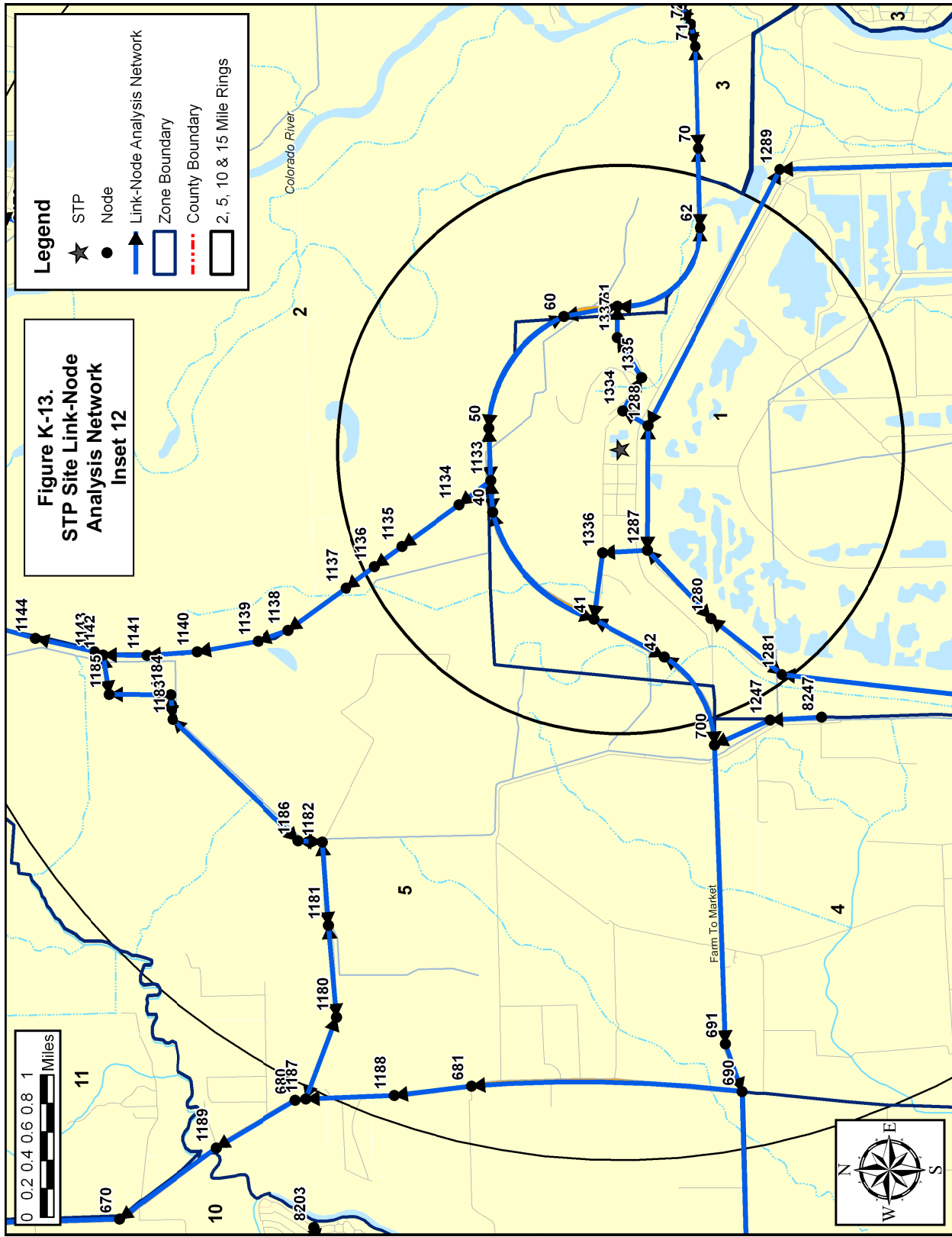
K-10

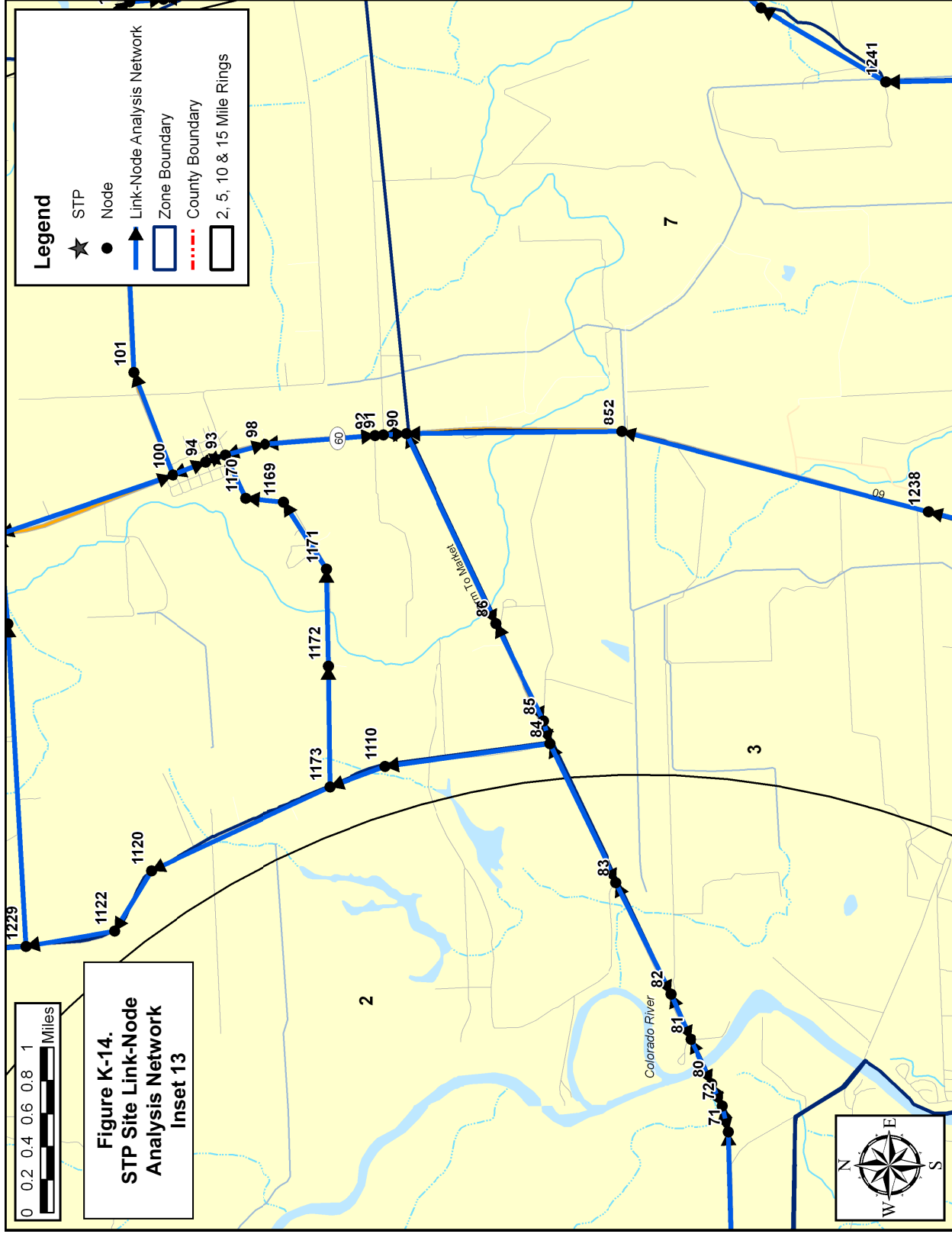
KLD Associates, Inc.  
 Rev. 3



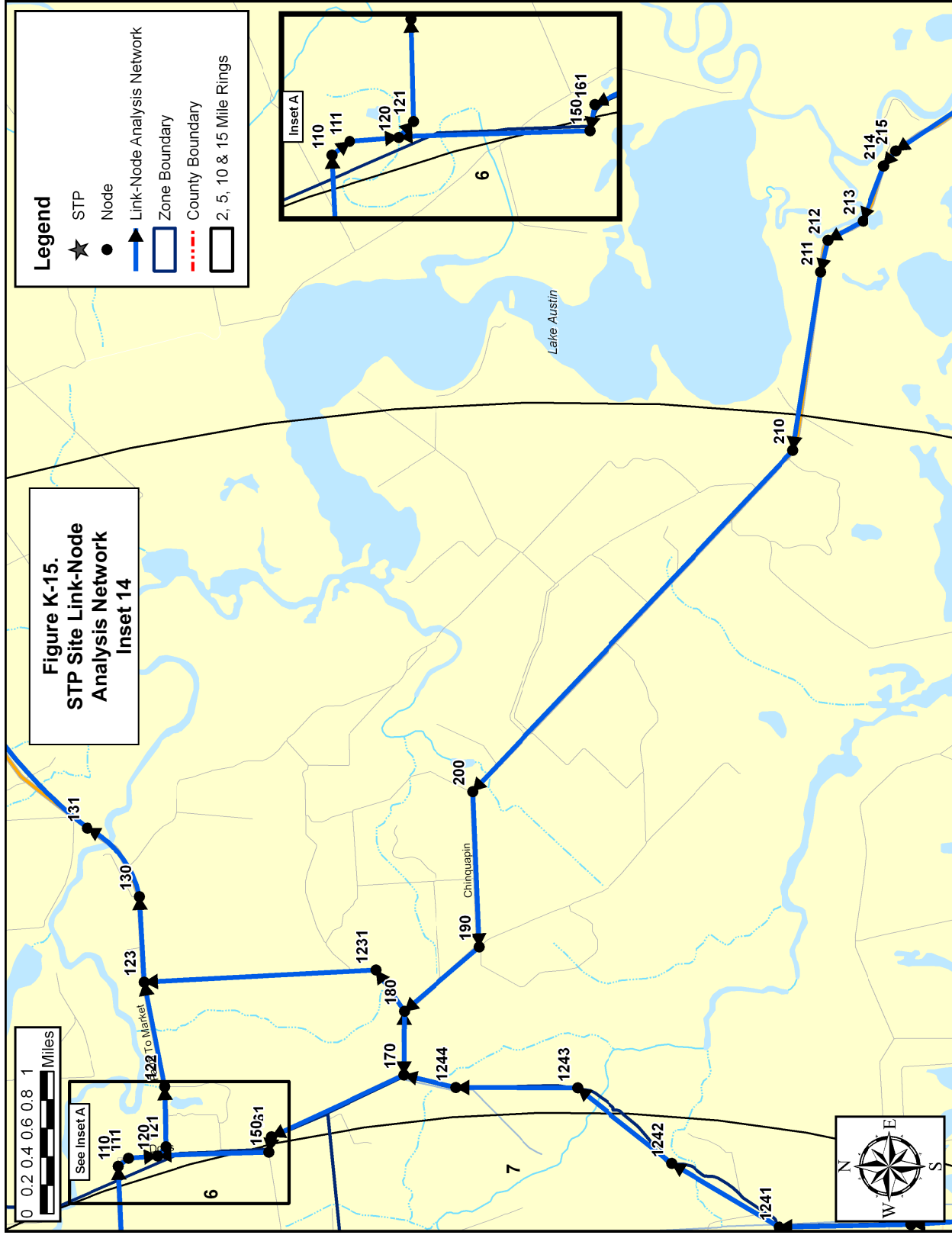


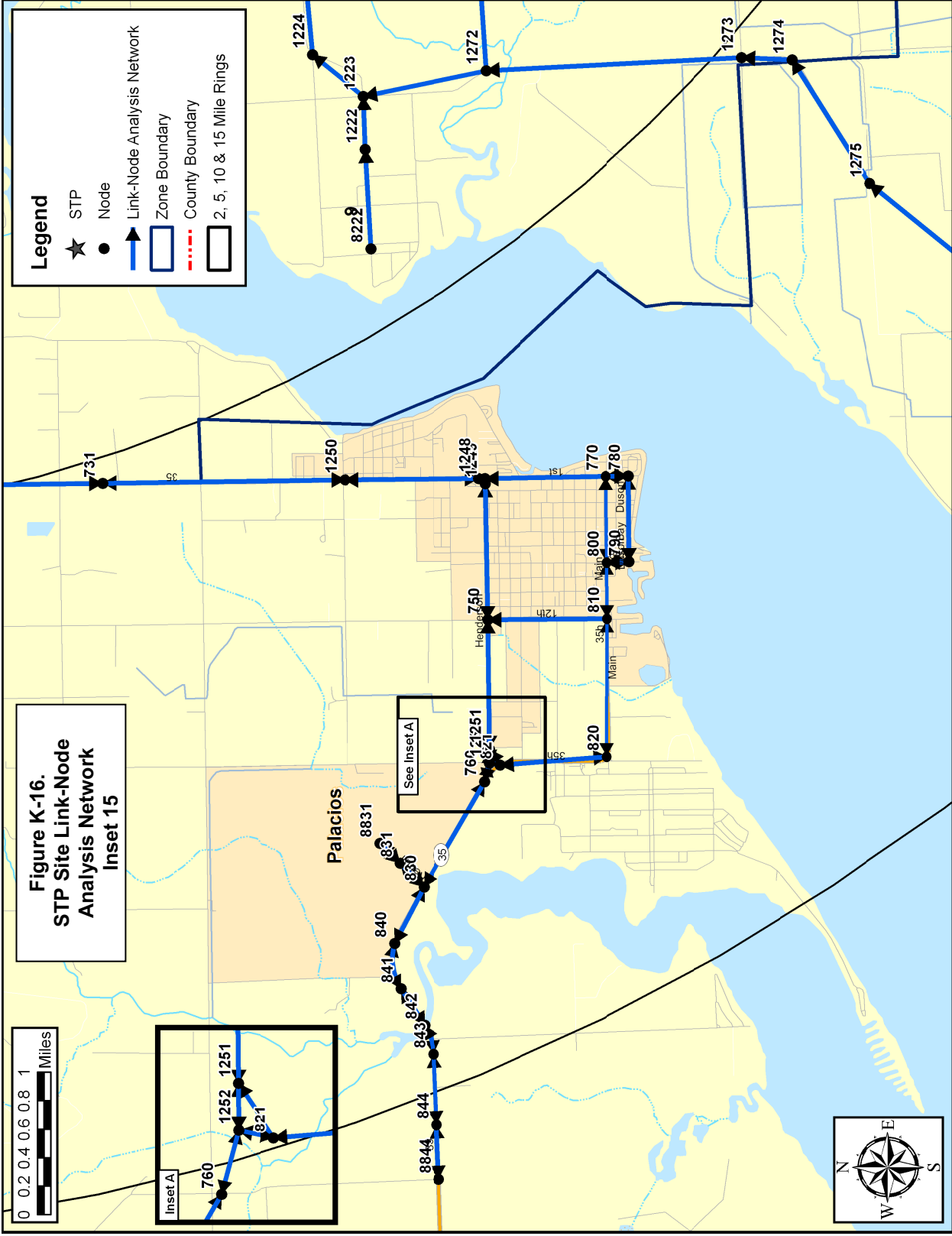




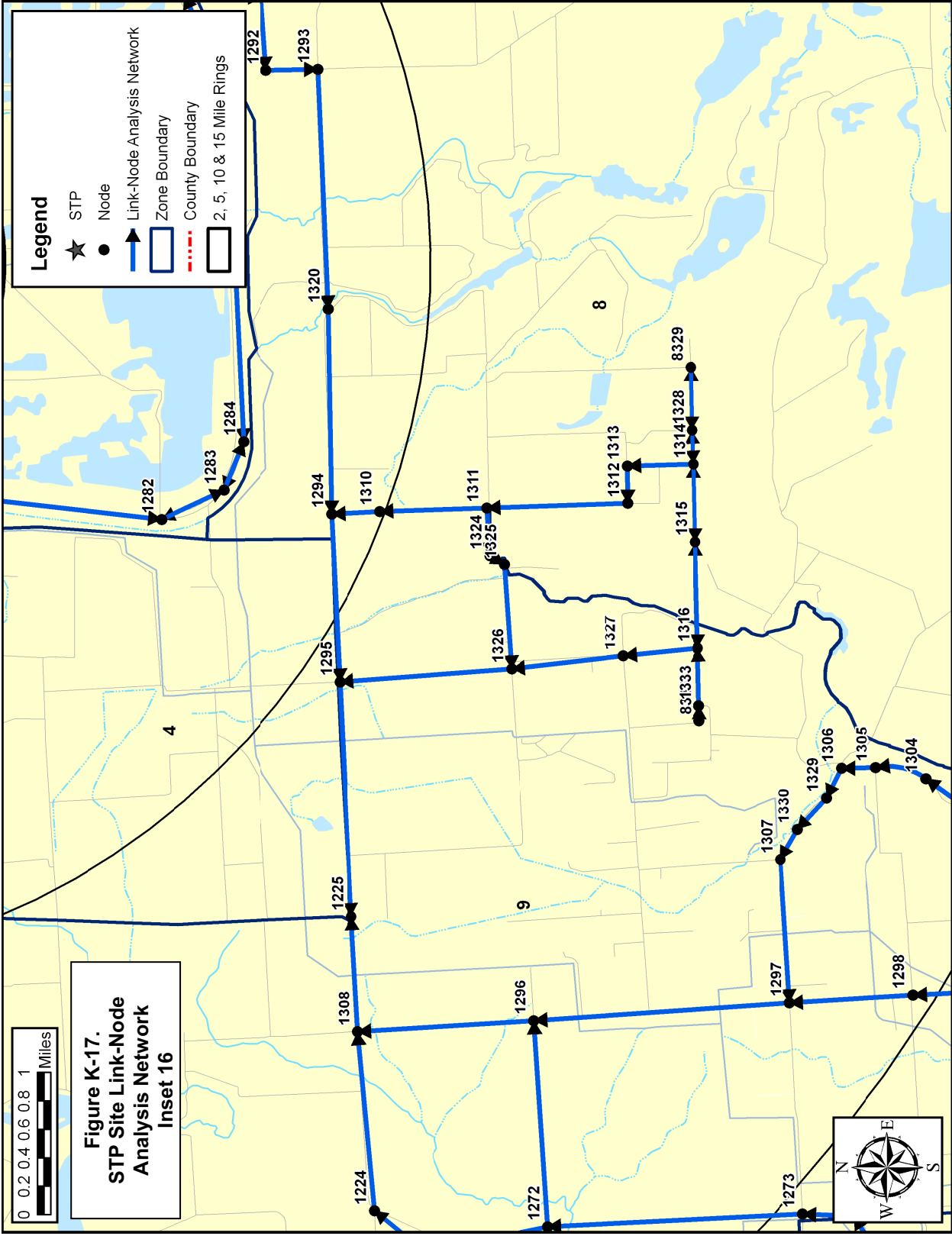


**Figure K-14.**  
**STP Site Link-Node**  
**Analysis Network**  
**Inset 13**









**Figure K-17.**  
**STP Site Link-Node**  
**Analysis Network**  
**Inset 16**

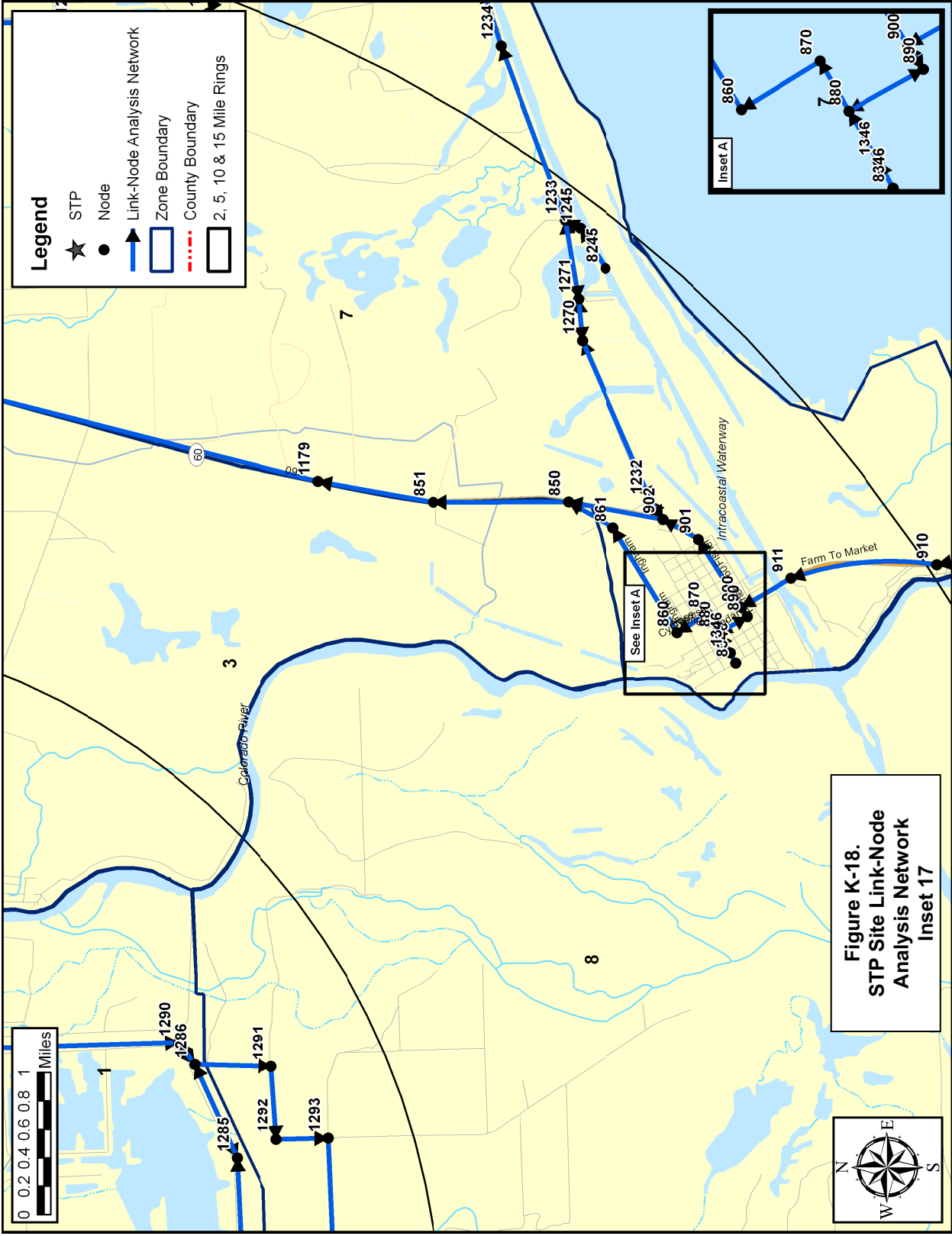
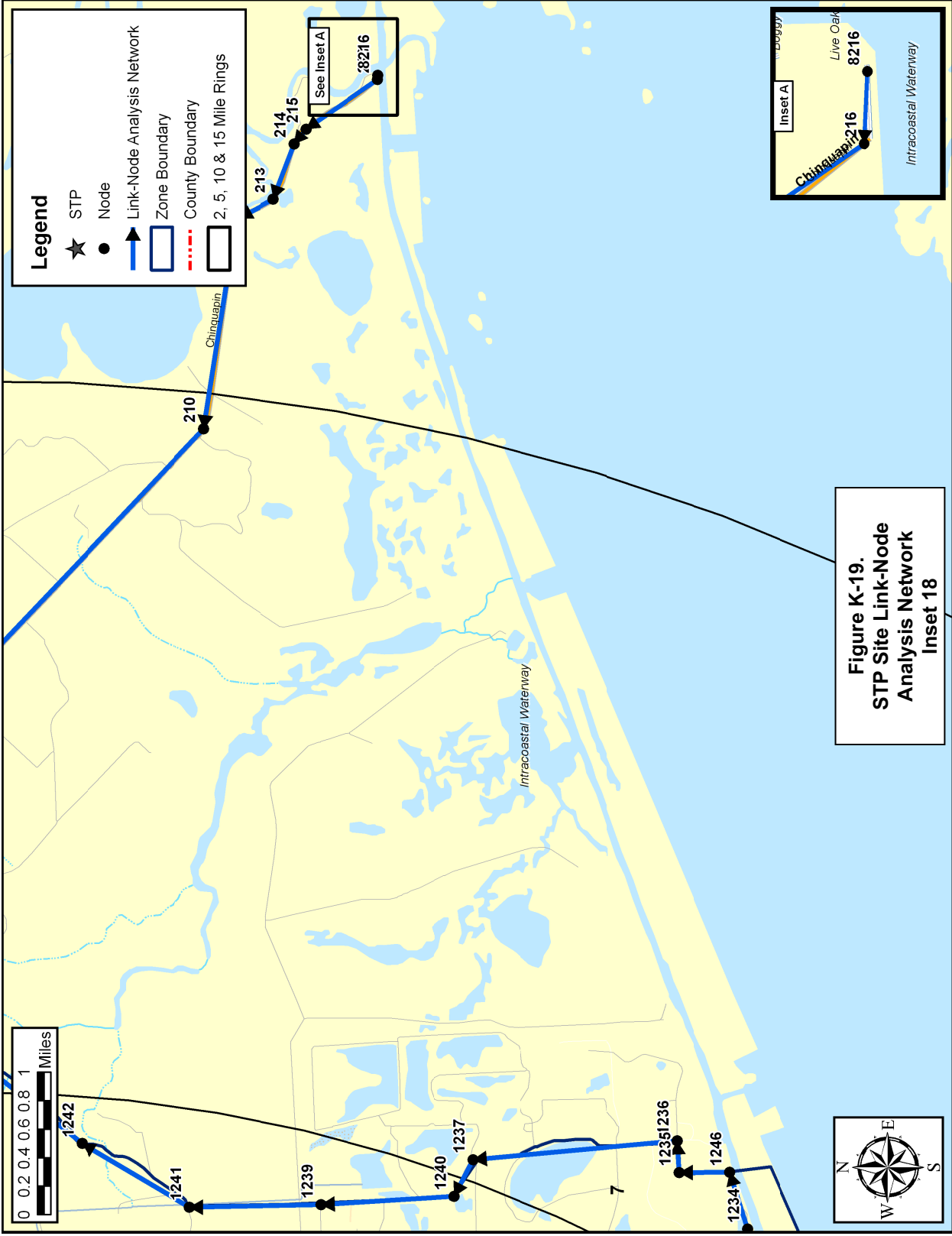


Figure K-18.  
STP Site Link-Node  
Analysis Network  
Inset 17



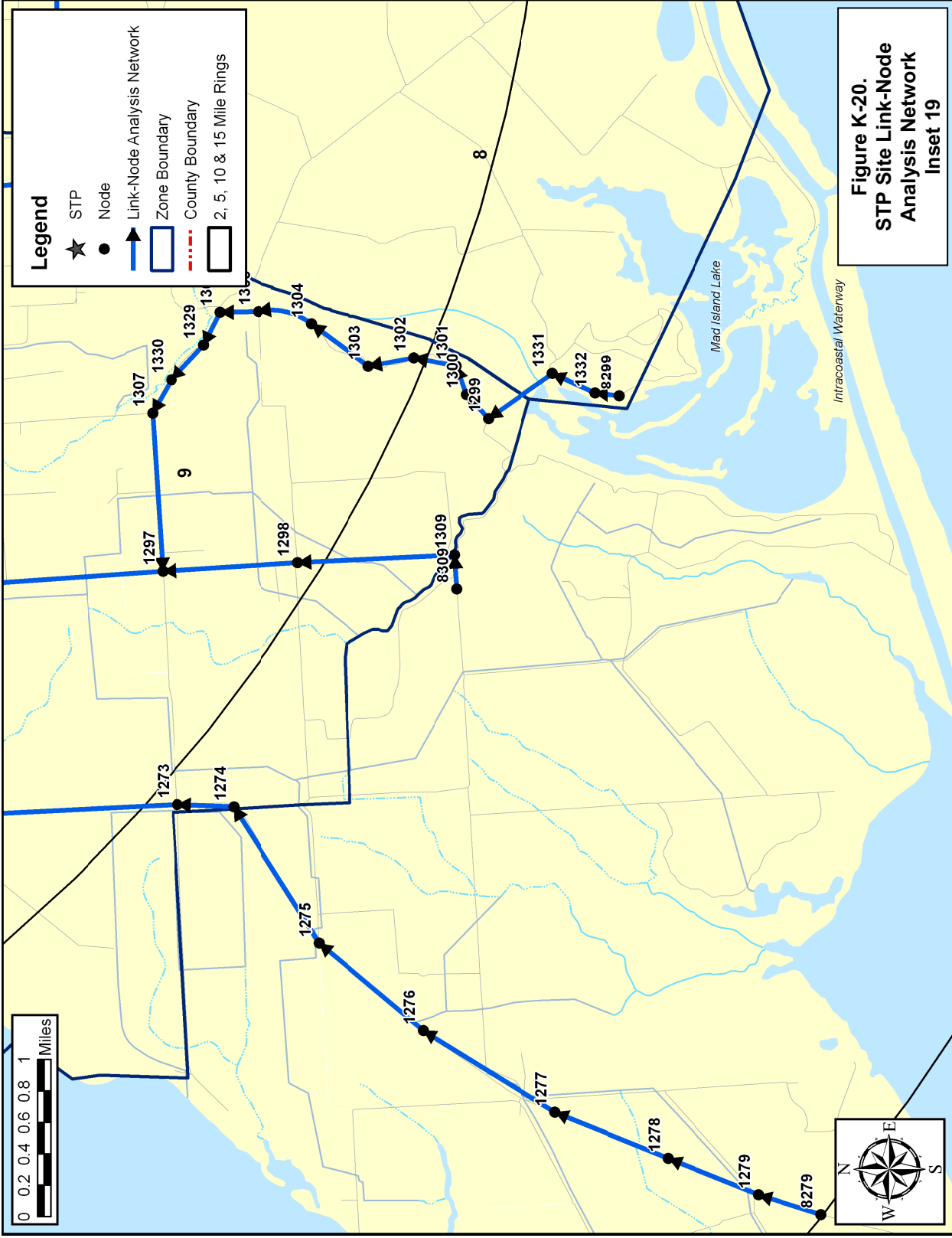
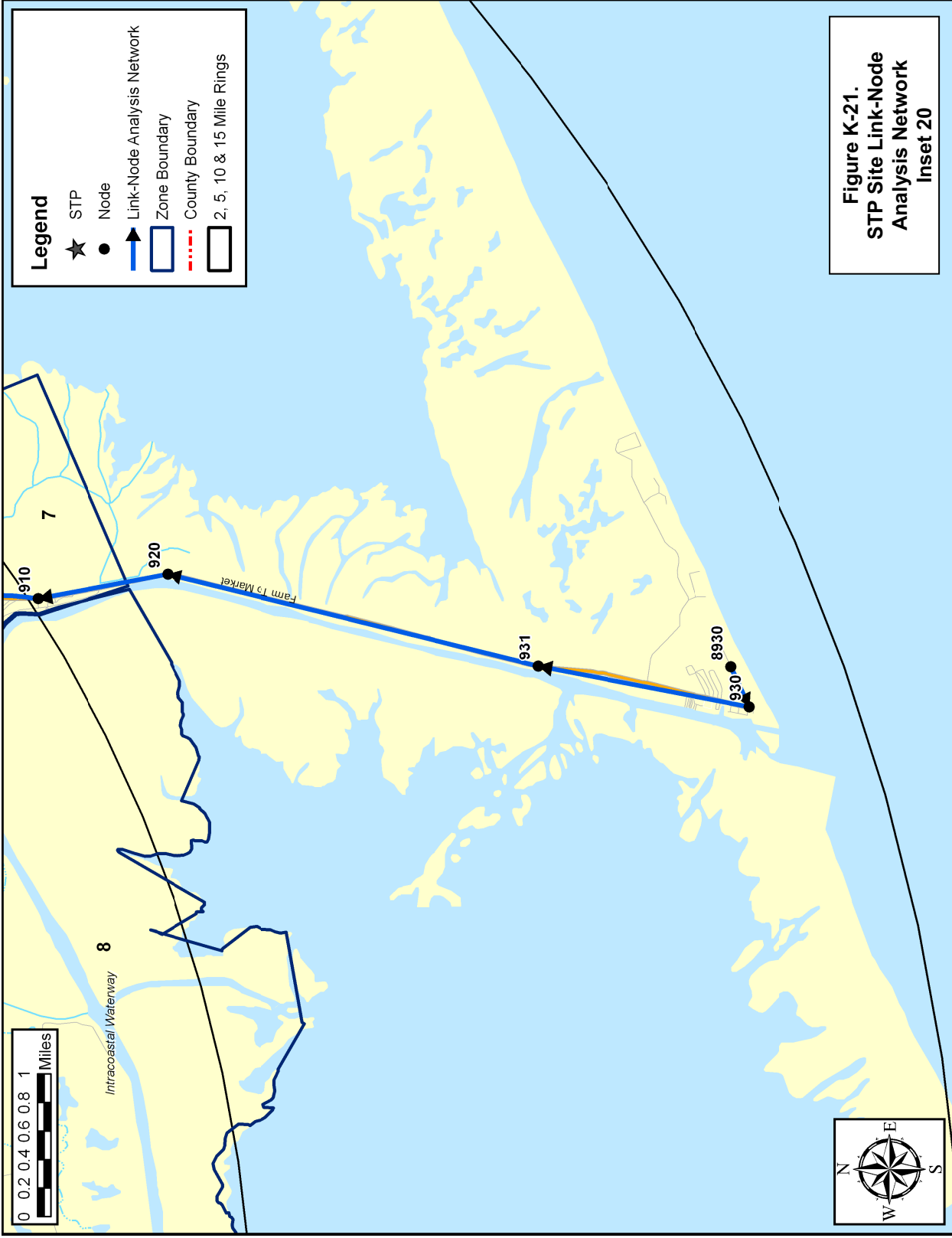


Figure K-20.  
STP Site Link-Node  
Analysis Network  
Inset 19



**Table K-1. Evacuation Roadway Network Characteristics**

<b>Upstream Node Number</b>	<b>Downstream Node Number</b>	<b>Length (miles * 100)</b>	<b>Full Lanes</b>	<b>Saturation Flow Rate (Veh/hr/ln)</b>	<b>Free Flow Speed (MPH)</b>
40	41	111	1	1714	50
40	1133	21	1	1714	50
41	40	111	1	1714	50
41	42	55	1	1714	55
42	41	55	1	1714	50
42	700	71	1	1714	65
50	60	95	1	1714	50
50	1133	42	1	1714	50
60	50	95	1	1714	50
60	61	42	1	1714	50
61	60	42	1	1714	50
61	62	92	1	1714	50
62	61	92	1	1714	50
62	70	49	1	1714	70
70	62	49	1	1714	60
70	71	76	1	1714	70
71	70	76	1	1714	70
71	72	15	1	1714	70
72	71	15	1	1714	70
72	80	12	1	1714	70
80	72	12	1	1714	70
80	81	31	1	1714	70
81	80	31	1	1714	70
81	82	30	1	1714	70
82	81	30	1	1714	70
82	83	74	1	1714	70
83	82	74	1	1714	70
83	84	95	1	1714	65
84	83	95	1	1714	70
84	85	15	1	1714	70
84	1110	102	1	1714	55
85	84	15	1	1714	65
85	86	66	1	1714	70
86	85	66	1	1714	70
86	90	127	1	1714	40
90	86	127	1	1714	70
90	91	16	1	1714	45
91	90	16	1	1714	40
91	92	5	1	1714	45

<b>Table K-1. Evacuation Roadway Network Characteristics</b>					
<b>Upstream Node Number</b>	<b>Downstream Node Number</b>	<b>Length (miles * 100)</b>	<b>Full Lanes</b>	<b>Saturation Flow Rate (Veh/hr/ln)</b>	<b>Free Flow Speed (MPH)</b>
92	91	5	1	1714	45
92	98	67	1	1714	45
93	94	12	1	1714	45
93	98	26	1	1714	45
94	93	12	1	1714	45
94	100	23	1	1714	45
98	92	67	1	1714	45
98	93	26	1	1714	45
100	94	23	1	1714	45
100	101	66	1	1714	45
100	1228	111	1	1714	55
101	110	214	1	1714	55
110	111	15	1	1714	45
111	120	22	1	1714	30
120	121	9	1	1714	35
121	122	38	1	1714	45
122	123	73	1	1714	50
123	130	67	1	1714	55
130	131	61	1	1714	55
131	140	213	1	1714	55
140	141	135	1	1714	55
150	120	79	1	1714	45
161	150	8	1	1714	30
170	161	104	1	1714	45
170	180	43	1	1714	30
180	170	43	1	1714	30
180	1231	38	1	1714	45
190	180	71	1	1714	30
200	190	110	1	1714	50
210	200	323	1	1714	50
211	210	146	1	1714	50
212	211	22	1	1714	50
213	212	29	1	1714	50
214	213	26	1	1714	45
215	214	13	1	1714	45
216	215	60	1	1714	45
220	230	108	1	1714	55
221	1178	77	1	1714	70
230	240	71	2	1714	55
230	250	60	1	1714	55

<b>Table K-1. Evacuation Roadway Network Characteristics</b>					
<b>Upstream Node Number</b>	<b>Downstream Node Number</b>	<b>Length (miles * 100)</b>	<b>Full Lanes</b>	<b>Saturation Flow Rate (Veh/hr/ln)</b>	<b>Free Flow Speed (MPH)</b>
240	241	77	2	1714	55
241	280	87	2	1714	55
242	241	41	1	1500	40
250	260	40	1	1714	50
260	270	206	1	1500	40
270	460	23	1	1714	30
270	1227	25	1	1500	30
280	310	44	2	1500	30
310	320	22	2	1500	30
310	1226	64	1	1500	30
310	1227	77	1	1500	30
320	310	22	2	1500	30
320	340	37	2	1500	40
320	370	21	1	1500	30
320	400	23	1	1500	30
340	320	37	2	1500	30
340	350	42	1	1500	40
350	340	42	1	1500	40
350	990	26	1	1500	40
350	1101	177	1	1714	50
370	320	21	1	1500	30
370	510	44	1	1500	30
400	320	23	1	1500	30
400	430	57	1	1500	30
430	400	57	1	1500	30
430	460	22	1	1714	30
430	1227	23	1	1500	30
460	430	22	1	1500	30
460	461	83	1	1500	30
460	470	76	1	1714	50
461	460	83	1	1714	30
461	1100	41	1	1714	40
470	460	76	1	1714	30
470	480	74	1	1714	65
470	490	141	1	1714	65
480	470	74	1	1714	65
480	481	45	1	1714	65
481	480	45	1	1714	65
490	491	41	1	1714	65
510	370	44	1	1500	30



<b>Table K-1. Evacuation Roadway Network Characteristics</b>					
<b>Upstream Node Number</b>	<b>Downstream Node Number</b>	<b>Length (miles * 100)</b>	<b>Full Lanes</b>	<b>Saturation Flow Rate (Veh/hr/ln)</b>	<b>Free Flow Speed (MPH)</b>
510	1226	22	1	1500	30
510	1266	43	1	1714	45
530	531	21	2	1714	70
530	1265	14	2	1714	70
531	530	21	2	1714	70
531	532	35	2	1500	70
532	531	35	2	1714	70
532	1264	128	2	1500	70
550	560	15	1	1500	30
550	610	30	1	1500	30
550	1263	51	1	1714	40
560	550	15	1	1500	30
560	570	31	1	1500	30
560	590	34	1	1500	30
570	560	31	1	1500	30
570	580	34	1	1500	30
580	570	34	1	1500	30
580	590	30	1	1500	30
590	560	34	1	1500	30
590	580	30	1	1500	30
590	600	32	1	1500	30
590	1344	63	1	1714	50
600	590	32	1	1500	30
600	610	46	1	1500	30
610	550	30	1	1714	30
610	600	46	1	1500	30
610	611	19	1	1714	45
611	612	788	1	1714	60
612	620	45	1	1714	50
620	621	191	1	1714	50
620	622	212	1	1714	50
630	620	131	1	1714	50
640	1168	225	1	1714	70
640	1216	52	1	1714	70
650	651	20	2	1714	65
650	1217	9	2	1714	65
650	1218	8	1	1895	30
651	650	20	2	1714	65
651	652	31	2	1714	60
652	651	31	2	1714	65

<b>Table K-1. Evacuation Roadway Network Characteristics</b>					
<b>Upstream Node Number</b>	<b>Downstream Node Number</b>	<b>Length (miles * 100)</b>	<b>Full Lanes</b>	<b>Saturation Flow Rate (Veh/hr/ln)</b>	<b>Free Flow Speed (MPH)</b>
652	653	76	1	1714	60
653	652	76	1	1895	65
653	660	18	1	1714	50
660	653	18	1	1714	60
660	1267	10	1	1714	50
661	662	362	1	1714	55
661	1269	9	1	1714	50
662	661	362	1	1714	50
662	730	189	1	1800	70
670	1220	167	1	1714	65
680	1189	64	1	1714	65
681	1188	57	1	1714	60
690	681	191	1	1714	60
690	710	139	1	1714	55
691	690	35	1	1714	65
700	42	71	1	1714	65
700	691	217	1	1714	70
710	1190	46	1	1714	50
730	662	189	1	1714	60
730	1338	115	1	1714	70
731	1250	168	1	1714	70
731	1338	133	1	1714	70
740	770	85	1	1714	40
740	1248	6	1	1714	35
740	1249	6	1	1895	30
750	810	84	1	1500	40
750	1249	94	1	1895	40
750	1251	92	1	1714	50
760	830	85	1	1714	55
760	1252	13	1	1714	50
770	740	85	1	1714	70
770	780	15	1	1500	35
770	800	61	1	1500	35
780	770	15	1	1714	40
780	790	60	1	1500	35
790	780	60	1	1500	35
790	800	15	1	1500	35
800	770	61	1	1714	40
800	790	15	1	1500	35
800	810	39	1	1500	40

<b>Table K-1. Evacuation Roadway Network Characteristics</b>					
<b>Upstream Node Number</b>	<b>Downstream Node Number</b>	<b>Length (miles * 100)</b>	<b>Full Lanes</b>	<b>Saturation Flow Rate (Veh/hr/ln)</b>	<b>Free Flow Speed (MPH)</b>
810	750	84	1	1714	30
810	800	39	1	1500	35
810	820	99	1	1714	40
820	810	99	1	1500	40
820	821	79	1	1714	45
821	820	79	1	1714	40
821	1251	9	1	1714	40
821	1252	5	1	1714	40
830	760	85	1	1714	50
830	831	25	1	1714	30
830	840	46	1	1714	55
831	830	25	1	1714	55
840	830	46	1	1714	55
840	841	30	1	1714	40
841	840	30	1	1714	40
841	842	35	1	1714	55
842	841	35	1	1714	55
842	843	21	1	1714	45
843	842	21	1	1714	45
843	844	49	1	1714	55
844	843	49	1	1714	55
850	851	93	1	1714	45
851	1179	80	1	1714	55
852	90	134	1	1714	50
860	861	86	1	1500	35
861	850	39	1	1714	35
870	860	26	1	1500	30
880	870	16	1	1500	30
880	890	25	1	1714	50
890	880	25	1	1500	30
890	900	8	1	1714	50
900	890	8	1	1714	50
900	901	56	1	1714	35
901	902	25	1	1714	35
902	850	74	1	1714	35
902	1232	40	1	1500	45
910	911	98	1	1714	35
911	900	36	1	1714	50
920	910	102	1	1714	45
930	931	151	1	1714	45

<b>Table K-1. Evacuation Roadway Network Characteristics</b>					
<b>Upstream Node Number</b>	<b>Downstream Node Number</b>	<b>Length (miles * 100)</b>	<b>Full Lanes</b>	<b>Saturation Flow Rate (Veh/hr/ln)</b>	<b>Free Flow Speed (MPH)</b>
931	920	269	1	1714	45
940	950	48	1	1500	30
940	970	41	1	1714	45
940	1268	45	1	1714	50
950	940	48	1	1500	30
950	960	39	1	1500	30
960	950	39	1	1500	30
960	970	50	1	1500	30
970	940	41	1	1714	45
970	960	50	1	1500	30
970	971	63	1	1714	50
971	970	63	1	1714	50
971	980	109	1	1714	50
980	971	109	1	1714	50
980	981	96	1	1714	55
980	983	394	1	1714	55
981	980	96	1	1714	50
981	982	123	1	1714	55
982	981	123	1	1714	55
983	980	394	1	1714	50
983	984	122	1	1714	55
984	983	122	1	1714	50
984	1343	60	1	1714	50
990	350	26	1	1500	30
990	1000	48	1	1714	40
1000	990	48	1	1500	40
1000	1100	20	1	1714	40
1100	461	41	1	1500	30
1100	1000	20	1	1714	40
1100	1102	71	1	1714	55
1101	1103	30	1	1714	50
1110	1173	40	1	1714	55
1120	1122	43	1	1714	55
1122	1229	58	1	1714	55
1124	1176	78	1	1714	60
1126	1128	179	1	1714	65
1128	1130	59	1	1714	60
1130	1132	142	1	1714	65
1132	230	118	1	1714	55
1133	40	21	1	1714	50

<b>Table K-1. Evacuation Roadway Network Characteristics</b>					
<b>Upstream Node Number</b>	<b>Downstream Node Number</b>	<b>Length (miles * 100)</b>	<b>Full Lanes</b>	<b>Saturation Flow Rate (Veh/hr/ln)</b>	<b>Free Flow Speed (MPH)</b>
1133	50	42	1	1714	50
1133	1134	31	1	1714	65
1134	1135	42	1	1714	65
1135	1136	30	1	1714	65
1136	1137	20	1	1714	65
1137	1138	56	1	1714	65
1138	1139	20	1	1714	65
1139	1140	40	1	1714	65
1140	1141	38	1	1714	65
1141	1142	32	1	1714	65
1142	1143	5	1	1714	65
1142	1185	29	1	1714	40
1143	1144	45	1	1714	65
1144	1145	35	1	1714	65
1145	1146	29	1	1714	65
1146	1147	28	1	1714	65
1147	1148	49	1	1714	65
1148	1149	27	1	1714	65
1149	1150	9	1	1714	65
1150	1151	57	1	1714	65
1151	1152	22	1	1714	65
1152	1153	11	1	1714	65
1153	1154	43	1	1714	65
1154	1155	62	1	1714	65
1155	1156	17	1	1714	65
1156	1157	45	1	1714	65
1157	1158	31	1	1714	65
1158	1159	53	1	1714	65
1159	1160	30	1	1714	65
1160	1161	53	1	1714	65
1161	1162	17	1	1714	65
1162	1258	46	1	1714	70
1163	1262	25	1	1714	45
1166	1167	157	1	1714	70
1166	1262	74	2	1714	70
1167	1166	157	1	1714	70
1167	1168	140	1	1714	70
1168	640	225	1	1714	70
1168	1167	140	1	1714	70
1169	1170	21	1	1714	30

<b>Table K-1. Evacuation Roadway Network Characteristics</b>					
<b>Upstream Node Number</b>	<b>Downstream Node Number</b>	<b>Length (miles * 100)</b>	<b>Full Lanes</b>	<b>Saturation Flow Rate (Veh/hr/ln)</b>	<b>Free Flow Speed (MPH)</b>
1170	93	33	1	1714	30
1171	1169	39	1	1714	30
1172	1171	71	1	1895	45
1173	1120	116	1	1714	55
1173	1172	69	1	1714	45
1174	1177	91	1	1714	50
1175	1174	58	1	1714	50
1176	1126	38	1	1714	60
1177	1176	96	1	1714	40
1178	220	192	1	1714	70
1179	1238	241	1	1714	65
1180	1181	70	1	1714	50
1180	1187	61	1	1714	45
1181	1180	70	1	1714	50
1181	1182	56	1	1714	30
1182	1181	56	1	1714	50
1182	1186	17	1	1714	30
1183	1184	17	1	1714	30
1183	1186	123	1	1714	50
1184	1183	17	1	1895	30
1184	1185	45	1	1714	40
1185	1142	29	1	1714	30
1185	1184	45	1	1714	40
1186	1182	17	1	1714	30
1186	1183	123	1	1895	50
1187	680	6	1	1714	55
1187	1180	61	1	1714	50
1188	1187	62	1	1714	60
1189	670	87	1	1714	65
1190	1191	16	1	1714	50
1191	1192	171	1	1714	60
1191	1193	51	1	1714	50
1192	730	158	1	1895	40
1193	1191	51	1	1714	40
1193	1194	36	1	1714	55
1194	1193	36	1	1714	50
1194	1195	28	1	1714	55
1195	1194	28	1	1714	55
1195	1196	102	1	1714	55
1196	1195	102	1	1714	55

<b>Table K-1. Evacuation Roadway Network Characteristics</b>					
<b>Upstream Node Number</b>	<b>Downstream Node Number</b>	<b>Length (miles * 100)</b>	<b>Full Lanes</b>	<b>Saturation Flow Rate (Veh/hr/ln)</b>	<b>Free Flow Speed (MPH)</b>
1196	1197	23	1	1714	55
1197	1196	23	1	1714	55
1197	1198	18	1	1714	50
1198	1197	18	1	1714	55
1198	1199	17	1	1714	45
1199	1198	17	1	1714	50
1199	1200	12	1	1714	45
1200	1199	12	1	1714	45
1200	1204	9	1	1714	50
1201	1205	31	1	1714	60
1202	1200	11	1	1500	30
1203	1202	16	1	1500	30
1204	1201	40	1	1714	60
1205	1206	26	1	1714	60
1206	1207	21	1	1714	60
1207	1208	29	1	1714	60
1208	1209	17	1	1714	50
1209	1210	29	1	1714	50
1210	1211	34	1	1714	50
1211	1212	87	1	1714	65
1212	1213	55	1	1714	65
1213	1214	52	1	1714	55
1214	1215	68	1	1714	55
1215	661	39	1	1714	30
1216	640	52	1	1714	70
1216	1217	244	2	1714	65
1217	650	9	2	1714	65
1217	1216	244	2	1714	70
1217	1218	12	1	1895	60
1218	1219	93	1	1714	60
1219	630	167	1	1714	60
1220	640	193	1	1714	40
1221	221	220	1	1714	70
1222	1223	39	1	1500	30
1223	1224	62	1	1500	30
1224	1308	107	1	1714	60
1225	690	356	1	1714	60
1226	310	64	1	1500	30
1226	510	22	1	1500	30
1227	270	25	1	1500	30

<b>Table K-1. Evacuation Roadway Network Characteristics</b>					
<b>Upstream Node Number</b>	<b>Downstream Node Number</b>	<b>Length (miles * 100)</b>	<b>Full Lanes</b>	<b>Saturation Flow Rate (Veh/hr/ln)</b>	<b>Free Flow Speed (MPH)</b>
1227	310	77	1	1500	30
1227	430	23	1	1500	30
1228	100	111	1	1714	45
1228	1221	40	1	1714	55
1229	1124	74	1	1714	60
1229	1230	192	1	1714	40
1230	1228	55	1	1714	40
1231	123	160	1	1714	45
1232	902	40	1	1714	35
1232	1270	101	1	1714	45
1233	1234	129	1	1500	45
1233	1271	69	1	1714	45
1234	1246	30	1	1500	30
1235	1236	18	1	1500	30
1236	1237	142	1	1500	35
1237	1240	30	1	1500	40
1238	852	199	1	1714	55
1239	1241	89	1	1500	45
1240	1239	97	1	1500	45
1241	1242	95	1	1500	45
1242	1243	81	1	1500	45
1243	1244	86	1	1500	45
1244	170	37	1	1500	30
1245	1233	23	1	1714	30
1246	1235	33	1	1500	30
1247	700	43	1	1714	30
1248	740	6	1	1895	30
1248	1249	7	1	1895	30
1248	1250	96	1	1714	70
1249	740	6	1	1895	30
1249	750	94	1	1714	40
1250	731	168	1	1714	70
1250	1248	96	1	1714	60
1251	750	92	1	1714	40
1251	1252	8	1	1714	50
1252	760	13	1	1714	45
1252	821	5	1	1714	40
1252	1251	8	1	1714	50
1258	1163	45	1	1714	50
1261	1263	39	2	1714	70



<b>Table K-1. Evacuation Roadway Network Characteristics</b>					
<b>Upstream Node Number</b>	<b>Downstream Node Number</b>	<b>Length (miles * 100)</b>	<b>Full Lanes</b>	<b>Saturation Flow Rate (Veh/hr/ln)</b>	<b>Free Flow Speed (MPH)</b>
1261	1264	138	2	1500	70
1262	1166	74	2	1714	70
1262	1263	15	2	1714	70
1263	550	51	1	1714	40
1263	1261	39	2	1714	70
1263	1262	15	2	1714	70
1264	532	128	2	1500	70
1264	1261	138	2	1714	70
1265	530	14	2	1714	70
1265	1266	137	2	1714	45
1266	510	43	1	1714	30
1266	1265	137	2	1714	70
1267	1268	12	1	1714	50
1267	1269	13	1	1714	50
1268	940	45	1	1714	45
1268	1269	14	1	1714	45
1269	660	20	1	1714	50
1269	661	9	1	1714	50
1269	1267	13	1	1714	30
1270	1232	101	1	1714	50
1270	1271	29	1	1714	45
1271	1233	69	1	1714	30
1271	1270	29	1	1714	45
1272	1223	74	1	1714	50
1272	1296	155	1	1714	50
1273	1272	188	1	1714	60
1274	1273	44	1	1714	60
1275	1274	89	1	1714	60
1276	1275	86	1	1714	60
1277	1276	102	1	1714	60
1278	1277	79	1	1714	60
1279	1278	59	1	1714	60
1280	1281	50	1	1714	45
1280	1287	77	1	1714	45
1281	1280	50	1	1714	45
1281	1282	205	1	1714	45
1282	1281	205	1	1714	45
1282	1283	44	1	1714	40
1283	1282	44	1	1714	40
1283	1284	39	1	1714	45

<b>Table K-1. Evacuation Roadway Network Characteristics</b>					
<b>Upstream Node Number</b>	<b>Downstream Node Number</b>	<b>Length (miles * 100)</b>	<b>Full Lanes</b>	<b>Saturation Flow Rate (Veh/hr/ln)</b>	<b>Free Flow Speed (MPH)</b>
1284	1283	39	1	1714	40
1284	1285	254	1	1714	45
1285	1284	254	1	1714	45
1285	1286	52	1	1714	40
1286	1285	52	1	1714	45
1286	1290	36	1	1714	40
1286	1291	52	1	1714	30
1287	1280	77	1	1714	45
1287	1288	86	1	1714	45
1287	1336	29	1	1714	35
1288	1287	86	1	1714	45
1288	1289	205	1	1714	45
1288	1334	20	1	1714	30
1289	1288	205	1	1714	45
1289	1290	192	1	1714	45
1290	1286	36	1	1714	40
1290	1289	192	1	1714	45
1291	1292	45	1	1714	30
1292	1293	35	1	1714	30
1293	1320	179	1	1714	50
1294	1295	122	1	1714	50
1295	1225	171	1	1714	50
1296	1308	124	1	1714	50
1297	1296	186	1	1714	50
1298	1297	89	1	1714	60
1299	1300	25	1	1714	40
1300	1301	18	1	1714	45
1301	1302	28	1	1714	45
1302	1303	28	1	1714	45
1303	1304	44	1	1714	45
1304	1305	37	1	1714	45
1305	1306	25	1	1714	45
1306	1329	20	1	1714	45
1307	1297	103	1	1714	50
1308	1225	82	1	1714	50
1309	1298	94	1	1714	60
1310	1294	31	1	1714	45
1311	1310	81	1	1714	50
1311	1324	34	1	1714	40
1312	1311	96	1	1714	45

<b>Table K-1. Evacuation Roadway Network Characteristics</b>					
<b>Upstream Node Number</b>	<b>Downstream Node Number</b>	<b>Length (miles * 100)</b>	<b>Full Lanes</b>	<b>Saturation Flow Rate (Veh/hr/ln)</b>	<b>Free Flow Speed (MPH)</b>
1313	1312	29	1	1714	45
1314	1313	44	1	1714	45
1314	1315	54	1	1714	45
1314	1328	30	1	1714	45
1315	1314	54	1	1714	45
1315	1316	77	1	1714	40
1316	1315	77	1	1714	45
1316	1327	54	1	1714	45
1320	1294	129	1	1714	50
1324	1325	17	1	1714	35
1325	1326	67	1	1714	40
1326	1295	123	1	1714	45
1327	1326	80	1	1714	50
1328	1314	30	1	1714	40
1329	1330	32	1	1714	45
1330	1307	28	1	1714	50
1331	1299	47	1	1714	45
1332	1331	30	1	1714	45
1333	1316	40	1	1714	40
1334	1335	25	1	1714	45
1335	1337	28	1	1714	45
1336	41	51	1	1714	45
1337	61	28	1	1714	45
1338	730	115	1	1714	70
1338	731	133	1	1714	70
1338	1339	148	1	1714	55
1339	1340	181	1	1714	50
1340	1341	21	1	1714	35
1341	1342	195	1	1714	55
1342	1343	114	1	1714	40
1343	984	60	1	1714	50
1343	1347	22	1	1714	50
1344	1345	221	1	1714	50
1346	880	16	1	1500	30
1347	1343	22	1	1714	50

APPENDIX L

Zone Boundaries

## APPENDIX L: Zone Boundaries

### Zone 1

This area includes the site of the South Texas Project. It is defined by the following boundaries:

- East of CR 392
- Southwest of FM 521, with the north western boundary extending over FM 521
- West of the Colorado River
- North of the STP Station southern property boundary

### Zone 2

This is an area generally northeast of the South Texas Project, which includes Celanese. It is defined by the following boundaries:

- East of FM 1468
- South of FM 3057
- West of FM 2668
- North of FM 521

### Zone 3

This is an area generally southeast of the South Texas Project which includes Selkirk Island, Exotic Isle, and Equistar. It is defined by the following boundaries:

- East of the Colorado River and Kelly Lake
- South of FM 521
- West of State Highway (SH) 60
- North of the protection levee at Matagorda

### Zone 4

This is an area generally west of the South Texas Project which includes Tin Top and Citrus Grove Community. It is defined by the following boundaries:

- East of FM 1095
- South of FM 521
- West of CR 392
- North of CR 391

### Zone 5

This is an area generally northwest of the South Texas Project, defined by the following boundaries:

- East of the Tres Palacios River
- South of Wilson Creek
- West of FM 1468
- North of FM 521

#### Zone 6

This is an area generally northeast of the South Texas Project which includes Riverside Park, Hales Acres, and Meadowbrook Estates. It is defined by the following boundaries:

- East of the Colorado River
- South and west of Live Oak Creek
- West of CR 262
- North of FM 521 and FM 3057

#### Zone 7

This is an area generally east and southeast of the South Texas Project which includes the town of Matagorda and the Intracoastal Waterway east of the Colorado River. It is defined by the following boundaries:

- East of SH 60
- South of CR 237 and the protection levee at Matagorda
- West of CR 262, CR241, CR 248, and CR 247 (Chinquapin, Brimstader, Bear Ranch, and North Gulf Roads)
- North of the Intracoastal Waterway

#### Zone 8

This is an area generally south of the South Texas Project defined by the following boundaries:

- East of Mad Island Slough
- South of the STP Station southern property boundary
- West of the Colorado River
- North of West Matagorda Bay

#### Zone 9

This is an area generally southwest of the South Texas Project which includes Collegeport and the northern portion of Tres Palacios Bay. It is defined by the following boundaries:

- East of SH 35
- South of FM 521
- West of FM 1095 and Mad Island Slough
- North of CR 372

#### Zone 10

This is an area generally northwest of the South Texas Project which includes Tidewater Oaks and Tres Palacios Oaks. It is defined by the following boundaries:

- East and south of SH 35
- West of the northern portion of FM 1095 and the Tres Palacios River
- North of FM 521

## Zone 11

This is an area generally north of the South Texas Project which includes El Maton and Buckeye. It is defined by the following boundaries:

- East of the northern portion of FM 1095
- South of SH 35
- West of the northern portion of the Colorado River
- North of Wilson Creek and the 5 mile ring