



**PROPRIETARY INFORMATION**

Figure 1.2-30 – Turbine Building, General Arrangement at Elevation 38300 mm



**PROPRIETARY INFORMATION**

Figure 1.2-31 – Turbine Building, General Arrangement at Elevation 47200 mm



**PROPRIETARY INFORMATION**

Figure 1.2-32 – Turbine Building, General Arrangement at Section A-A



**PROPRIETARY INFORMATION**

Figure 1.2-33 – Turbine Building, General Arrangement at Section B-B



**PROPRIETARY INFORMATION**

Figure 1.2-34 – UHS Tower Plans



**PROPRIETARY INFORMATION**

Figure 1.2-35 – UHS Tower Sections



Figure 1.2-36 – RSW Pumphouse and Tunnel Plans and Sections

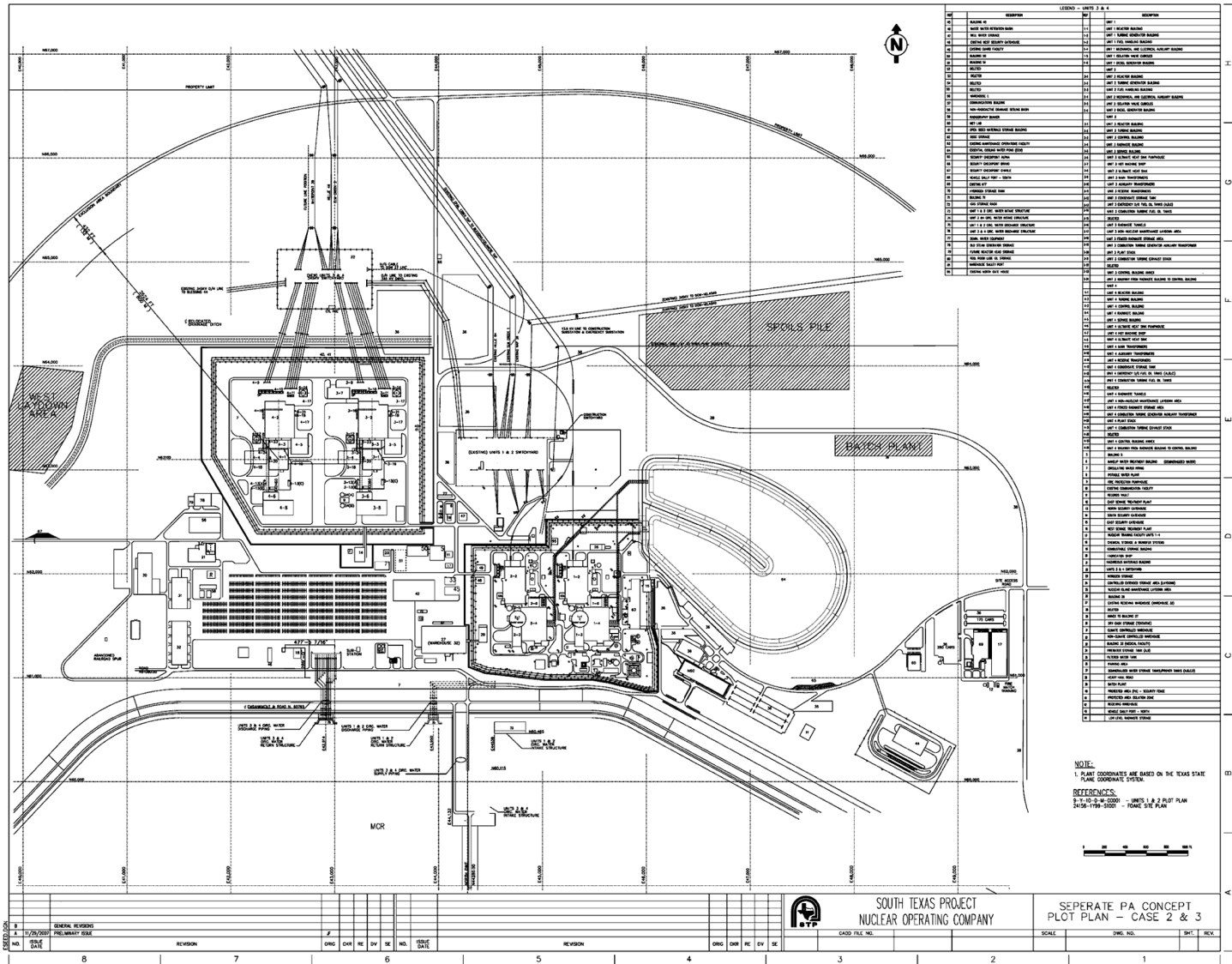

Figure 1.2-37 – Plot Plan



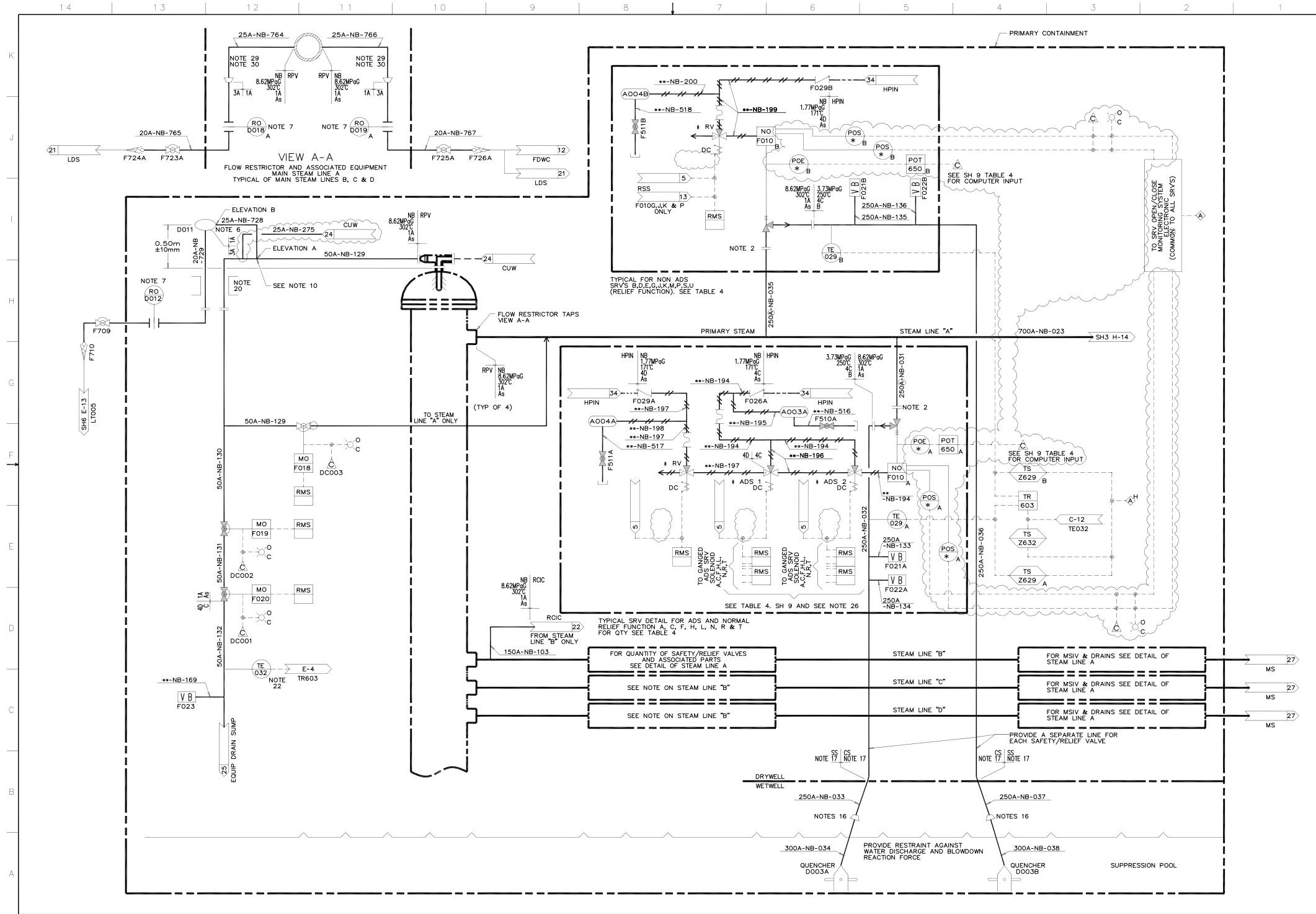

Figure 5.1-3 – Nuclear Boiler System P&ID (Sheet 2 of 11)

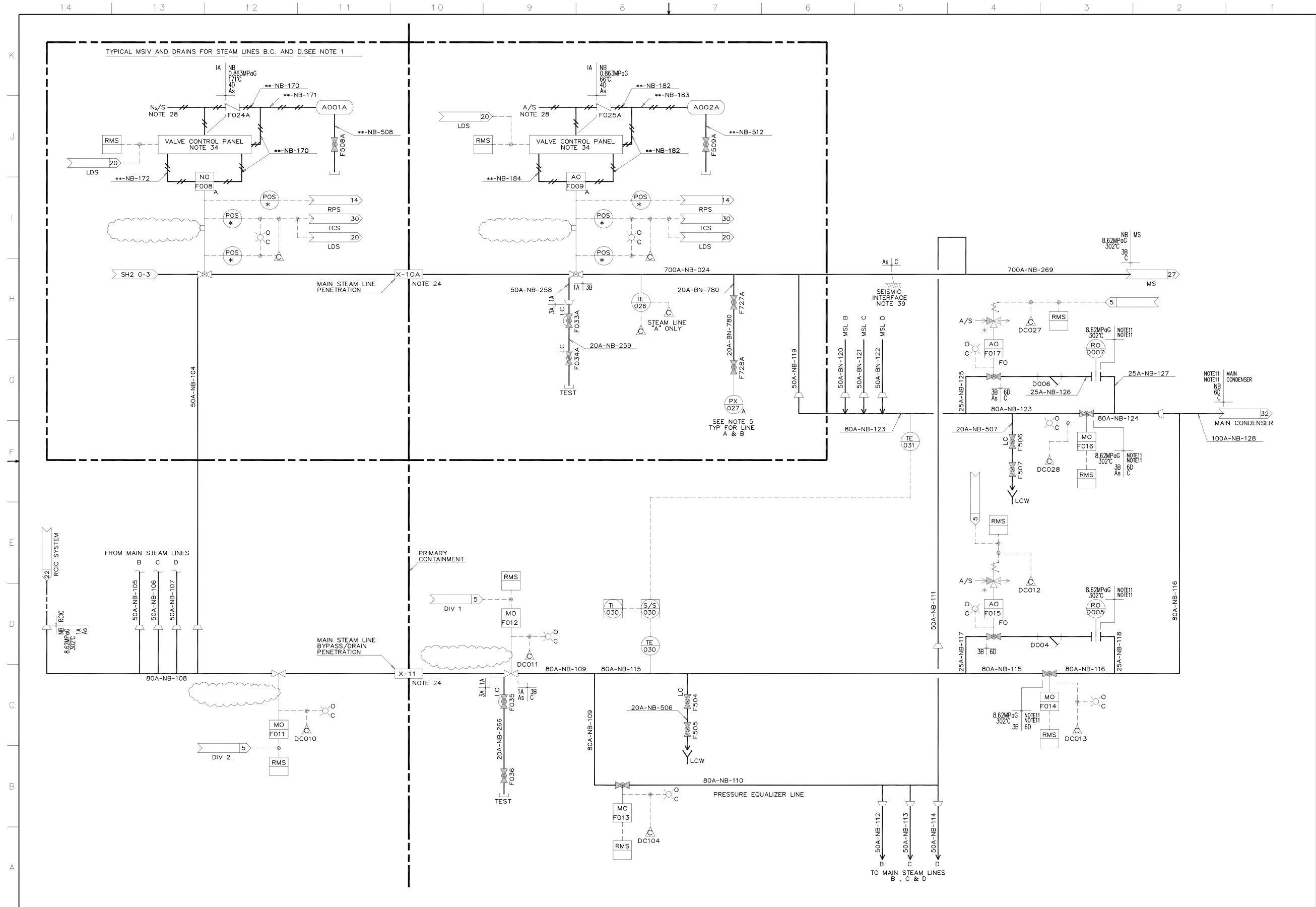

Figure 5.1-3 – Nuclear Boiler System P&ID (Sheet 3 of 11)

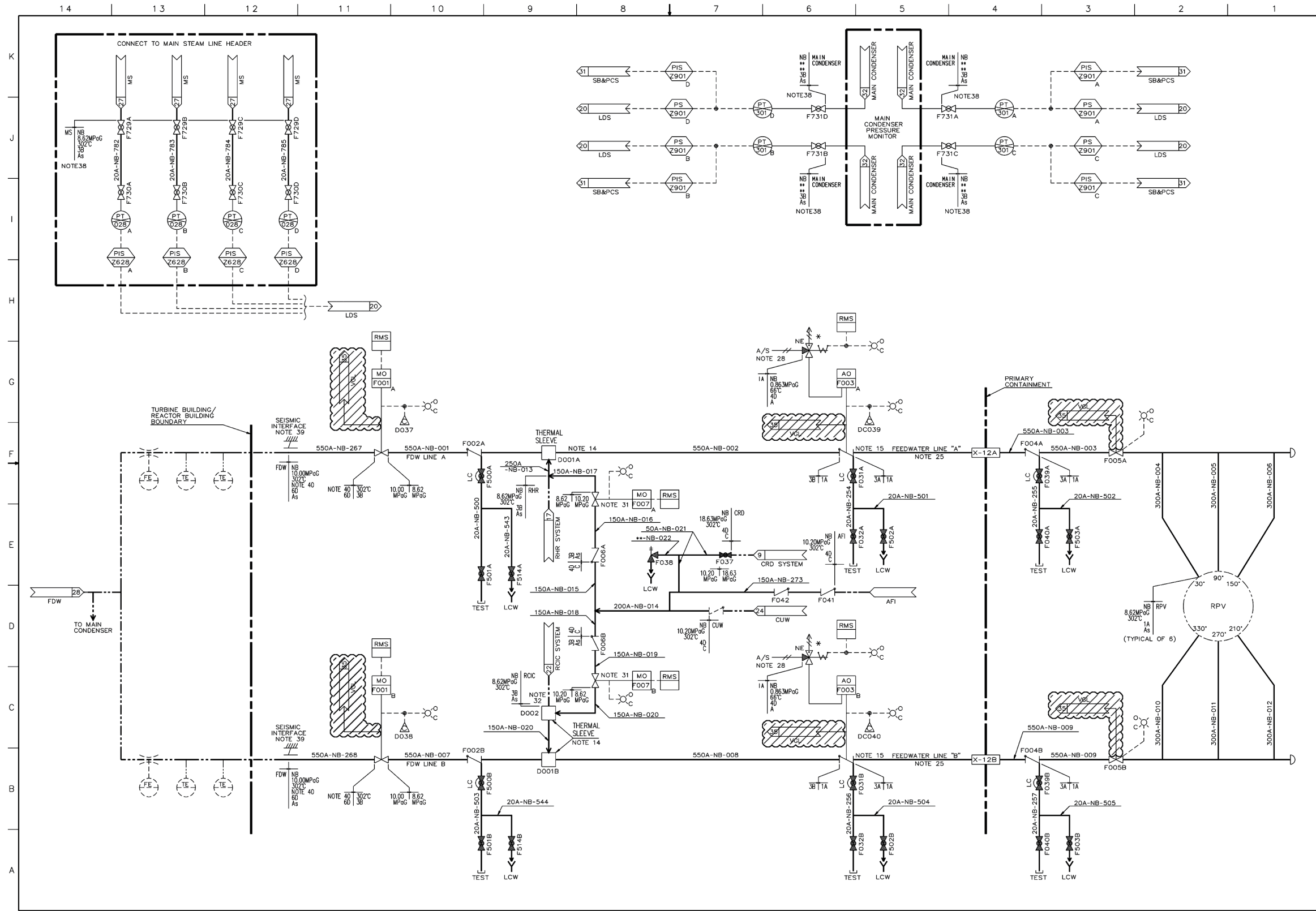

Figure 5.1-3 – Nuclear Boiler System P&ID (Sheet 4 of 11)

TABLE 5: PIPING SPECIFICATIONS		TABLE 5: PIPING SPECIFICATIONS (CONTD)		TABLE 5: PIPING SPECIFICATIONS (CONTD)		TABLE 5: PIPING SPECIFICATIONS (CONTD)		TABLE 5: PIPING SPECIFICATIONS (CONTD)		TABLE 5: PIPING SPECIFICATIONS (CONTD)	
PIPE NO.	SCHEDULE MATERIAL FLUID	PIPE NO.	SCHEDULE MATERIAL FLUID	PIPE NO.	SCHEDULE MATERIAL FLUID	PIPE NO.	SCHEDULE MATERIAL FLUID	PIPE NO.	SCHEDULE MATERIAL FLUID	PIPE NO.	SCHEDULE MATERIAL FLUID
001	** CS W	081	60 SS S	161	80 CS S	241	** SS N	700	80 SS S	780	** CS S
002	** CS W	082	60 SS S	162	80 CS S	242	** SS N	701	** SS W	781	** CS S
003	100 CS W	083	N/A CS S	163	80 CS S	243	** SS N	702	** SS W	782	** SS S
004	100 CS W	084	80 CS S	164	80 CS S	244	** SS N	703	80 SS S	783	** SS S
005	100 CS W	085	60 SS S	165	80 CS S	245	** SS N	704	** SS W	784	** SS S
006	100 CS W	086	60 SS S	166	80 CS S	246	** SS N	705	** SS W	785	** SS S
007	** CS W	087	N/A CS S	167	80 CS S	247	** SS N	706	80 SS S		
008	** CS W	088	60 CS S	168	80 CS S	248	** SS N	707	** SS W		
009	100 CS W	089	60 SS S	169	** CS S	249	** SS N	708	** SS W		
010	100 CS W	090	60 SS S	170	** SS N	250	** SS N	709	80 SS S		
011	100 CS W	091	N/A CS S	171	** SS N	251	** SS N	710	** SS W		
012	100 CS W	092	80 CS S	172	** SS N	252	** SS N	711	** SS W		
013	** CS W	093	60 SS S	173	** SS N	253	** SS N	712	80 SS W		
014	** CS W	094	80 SS S	174	** SS N	254	160 CS W	713	** SS W		
015	** CS W	095	N/A CS S	175	** SS N	255	160 CS W	714	80 SS W		
016	** CS W	096	80 CS S	176	** SS N	256	160 CS W	715	** SS W		
017	** CS W	097	60 SS S	177	** SS N	257	160 CS W	716	80 SS W		
018	** CS W	098	60 SS S	178	** SS N	258	160 CS S	717	** SS W		
019	** CS W	099	N/A CS S	179	** SS N	259	160 CS S	718	80 SS W		
020	** CS W	100	80 CS S	180	** SS N	260	160 CS S	719	** SS W		
021	** CS W	101	60 SS S	181	** SS N	261	160 CS S	720	80 SS W		
022	** CS W	102	80 SS S	182	** SS A	262	160 CS S	721	** SS W		
023	80 CS S	103	120 CS S	183	** SS A	263	160 CS S	722	80 SS W		
024	** CS S	104	160 CS S	184	** SS A	264	160 CS S	723	** SS W		
025	80 CS S	105	160 CS S	185	** SS A	265	160 CS S	724	80 SS W		
026	** CS S	106	160 CS S	186	** SS A	266	** CS S	725	** SS W		
027	80 CS S	107	160 CS S	187	** SS A	267	** CS W	726	80 SS W		
028	** CS S	108	160 CS S	188	** SS A	268	** CS W	727	** SS W		
029	80 CS S	109	** CS S	189	** SS A	269	** CS S	728	** CS S		
030	** CS S	110	** CS S	190	** SS A	270	** CS S	729	** SS W		
031	N/A CS S	111	** CS S	191	** SS A	271	** CS S	730	** SS S		
032	80 CS S	112	** CS S	192	** SS A	272	** CS S	731	** CS S		
033	80 SS S	113	** CS S	193	** SS A	273	** CS S	732	80 SS W		
034	80 SS S	114	** CS S	194	** SS N	274	** SS S	733	** SS W		
035	N/A CS S	115	** CS S	195	** SS N	275	160 CS S	734	80 SS W		
036	80 CS S	116	** CS S	196	** SS N	500	** CS W	735	** SS W		
037	80 SS S	117	** CS S	197	** SS N	501	160 CS W	736	80 SS W		
038	80 SS S	118	** CS S	198	** SS N	502	160 CS W	737	** SS W		
039	N/A CS S	119	** CS S	199	** SS N	503	** CS W	738	80 SS W		
040	80 CS S	120	** CS S	200	** SS N	504	160 CS W	739	** SS W		
041	60 SS S	121	** CS S	201	** SS N	505	160 CS W	740	80 SS W		
042	80 SS S	122	** CS S	202	** SS N	506	** CS S	741	** SS W		
043	N/A CS S	123	** CS S	203	** SS N	507	** CS S	742	80 SS W		
044	80 CS S	124	** CS S	204	** SS N	508	** SS N	743	** SS W		
045	60 SS S	125	** CS S	205	** SS N	509	** SS A	744	80 SS W		
046	60 SS S	126	** CS S	206	** SS N	510	** SS N	745	** SS W		
047	N/A CS S	127	** CS S	207	** SS N	511	** SS A	746	80 SS W		
048	80 CS S	128	** CS S	208	** SS N	512	** SS N	747	** SS W		
049	80 SS S	129	80 CS S	209	** SS N	513	** SS A	748	** SS W		
050	80 SS S	130	80 CS S	210	** SS N	514	** SS N	749	** SS W		
051	N/A CS S	131	80 CS S	211	** SS N	515	** SS A	750	80 SS W		
052	80 CS S	132	** CS S	212	** SS N	516	** SS N	751	** SS W		
053	80 SS S	133	80 CS S	213	** SS N	517	** SS N	752	80 SS W		
054	60 SS S	134	80 CS S	214	** SS N	518	** SS N	753	** SS W		
055	N/A CS S	135	80 CS S	215	** SS N	519	** SS N	754	80 SS W		
056	80 CS S	136	80 CS S	216	** SS N	520	** SS N	755	** SS W		
057	80 SS S	137	80 CS S	217	** SS N	521	** SS N	756	80 SS W		
058	80 SS S	138	80 CS S	218	** SS N	522	** SS N	757	** SS W		
059	N/A CS S	139	80 CS S	219	** SS N	523	** SS N	758	80 SS W		
060	80 CS S	140	80 CS S	220	** SS N	524	** SS N	759	** SS W		
061	60 SS S	141	80 CS S	221	** SS N	525	** SS N	760	80 SS W		
062	60 SS S	142	80 CS S	222	** SS N	526	** SS N	761	** SS W		
063	N/A CS S	143	80 CS S	223	** SS N	527	** SS N	762	80 SS W		
064	80 CS S	144	80 CS S	224	** SS N	528	** SS N	763	** SS W		
065	80 SS S	145	80 CS S	225	** SS N	529	** SS N	764	** SS S		
066	80 SS S	146	80 CS S	226	** SS N	530	** SS N	765	** SS W		
067	N/A CS S	147	80 CS S	227	** SS N	531	** SS N	766	** SS S		
068	80 CS S	148	80 CS S	228	** SS N	532	** SS N	767	** SS W		
069	80 SS S	149	80 CS S	229	** SS N	533	** SS N	768	** SS S		
070	80 SS S	150	80 CS S	230	** SS N	534	** SS N	769	** SS W		
071	N/A CS S	151	80 CS S	231	** SS N	535	** SS N	770	** SS S		
072	80 CS S	152	80 CS S	232	** SS N	536	** SS N	771	** SS W		
073	80 SS S	153	80 CS S	233	** SS N	537	** SS N	772	** SS S		
074	60 SS S	154	80 CS S	234	** SS N	538	** SS N	773	** SS W		
075	N/A CS S	155	80 CS S	235	** SS N	539	** SS N	774	** SS S		
076	80 CS S	156	80 CS S	236	** SS N	540	** SS N	775	** SS W		
077	80 SS S	157	80 CS S	237	** SS N	541	** SS N	776	** SS S		
078	80 SS S	158	80 CS S	238	** SS N	542	** CS S	777	** SS W		
079	N/A CS S	159	80 CS S	239	** SS N	543	** CS W	778	** SS S		
080	80 CS S	160	80 CS S	240	** SS N	544	160 CS W	779	** SS W		

Figure 5.1-3 Nuclear Boiler System P&ID (Sheet 10 of 11)

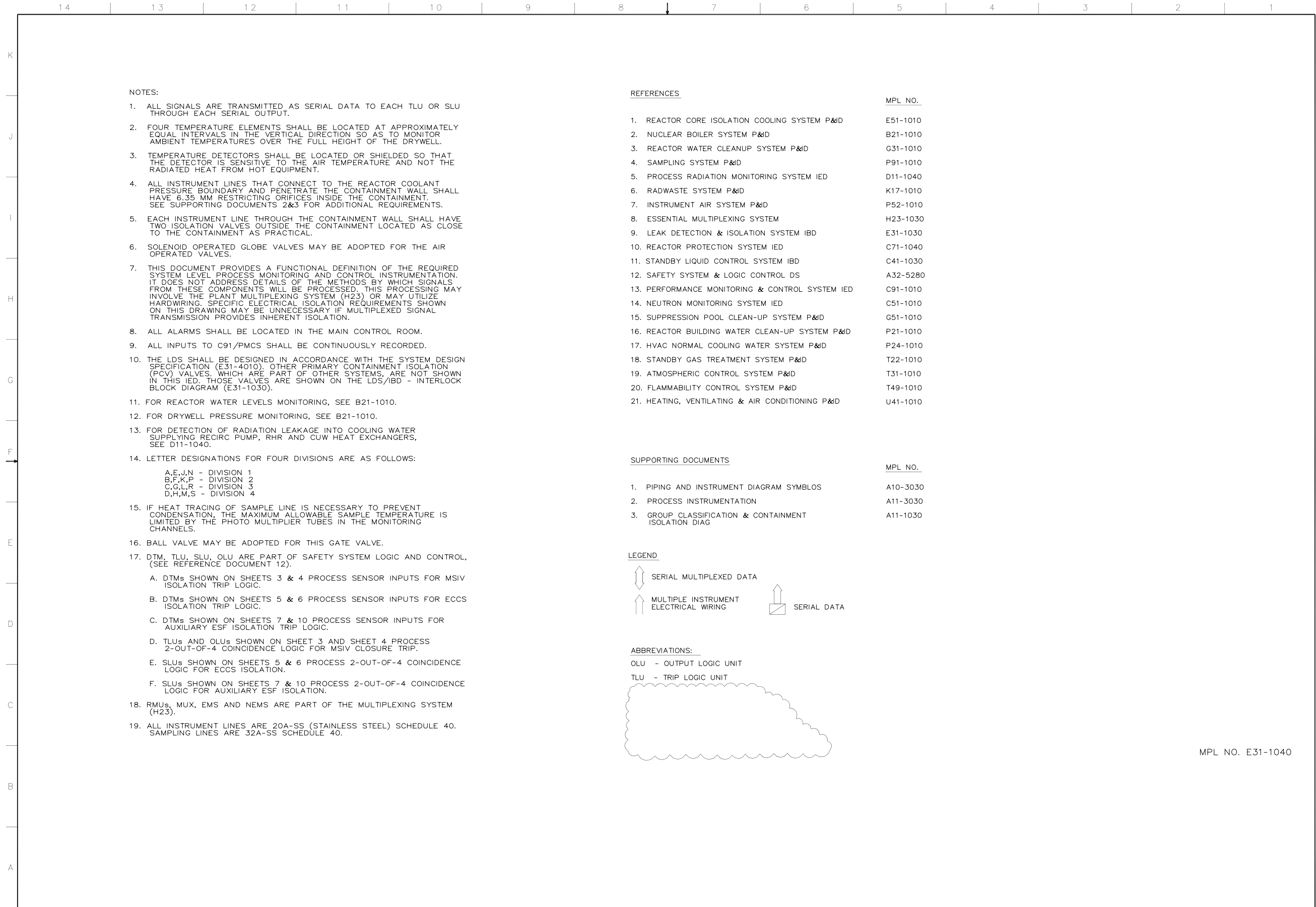

Figure 5.2-8 – Leak Detection and Isolation System IED (Sheet 1 of 10)

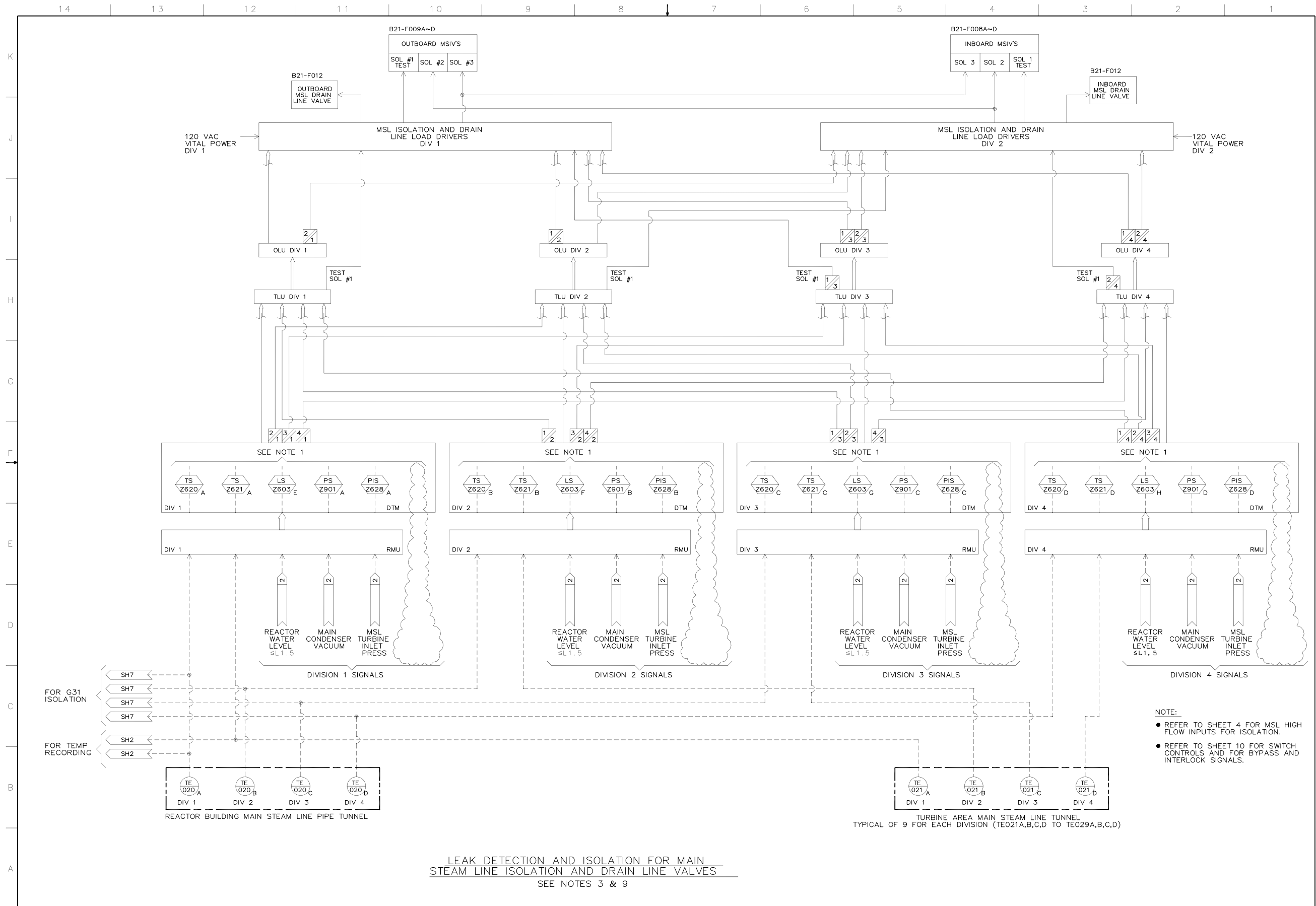

Figure 5.2-8 – Leak Detection and Isolation System IED (Sheet 3 of 10)

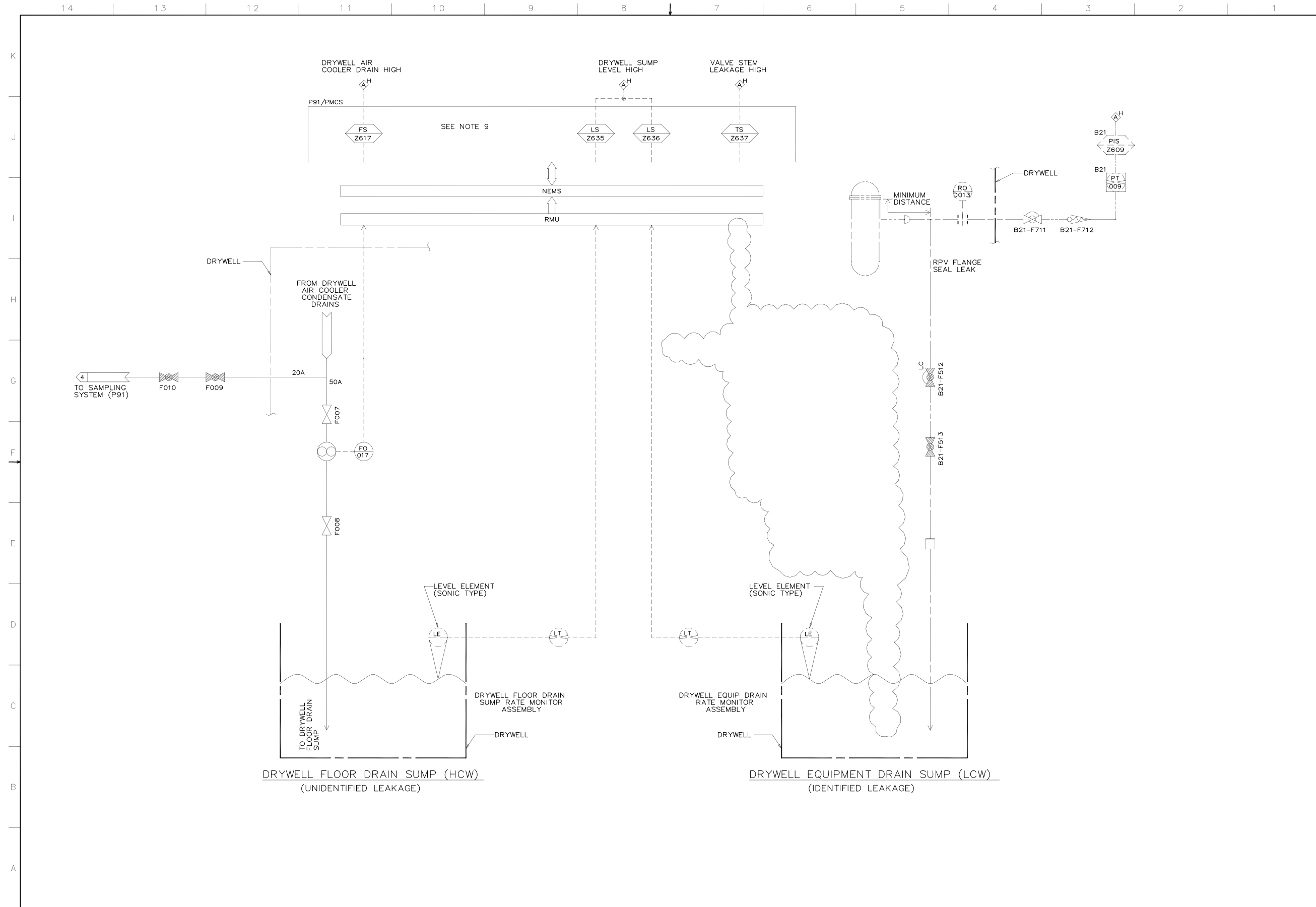

Figure 5.2-8 – Leak Detection and Isolation System IED (Sheet 8 of 10)

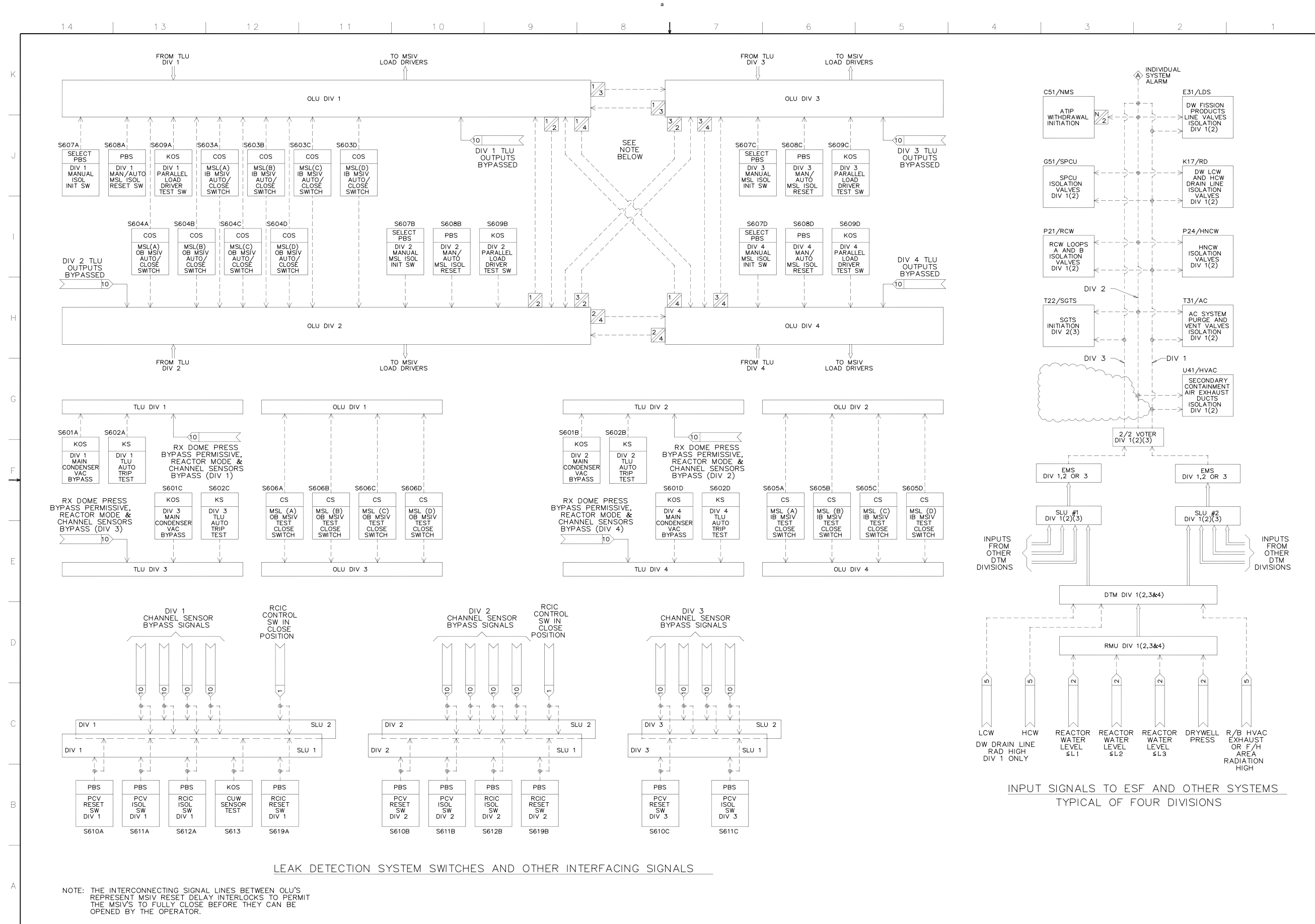

Figure 5.2-8 – Leak Detection and Isolation System IED (Sheet 10 of 10)