

### 3A Seismic Soil Structure Interaction Analysis

The information in the appendix of the reference ABWR DCD, including all subsections, tables, and figures, is incorporated by reference with the following site-specific supplement.

#### 3A.12 Site-Specific SSI Analysis

In accordance with the requirements of Section 3.7.1 and 3.7.2 of NUREG-0800, a site specific soil-structure interaction (SSI) analysis has been performed using the site-specific soil properties and site-specific SSE ground motion, to confirm that the standard plant SSI analysis results included in the DCD envelop the results of the site-specific SSI.

#### 3A.13 Applicable Documents

##### 3A.13.1 Codes and Standards

ASCE 4-98: ASCE Standard for Seismic Analysis of Safety Related Nuclear Structures, 1998.

##### 3A.13.2 Regulatory Requirements

- RG 1.60 "Design Response Spectra for Seismic Design of Nuclear Power Plants"
- RG 1.61 "Damping Values for Seismic Design of Nuclear Power Plants"
- RG 1.92 "Combining Modal Response and Spatial Components in Seismic Response Analysis"
- RG 1.122 "Development of Floor Design Response Spectra for Seismic Design of Floor-Supported Equipment or Components"
- NUREG-0800 "USNRC Standard Review Plan for Review of Safety Analysis Reports for Nuclear Power Plants Light Water Reactor Edition"

#### 3A.14 Structural Outline

The Reactor Building (RB) and Control Building (CB) are safety related and Seismic Category I structures. The RB is integrated with the Reinforced Concrete Containment Vessel (RCCV), which is monolithic with the RB slabs. The CB is a reinforced concrete box like structure. The key plan and section of RB and CB are shown in Figures 3A-229 and 3A-230, respectively.

In modeling the buildings, the 0°-180° and 90°-270° directions are designated as X and Y axes, respectively. The Z axis is in the vertical direction.

#### 3A.15 Site Conditions

SSI analyses were performed using the STP 3 & 4 site-specific soil properties. Both RB and CB are founded on in-situ soil. Soil backfill is used only adjacent to the walls. The site-specific shear wave velocities are provided in FSAR Table 2.5S.4-27.

The strain-compatible soil properties for the SSI model were obtained from the same models and ground response analysis which were used to develop the GMRS, as described in Section 2.5S.2.5. A set of mean strain-compatible shear wave velocity and damping values, along with the associated standard deviations, was calculated. The calculated properties and associated standard deviations were used to develop the best estimate (BE), upper bound (UB), and lower bound (LB) profiles. While the BE profile is the mean profile, the UB and LB profiles are the mean +/- one standard deviation, respectively, maintaining the minimum variation of 1.5 on soil shear modulus, per the guidance provided in SRP 3.7.2. The corresponding compression wave velocity (VP) profiles were calculated using the shear wave velocity and the Poisson's ratio. The resulting strain-compatible properties for the three profiles are presented in Table 3H.6-1.

The backfill used along the walls of the structure will be granular soil compacted to 95% Modified Proctor. Based on this, the backfill modulus and damping values were calculated as described in Section 3H.6.5.2.4. Based on the following analysis, it was concluded that the effect of the backfill is considered to be bounded by the variation in soil properties used in the analysis.

Based on the calculated strain-compatible backfill properties, as explained in Section 3H.6.5.2.4, Figure 3A-230a presents a comparison of the strain compatible backfill shear wave velocities (from Table 3H.6-2), strain compatible in-situ soil shear wave velocities (from Table 3H.6-1), and strain compatible shear wave velocities for the UB1D150 (and VP3D150) case from DCD, Appendix 3A. Similarly, Figure 3A-230b shows a comparison between the backfill damping profile, in-situ soil damping profile and UB1D150 and VP3D150 cases from DCD, Appendix 3A.

For Figure 3A-230a, the strain-compatible soil properties for DCD – UB1D150 and VP3D150 were obtained from the free-field response analysis of the UB1D150 and VP3D150 soil profiles provided in Table 3A-2 of the DCD. The free-field response analysis was performed using strain-dependent shear modulus and damping values provided in DCD Tables 3A-3 and 3A-4, respectively. The DCD soil profile was analyzed using two horizontal time histories, each compatible with the 0.3g Regulatory Guide R.G. 1.60 response spectra, applied at the ground surface. The strain compatible soil properties for the DCD – UB1D150 and VP3D150 cases, shown in Figure 3A-230a, are an average of the strain compatible soil properties obtained from these two analyses. The free-field response analysis was performed using computer program SHAKE2000.

Based on the comparisons shown in Figures 3A-230a and 3A-230b, the following is concluded:

- The lower bound backfill shear wave velocities are, in general, higher than the lower bound in-situ soil properties (Figure 3A-230a). A small variation to this observation in the upper few feet and lower few feet is not significant in light of the overall trend of the comparison over the entire depth of the backfill. Therefore, the SSI analysis performed for the lower bound in-situ soil properties bounds the higher properties of the backfill material.

- The upper bound backfill shear wave velocities are, in general, higher than the upper bound in-situ soil shear wave velocities (Figure 3A-230a). Therefore, the SSI analysis performed for the upper bound in-situ soil properties does not bound the upper bound properties of the backfill. However, the upper bound backfill shear wave velocity case is enveloped by the VP3D150 Soil Profile. Since the DCD soil profile was used for the Reactor and Control Buildings design, it is concluded that a separate analysis including the upper bound backfill shear wave velocity is not required.
- The damping values for lower bound, mean and upper bound in-situ soil profiles are in general lower than the damping values for the corresponding lower bound, mean and upper bound backfill profiles.

The estimated material damping for lower-bound (LB) backfill is 3%. The material damping for LB in-situ soil varies in the range of about 1.67% to 3.1%, in general being around 2.25%. The low damping of about 1.67% is in the top four feet of soil depth. The use of backfill material damping may result in somewhat higher motion at the foundation level as compared to the use of the in-situ soil material damping, but the difference in the foundation level motions due to difference in the two damping values (i.e. 3% for backfill and 2.25% for in-situ soil) will be very small. Furthermore, in the Soil Structure Interaction analysis, because of much higher radiation damping (generally higher than 20% for horizontal and vertical motions, as demonstrated in NUREG/CR-5956, "Consideration of Uncertainties in Soil-Structure Interaction Computations", prepared by C.J. Costantino and C.A. Miller), the small difference in the material damping will have insignificant effect on the final responses.

To further demonstrate that the higher damping in the backfill material for lower bound case will not result in foundation motions that exceed those of DCD, free-field SHAKE2000 analyses have been performed for lower bound backfill profile with 3% damping (with site specific Safe Shutdown Earthquake (SSE) input motion applied at grade) and DCD UB1D150 strain compatible soil profile (with 0.3g R.G. 1.60 input motion at grade). The Reactor Building (RB) and Control Building (CB) foundation level response spectra obtained from the two analyses were compared. The comparisons were made for both outcrop and in-profile motions. The comparisons showed that the DCD foundation motions exceed the corresponding foundation motions obtained from lower bound backfill with 3% damping.

Based on the above it is concluded that the strain-compatible shear modulus and damping properties of the backfill material are bounded by the lower-bound and upperbound in-situ soil properties (or the DCD soil properties in case of upper bound shear modulus).

Based on the site groundwater conditions originally described in FSAR Subsection 2.4S.12, the groundwater elevation of approximately eight feet below grade (26 feet MSL) was used in the analysis to determine the soil properties. Subsection 2.4S.12 and Table 2.0-2 now state the groundwater elevation as 28 feet MSL. Therefore, a sensitivity analysis of this change in groundwater elevation was performed using the

Diesel Generator Fuel Oil Storage Vault SSI model, which showed no significant effect on the analysis results.

The groundwater effect was included in the analysis by modifying the compression wave velocity,  $V_p$ , such that it is not less than 5000 ft/sec, except where Poisson's ratio,  $\nu$ , calculated from the following Equation (1) is higher than 0.48. In those cases,  $\nu$  is set to the maximum value of 0.48 and  $V_p$  is re-calculated using Equation (2).

$$\nu = \frac{1(5000/V_s)^2 - 2}{2(5000/V_s)^2 - 1} \leq 0.48 \quad \text{Equation (1)}$$

$$V_p = V_s \sqrt{\frac{2 - 2\nu}{1 - 2\nu}} \quad \text{Equation (2)}$$

### 3A.16 Input Motion and Damping Values

#### 3A.16.1 Design Response Spectra

The site-specific horizontal and vertical SSE ground motion response spectra (GMRS) were developed for the site as discussed in FSAR Section 2.5S.2. A comparison of the GMRS with the DCD SSE response spectra is shown in Figure 3A-231 for horizontal direction and in Figure 3A-232 for vertical direction.

In addition to the GMRS, Foundation Input Response Spectra (FIRS) were also developed at the free field foundation elevation of the RB and CB, using the same probabilistic models and analyses which were used for developing the GMRS. A detailed description of the seismic wave transmission of the site, and the procedure used to calculate the GMRS, which is the same for the development of FIRS, is provided in FSAR Sections 2.5S.2.5 and 2.5S.2.6, respectively.

For the site-specific SSI analysis, free field ground surface response spectra (Input Spectra) were developed, in the horizontal and vertical directions, to satisfy the following requirements:

- (a) The Input Spectra shall envelop the GMRS. See Figures 3H.6-1 and 3H.6-2 showing that the Input Spectrum envelops the GMRS in the horizontal and vertical directions, respectively.
- (b) When a deconvolution analysis is performed in the SHAKE program with the Input Spectrum applied at the free field ground surface, the resulting response spectrum at the outcrop of the RB and CB foundation shall envelop the FIRS. See Figures 3A-233 through 3A-250 for a comparison of the outcrop response spectra, resulting from the application of the time histories consistent with the Input Spectra at the free field ground surface in SHAKE, and the FIRS for the RB and CB foundations, in the two horizontal and vertical directions for the mean,

upper bound and lower bound soil properties. These figures show that the FIRS are enveloped by the foundation outcrop spectra in all cases.

- (c) The response spectrum at the SHAKE outcrop of the RB and CB shall envelop a broad band spectrum anchored at 0.1g. This is the minimum requirement as stated in SRP 3.7.1 and Appendix S to 10 CFR 50, "Earthquake Engineering Criteria for Nuclear Power Plants". The broad band spectrum used in the analysis is conservatively defined as the Regulatory Guide 1.60 spectrum anchored at 0.1g. See Figures 3A-233 through 3A-250, which demonstrate that this requirement is met for the RB and CB foundations, in the horizontal and vertical directions.

The Input Spectra discussed above, which will be used as the site-specific SSE design response spectra (see FSAR Section 3.7.1), are compared with the DCD SSE design response spectra in Figures 3A-231a and 3A-232a for horizontal and vertical directions, respectively, for 5% damping.

### 3A.16.2 Design Time Histories

Synthetic acceleration time histories consistent with the Input Spectra defined and discussed in Subsection 3A.16.1 were developed, using the 1952 Taft earthquake time history as the seed, for use as input to the SSI analysis. A single set of time histories (two horizontal and one vertical) was developed satisfying the enveloping requirements of Option 1, Approach 2 of SRP 3.7.1, Section II.1B, Revision 3. Per paragraph 2(d) of Approach 2, in lieu of the power spectrum density requirement, the requirement that the computed 5% damped response spectrum of the artificial time history does not exceed the target response spectrum at any frequency by more than 30% was met. In the time history method of analysis, the two horizontal and the vertical time histories were applied separately (not simultaneously) and the maximum responses were combined using the square-root-of-the-sum-of-the-squares (SRSS) or the 100-40-40 percent spatial combination rule. Therefore, per Regulatory Guide 1.92, Revision 2, statistical independence of the three time histories (cross-correlation coefficient requirement) is not required.

Figures 3A-251 through 3A-259 show the plots of acceleration, velocities, and displacement time histories in the two horizontal and vertical directions. The strong motion durations for the X-horizontal direction, Y-horizontal direction, and vertical are 11.2 sec, 11.2 sec, and 12.2 sec, respectively, which meet the minimum duration requirement of six seconds specified in SRP 3.7.1.

Figures 3H.6-12 through 3H.6-14 show the comparison of the response spectra for the synthetic time history, the Input Spectrum, and 1.3 times the Input Spectrum, in the two horizontal and vertical directions for 5% damping.

As described in Section 3H.8, since DCD does not include digitized SSE time histories, synthetic time histories consistent with the DCD SSE Response Spectra shown in Figures 3A-231 and 3A-232 were developed for seismic analysis of the Diesel Generator Fuel Oil Storage Vaults and the Diesel Generator Fuel Oil Tunnels. Acceleration time history records obtained from 1994 Northridge Earthquake were

used as seed time histories in generating these synthetic time histories. Both sets of synthetic time histories, one for the DCD SSE response spectra and the other for the site-specific SSE response spectra, meet SRP 3.7.1.2 requirements, although they are based on seed time histories from different earthquakes. Since the seed time histories are modified to produce response spectra consistent with the target spectra, and because those spectra are used for linear elastic analyses, it is unlikely that the use of seed time histories from different earthquake would have resulted in materially different results.

### 3A.16.3 Percentage of Critical Damping Values

The percentages of critical damping values considered in the SSI analysis for the RB and CB structures are in accordance with the criteria defined in Regulatory Guide 1.61. Since the site-specific SSE is lower than the DCD SSE, the stress levels in the structures will be smaller than the code allowables. Therefore, in accordance with the guidance of Regulatory Guide 1.61, damping values specified for the OBE were used in the analysis.

The strain-compatible, soil damping values considered in the analysis are shown in Table 3H.6-1 for various soil layers.

### 3A.17 Supporting Media for Seismic Category 1 Structures

Soil conditions at the STP 3 & 4 site are described in Subsection 2.5S.4. The soil at the site extends down several thousand feet and consists of alternating layers of clay, silt, and sand.

The approximate characteristic dimensions of the RB and CB are summarized below:

Structure	Embedment Depth to Bottom of Basemat (ft)	Maximum Height from Bottom of Basemat (ft)	Base Dimensions (ft)
Reactor Building	84	208	186 x 196
Control Building	76	111	184 x 79

### 3A.18 Soil-Structure Interaction Analysis Method

The linear finite element computer program SASSI2000 was used for the SSI analysis. The program uses finite elements with complex modules for modeling the structure and foundation properties. The method used is based on the Flexible Volume Direct Method and the frequency domain complex response analysis. The lumped mass-beam model is coupled with finite element soil model. The model details are described in Section 3A.19. Structural responses in terms of accelerations, forces, and moments, are computed directly. Floor response spectra are obtained from the calculated response acceleration time histories.

The SSI analyses for the three directional earthquake components are performed separately. The maximum co-directional responses to each of the three earthquake components are combined as described in Section 3A.16.2.

### 3A.19 Analysis Models

The RB and CB models are three-dimensional lumped mass-beam models that consider shear, bending, and axial deformations.

#### 3A.19.1 Outline of Structural Model

The RB is modeled by multiple stick models that represent the RB, RCCV and pedestal/Reactor Shield wall. The building model is coupled to the Reactor Pressure Vessel (RPV). The RPV is symmetric in both horizontal directions. These stick models are interconnected by horizontal links representing the floor diaphragm at respective elevations. These links are modeled as stiff springs for floor in-plane translational displacement. The CB is represented by a single stick.

The RB seismic models are shown in DCD Figures 3A-8 through 3A-11. The models for CB are shown in DCD Figures 3A-27 and 3A-28.

The floor flexibility in the vertical direction is modeled by including single degree of freedom oscillations in the stick model at major floor locations.

To obtain the mass properties for the stick model, the dead load, and 25% of the respective live load (75% for the roof) were used to compute the lumped masses. The dead load included weight of structures, equipment, and commodities such as piping, cable trays, etc.

Based on the methodology described above, the lumped mass-beam stick model for SSI analysis was developed as described in Section 3A.19.2.

#### 3A.19.2 SSI Model for SASSI2000 Analysis

In the SASSI2000 model, the exterior walls below grade and the foundation basemat along with the supporting soil medium are modeled. For this reason, the sectional properties of the stick model are modified to subtract the stiffness properties corresponding to subgrade and outer walls. In this model, the basemat and the exterior walls are modeled by plate elements.

The stick model is connected to the basemat and sidewalls at ground floor level and basemat floors by a set of rigid links.

The SASSI2000 soil model included soil down to a minimum of two times the maximum plan dimension of the building below the basemat. The bottom boundary of the model was considered to have an elastic half space condition. The soil properties used for the SASSI2000 model are described in Section 3A.15.

The SSI model of the RB is a quarter model taking advantage of double symmetry. The model is shown in Figure 3A-263. Figure 3A-264 shows the composite soil and structural model. Similarly Figures 3A-265 and 3A-266 show the CB SSI models.

### 3A.20 Analysis Results

Site-Specific SSI analysis results of STP 3 & 4 are compared with the DCD envelop results in terms of acceleration response spectra and seismic forces. The response spectra in two horizontal directions were enveloped to compare with the DCD design horizontal response spectra.

#### 3A.20.1 RB SASSI2000 Analysis Result

The results in terms of accelerations and forces are compared in Tables 3A-29 and 3A-30. As shown in this table, the DCD results envelop the STP 3 & 4 site-specific results.

The results in terms of broadened acceleration response spectra at typical locations are compared in Figures 3A-267 through 3A-292. As shown in these figures, the DCD results envelop the STP 3 & 4 site-specific results for all frequencies above 0.2 Hz.

#### 3A.20.2 CB SASSI2000 Analysis Result

The results in terms of accelerations and forces are compared in Tables 3A-31 and 3A-32. As shown in this table, the DCD results envelop the STP 3 & 4 site-specific results.

The results in terms of broadened acceleration response spectra at typical locations are compared in Figures 3A-293 through 3A-298. As shown in these figures, the DCD results envelop the STP 3 & 4 site-specific results for all frequencies above 0.2 Hz.

### 3A.21 Soil Pressure on Reactor and Control Building Walls Considering Structure-to-Structure Interaction (SSSI) Effect

To evaluate the effect of SSSI on soil pressures on the RB and CB walls, two dimensional (2D) analyses of RB and CB individually, and 2D SSSI analyses of RB and CB together with Turbine Building (TB) were performed using SASSI2000 software using the subtraction method of analysis. For resolution of issues with the subtraction method of analysis identified by the Defense Nuclear Facilities Safety Board (DNFSB) see Section 3H.10. Since the RB and CB and non-category I TB are closely spaced in the North-South (N-S) direction, the SSSI analysis was performed in the N-S direction. Both the RB and CB were analyzed individually in the N-S direction. The Soil-Structure Interaction (SSI) analysis was repeated for (1) the RB+CB model and (2) the RB+CB+TB model to consider the SSSI effects. The results of these analyses were enveloped. The 2D models used for these analyses are similar to the models described in DCD Tier 2, Section 3A.9.7 for considering SSSI effect on the RB and CB and soil pressures on the building walls. For soil properties variation effects, each analysis was performed using three site-specific SSE strain-compatible in-situ soil conditions: upper bound, mean and lower bound, and the results were enveloped. The sitespecific SSE input motion is defined at the grade elevation.

The details of the N-S direction structural part of the SSI model of the RB + CB, and RB + CB + TB are shown in Figures 3A-299 and 3A-300, respectively. In these figures, the elevation 39.37 feet corresponds to finished grade elevation of 12.00 meter TMSL noted in DCD, which corresponds to STP finished grade elevation of 34 feet MSL.



The RB is idealized by a center-line stick model of a series of massless beam elements representing the building walls, Reinforced Concrete Containment Vessel (RCCV), Reactor Shield Wall (RSW)/Pedestal and Reactor Pressure Vessel (RPV). Similar to the three dimensional model, the center-line stick model consists of three individual sticks, one for RB walls, one for RCCV and one for RSW/Pedestal with RPV supported on it. Axial, flexural, and shear deformation effects are included in beam elements properties. Coupling between individual structures is modeled by linear spring elements. Masses, including dead weights of the structural elements, equipment weights and piping weights, are lumped to nodal points. The weights of water in the spent fuel storage pool and the suppression pool are also considered and lumped to appropriate locations. The basemat and the mudmat are modeled by 4-node plain strain elements. To properly transfer the rotation of the stick model to the basemat (and vice-versa), a set of rigid beams are placed at the top of the basemat connecting each stick to its respective footprint. The stick representing the outer walls of the RB is connected to the side walls in horizontal directions by a set of rigid beams to reflect the direct connect condition of outside wall with the soil. The soil adjacent to the building is modeled by 4-node plane strain elements. The structural model properties (stiffness and mass) for the 2D model correspond to per unit depth (1 foot dimension in the out-of-plane direction) of the RB.

The CB is idealized by beam elements with lumped masses located at each floor elevation. The side walls are modeled with beam elements, which provide shear rigidity in the N-S direction. The basemat and the mudmat are modeled by 4-node plain strain elements. To properly transfer the rotation of the stick model to the base slab (and vice-versa), a set of rigid beams are placed at the bottom of the basemat connecting the stick to its footprint. The stick representing the walls is connected to cross walls in the horizontal direction by a set of axially rigid beams to reflect the direct contact condition of the outside wall with the soil. The soil adjacent to the building is modeled by 4-node plane strain elements. The structural model properties (stiffness and mass) for the 2D model correspond to per unit depth (1 foot dimension in the out-of-plane direction) of the CB.

The TB model consists of two concentric lumped-mass sticks representing the building structures and the turbine generator pedestal. The simple representation is sufficient since the TB representation is only to evaluate its effect on the CB and RB. Similar to the RB and CB 2D models, the structural model properties (stiffness and mass) of the TB correspond to per unit depth in the E-W direction.

Figures 3A-301 and 3A-302 provide the soil pressure profiles between the RB and CB obtained from SSSI analysis for site-specific Safe Shutdown Earthquake (SSE) along with the design soil pressures reported in DCD Table 3A-18 and Figures 3H.1-11 and 3H.2-14. As can be seen from these figures, the soil pressure profiles from the SSSI analysis are bounded by the envelope of the certified design soil pressures from DCD Table 3A-18 and Figures 3H.1-11 and 3H.2-14 with one exception. The soil pressure from the SSSI analysis for the CB slightly exceeds the certified design soil pressure at a depth of about 26 to 30 feet below the ground surface. At all other elevations the DCD soil pressures are higher than the site-specific soil pressure. Therefore, the total force due to the certified design soil pressure on the wall panel above or below it will be

significantly higher than the total force due to soil pressure from the SSSI analysis. Therefore, the design based on certified design soil pressures is adequate.

### **3A.22 Conclusion**

The SSI analyses were performed using the STP 3 & 4 site soil properties. It was confirmed that the DCD seismic forces, moments, accelerations, and response spectra bound the results of the STP 3 & 4 site-specific SSI analysis.

Table 3A-29 Comparison of Reactor Building DCD and STP 3&amp;4 Seismic Forces

Element No.	DCD Max. Shear (t)	STP 3&4 Max. Shear (t)	DCD Max. Moment (MN-m)	STP 3&4 Max. Moment (MN-m)	DCD Max. Torsion (MN-m)	STP 3&4 Max. Torsion (MN-m)
93	8,700	1,118	1,471.05	143.80	254.98	32.67
94	19,000	2,386	2,942.10	345.86	539.39	69.72
96	25,000	3,971	5,295.78	705.69	715.91	116.04
98	35,000	5,868	7,159.11	1,040.68	1,078.77	171.49
99	40,000	7,492	9,316.65	1,481.59	1,176.84	218.94
100	53,000	10,871	13,729.80	2,274.00	1,569.12	317.68
101	53,000	13,191	16,671.90	3,109.09	1,569.12	385.50
102	53,000	14,731	20,594.70	4,041.43	1,569.12	430.48
87	9,500	2,764	1,471.05	249.05	74.53	21.68
88	23,000	2,910	2,353.68	255.72	362.86	47.08
89	25,000	3,294	3,824.73	471.90	402.09	53.31
90	25,000	3,519	5,688.06	735.50	402.09	56.94
91	25,000	5,248	7,257.18	1,060.29	402.09	84.92
92	26,000	6,924	8,826.30	1,477.67	421.70	112.04
74	80	11	2.06	0.30	0.39	0.06
75	630	68	10.79	1.24	3.33	0.36
76	700	82	20.59	2.38	3.73	0.43
77	980	164	36.29	5.03	5.10	0.86
78	1,100	178	53.94	7.91	5.49	0.93
79	2,400	619	107.88	32.35	16.67	4.25
80	2,700	924	156.91	54.17	18.63	6.34
81	2,700	966	215.75	77.71	18.63	6.63
103	2,700	1,004	245.18	87.51	18.63	6.89
82	2,800	1,029	294.21	105.68	19.61	7.06
83	2,942	1,078	343.25	125.53	20.59	7.40
84	2,942	1,109	402.09	146.51	20.59	7.61
85	3,040	1,152	470.74	175.81	21.58	7.91
86	3,138	1,211	588.42	217.16	21.58	8.31
28	420	75	29.42	4.33	1.57	0.10
69	1,200	241	69.63	11.48	9.61	0.50

Note: Please refer to DCD Figures 3A-8 and 3A-10 for location of element numbers. The DCD values are taken from DCD Tables 3A-19a through 3A-19d.

Table 3A-30 Comparison of Reactor Building DCD and STP 3&amp;4 Maximum Accelerations

Node	Elev. TMSL (m)	Location	DCD Max. Horizontal Acceleration (g)	STP 3&4 Max. Horizontal Acceleration (g)	DCD Max. Vertical Acceleration (g)	STP 3&4 Max. Vertical Acceleration (g)
95	49.70	R/B	1.44	0.20	1.03	0.20
96	38.20	R/B	1.10	0.16	0.83	0.16
98	31.70	R/B	0.93	0.15	0.80	0.15
100	23.50	R/B	0.75	0.14	0.63	0.14
102	18.10	R/B	0.59	0.14	0.50	0.14
103	12.30	R/B	0.47	0.13	0.39	0.13
104	4.80	R/B	0.32	0.13	0.33	0.13
105	-1.70	R/B	0.31	0.12	0.32	0.13
88	-8.20	R/B	0.31	0.11	0.33	0.13
107	31.70	R/B Floor	-	-	1.20	0.15
108	23.50	R/B Floor	-	-	1.55	0.15
109	18.10	R/B Floor	-	-	1.84	0.19
110	12.30	R/B Floor	-	-	1.02	0.27
111	4.80	R/B Floor	-	-	0.54	0.39
112	-1.70	R/B Floor	-	-	0.46	0.31
89	31.70	RCCV	0.96	0.15	0.82	0.15
90	23.50	RCCV	0.82	0.14	0.95	0.16
91	18.10	RCCV	0.65	0.14	0.89	0.15
92	12.30	RCCV	0.55	0.13	0.77	0.14
93	4.80	RCCV	0.48	0.13	0.56	0.13
94	-1.70	RCCV	0.36	0.12	0.38	0.13
88	-8.20	RCCV	0.31	0.11	0.33	0.13
70	21.20	RSW/PED	1.02	0.15	0.55	0.13
78	18.44	RSW/PED	0.92	0.14	0.55	0.13
79	17.02	RSW/PED	0.83	0.14	0.55	0.13
80	15.60	RSW/PED	0.73	0.14	0.52	0.13
81	13.95	RSW/PED	0.63	0.14	0.52	0.13

**Notes:**

- (1) For Node numbers, refer to DCD Figures 3A-8 and 3A-10.
- (2) DCD acceleration values are taken from DCD Tables 3A-23a through 3A-23d.
- (3) Horizontal accelerations are the envelopes of X and Y direction responses.

**Table 3A-30 (Cont.)  
Comparison of Reactor Building DCD and STP 3&4 Maximum Accelerations**

Node	Elev. TMSL (m)	Location	DCD Max. Horizontal Acceleration (g)	STP 3&4 Max. Horizontal Acceleration (g)	DCD Max. Vertical Acceleration (g)	STP 3&4 Max. Vertical Acceleration (g)
82	12.30	RSW/PED	0.58	0.13	0.51	0.13
71	8.20	RSW/PED	0.55	0.13	0.49	0.13
83	7.00	RSW/PED	0.53	0.13	0.49	0.13
72	4.50	RSW/PED	0.50	0.12	0.43	0.13
84	3.50	RSW/PED	0.50	0.12	0.41	0.13
73	1.70	RSW/PED	0.47	0.12	0.38	0.13
85	-0.18	RSW/PED	0.45	0.12	0.33	0.13
86	-2.10	RSW/PED	0.41	0.11	0.33	0.13
87	-4.70	RSW/PED	0.35	0.11	0.31	0.13
88	-8.20	RSW/PED	0.31	0.11	0.33	0.12
17	16.48	RPV	1.16	0.17	0.55	0.13
18	15.68	RPV	1.04	0.17	0.55	0.13
25	9.65	RPV	0.57	0.13	0.51	0.13
27	6.75	RPV	0.61	0.13	0.47	0.13
28	26.06	RPV	1.72	0.17	0.44	0.13
33	20.49	RPV	1.19	0.15	0.64	0.13
36	17.18	RPV	0.98	0.14	0.62	0.13
38	15.68	RPV	0.89	0.14	0.61	0.13
46	9.29	RPV	0.56	0.13	0.51	0.13
50	5.95	RPV	0.67	0.13	0.46	0.13
51	5.49	RPV	0.64	0.13	0.48	0.13
52	4.82	RPV	0.65	0.13	0.54	0.13
60	1.65	RPV	1.10	0.13	0.54	0.13
66	1.65	RPV	1.15	0.13	0.48	0.13

**Notes:**

- (1) For Node numbers, refer to DCD Figures 3A-8 and 3A-10.
- (2) DCD acceleration values are taken from DCD Tables 3A-23a through 3A-23d.
- (3) Horizontal accelerations are the envelopes of X and Y direction responses.

Table 3A-31 Comparison of Control Building DCD and STP 3&amp;4 Seismic Forces

Element No.	DCD Max. Shear (t)	STP 3&4 Max. Shear (t)	DCD Max. Moment (MN-m)	STP 3&4 Max. Moment (MN-m)	DCD Max. Torsion (MN-m)	STP 3&4 Max. Torsion (MN-m)
7	4,000	670	254.98	39.59	117.68	18.40
6	8,200	1,484	686.49	117.09	225.56	40.74
5	11,000	2,301	1176.84	212.96	294.21	63.19
4	11,000	3,343	1667.17	351.69	294.21	91.79
3	11,000	4,913	2255.61	617.08	294.21	134.91
2	11,000	6,223	2942.10	981.23	294.21	170.88

Note: Please refer to DCD Figure 3A-27 for location of element numbers. The DCD values are taken from DCD Table 3A-20.

Table 3A-32 Comparison of Control Building DCD and STP 3&amp;4 Maximum Accelerations

Node	Elev. TMSL (m)	Location	DCD Max. Horizontal Acceleration (g)	STP 3&4 Max. Horizontal Acceleration (g)	DCD Max. Vertical Acceleration (g)	STP 3&4 Max. Vertical Acceleration (g)
108	22.20	C/B Stick	1.02	0.14	0.48	0.14
107	17.15	C/B Stick	0.72	0.14	0.44	0.14
106	12.30	C/B Stick	0.52	0.13	0.36	0.14
105	7.90	C/B Stick	0.34	0.13	0.33	0.13
104	3.50	C/B Stick	0.32	0.13	0.31	0.13
103	-2.15	C/B Stick	0.31	0.12	0.31	0.12
102	-8.20	C/B Stick	0.31	0.12	0.30	0.12
113	17.15	C/B Floor	-	-	0.62	0.23
112	12.30	C/B Floor	-	-	0.58	0.21
111	7.90	C/B Floor	-	-	0.55	0.19
110	3.50	C/B Floor	-	-	0.51	0.17
109	-2.15	C/B Floor	-	-	0.49	0.15

**Notes:**

- (1) For Node numbers, refer to DCD Figure 3A-27.
- (2) DCD acceleration values are taken from DCD Table 3A-24.
- (3) Horizontal accelerations are the envelopes of X and Y direction responses.

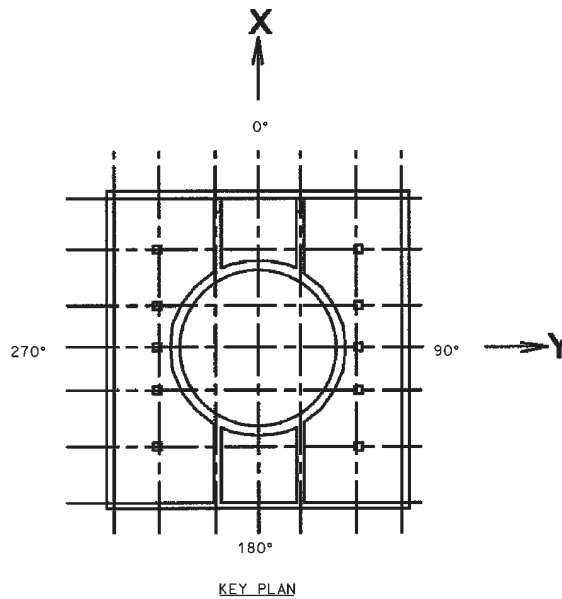
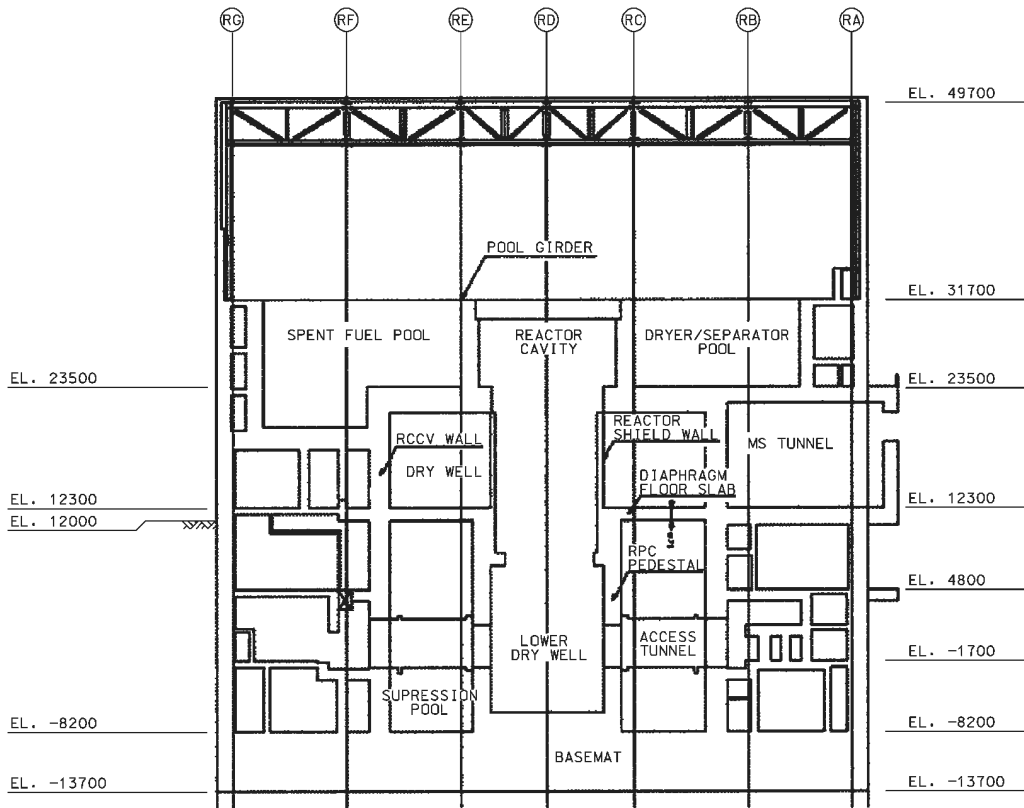

Figure 3A-229 Reactor Building Key Plan and Section



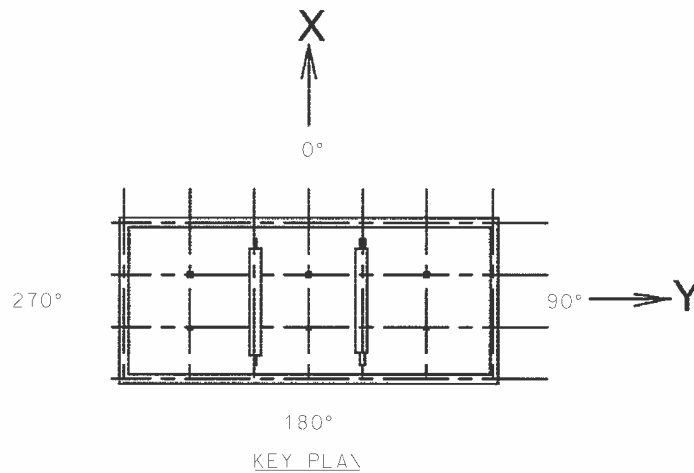
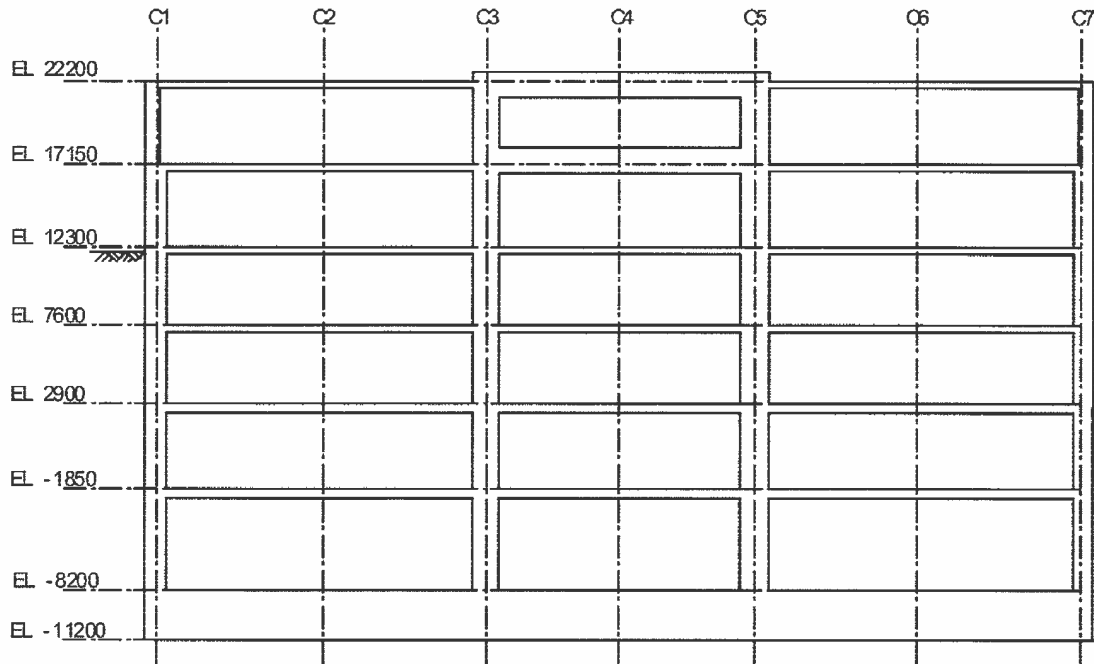

Figure 3A-230 Control Building Key Plan and Section

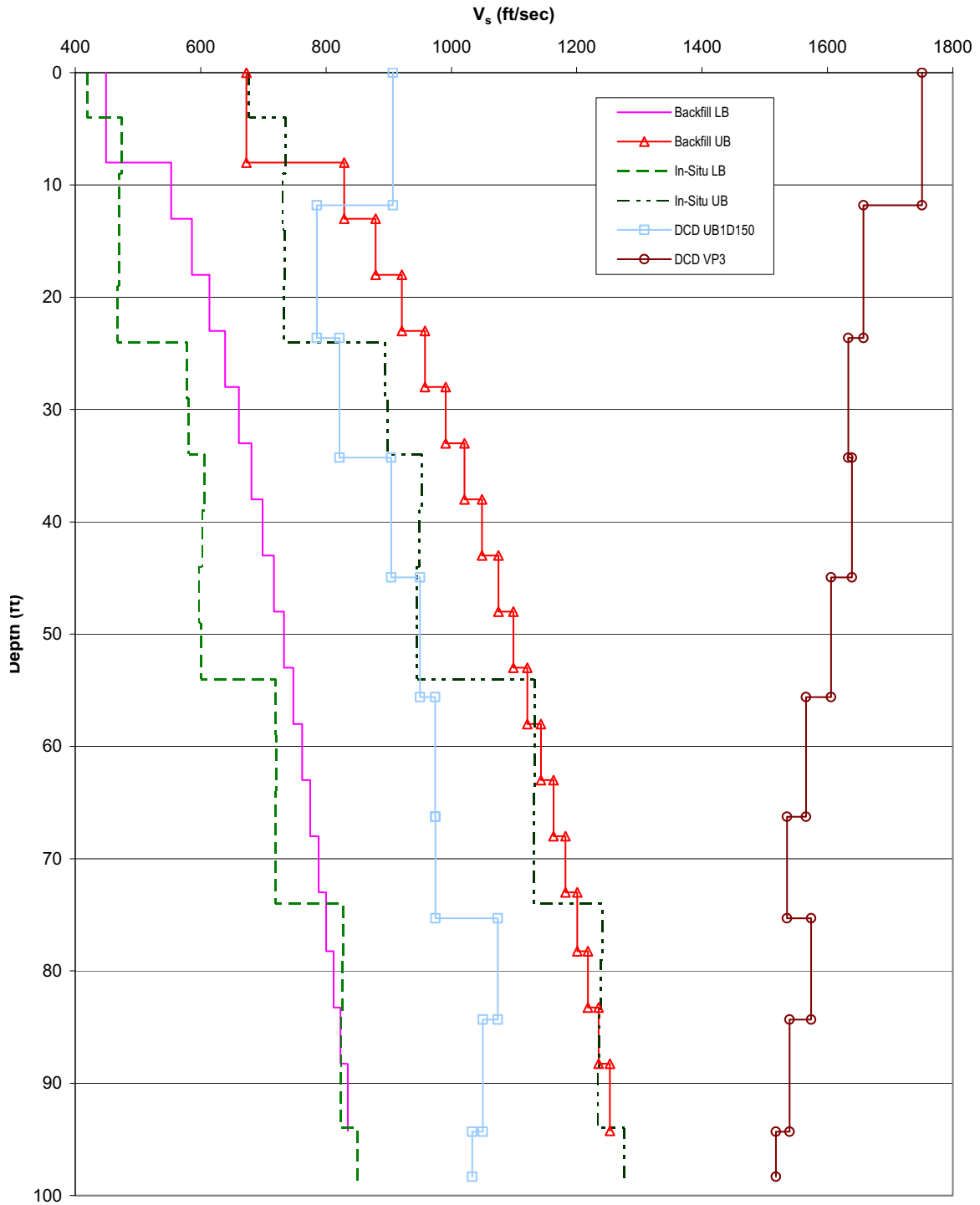

Figure 3A-230a Comparison of Strain-Compatible Shear Wave Velocity Profiles for Backfill

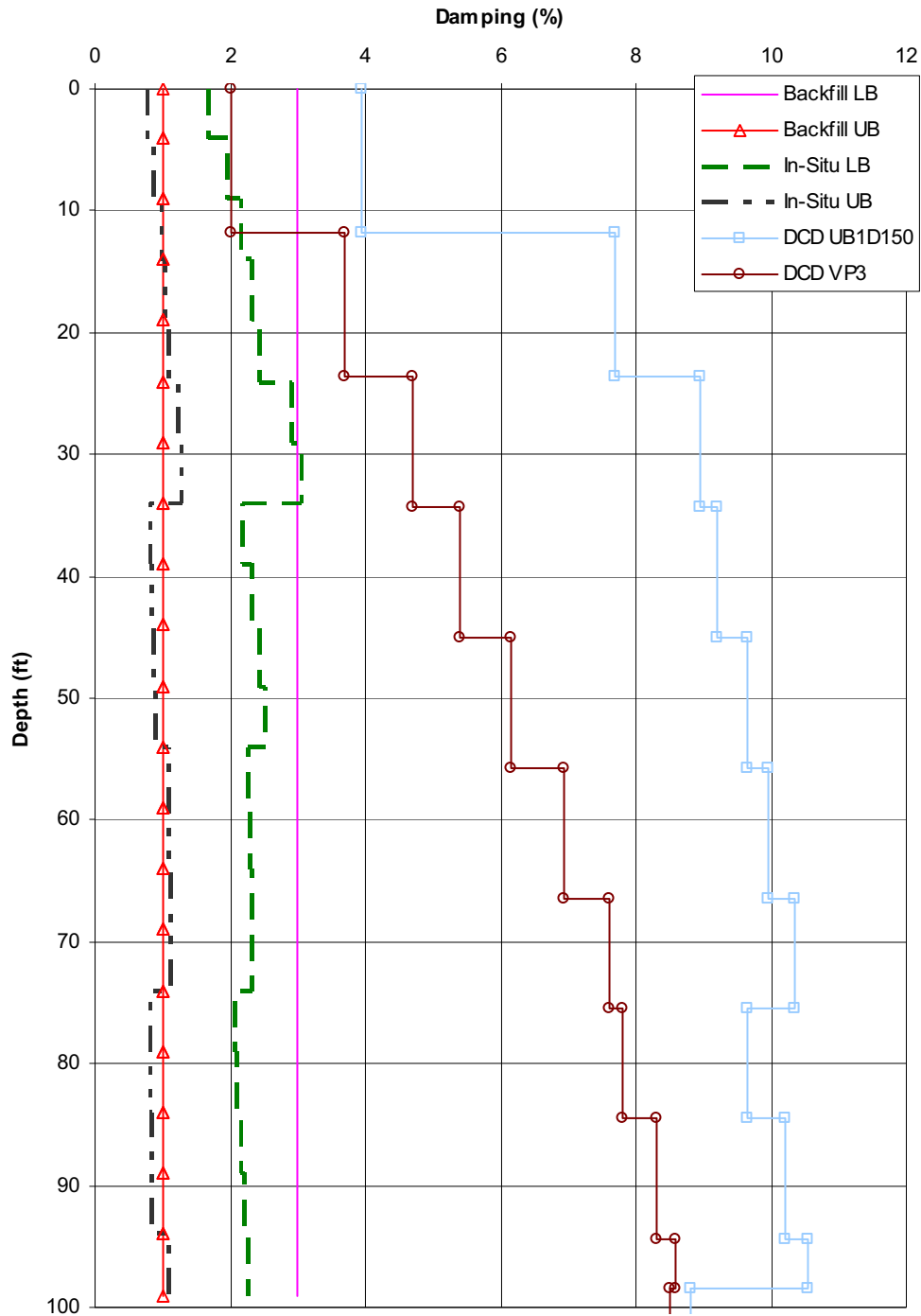

Figure 3A-230b Comparison of Strain-Compatible Damping Profile for Backfill

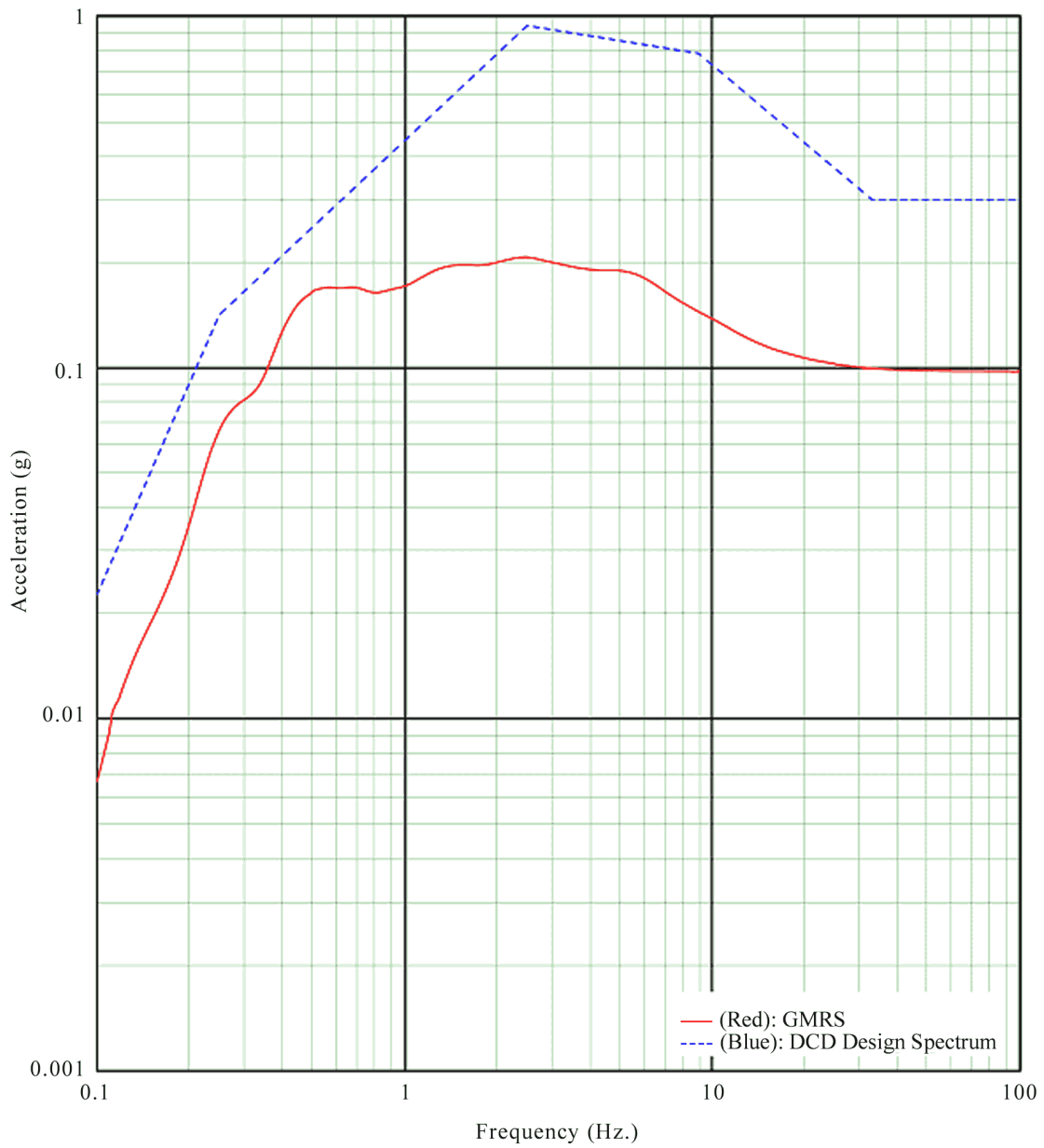

Figure 3A-231 Comparison of GMRS with DCD Design Spectrum (CSDRS) - Horizontal (5% damping)

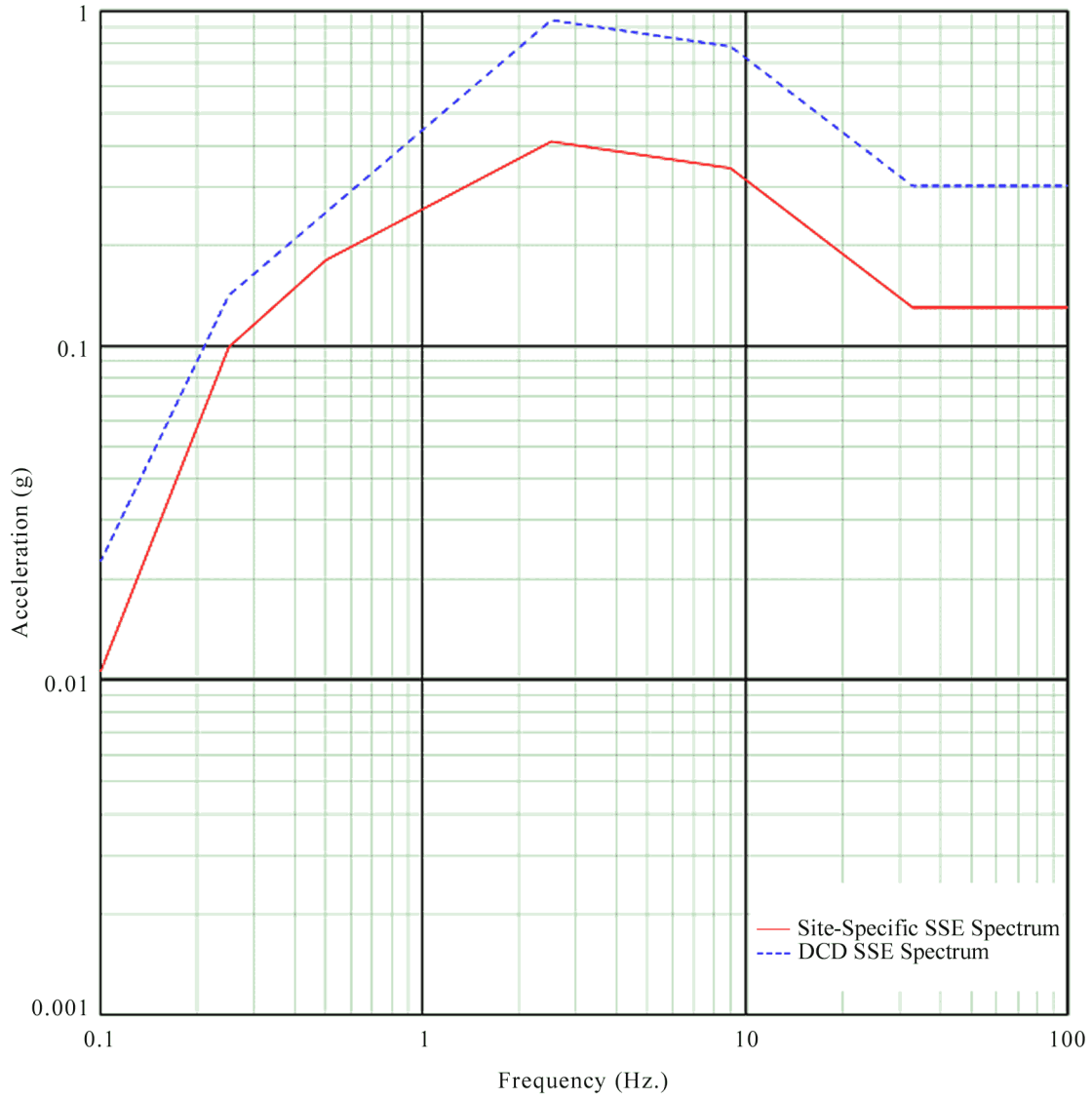

Figure 3A-231a Comparison of Site-Specific SSE Design Spectrum with DCD SSE Spectrum - Horizontal (5% damping)

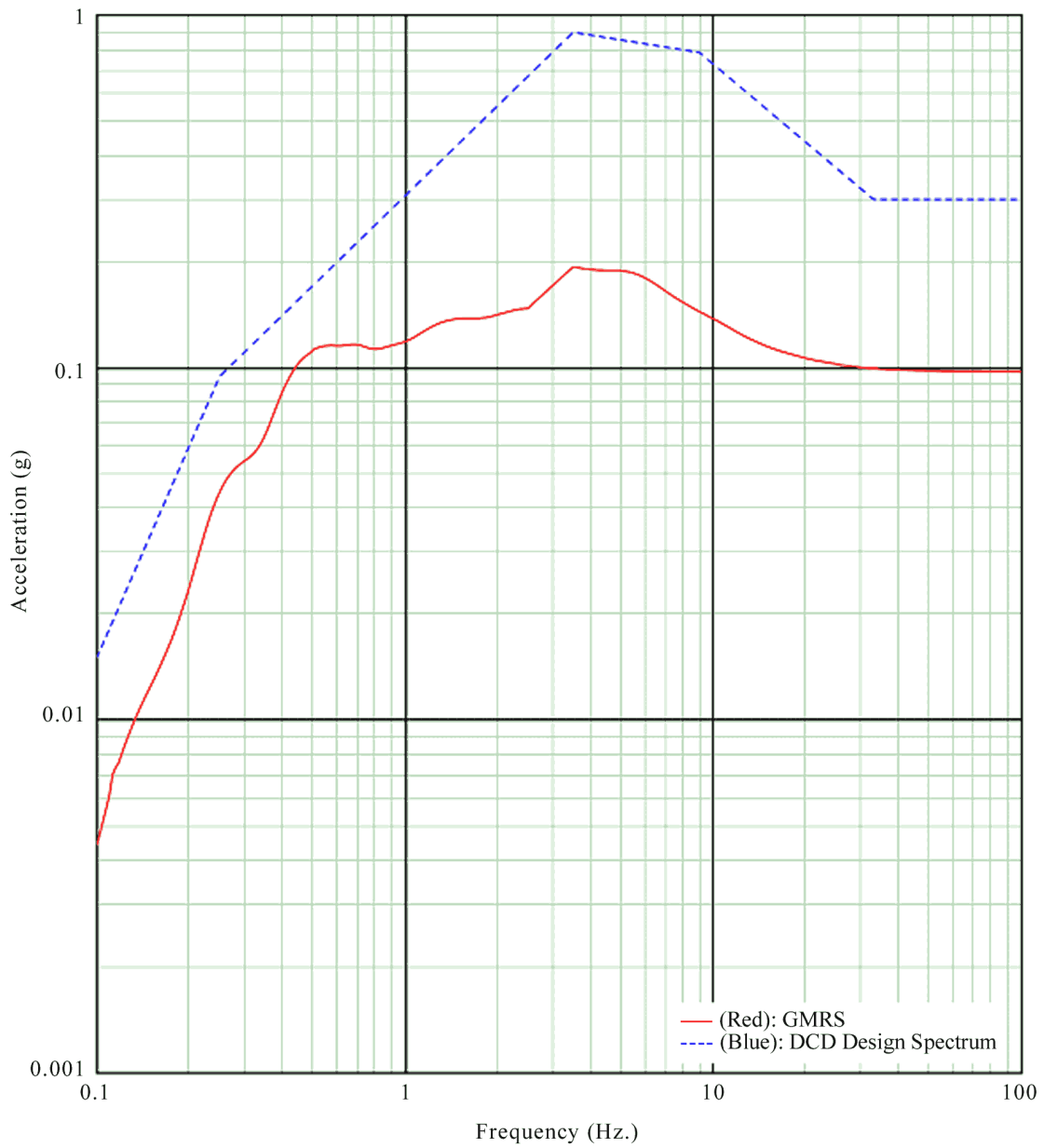

Figure 3A-232 Comparison of GMRS with DCD Design Spectrum (CSDRS) - Vertical (5% damping)

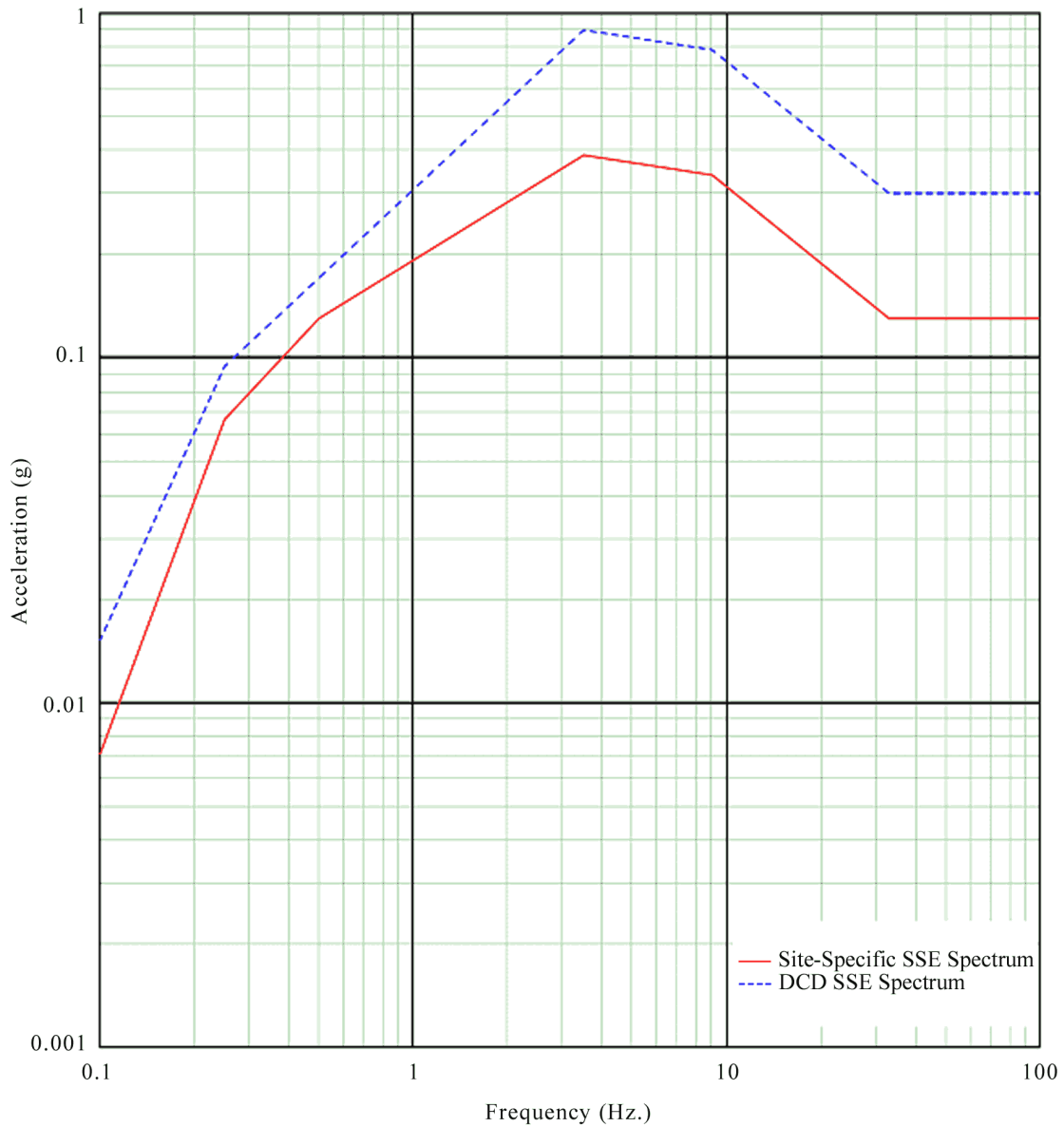

Figure 3A-232a Comparison of Site-Specific SSE Design Spectrum with DCD SSE Spectrum - Vertical (5% damping)

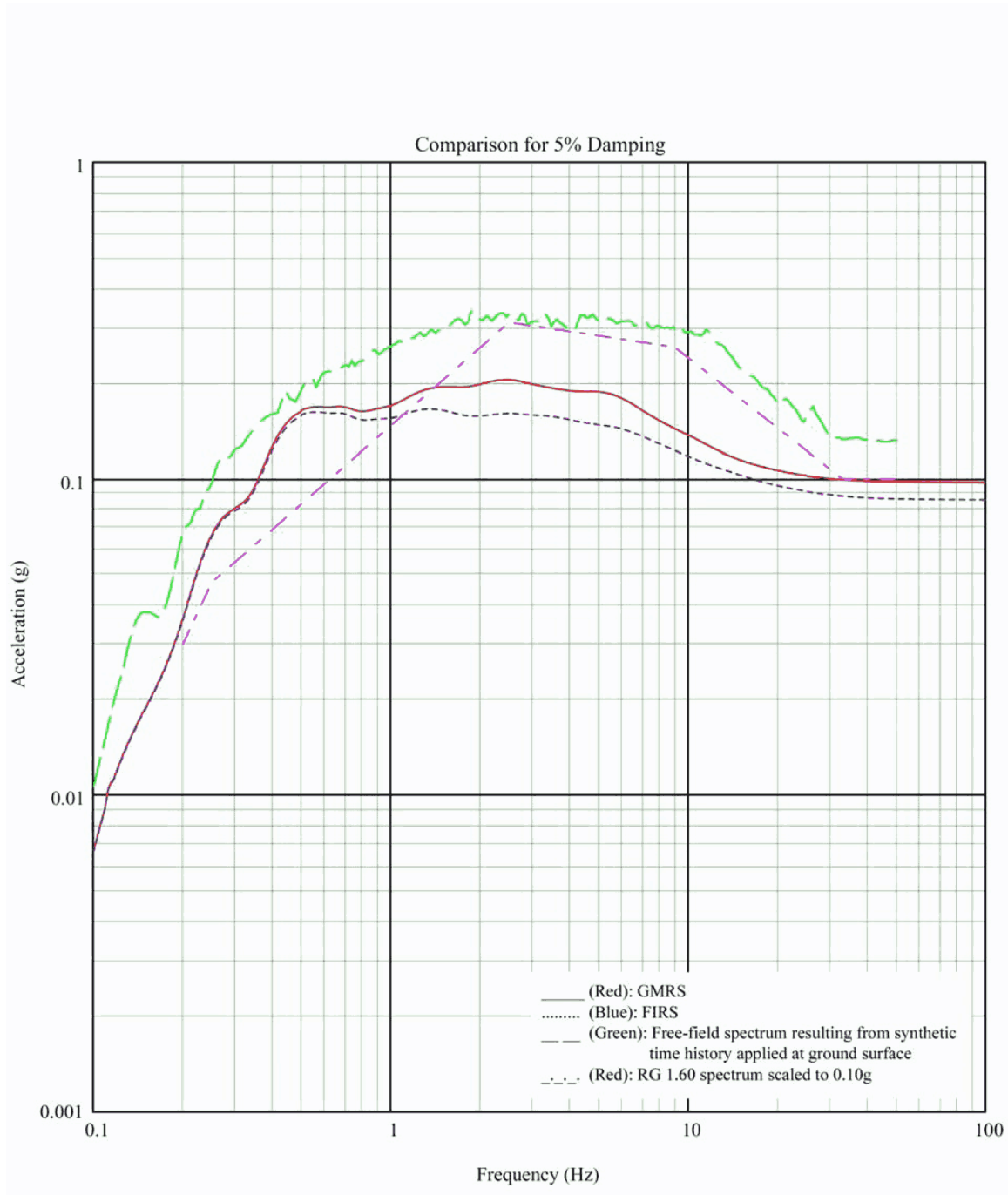

Figure 3A-233 Comparison of Spectra at Foundation of Reactor Building - Mean Soil Properties, X Direction



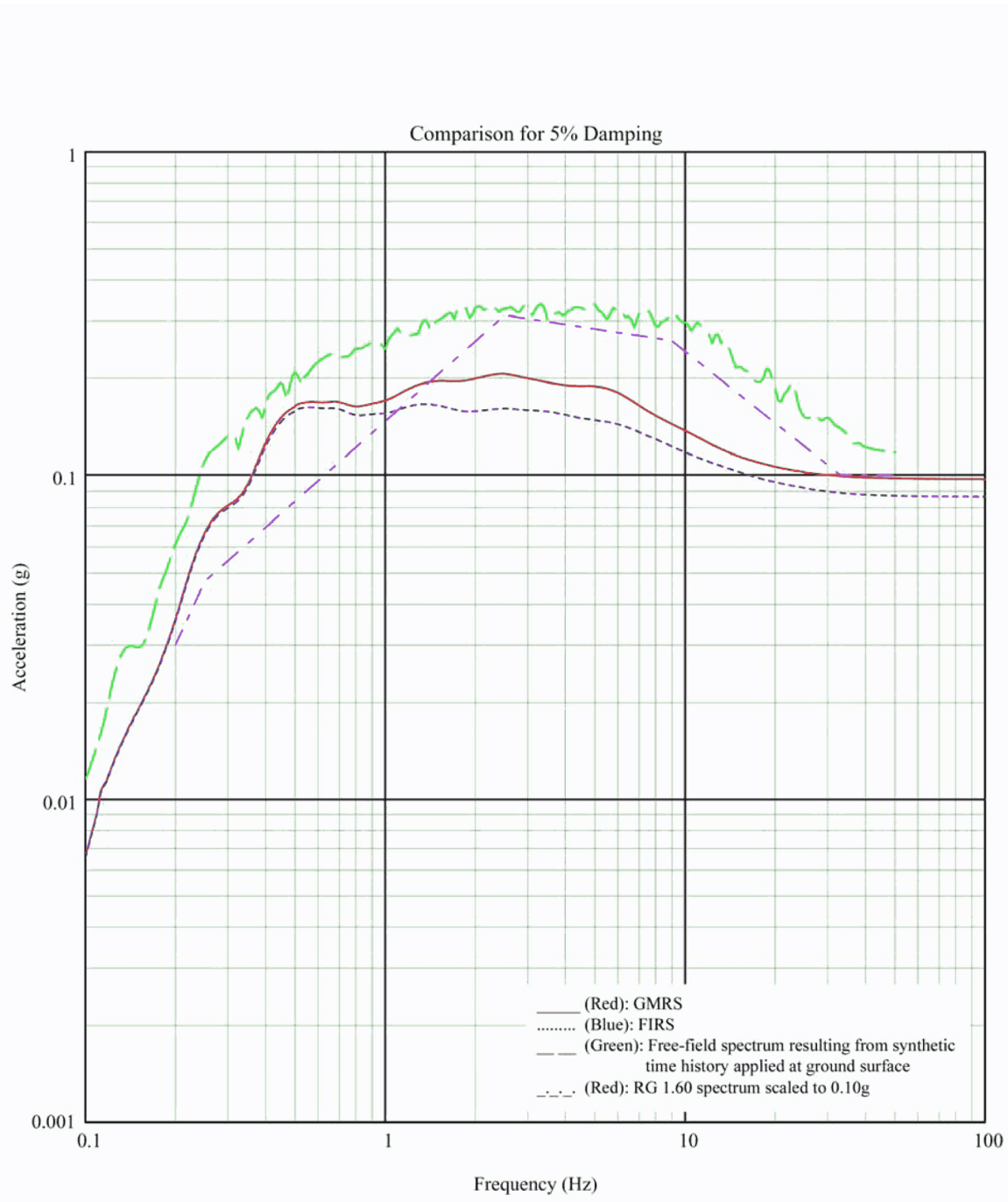

Figure 3A-234 Comparison of Spectra at Foundation of Reactor Building - Mean Soil Properties, Y Direction

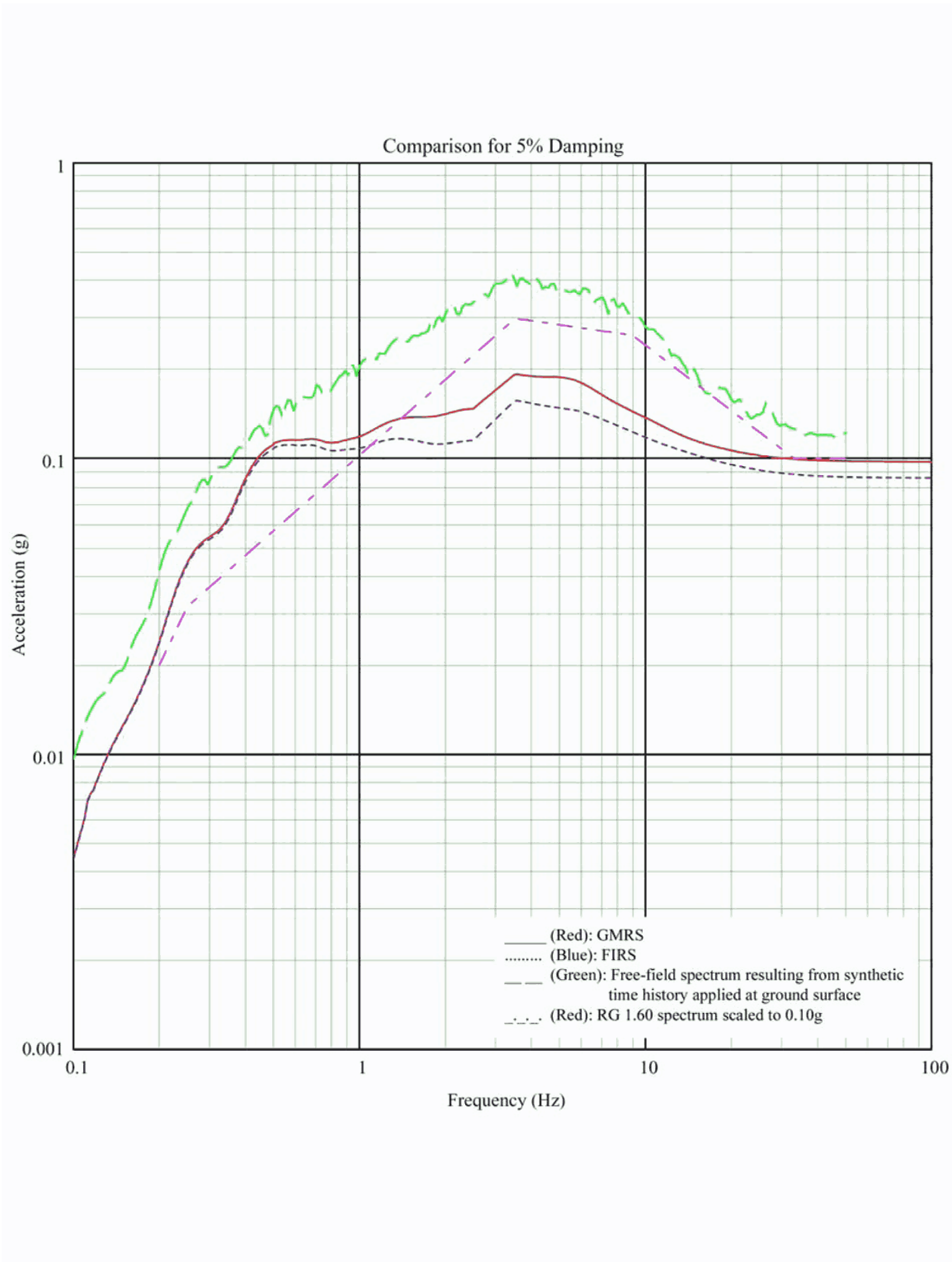

Figure 3A-235 Comparison of Spectra at Foundation of Reactor Building - Mean Soil Properties, Vertical Direction

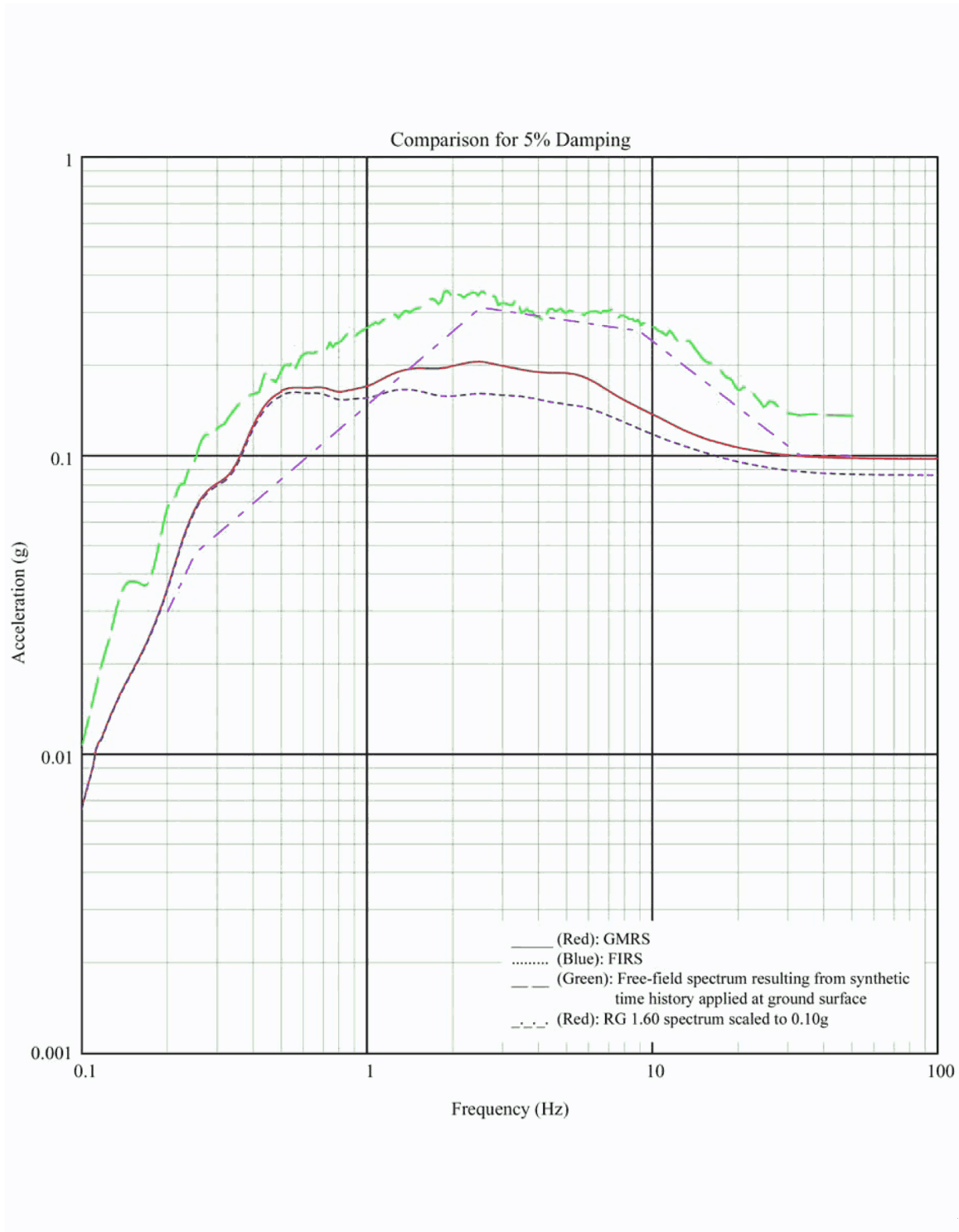

Figure 3A-236 Comparison of Spectra at Foundation of Reactor Building - Upper Bound Soil Properties, X Direction

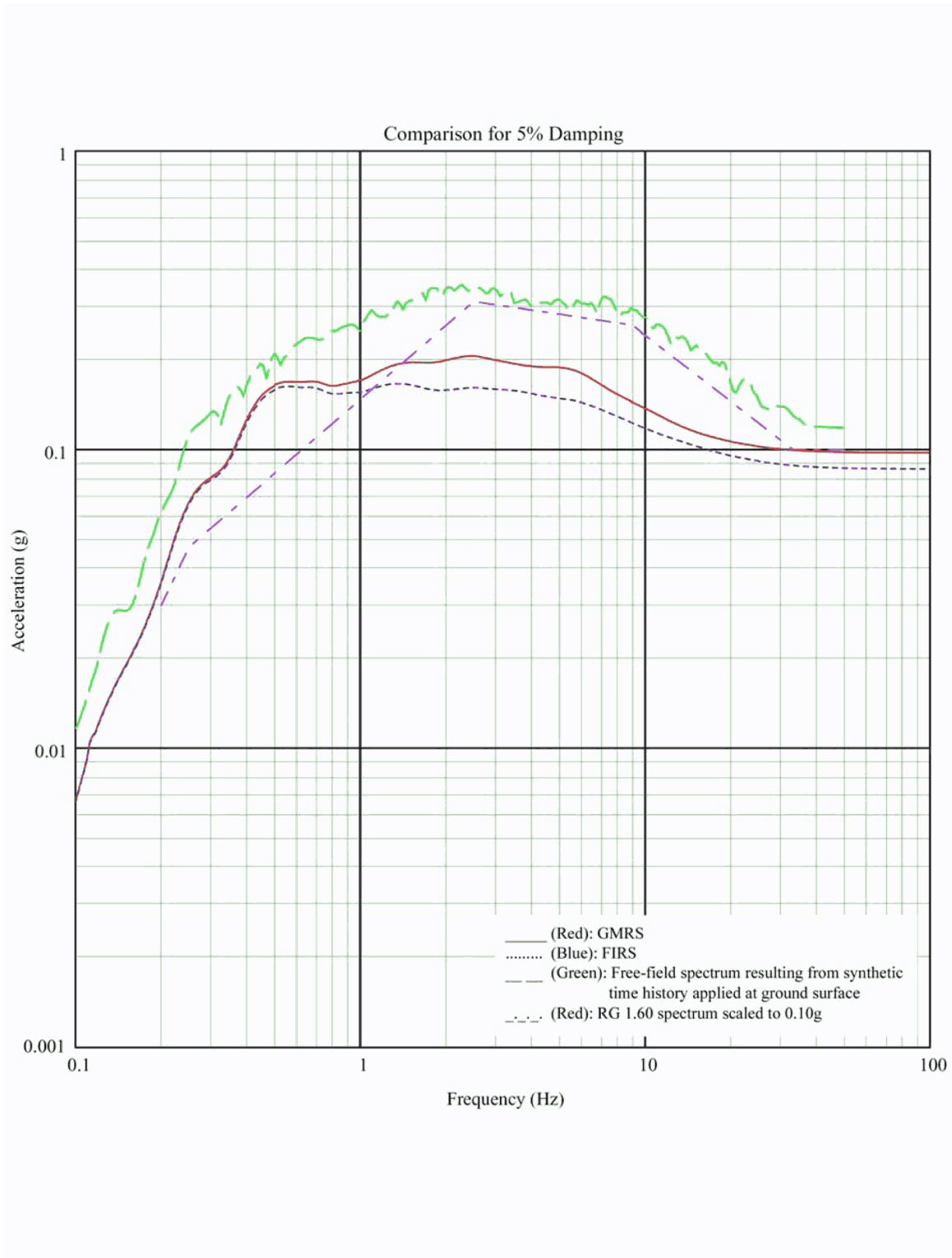

Figure 3A-237 Comparison of Spectra at Foundation of Reactor Building - Upper Bound Soil Properties, Y Direction

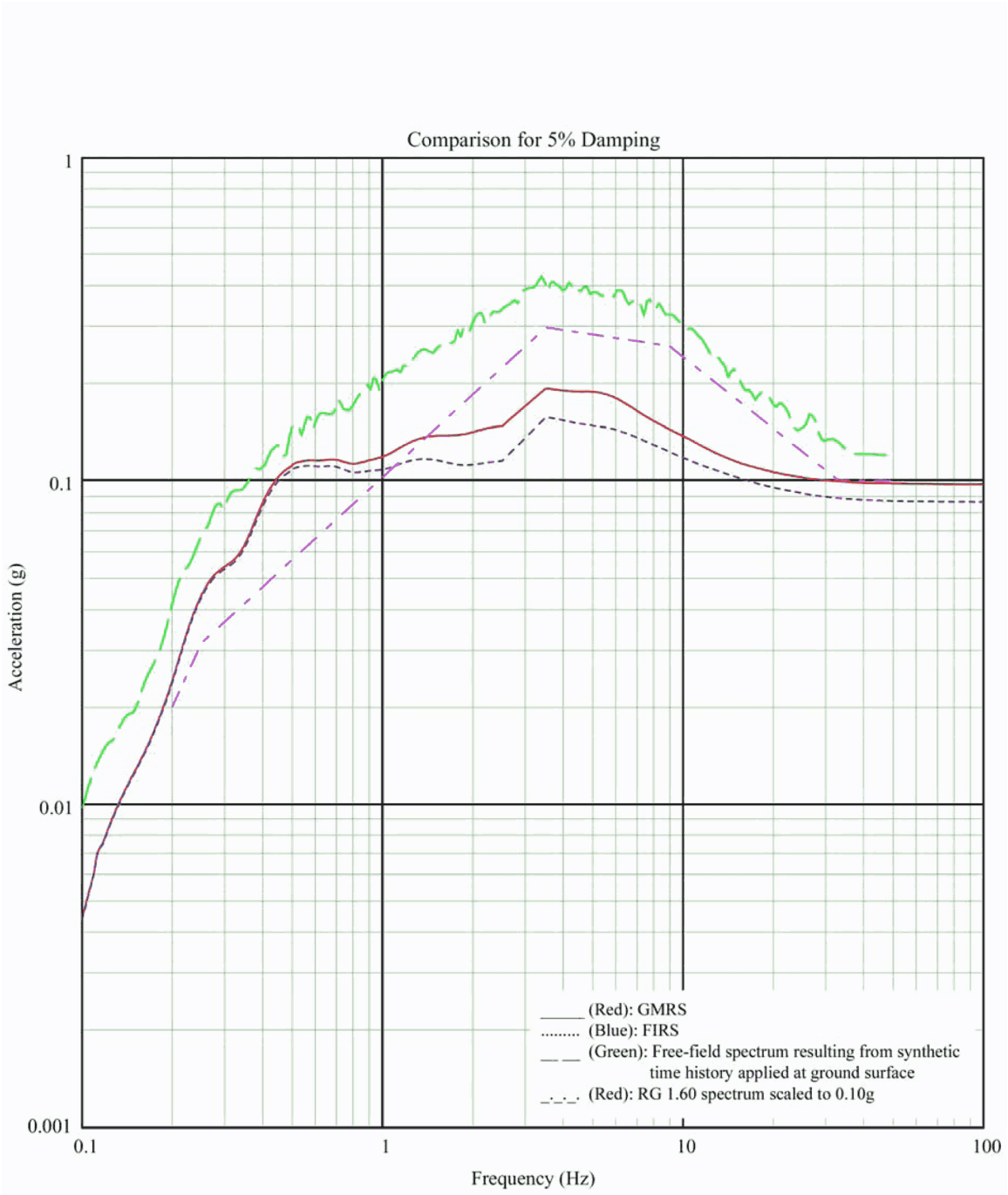

Figure 3A-238 Comparison of Spectra at Foundation of Reactor Building - Upper Bound Soil Properties, Vertical Direction

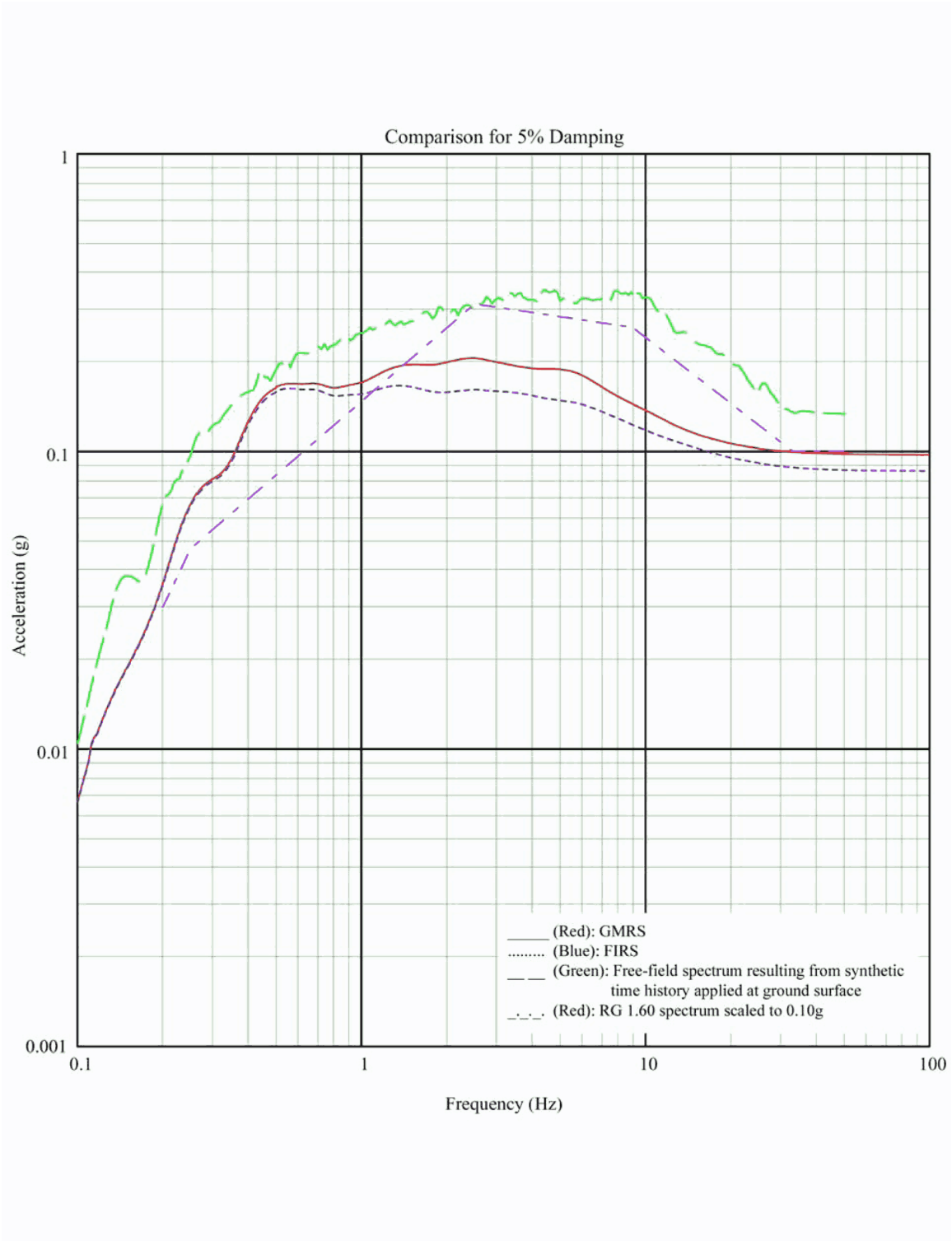

Figure 3A-239 Comparison of Spectra at Foundation of Reactor Building - Lower Bound Soil Properties, X Direction

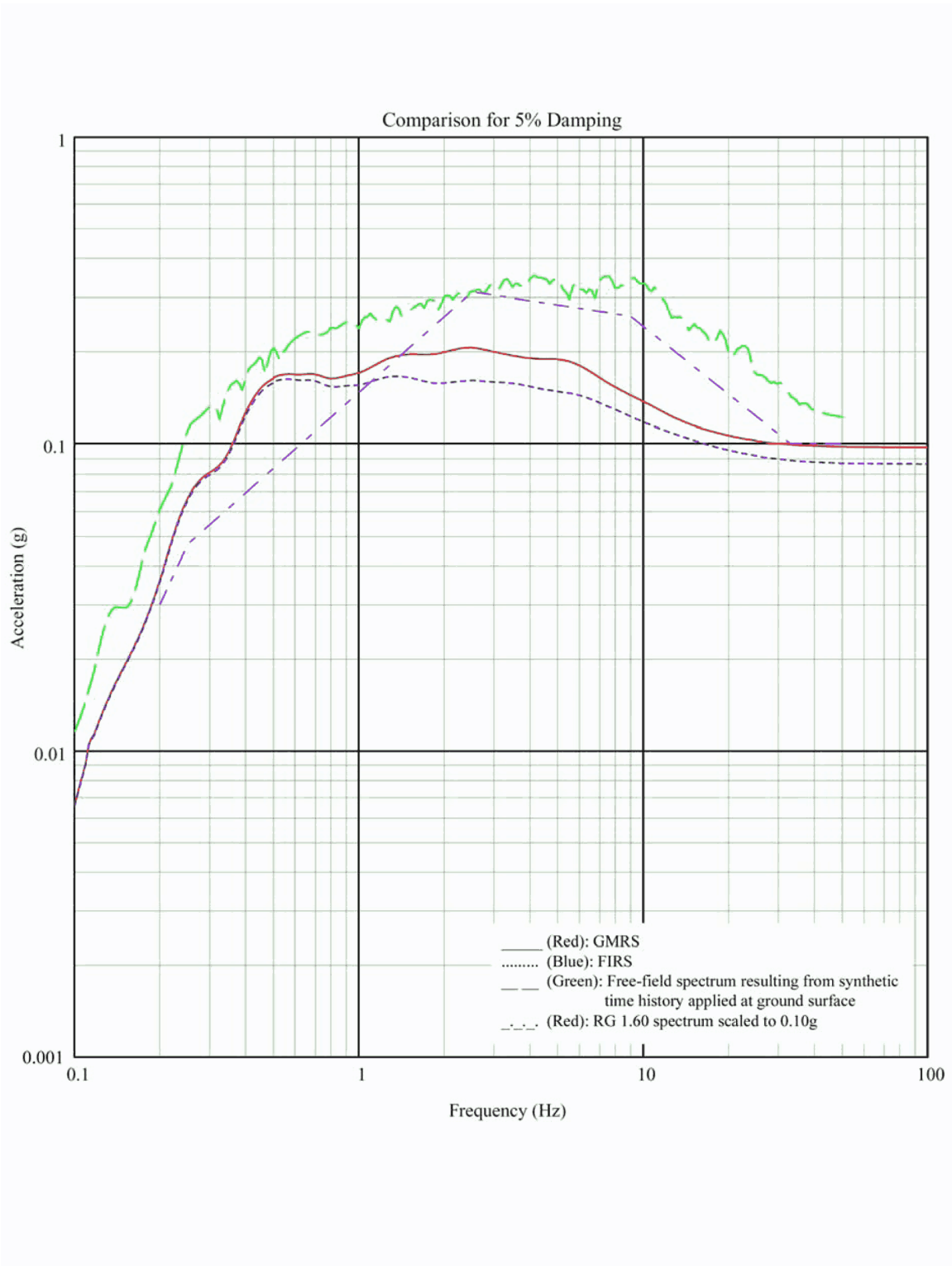

Figure 3A-240 Comparison of Spectra at Foundation of Reactor Building - Lower Bound Soil Properties, Y Direction

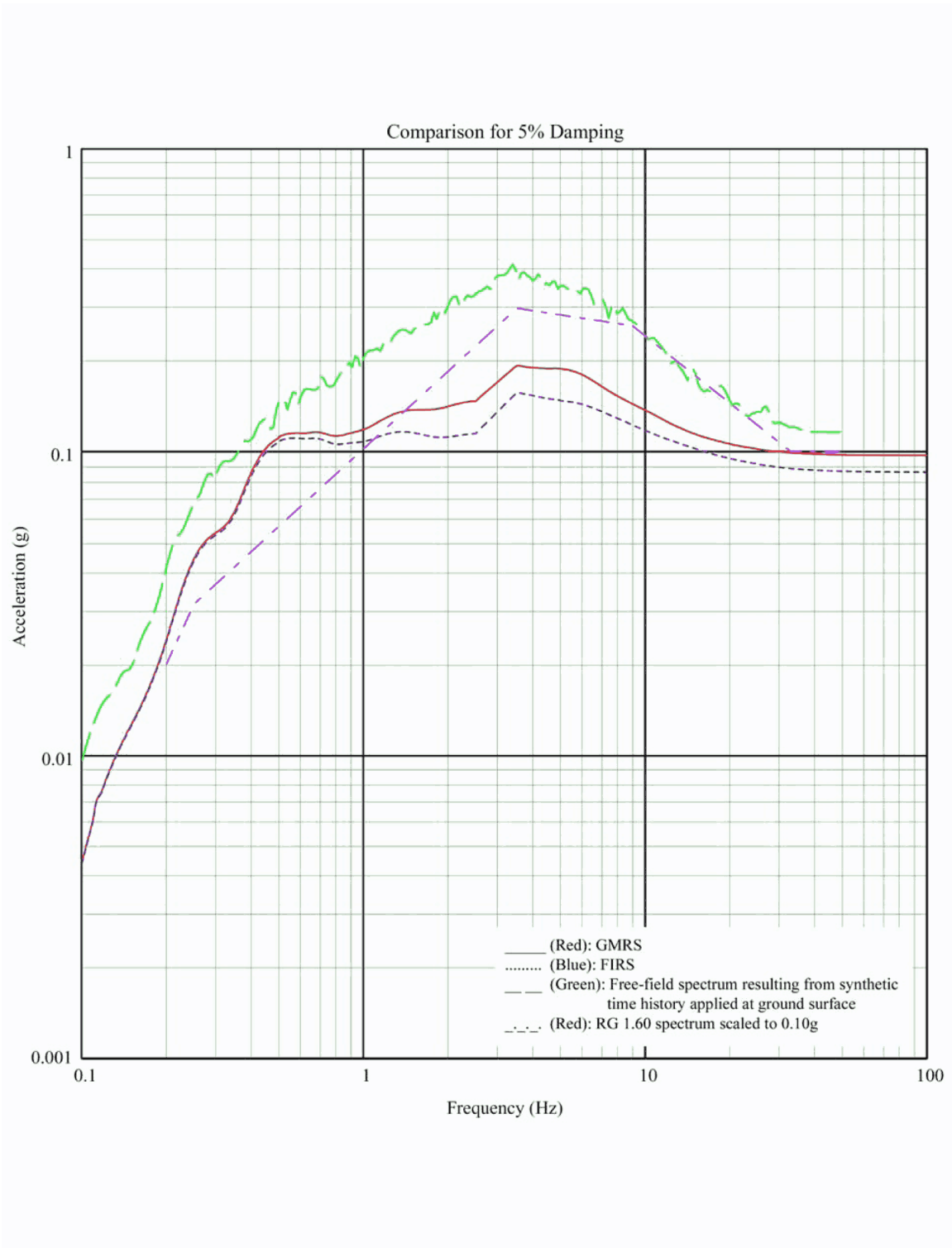

Figure 3A-241 Comparison of Spectra at Foundation of Reactor Building - Lower Bound Soil Properties, Vertical Direction



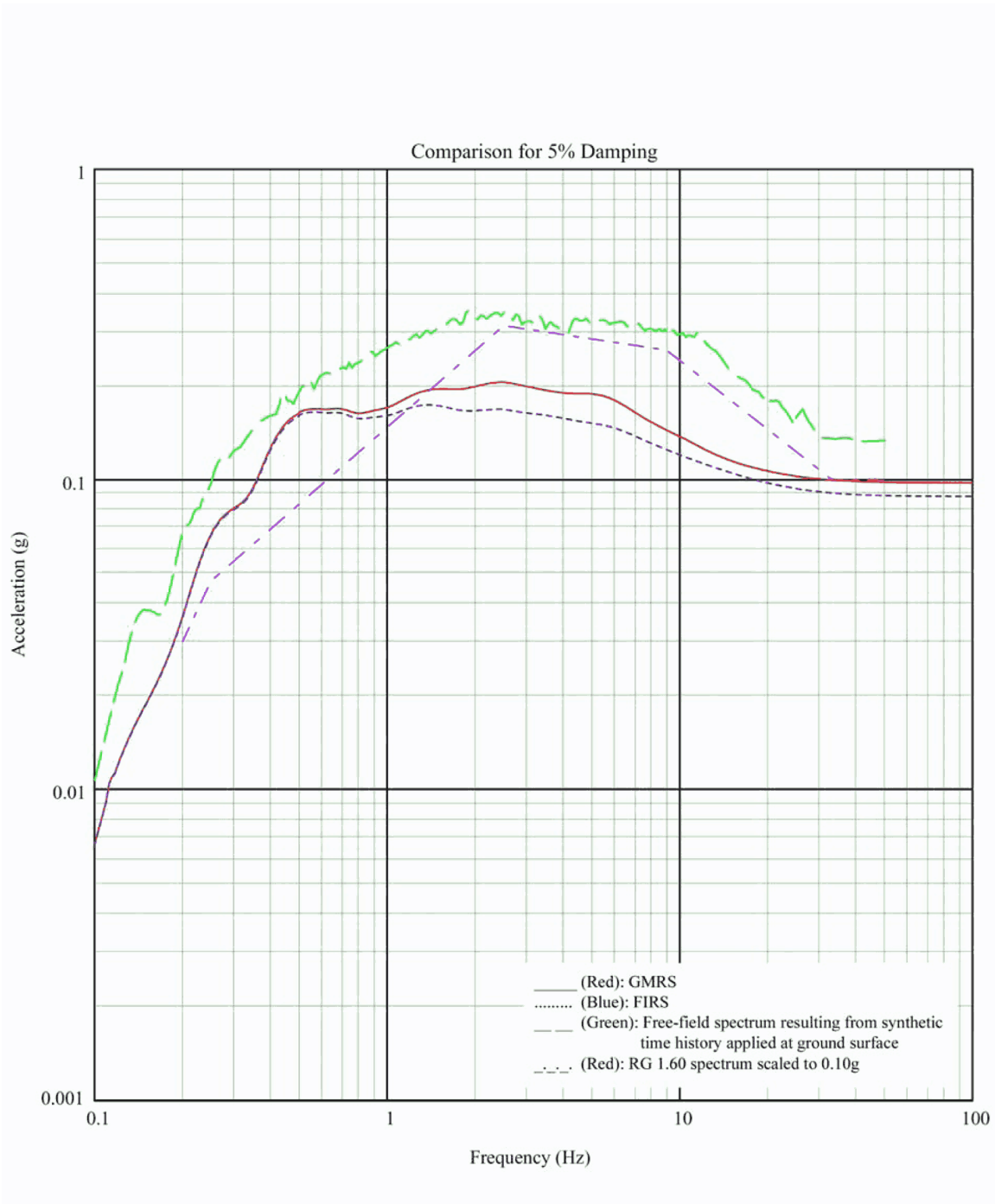

Figure 3A-242 Comparison of Spectra at Foundation of Control Building - Mean Soil Properties, X Direction

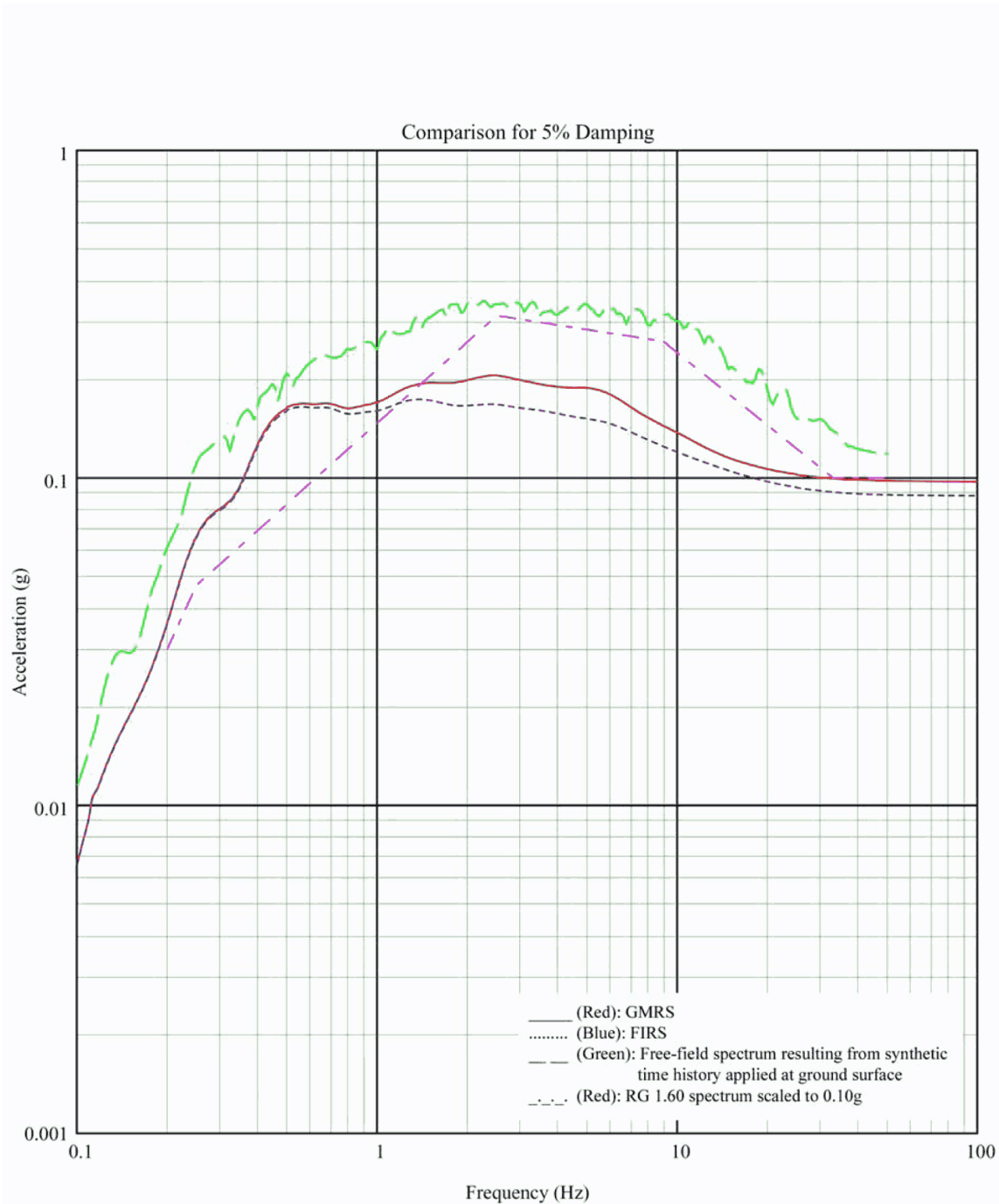

Figure 3A-243 Comparison of Spectra at Foundation of Control Building - Mean Soil Properties, Y Direction

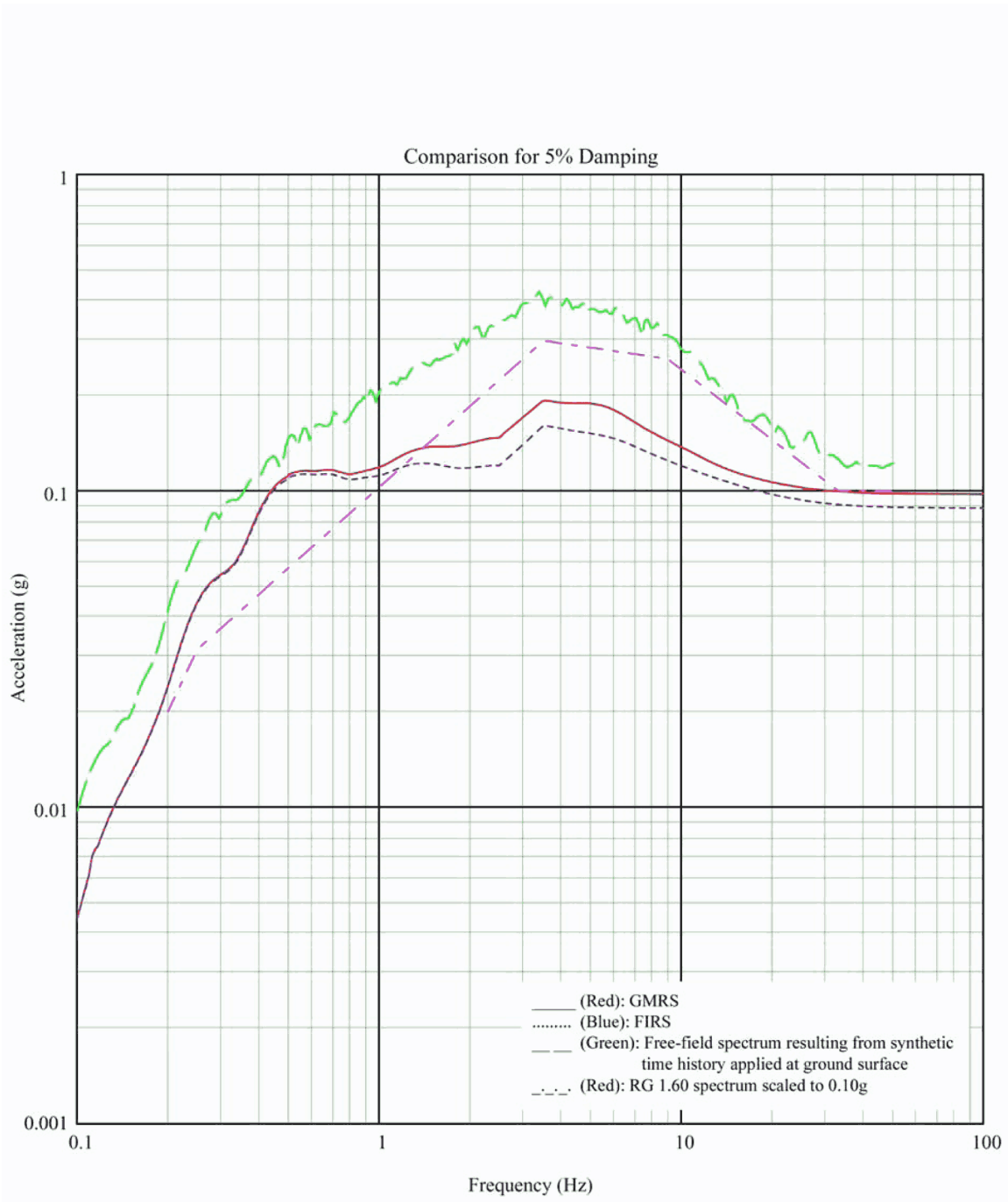

Figure 3A-244 Comparison of Spectra at Foundation of Control Building - Mean Soil Properties, Vertical Direction

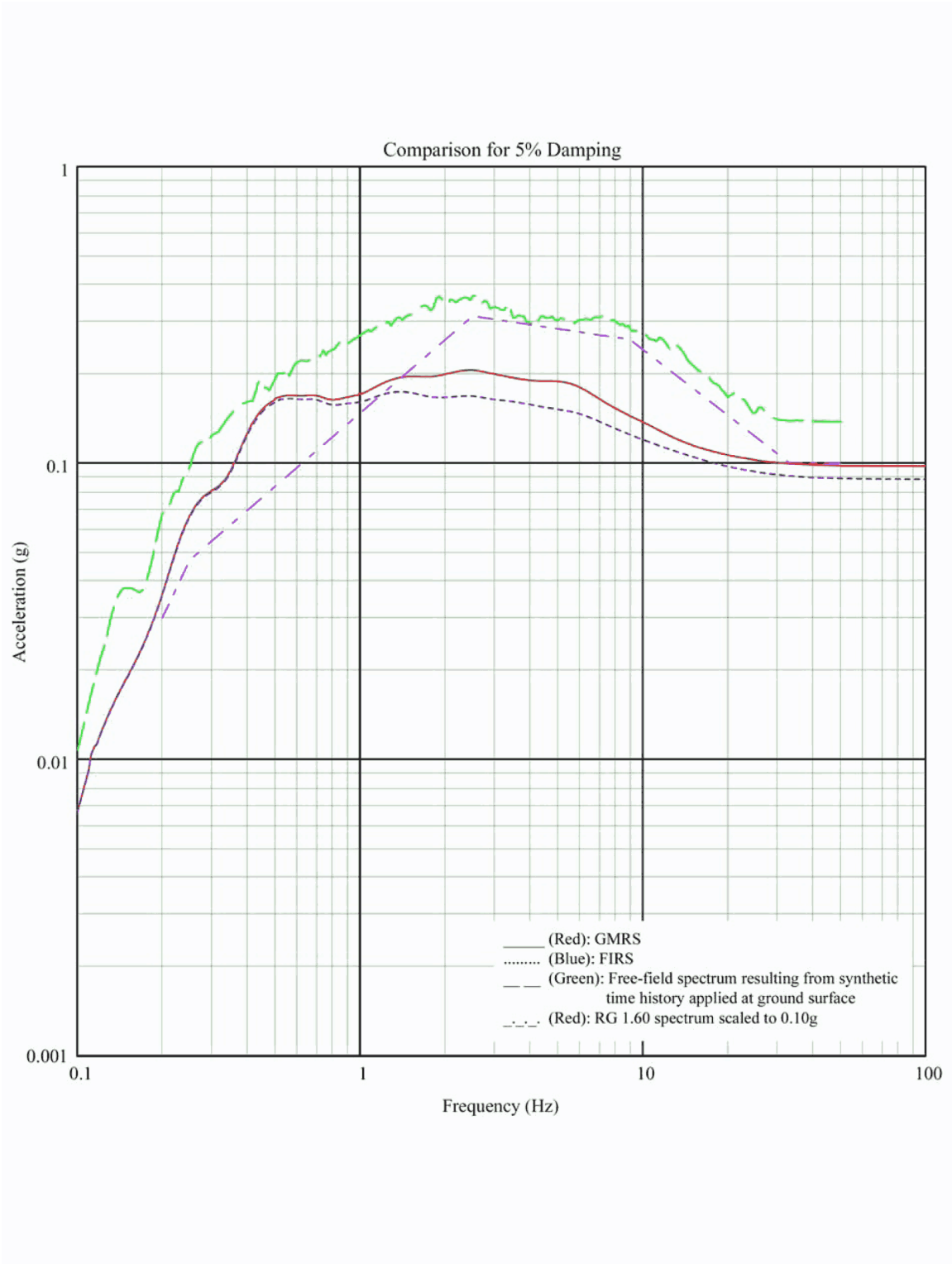

Figure 3A-245 Comparison of Spectra at Foundation of Control Building - Upper Bound Soil Properties, X Direction

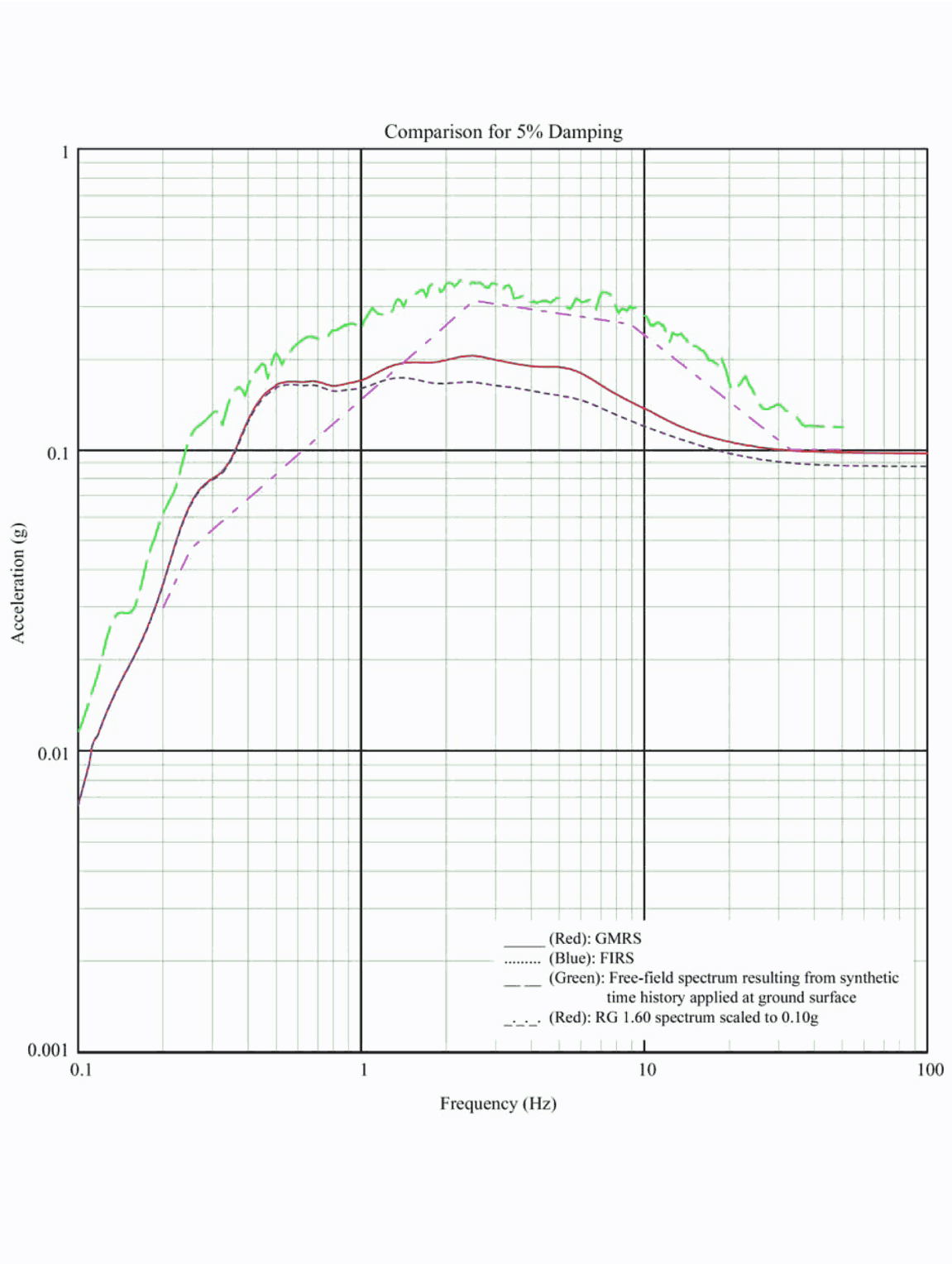

Figure 3A-246 Comparison of Spectra at Foundation of Control Building - Upper Bound Soil Properties, Y Direction

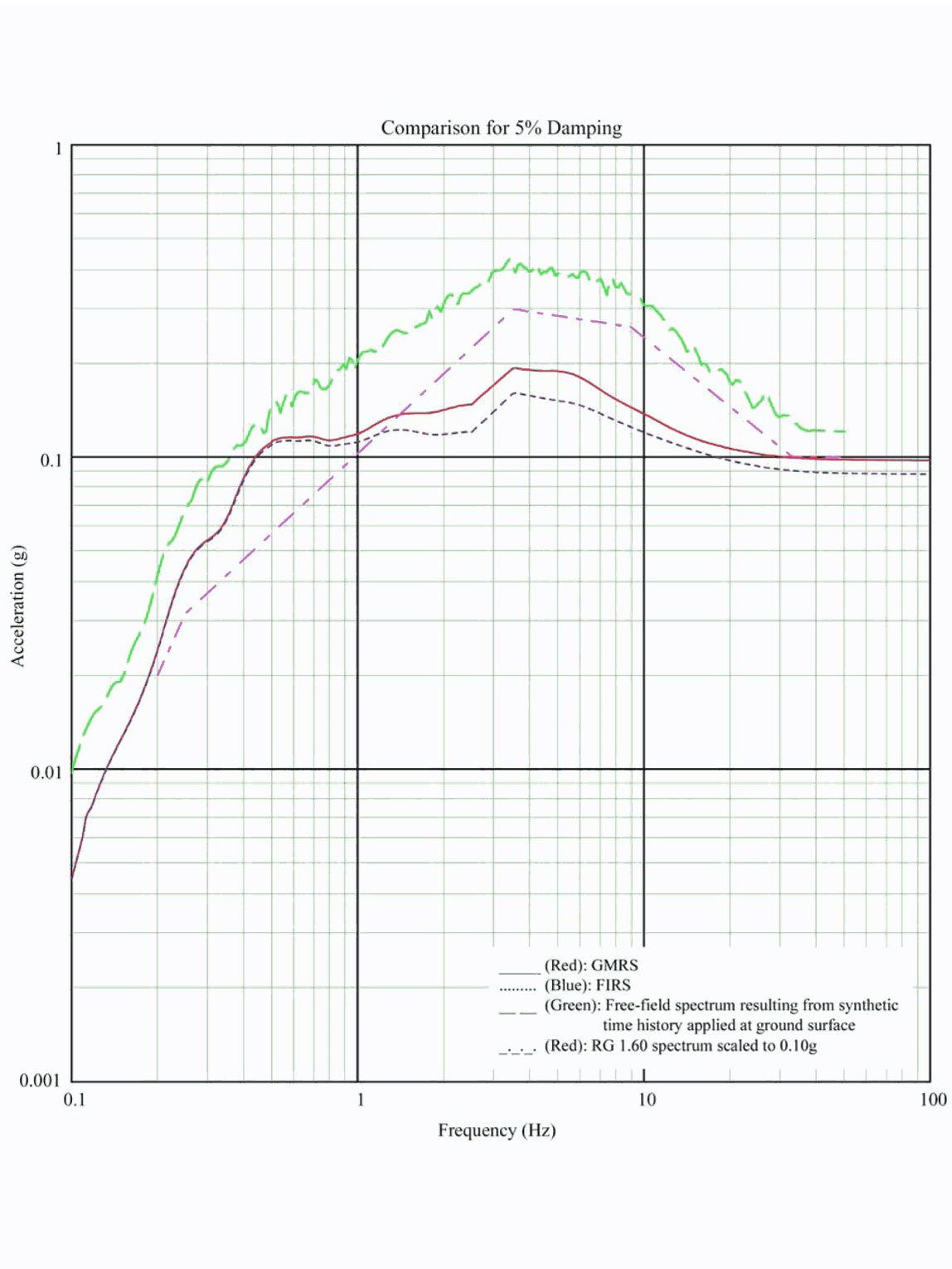

Figure 3A-247 Comparison of Spectra at Foundation of Control Building - Upper Bound Soil Properties, Vertical Direction

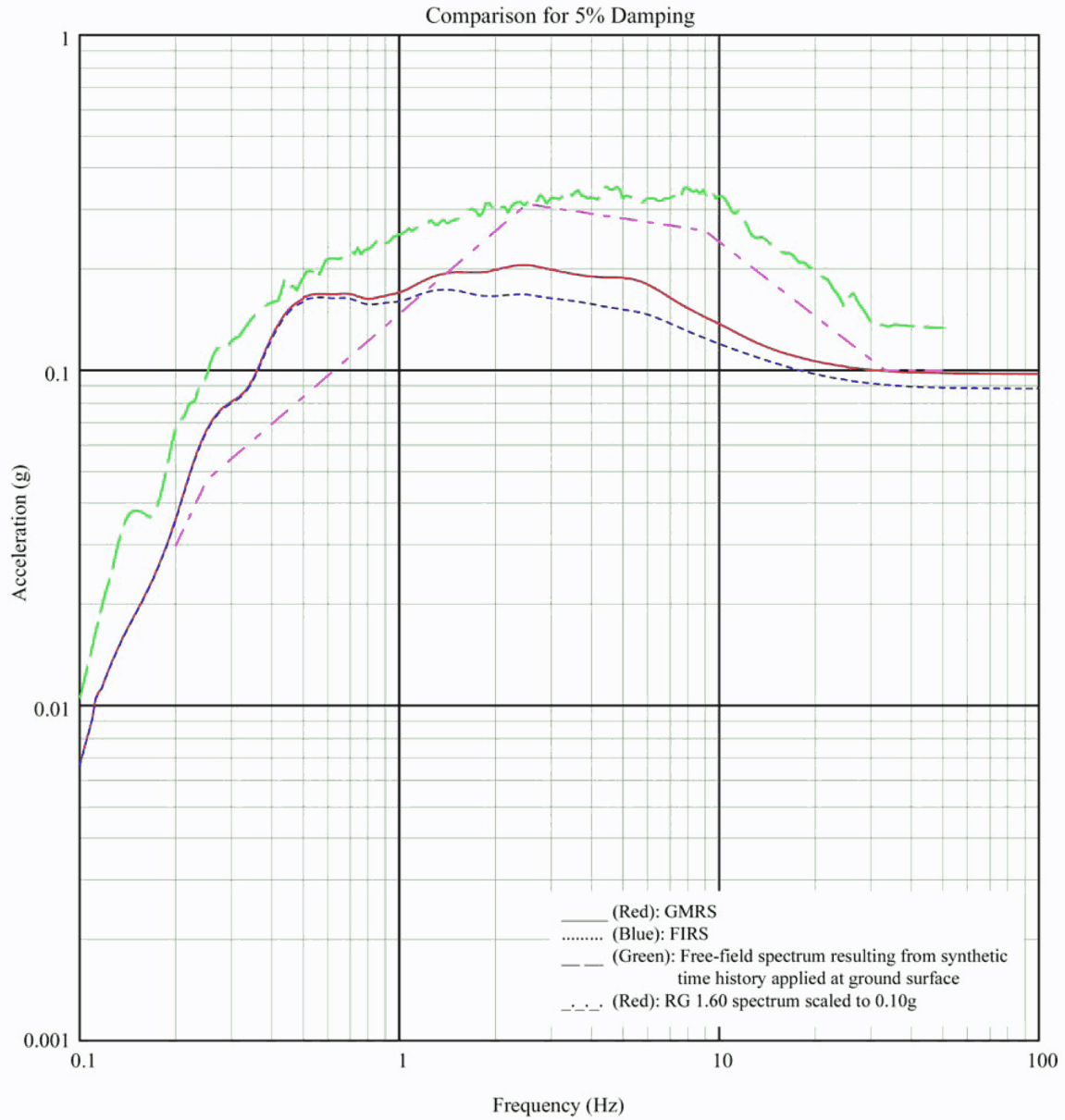

Figure 3A-248 Comparison of Spectra at Foundation of Control Building - Lower Bound Soil Properties, X Direction

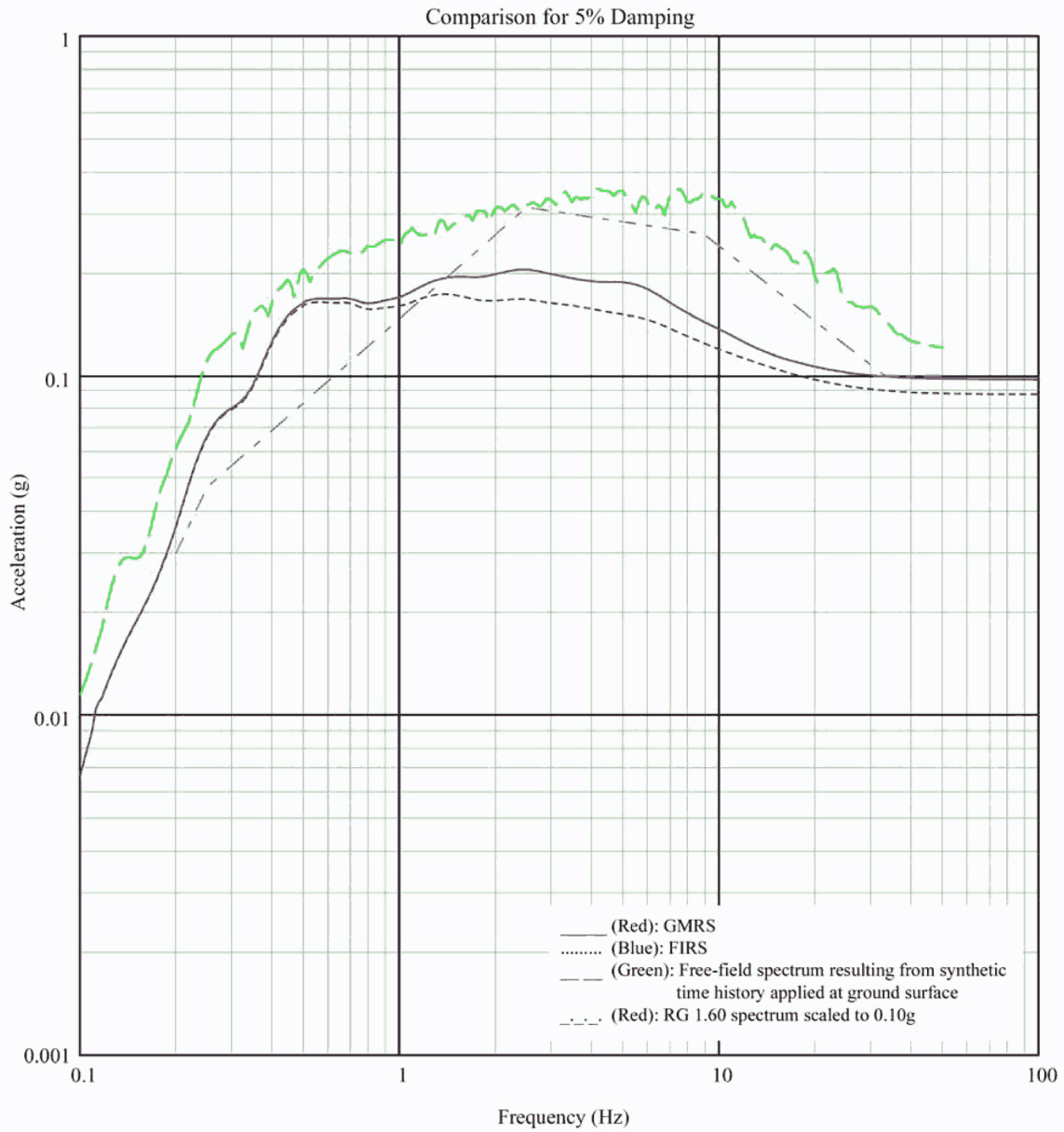

Figure 3A-249 Comparison of Spectra at Foundation of Control Building - Lower Bound Soil Properties, Y Direction



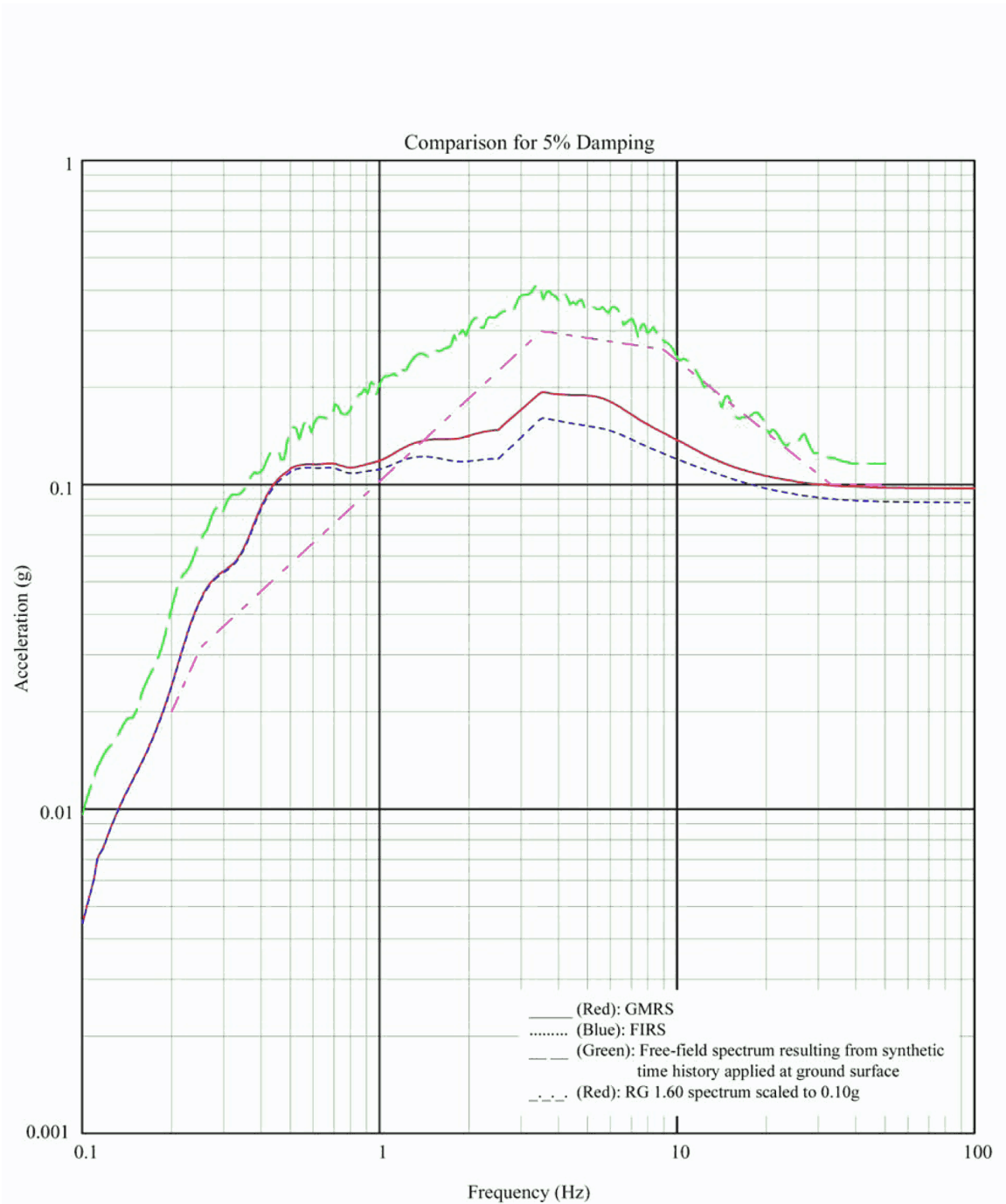

Figure 3A-250 Comparison of Spectra at Foundation of Control Building - Lower Bound Soil Properties, Vertical Direction

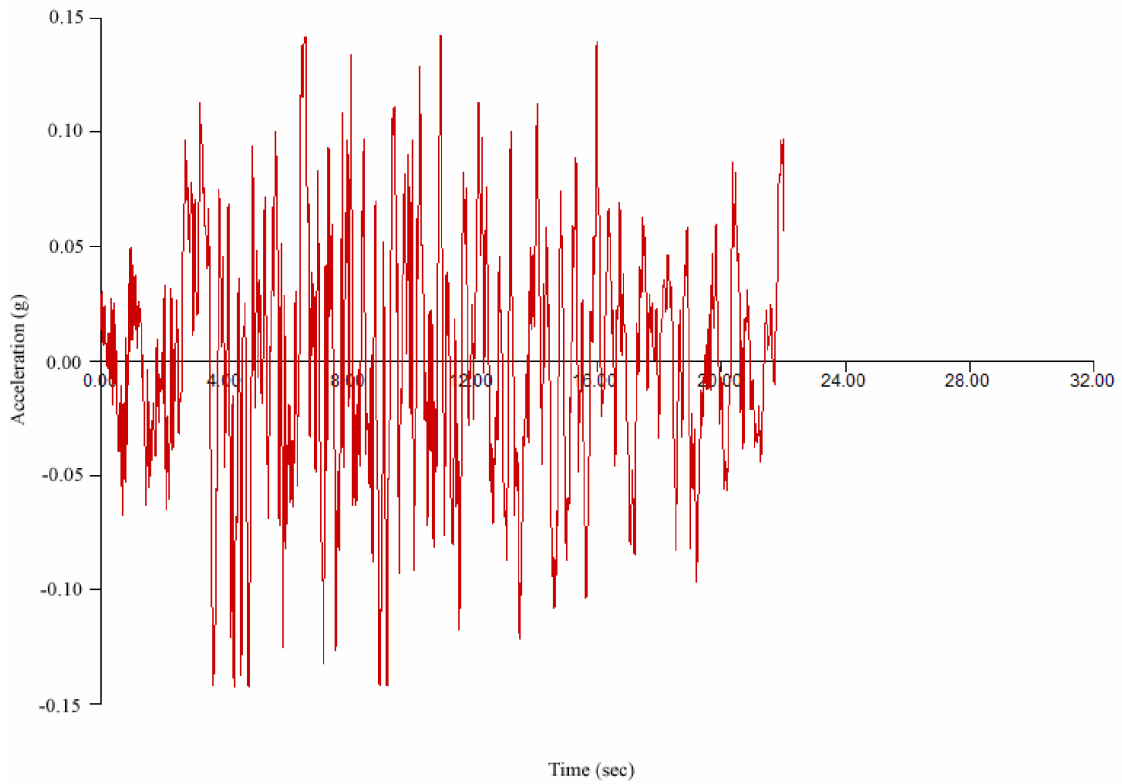

Figure 3A-251 Plot of Acceleration Time History (X Direction)

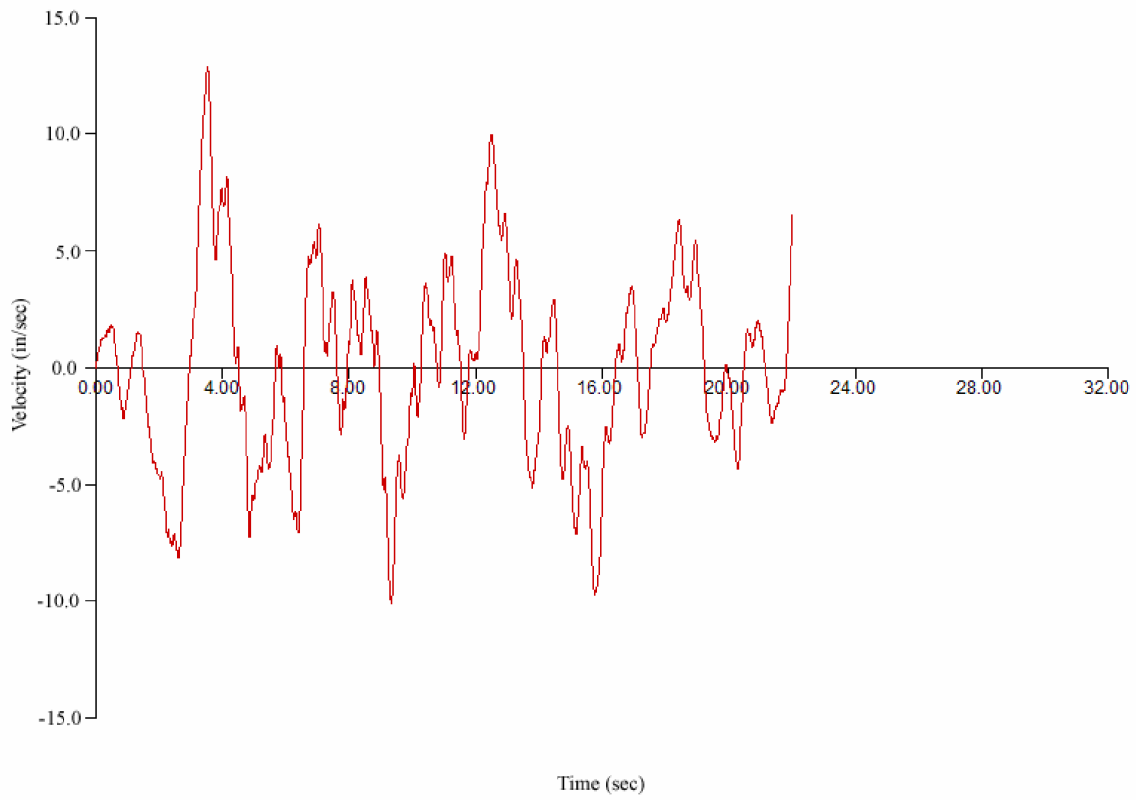

Figure 3A-252 Plot of Velocity Time History (X Direction)

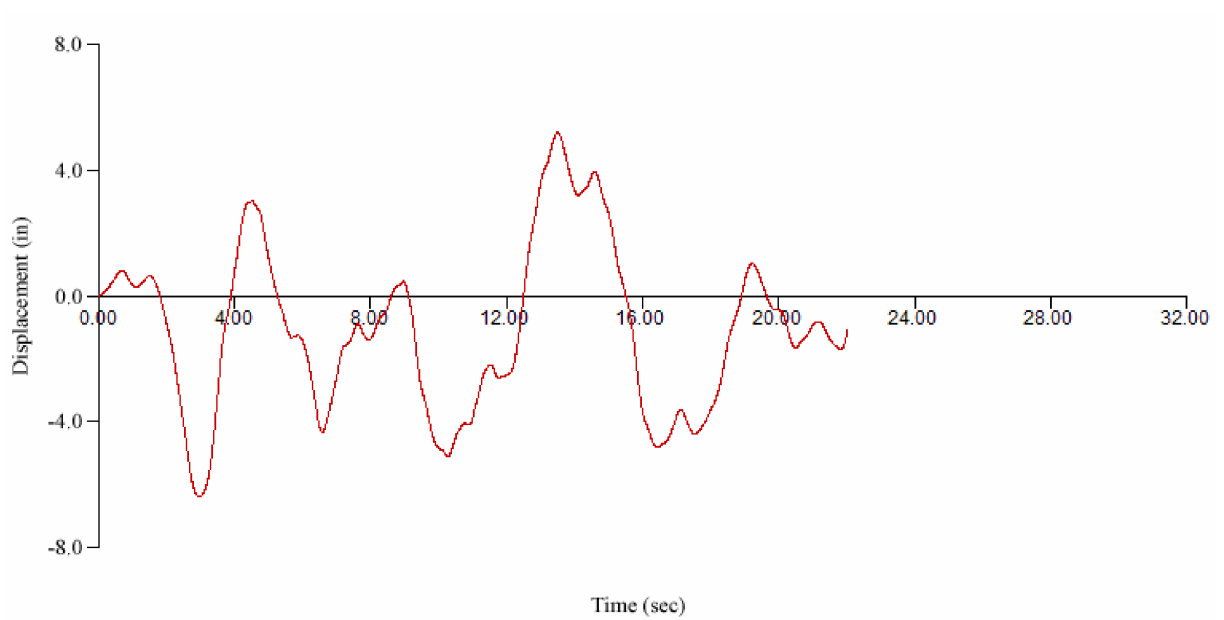

Figure 3A-253 Plot of Displacement Time History (X Direction)

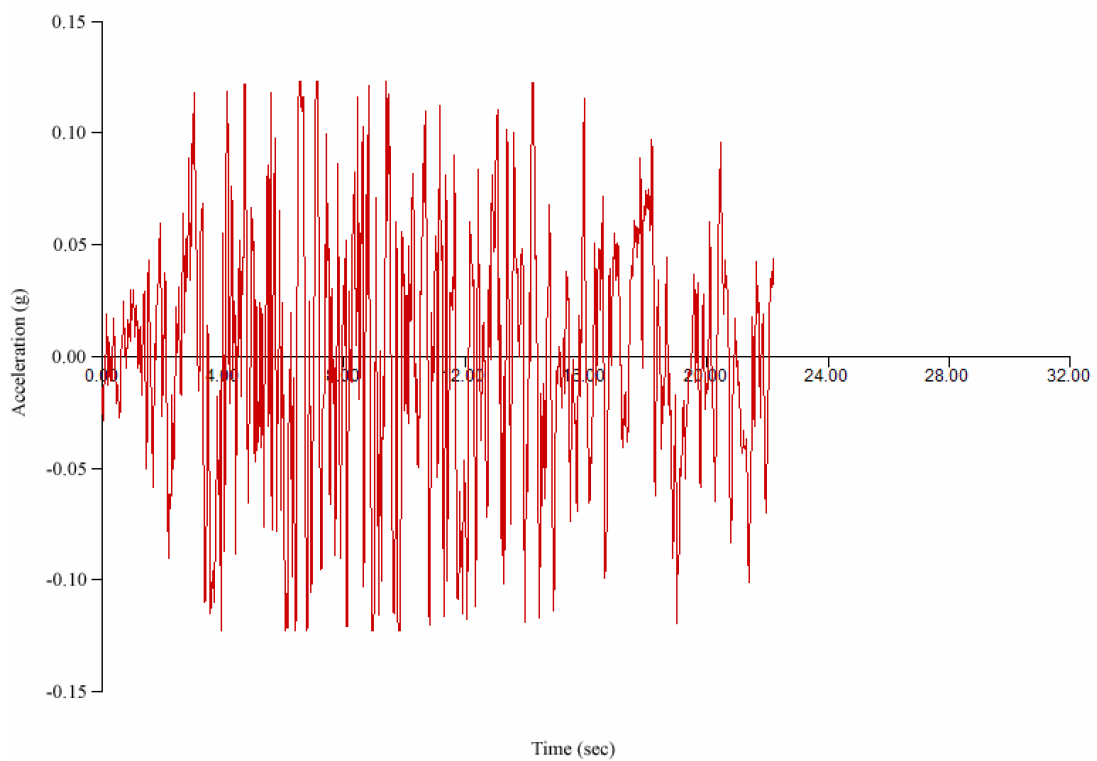

Figure 3A-254 Plot of Acceleration Time History (Y Direction)

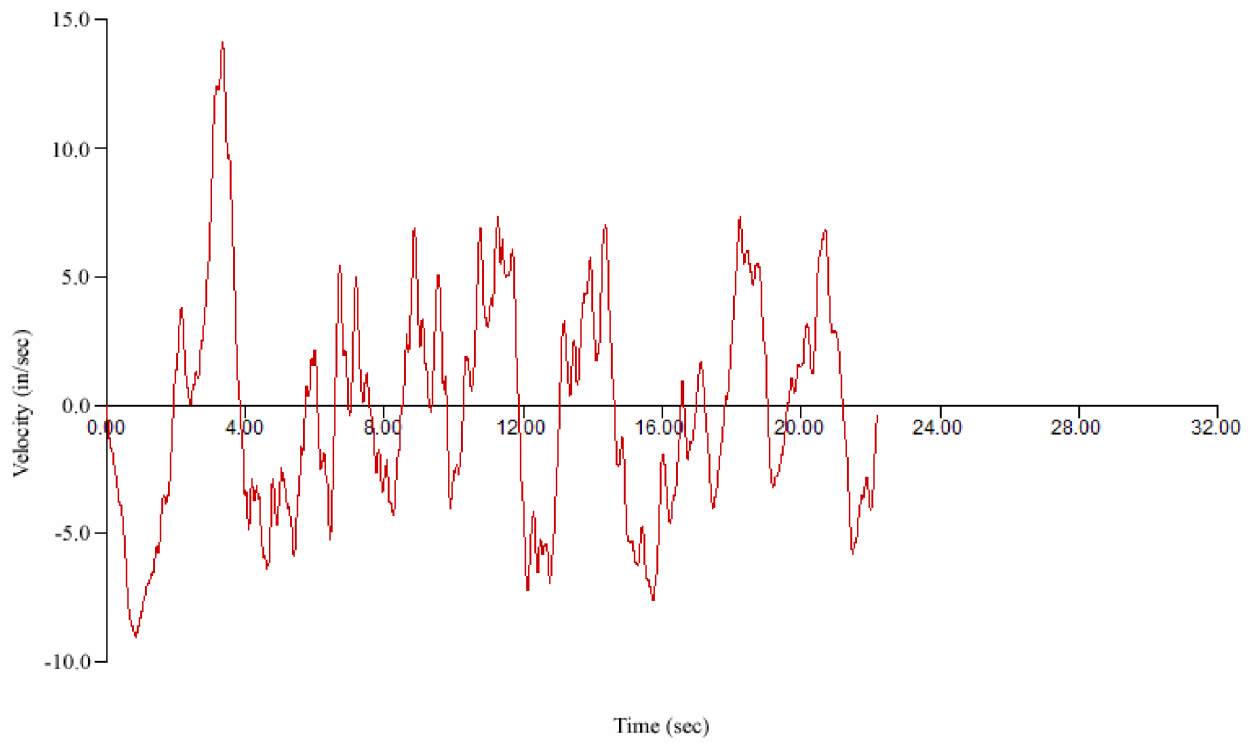

Figure 3A-255 Plot of Velocity Time History (Y Direction)

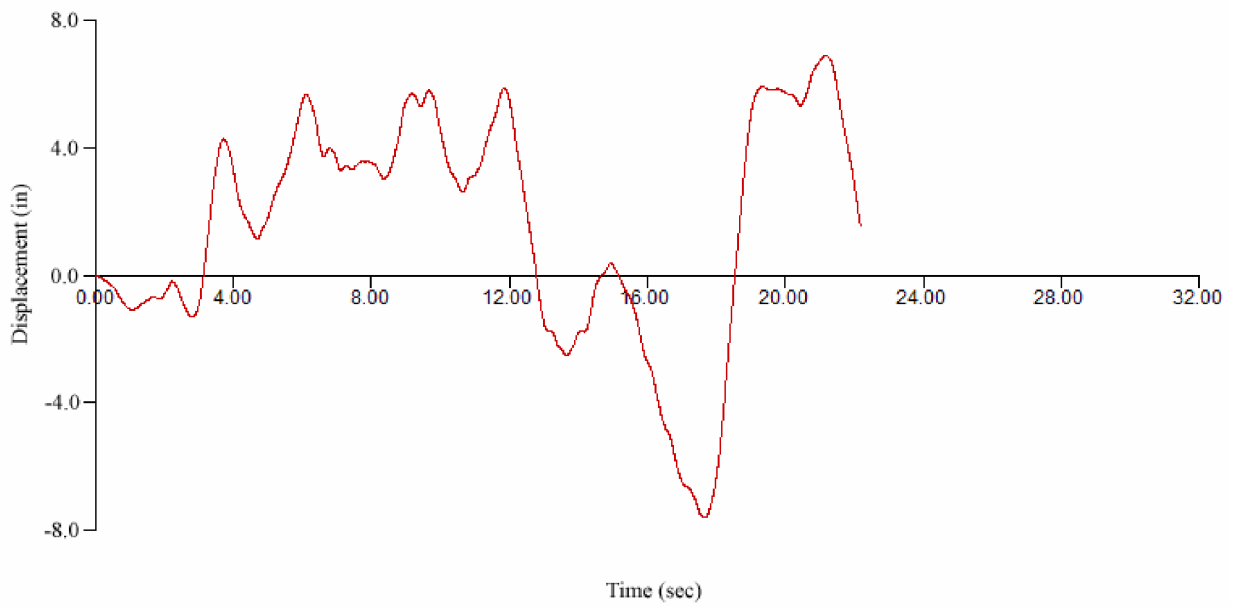

Figure 3A-256 Plot of Displacement Time History (Y Direction)

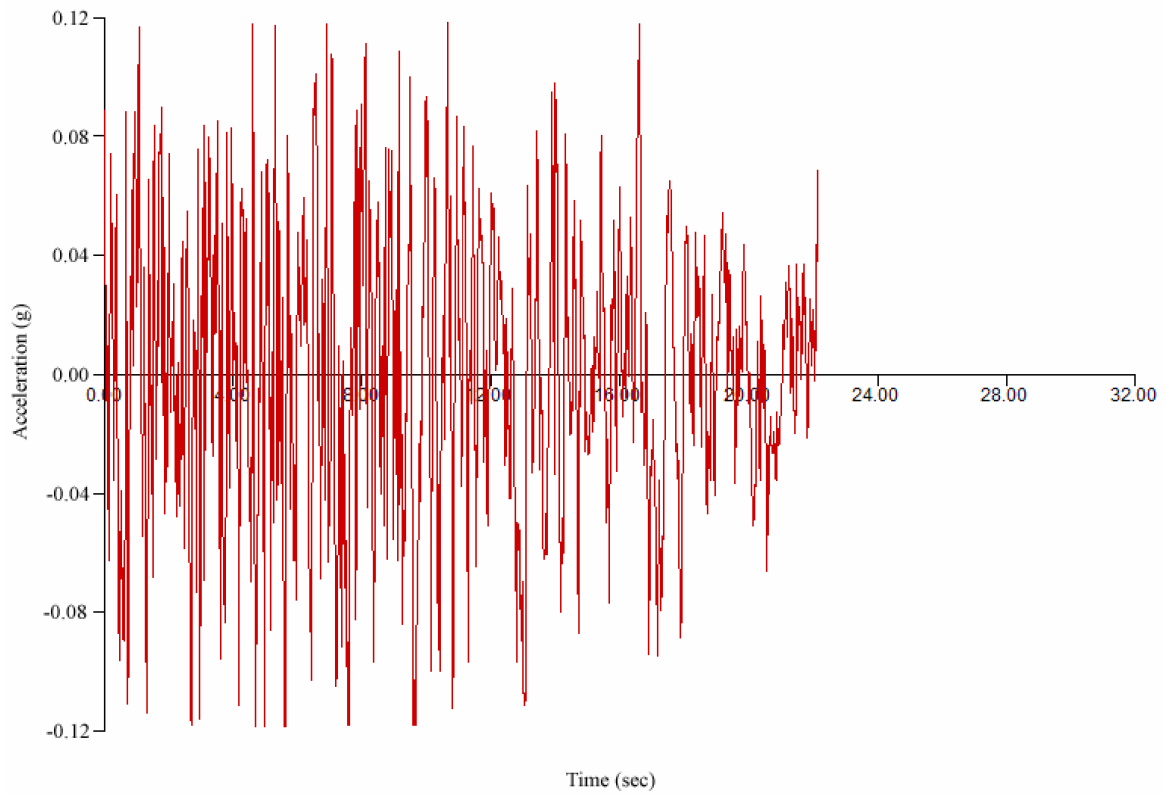

Figure 3A-257 Plot of Acceleration Time History (Vertical Direction)



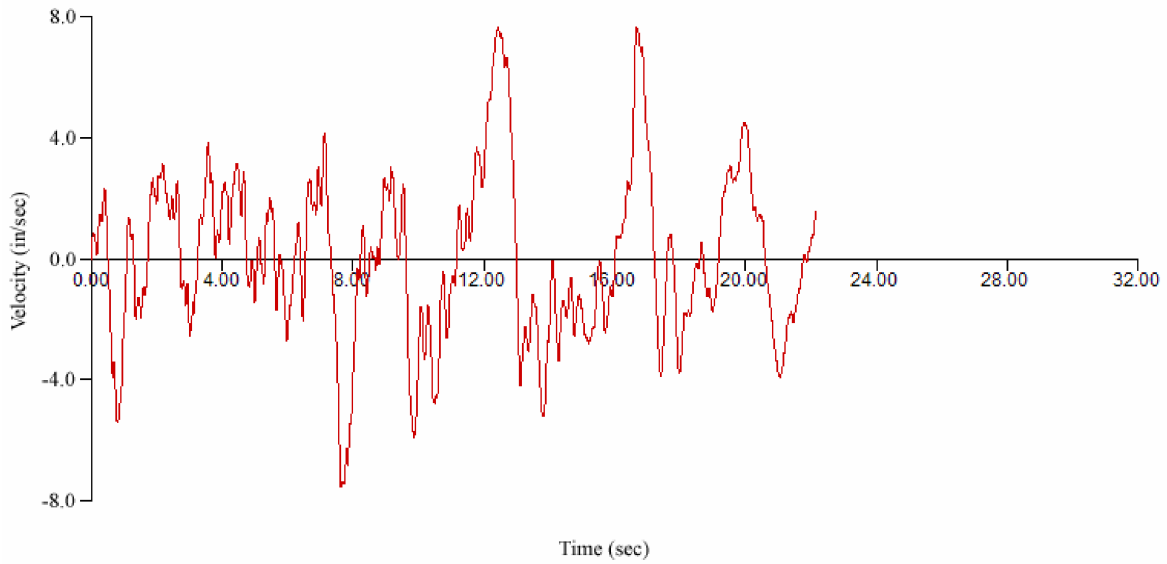

Figure 3A-258 Plot of Velocity Time History (Vertical Direction)

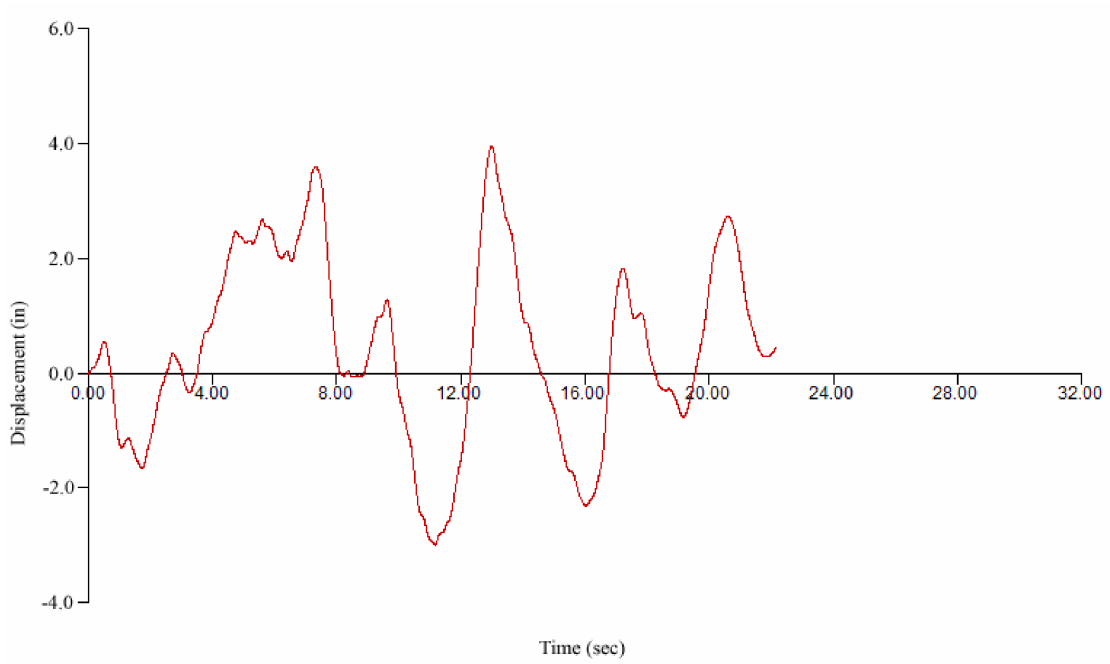

Figure 3A-259 Plot of Displacement Time History (Vertical Direction)

**Figure 3A-260 Not Used**

**Figure 3A-261 Not Used**

**Figure 3A-262 Not Used**

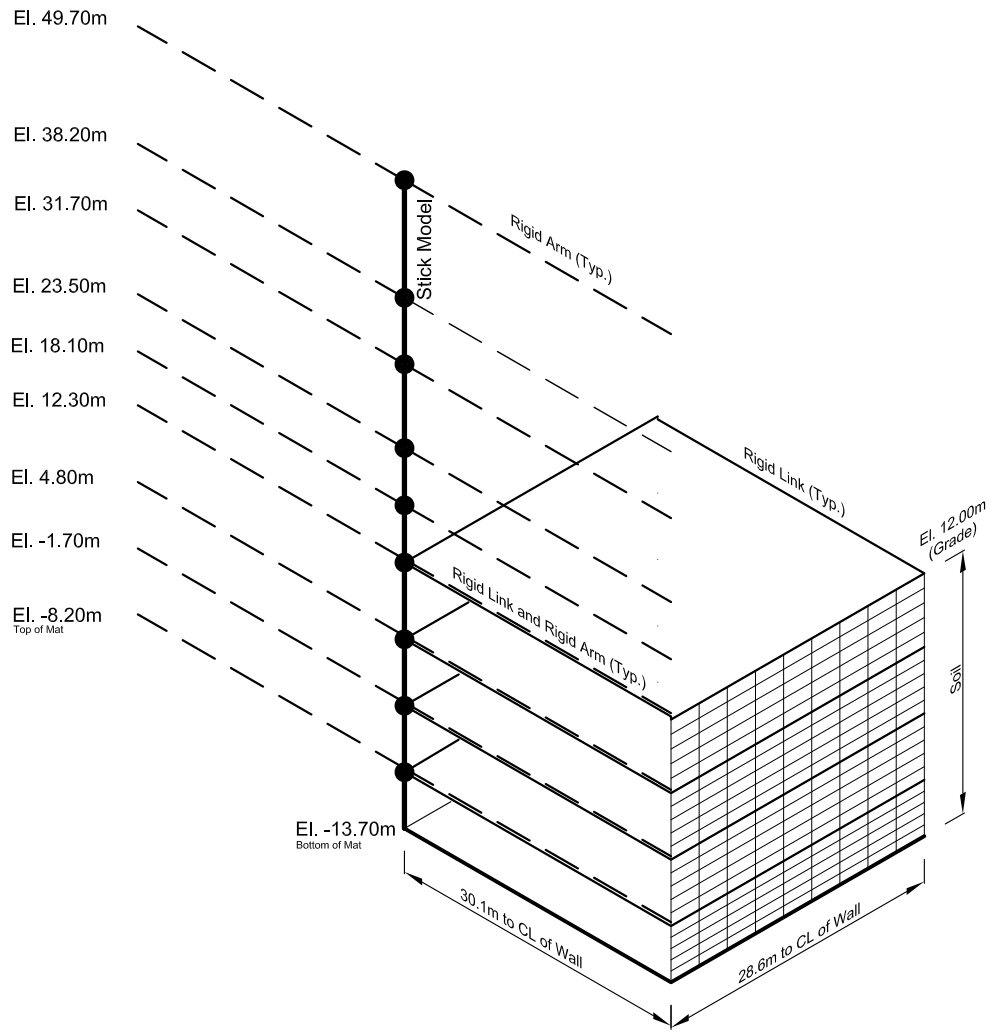

Figure 3A-263 Reactor Building SASSI2000 Model

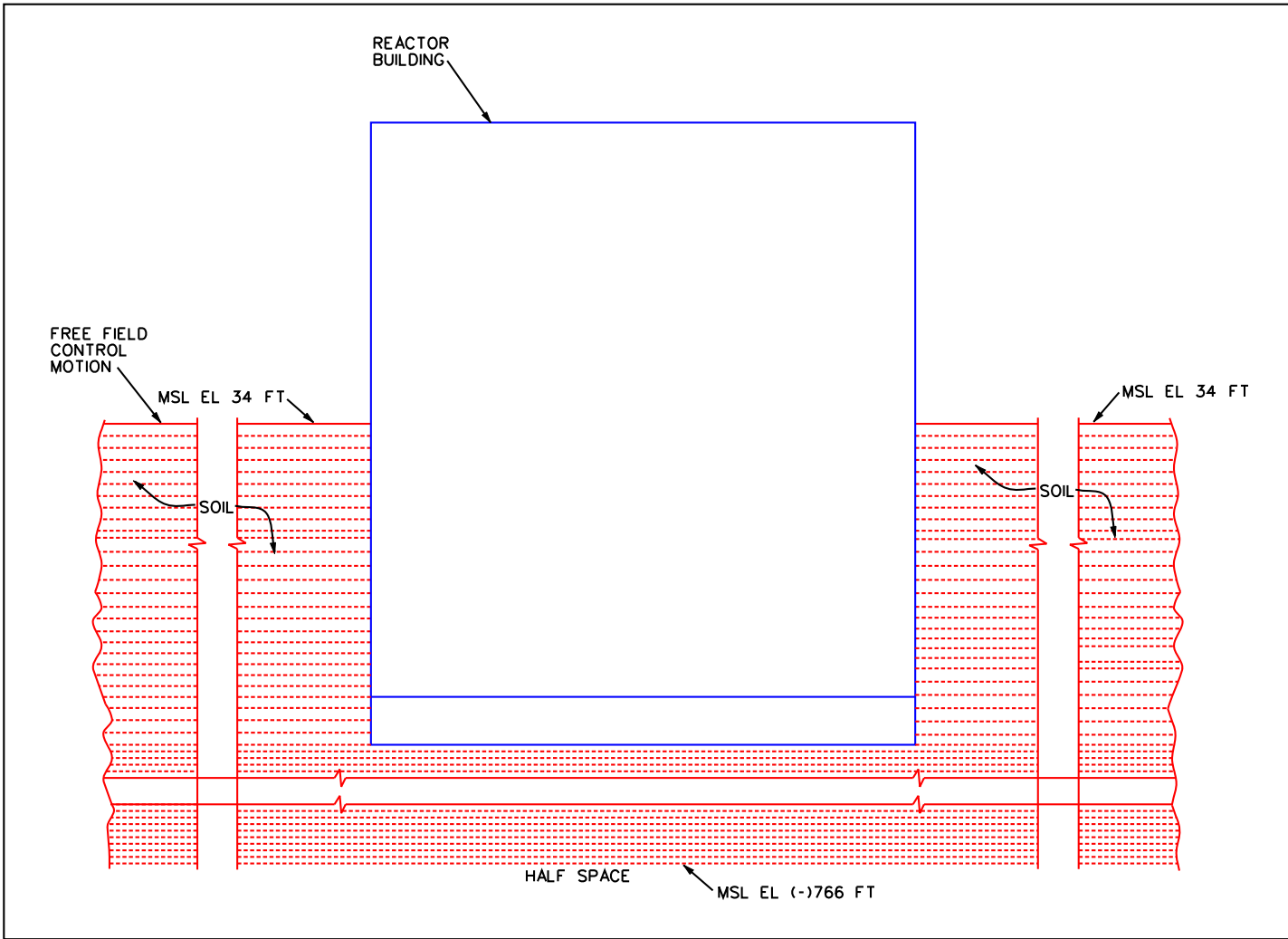

Figure 3A-264 Composite SSI Model of Reactor Building and Soil

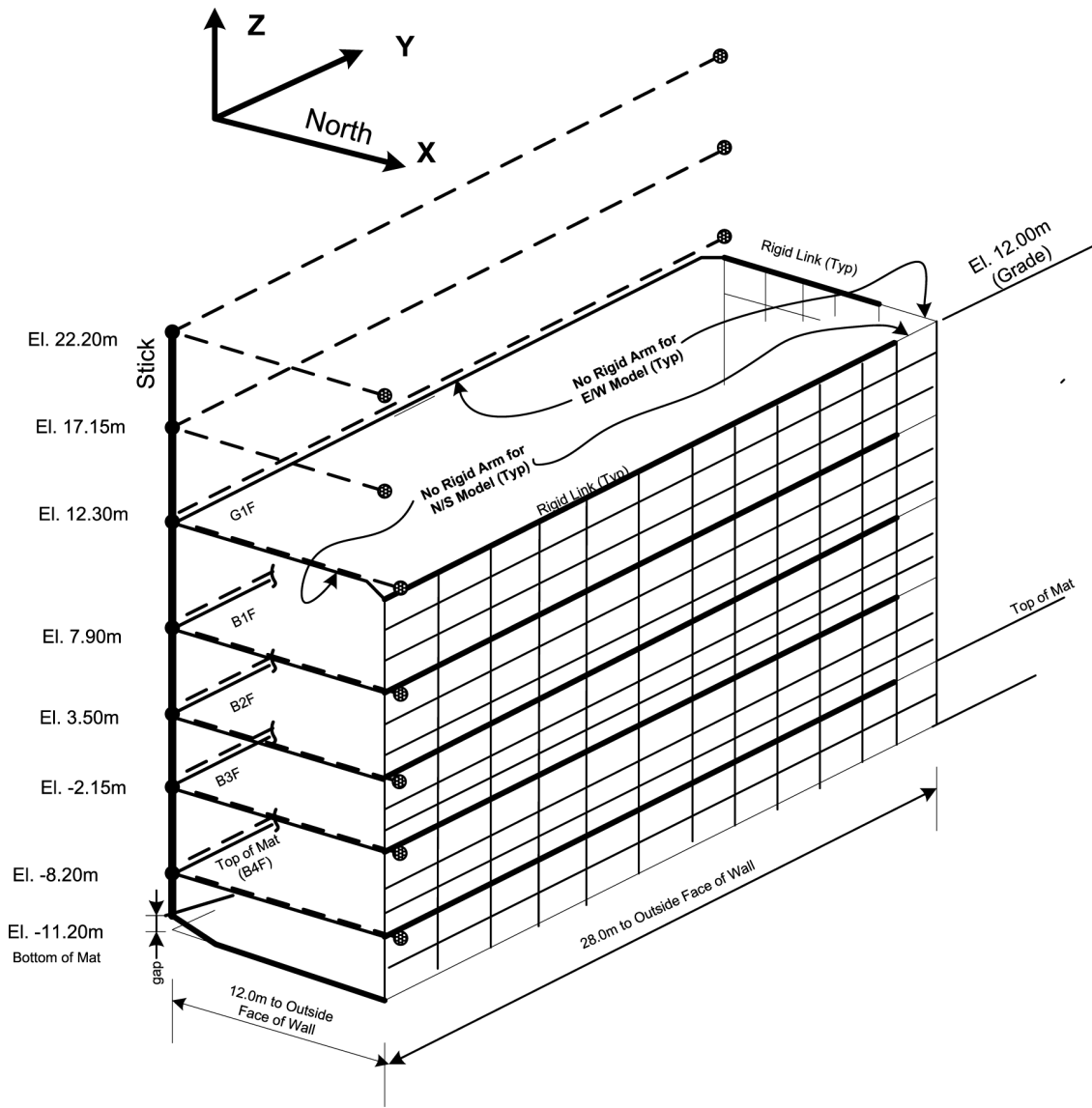

Figure 3A-265 Control Building SASSI2000 Model

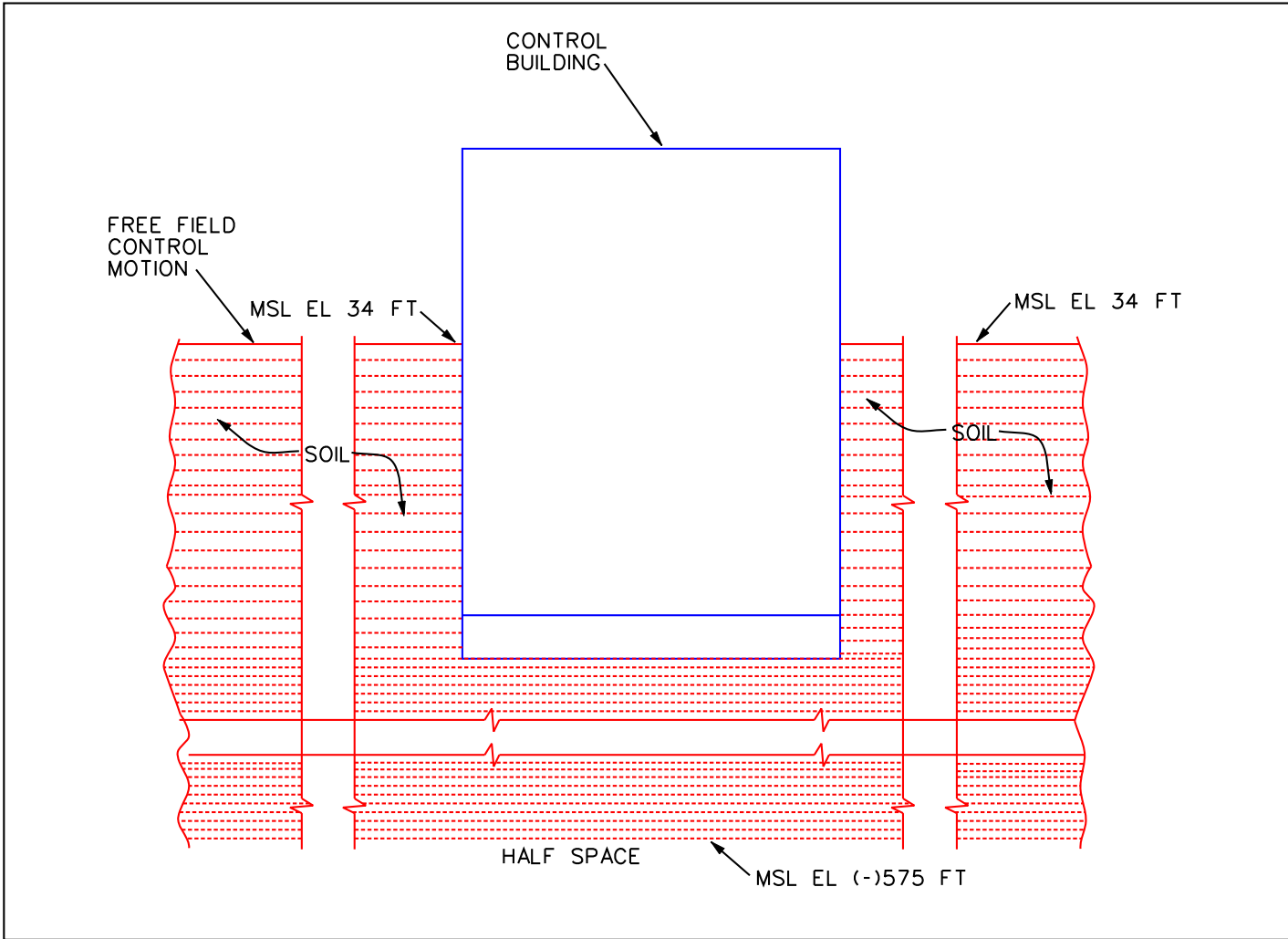

Figure 3A-266 Composite SSI Model of Control Building and Soil



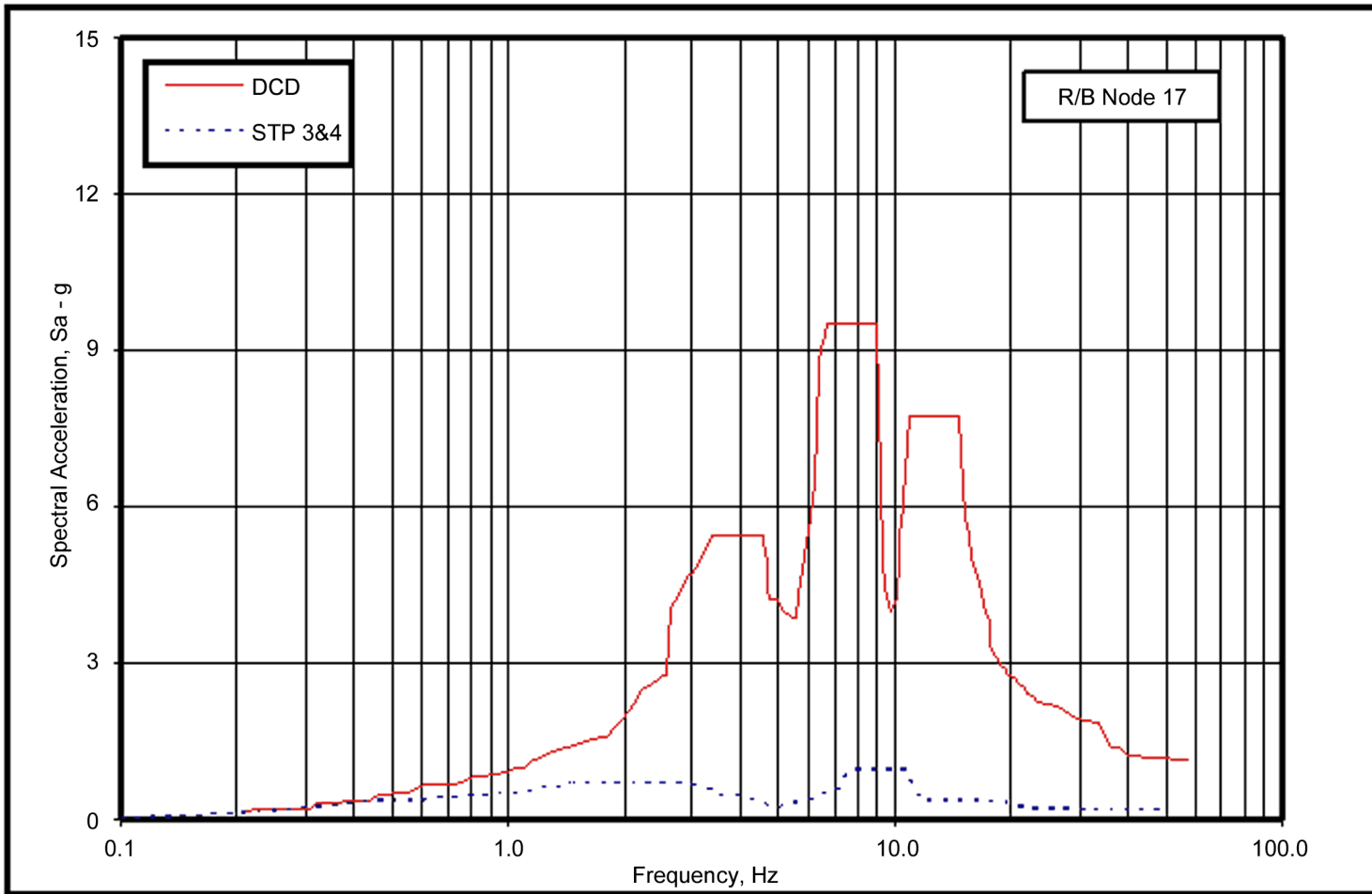
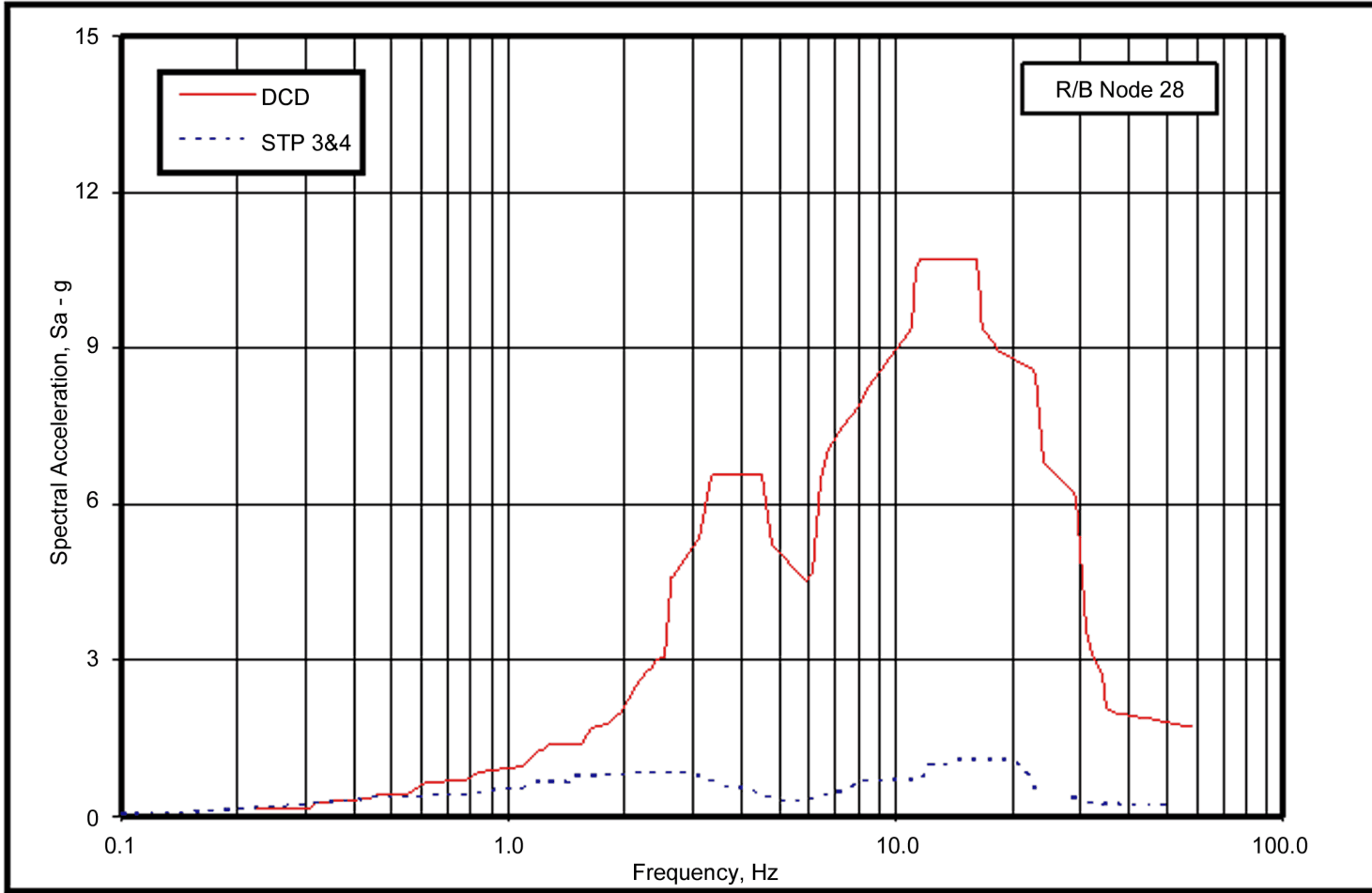

Figure 3A-267 Comparison of Reactor Building Broadened DCD and STP 3&4 Spectra Node 17 - Horizontal, 2% Damping (For Node locations, see DCD Figures 3A-8 and 3A-10)

Note: Horizontal Spectra are the envelopes of X and Y direction spectra



**Figure 3A-268 Comparison of Reactor Building Broadened DCD and STP 3&4 Spectra Node 28 - Horizontal, 2% Damping (For Node locations, see DCD Figures 3A-8 and 3A-10)**

Note: Horizontal Spectra are the envelopes of X and Y direction spectra

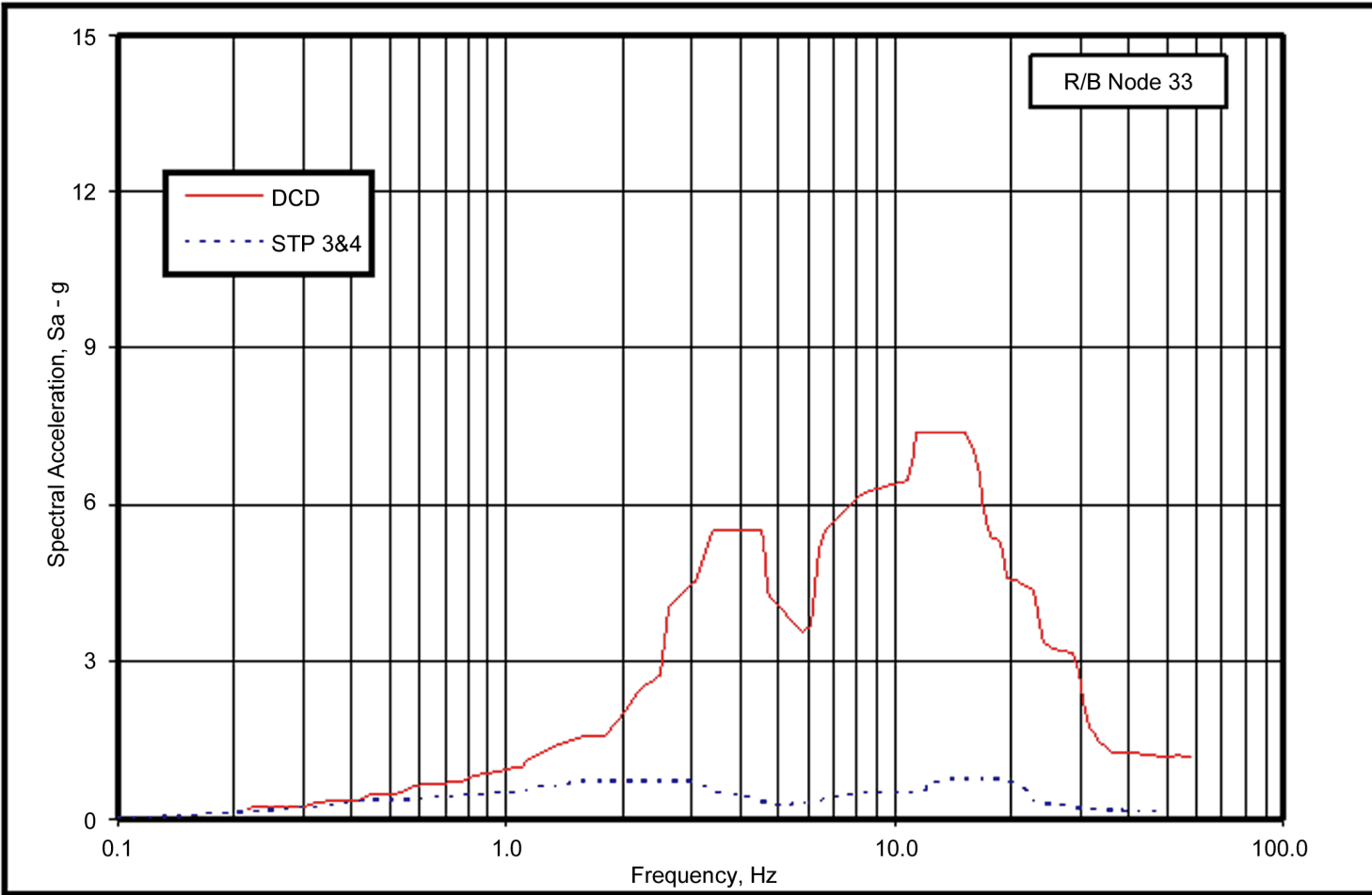

Figure 3A-269 Comparison of Reactor Building Broadened DCD and STP 3&4 Spectra Node 33 - Horizontal, 2% Damping (For Node locations, see DCD Figures 3A-8 and 3A-10)

Note: Horizontal Spectra are the envelopes of X and Y direction spectra

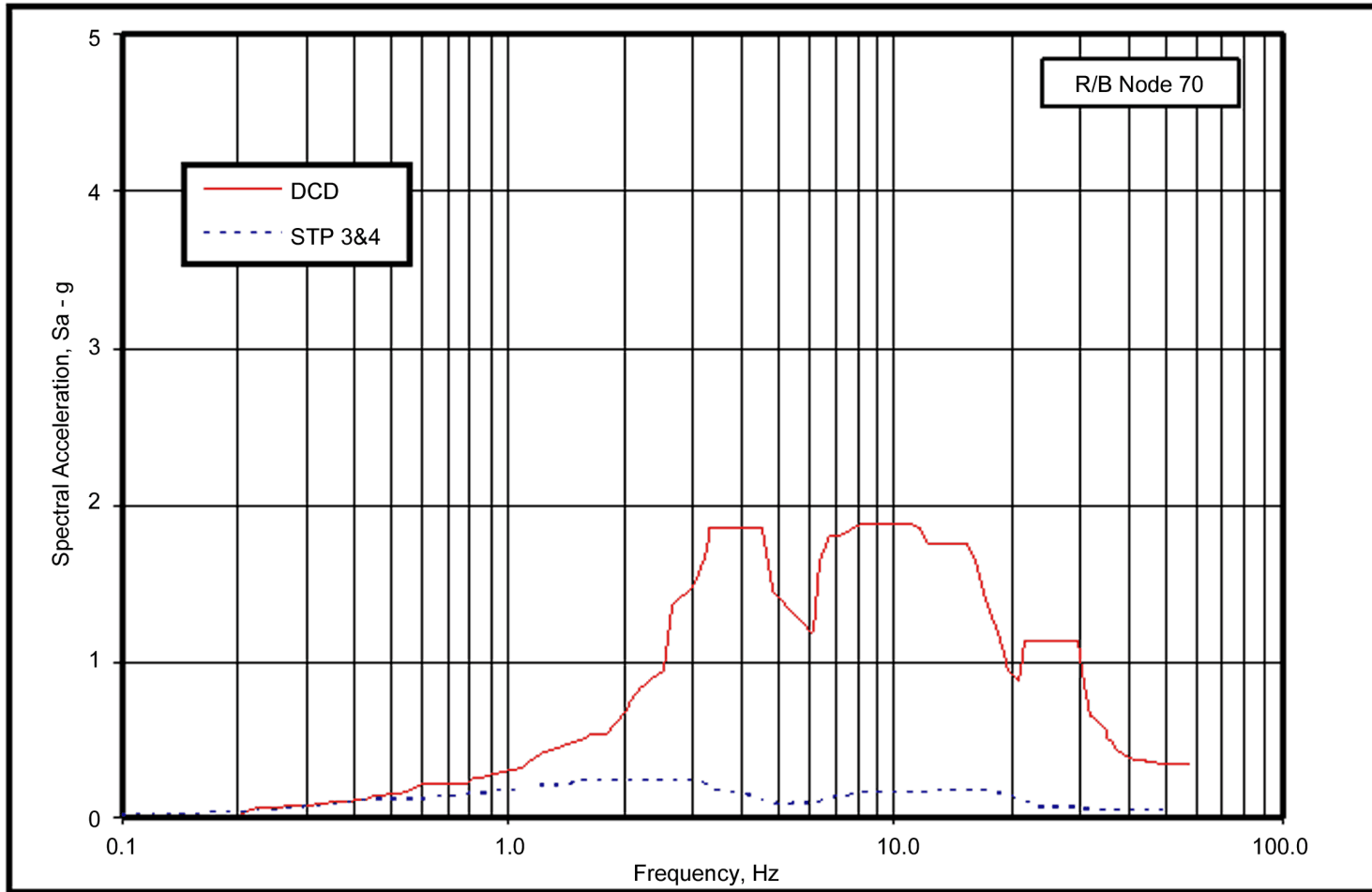

Figure 3A-270 Comparison of Reactor Building Broadened DCD and STP 3&4 Spectra Node 70 - Horizontal, 2% Damping (For Node locations, see DCD Figures 3A-8 and 3A-10)

Note: Horizontal Spectra are the envelopes of X and Y direction spectra

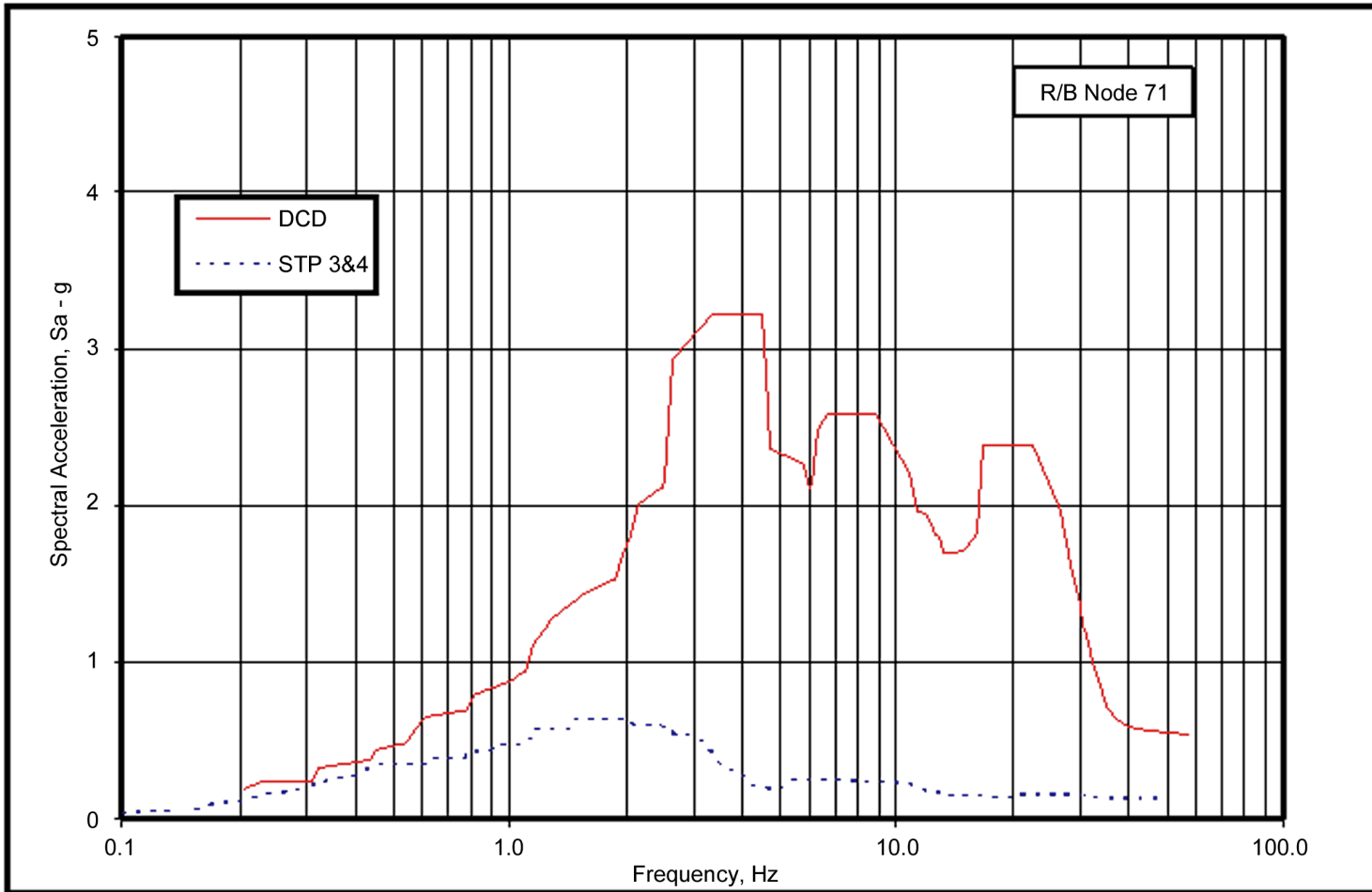
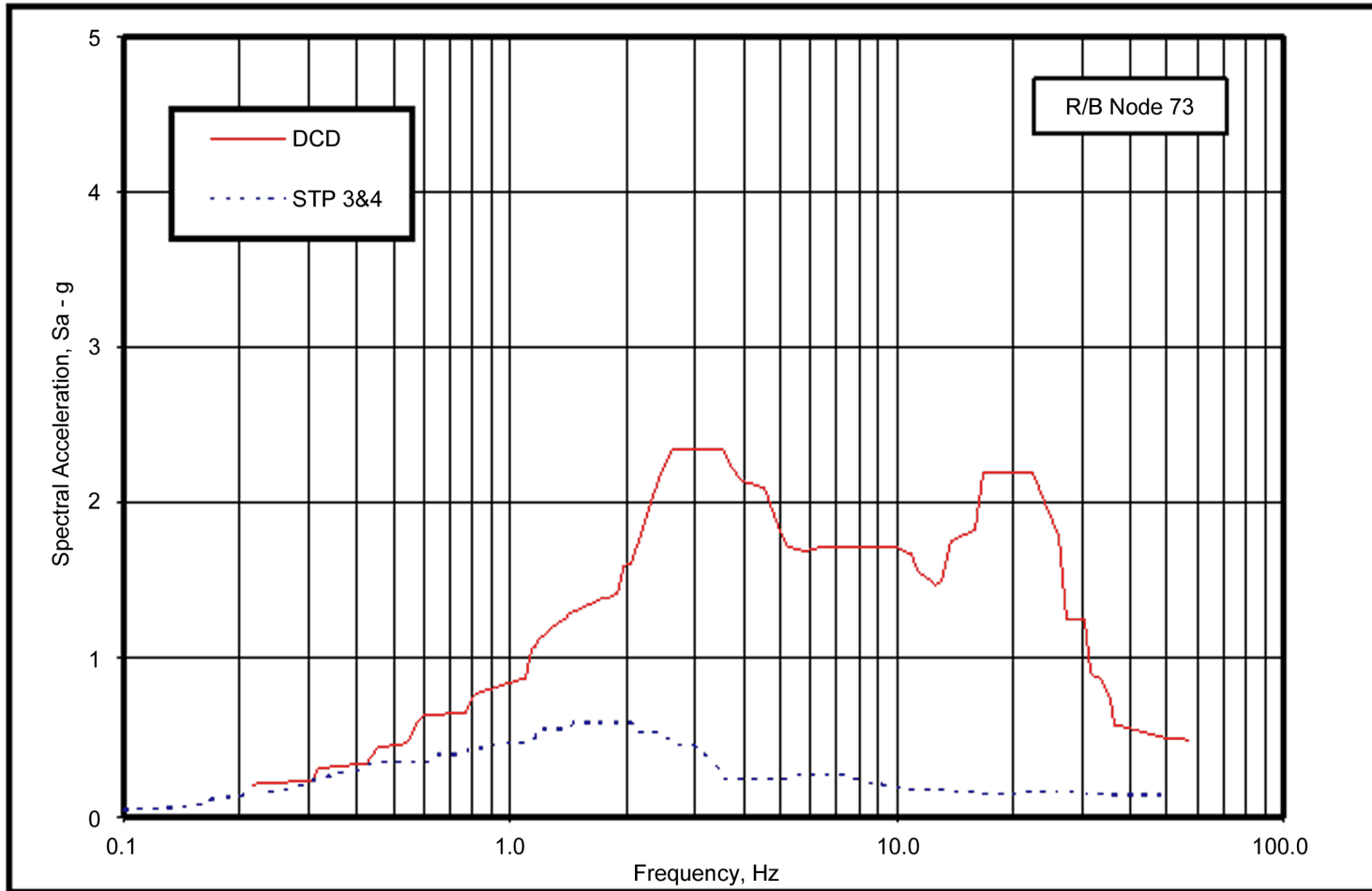

Figure 3A-271 Comparison of Reactor Building Broadened DCD and STP 3&4 Spectra Node 71 - Horizontal, 2% Damping (For Node locations, see DCD Figures 3A-8 and 3A-10)

Note: Horizontal Spectra are the envelopes of X and Y direction spectra



**Figure 3A-272 Comparison of Reactor Building Broadened DCD and STP 3&4 Spectra Node 73 - Horizontal, 2% Damping (For Node locations, see DCD Figures 3A-8 and 3A-10)**

Note: Horizontal Spectra are the envelopes of X and Y direction spectra

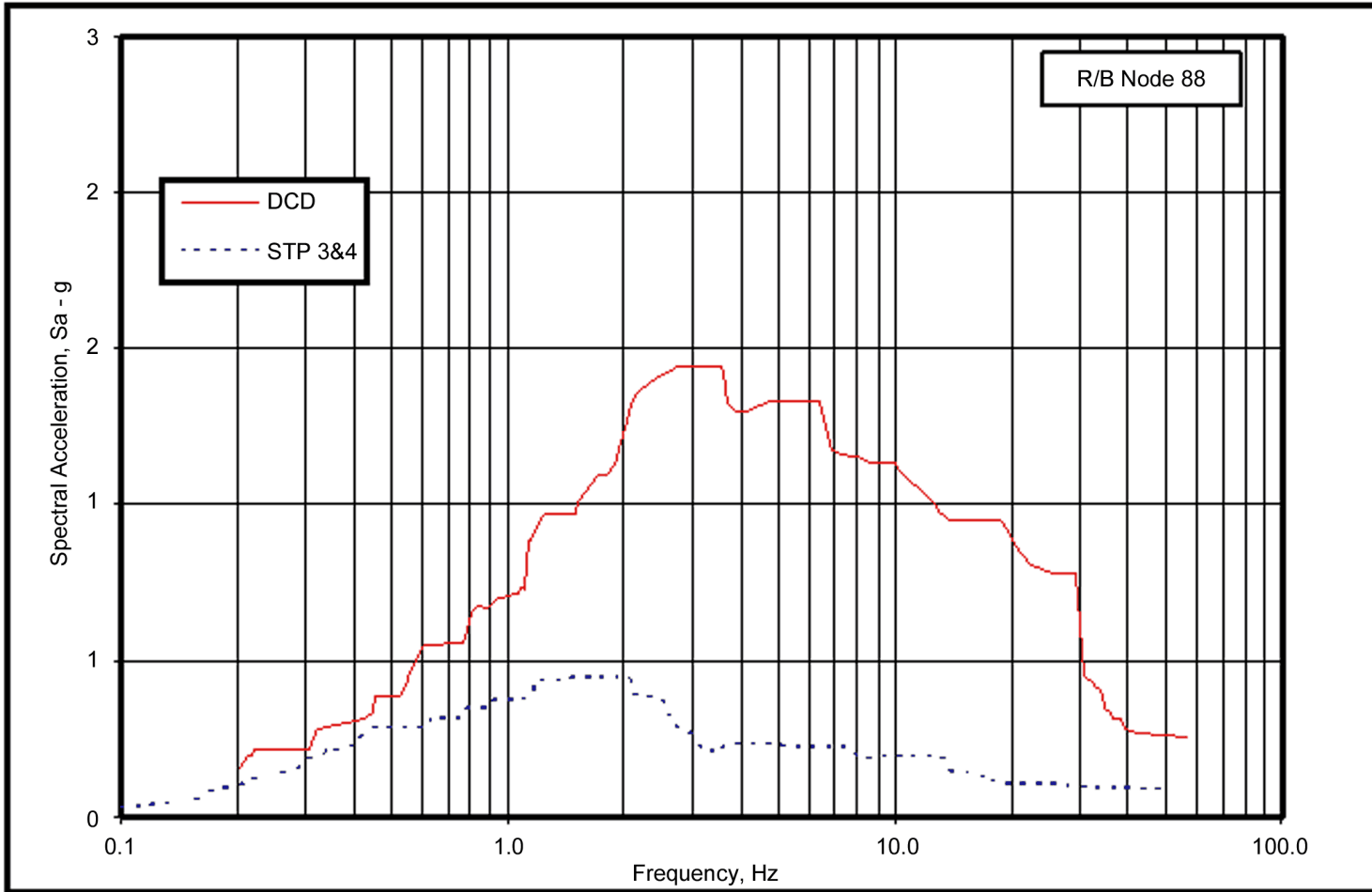
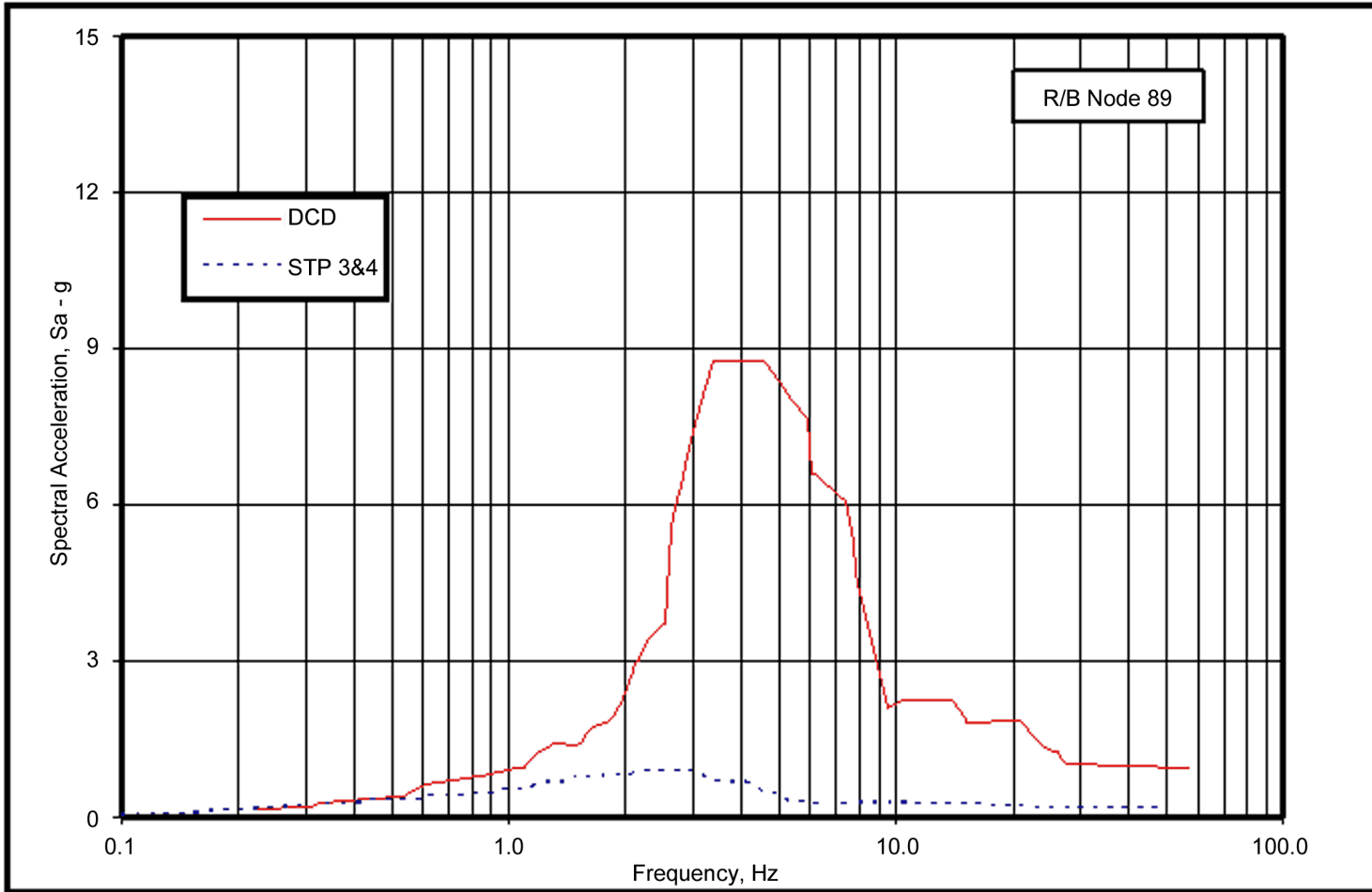

Figure 3A-273 Comparison of Reactor Building Broadened DCD and STP 3&4 Spectra Node 88 - Horizontal, 2% Damping (For Node locations, see DCD Figures 3A-8 and 3A-10)

Note: Horizontal Spectra are the envelopes of X and Y direction spectra



**Figure 3A-274 Comparison of Reactor Building Broadened DCD and STP 3&4 Spectra Node 89 - Horizontal, 2% Damping (For Node locations, see DCD Figures 3A-8 and 3A-10)**

Note: Horizontal Spectra are the envelopes of X and Y direction spectra



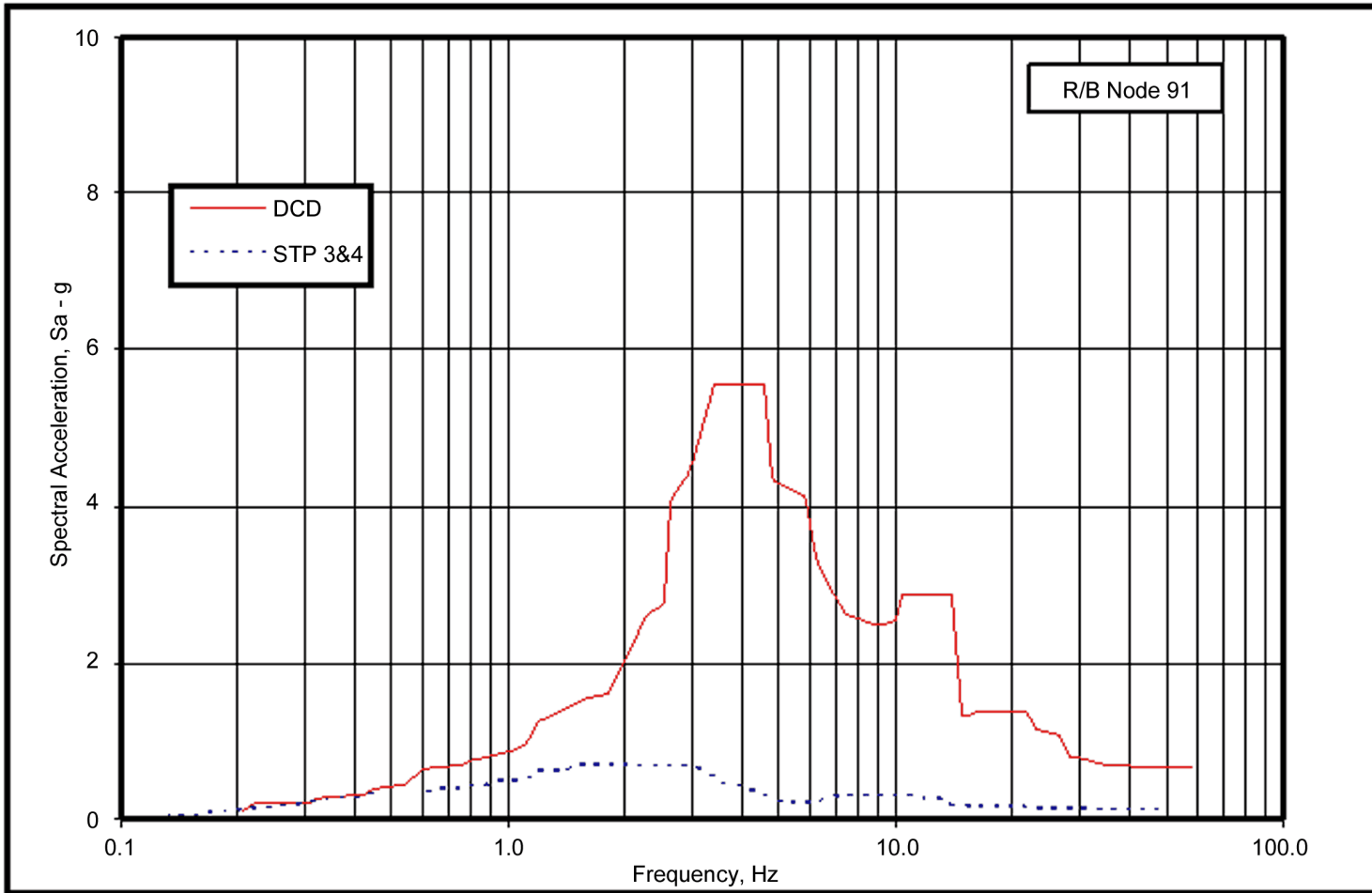
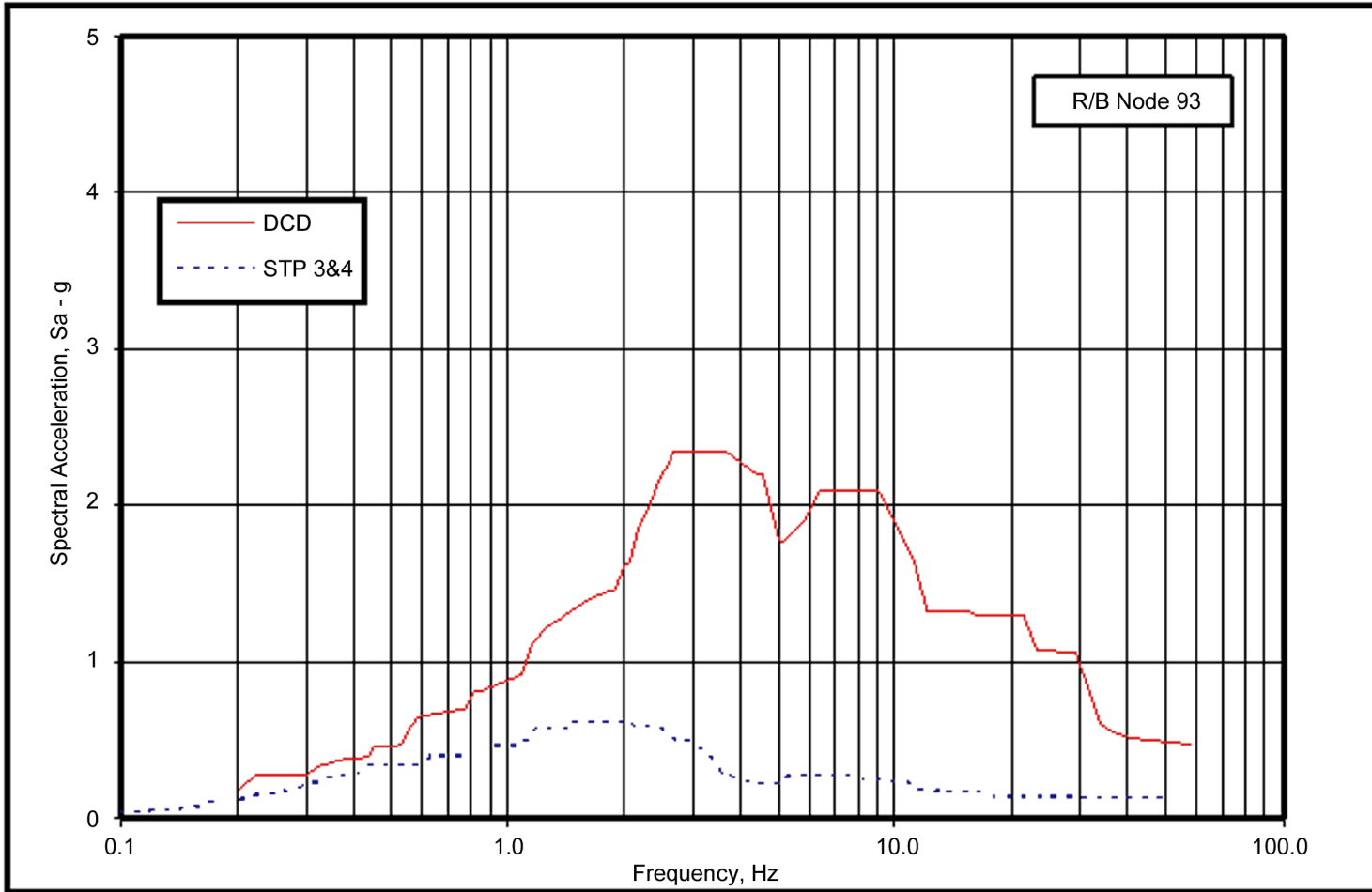

Figure 3A-275 Comparison of Reactor Building Broadened DCD and STP 3&4 Spectra Node 91 - Horizontal, 2% Damping (For Node locations, see DCD Figures 3A-8 and 3A-10)

Note: Horizontal Spectra are the envelopes of X and Y direction spectra



**Figure 3A-276 Comparison of Reactor Building Broadened DCD and STP 3&4 Spectra Node 93 - Horizontal, 2% Damping (For Node locations, see DCD Figures 3A-8 and 3A-10)**

Note: Horizontal Spectra are the envelopes of X and Y direction spectra

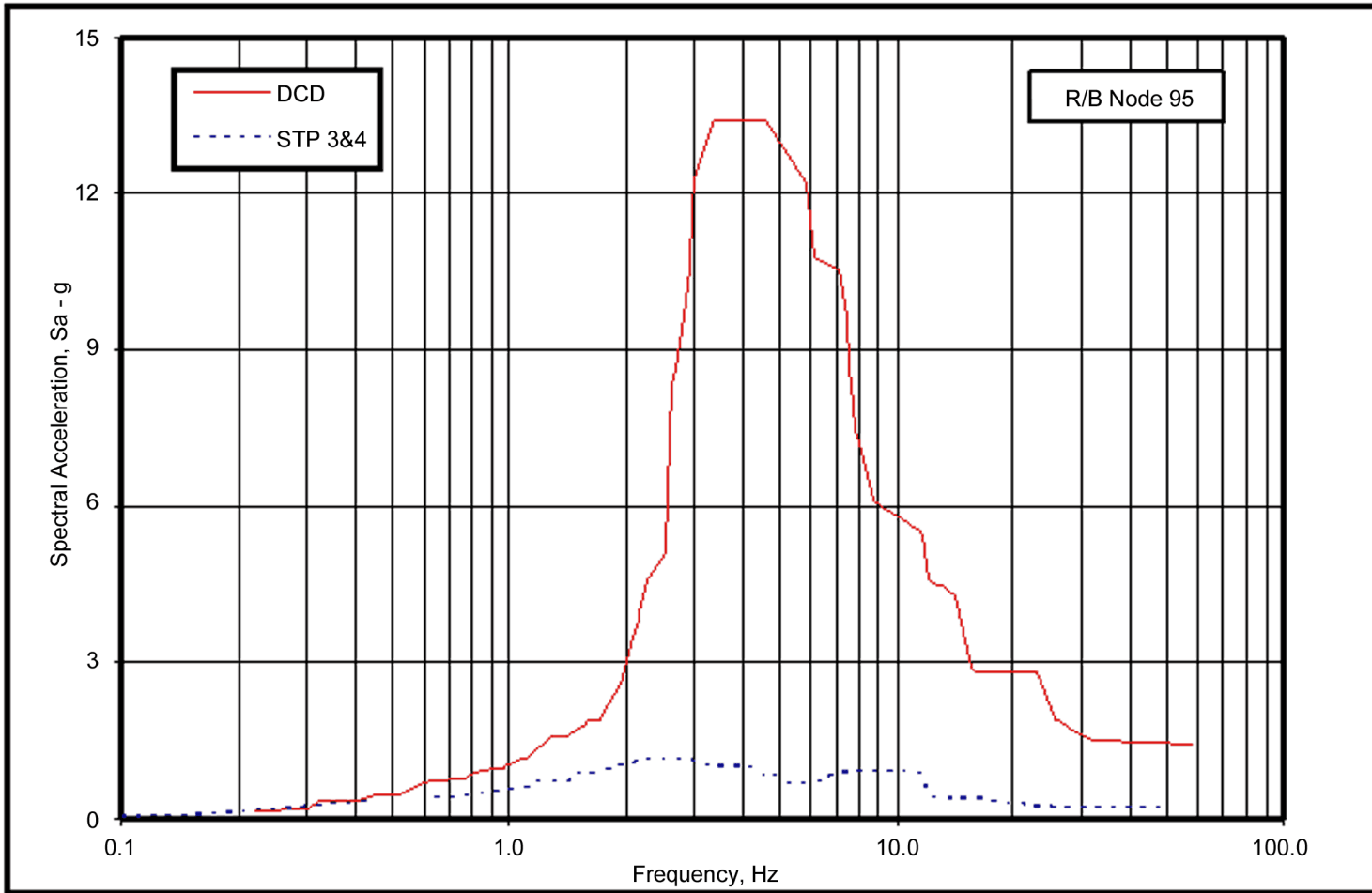
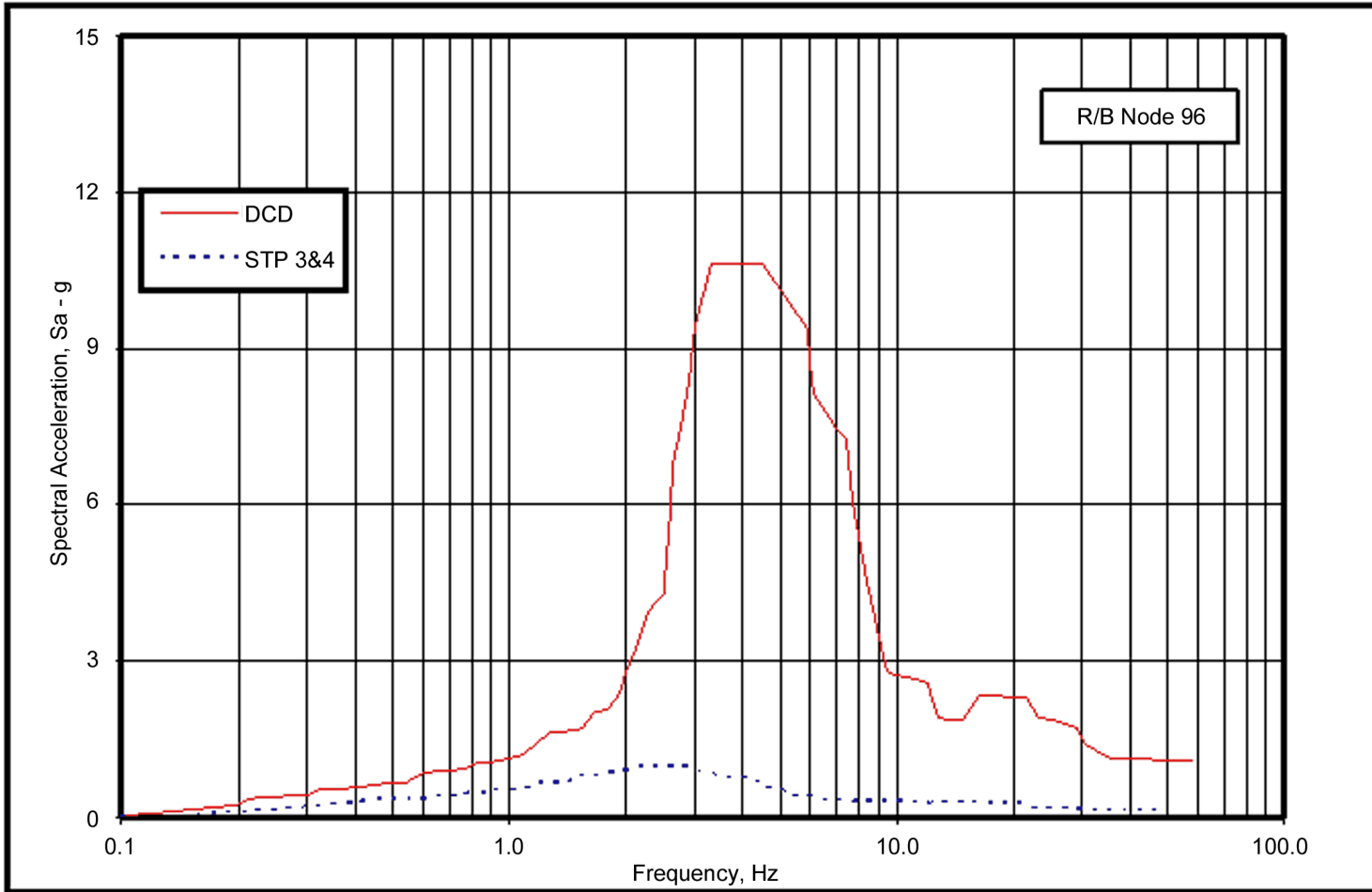

Figure 3A-277 Comparison of Reactor Building Broadened DCD and STP 3&4 Spectra Node 95 - Horizontal, 2% Damping (For Node locations, see DCD Figures 3A-8 and 3A-10)

Note: Horizontal Spectra are the envelopes of X and Y direction spectra



**Figure 3A-278 Comparison of Reactor Building Broadened DCD and STP 3&4 Spectra Node 96 - Horizontal, 2% Damping (For Node locations, see DCD Figures 3A-8 and 3A-10)**

Note: Horizontal Spectra are the envelopes of X and Y direction spectra

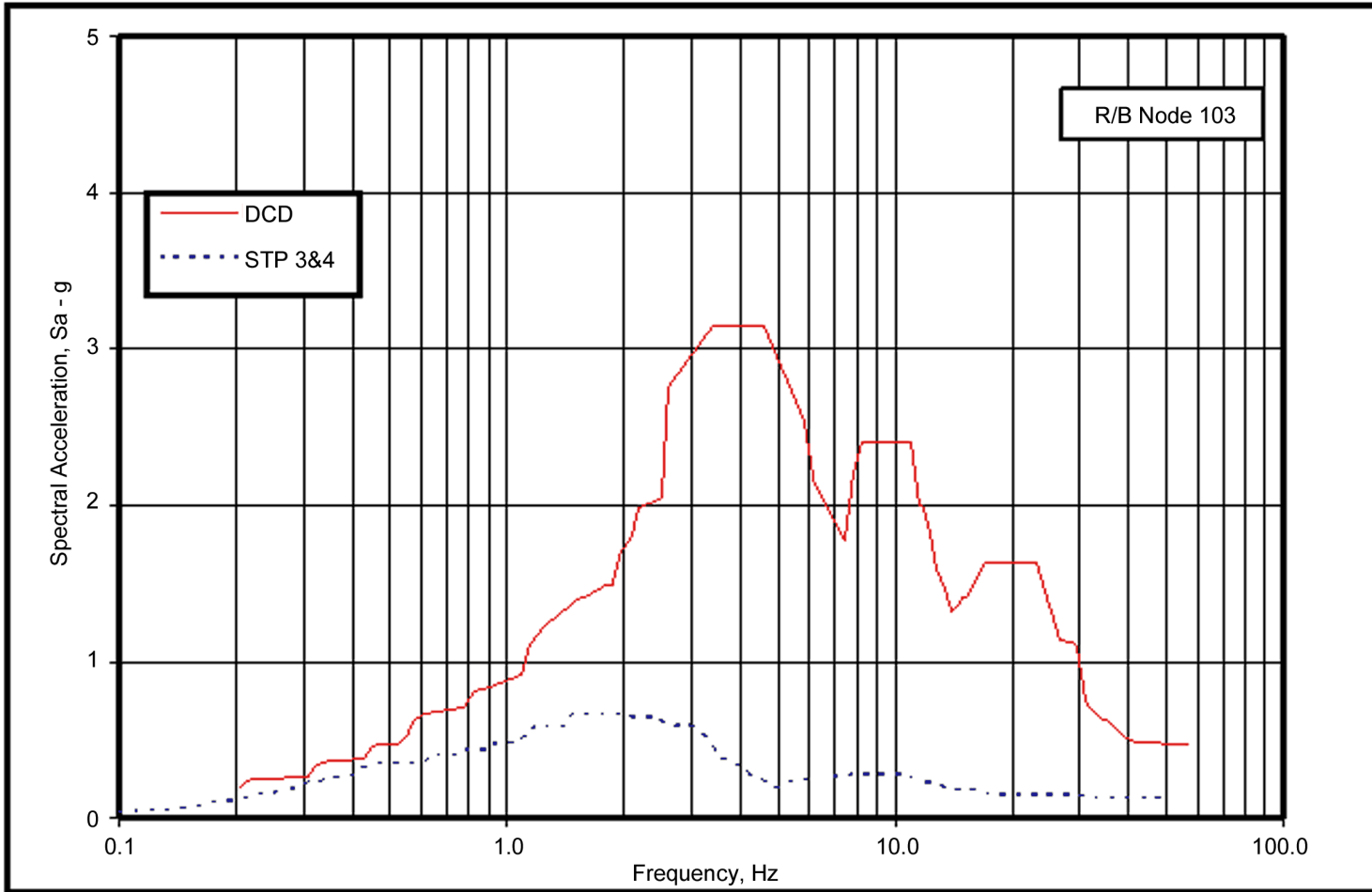

Figure 3A-279 Comparison of Reactor Building Broadened DCD and STP 3&4 Spectra Node 103 - Horizontal, 2% Damping (For Node locations, see DCD Figures 3A-8 and 3A-10)

Note: Horizontal Spectra are the envelopes of X and Y direction spectra

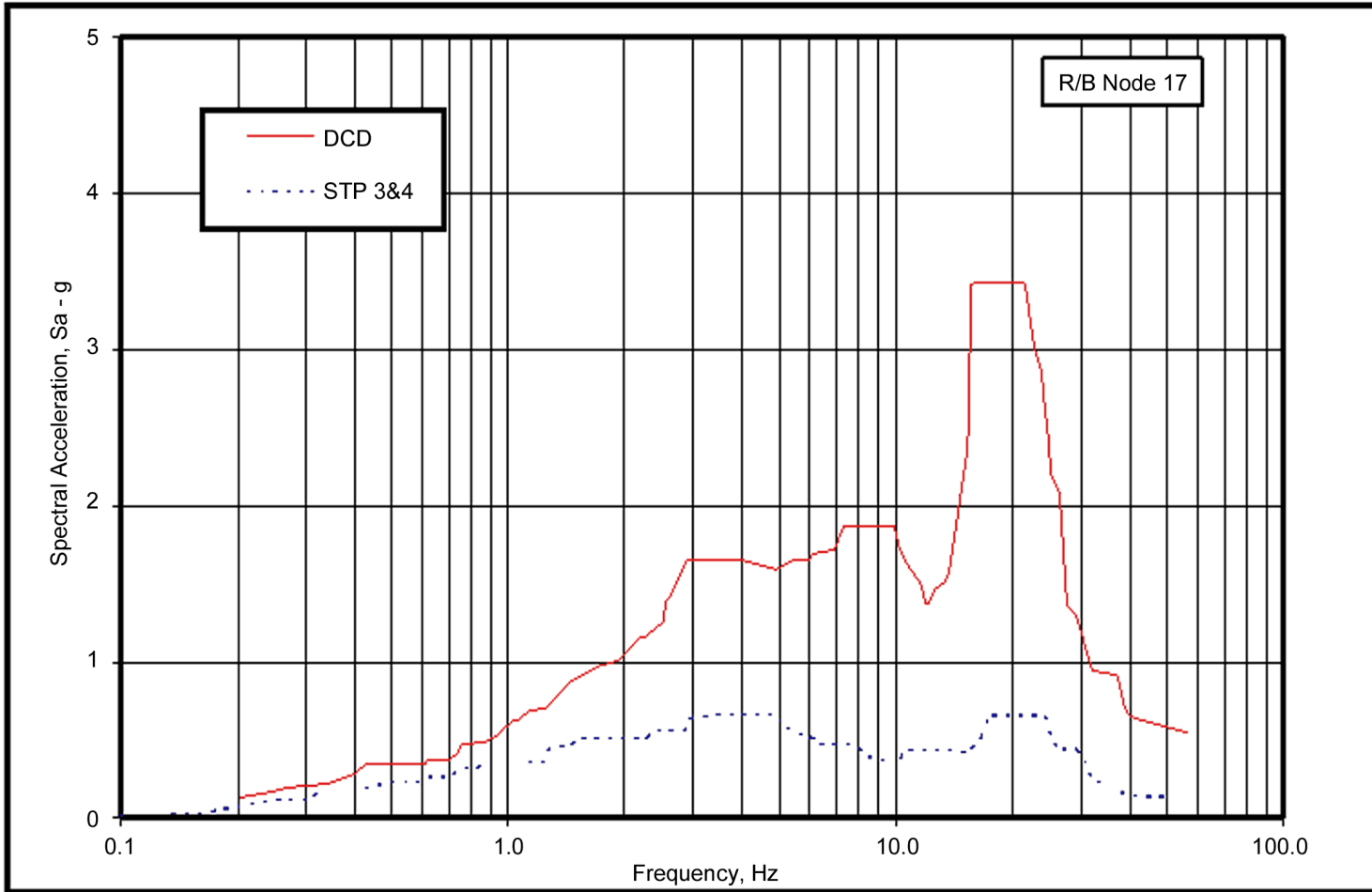

Figure 3A-280 Comparison of Reactor Building Broadened DCD and STP 3&4 Spectra Node 17 - Vertical, 2% Damping (For Node locations, see DCD Figures 3A-8 and 3A-10)

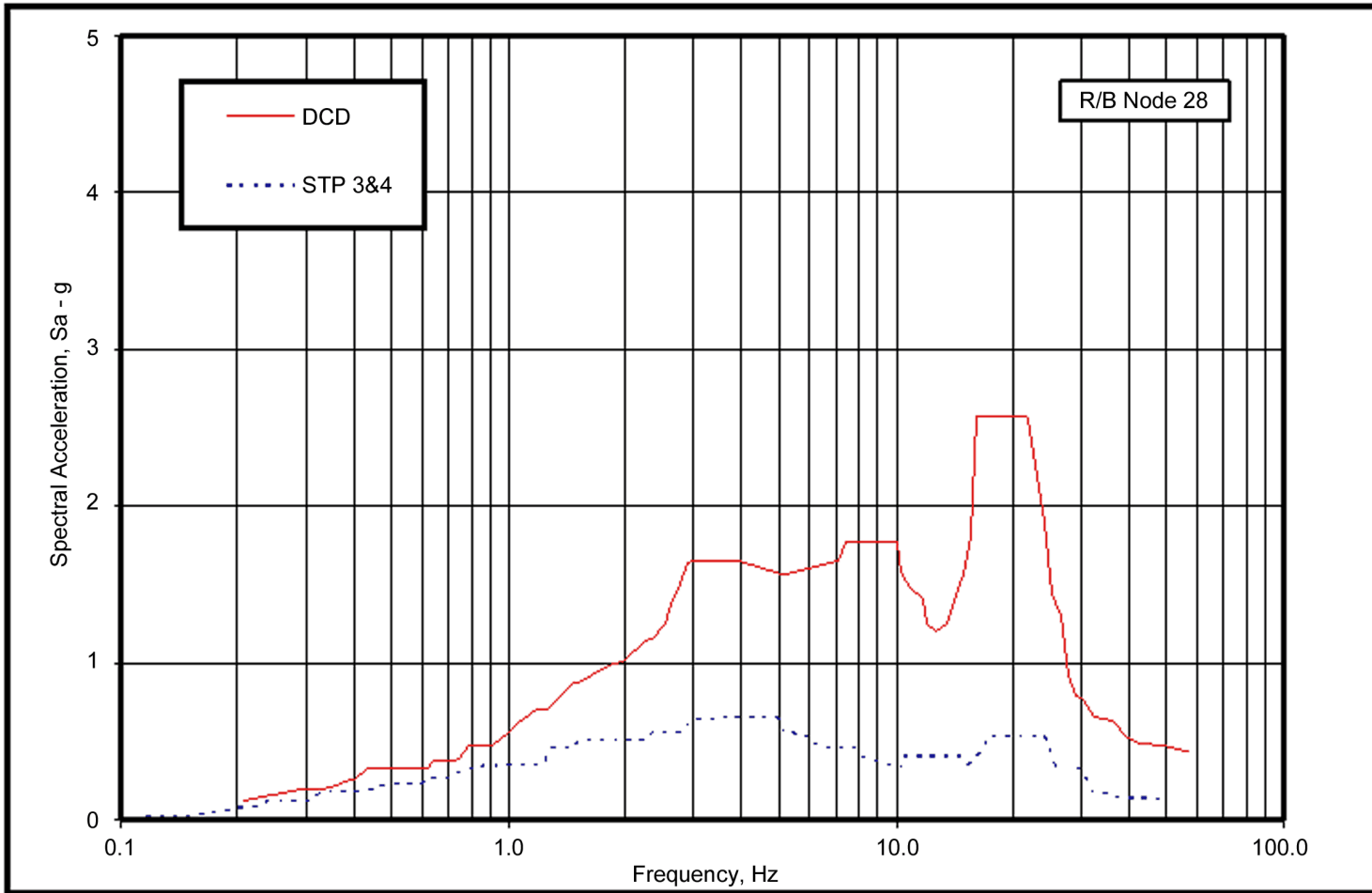

Figure 3A-281 Comparison of Reactor Building Broadened DCD and STP 3&4 Spectra Node 28 - Vertical, 2% Damping (For Node locations, see DCD Figures 3A-8 and 3A-10)

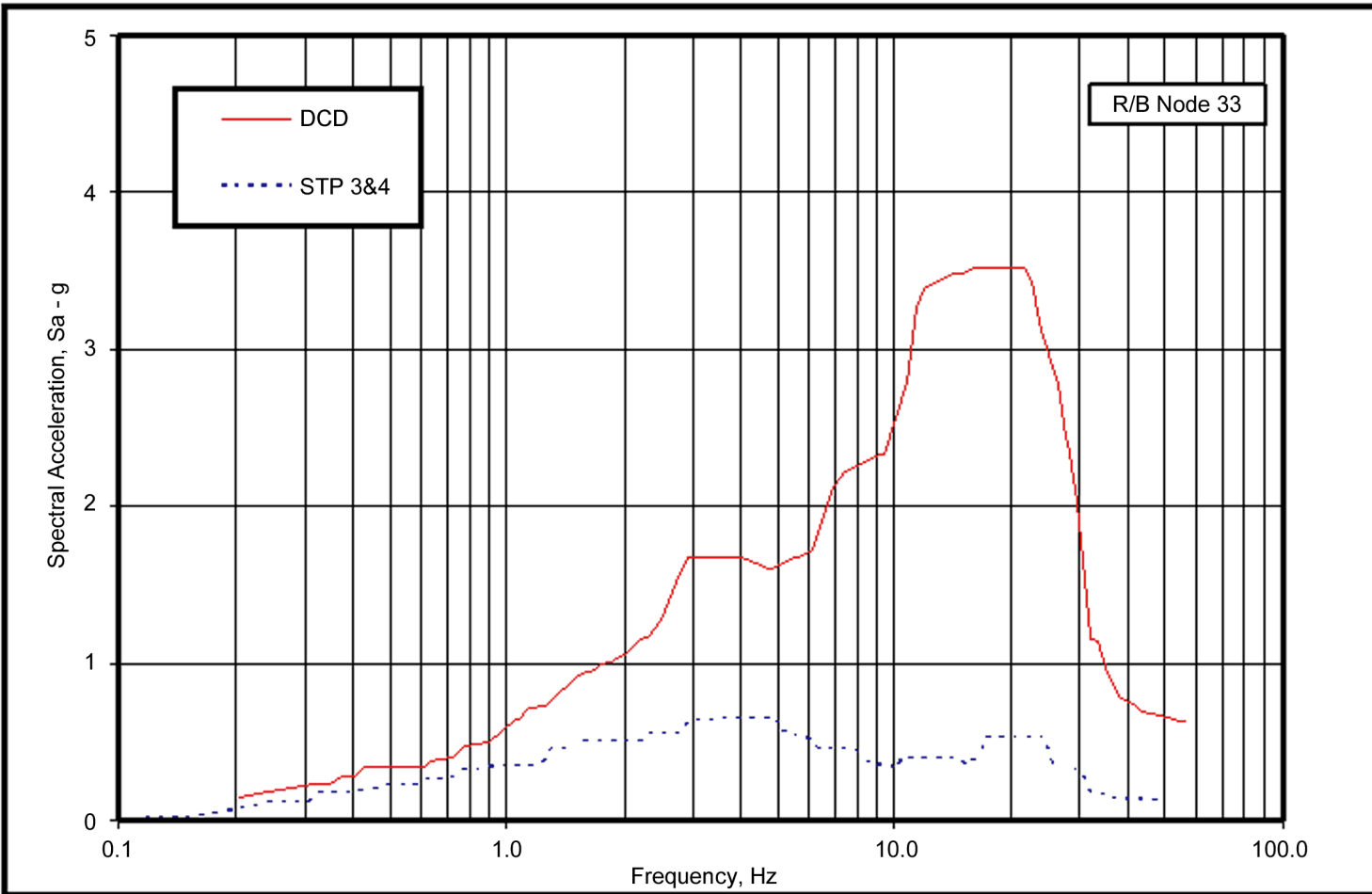

Figure 3A-282 Comparison of Reactor Building Broadened DCD and STP 3&4 Spectra Node 33 - Vertical, 2% Damping (For Node locations, see DCD Figures 3A-8 and 3A-10)



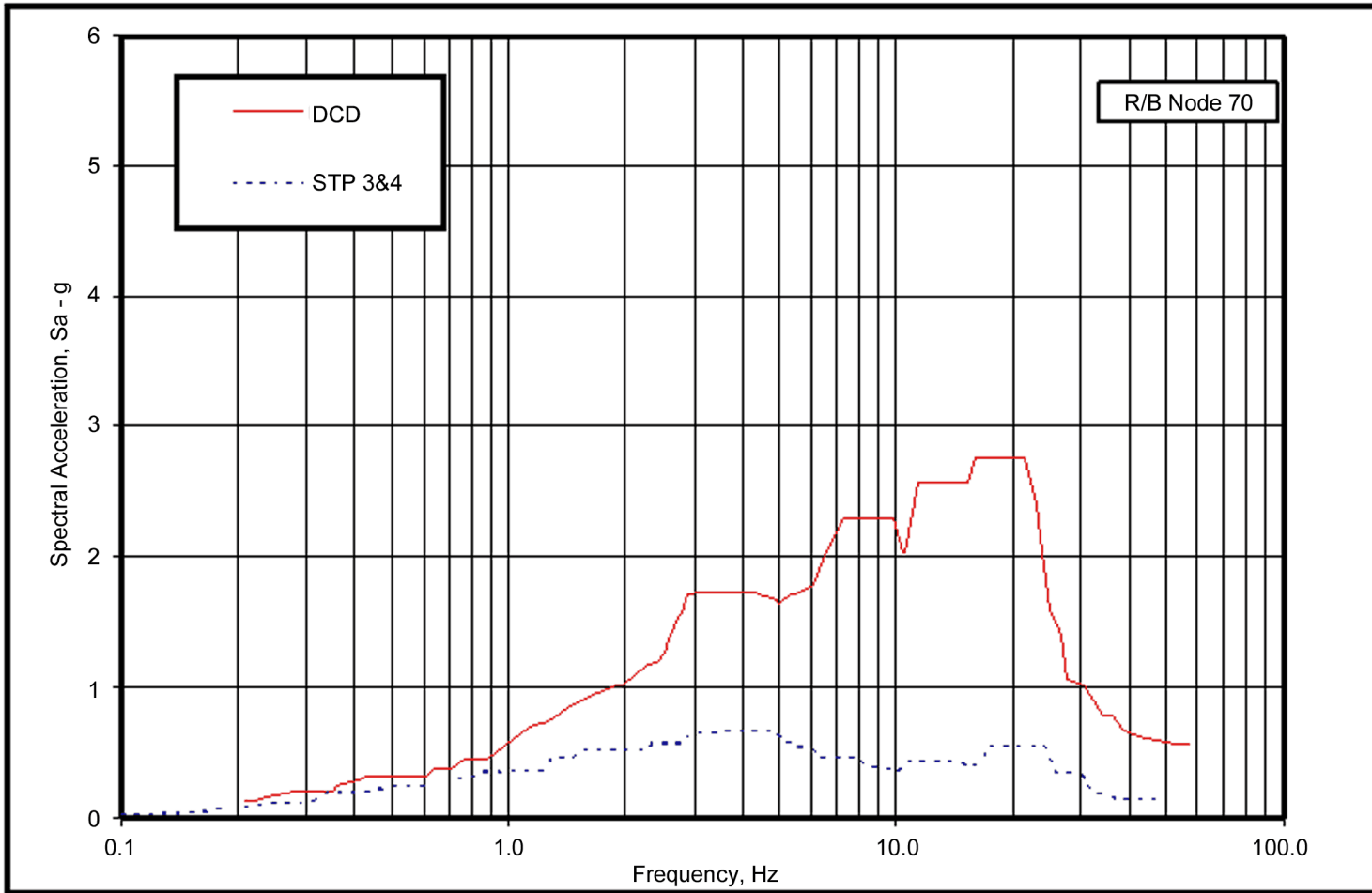

Figure 3A-283 Comparison of Reactor Building Broadened DCD and STP 3&4 Spectra Node 70 - Vertical, 2% Damping (For Node locations, see DCD Figures 3A-8 and 3A-10)

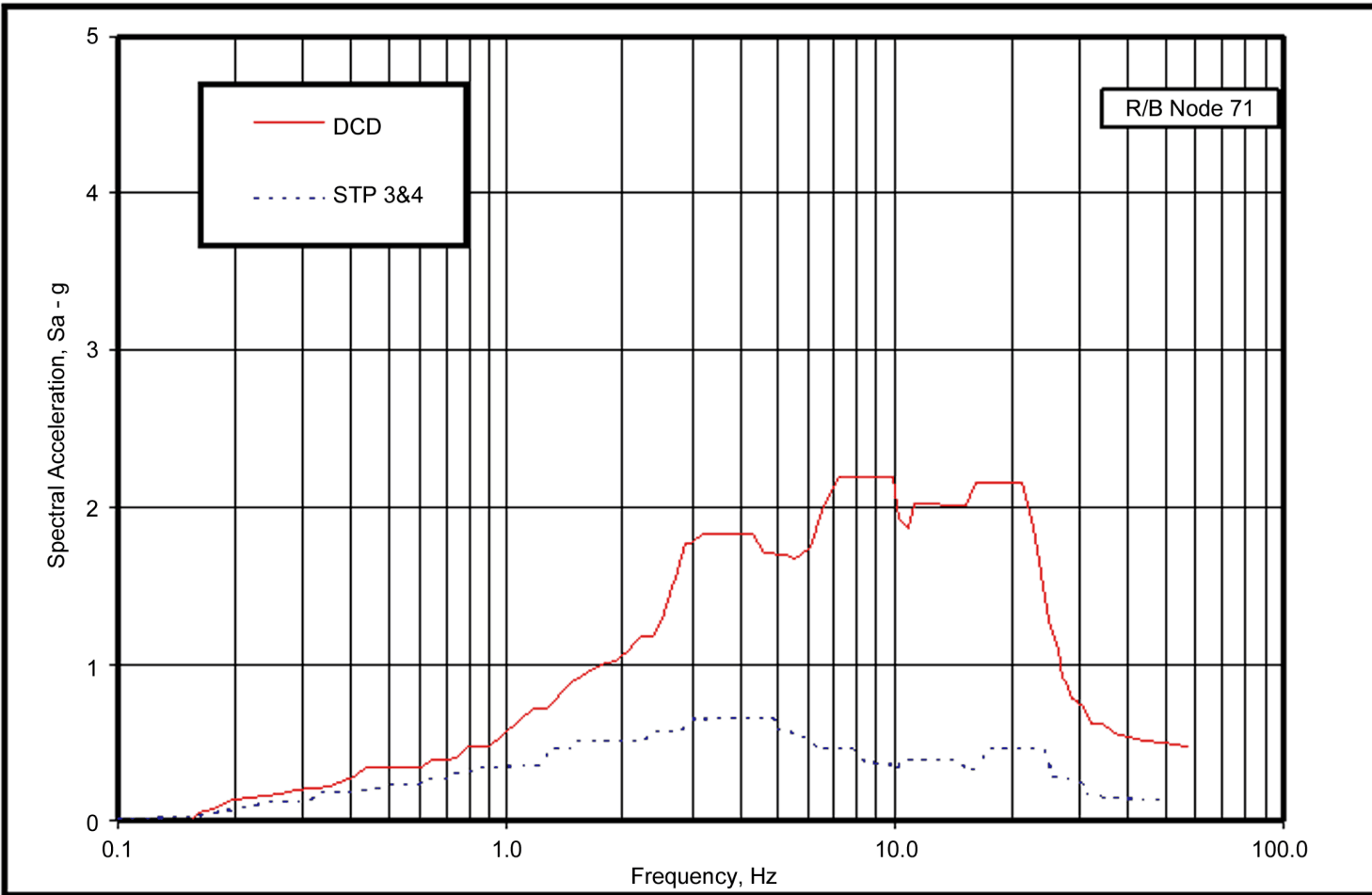

Figure 3A-284 Comparison of Reactor Building Broadened DCD and STP 3&4 Spectra Node 71 - Vertical, 2% Damping (For Node locations, see DCD Figures 3A-8 and 3A-10)

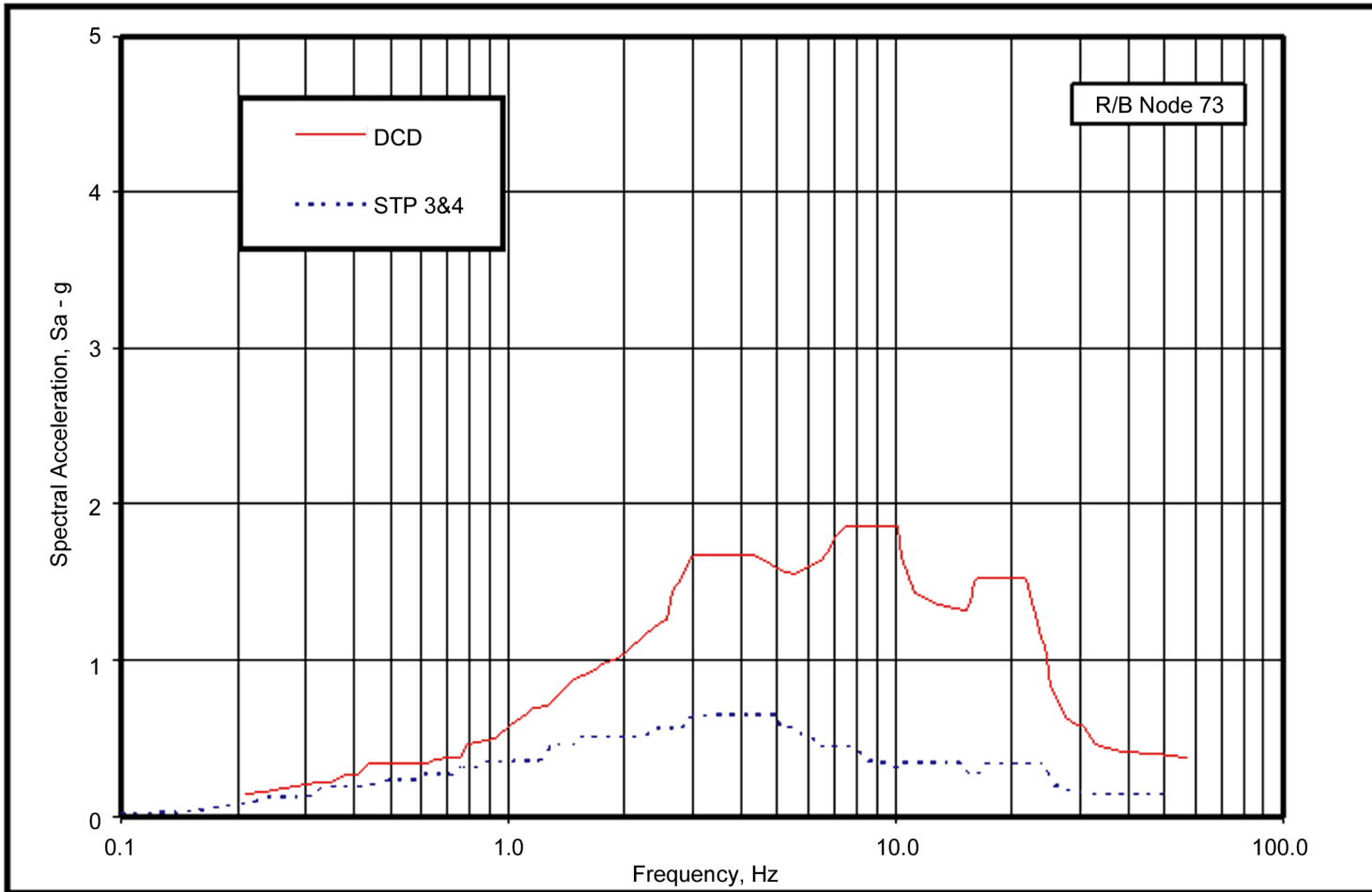

Figure 3A-285 Comparison of Reactor Building Broadened DCD and STP 3&4 Spectra Node 73 - Vertical, 2% Damping (For Node locations, see DCD Figures 3A-8 and 3A-10)

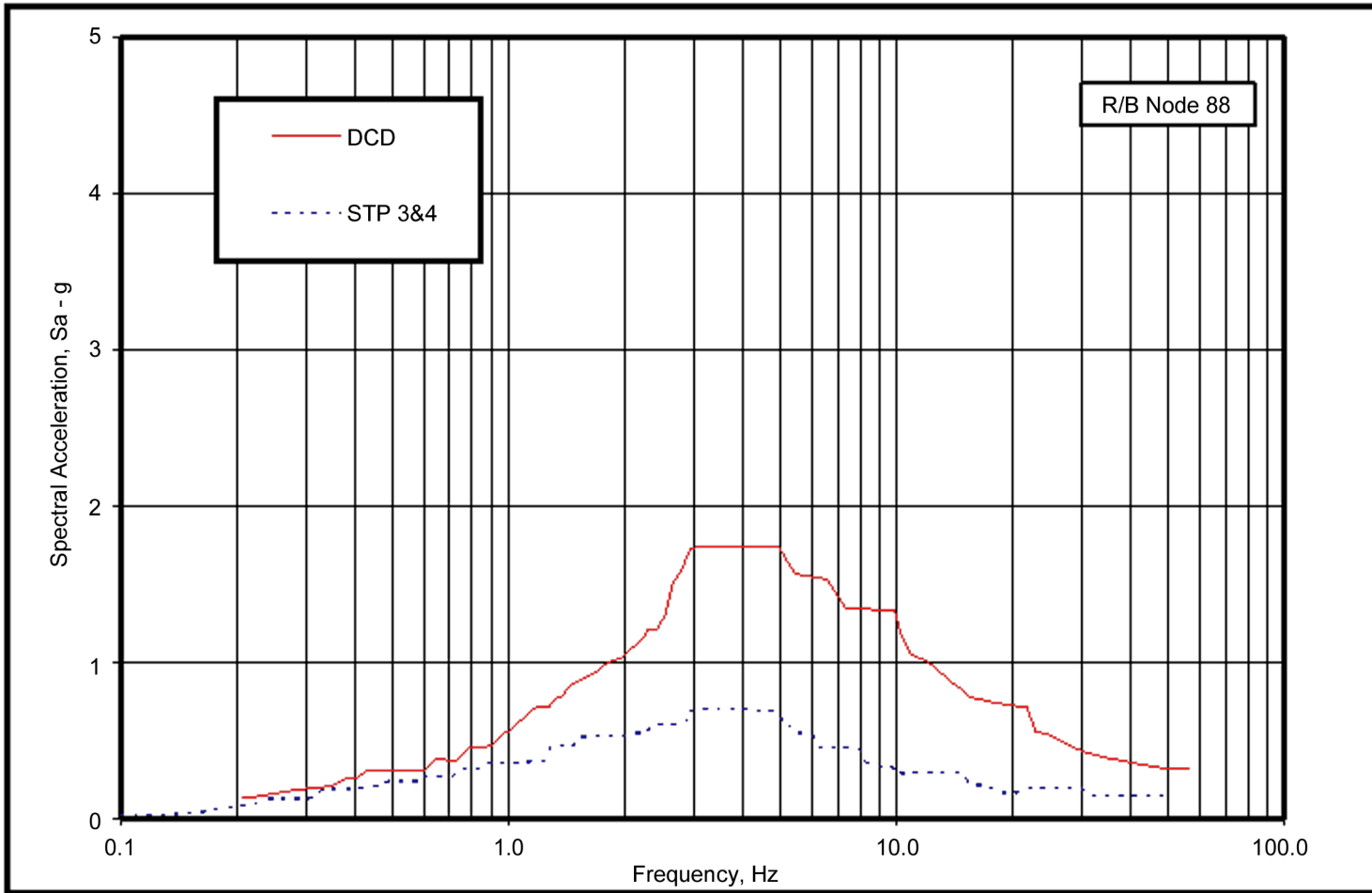

Figure 3A-286 Comparison of Reactor Building Broadened DCD and STP 3&4 Spectra Node 88 - Vertical, 2% Damping (For Node locations, see DCD Figures 3A-8 and 3A-10)

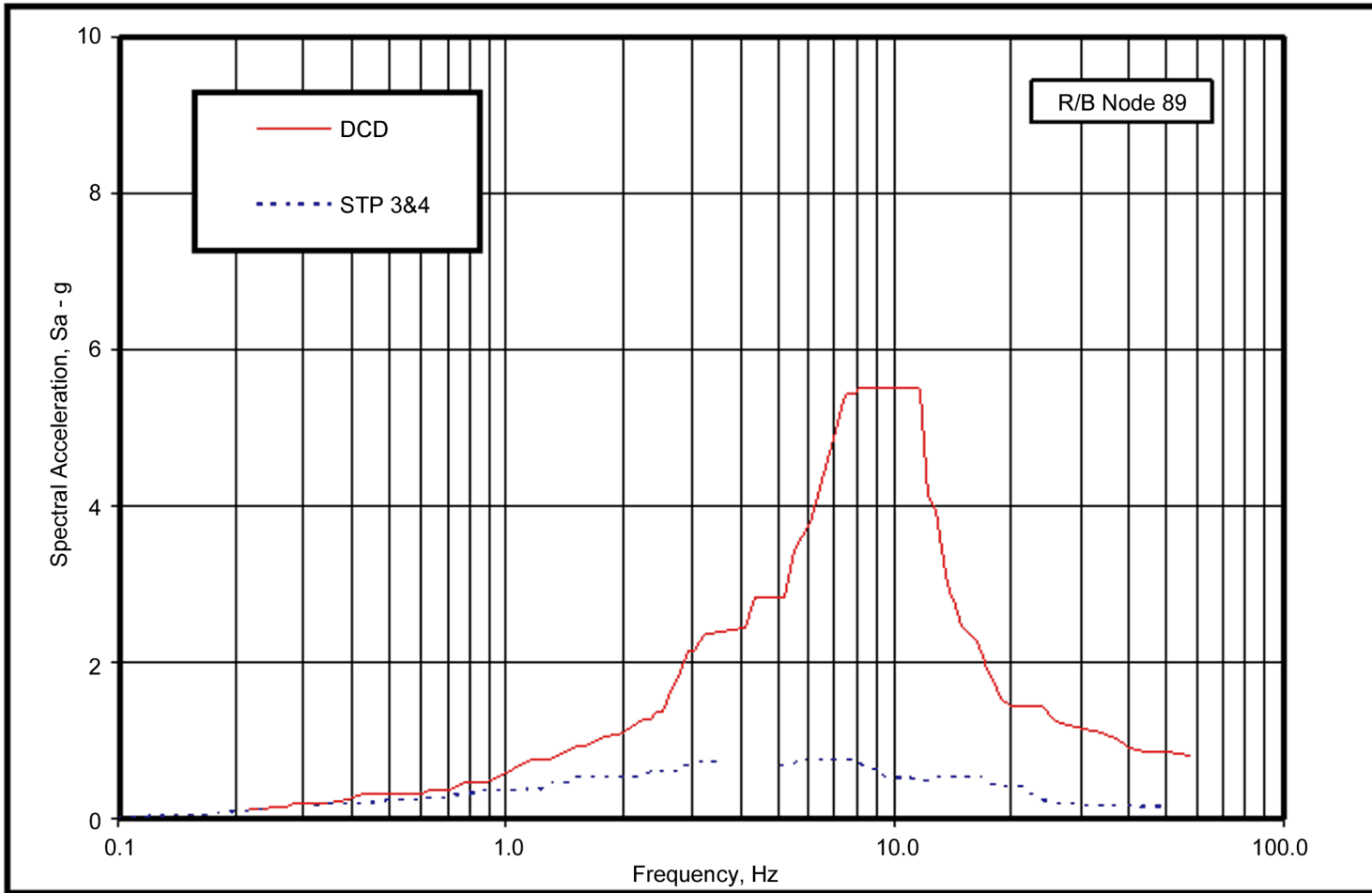

Figure 3A-287 Comparison of Reactor Building Broadened DCD and STP 3&4 Spectra Node 89 - Vertical, 2% Damping (For Node locations, see DCD Figures 3A-8 and 3A-10)

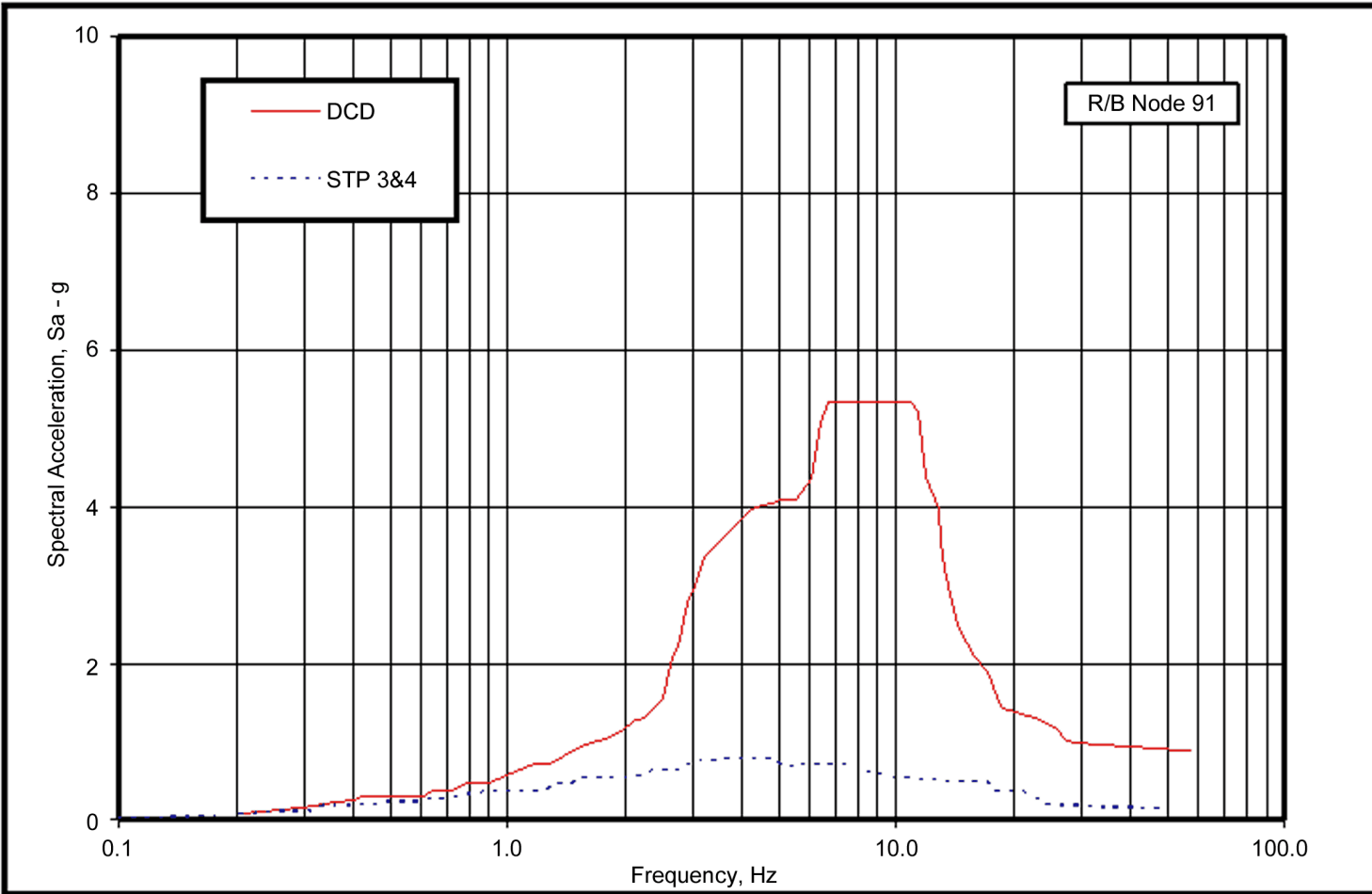

Figure 3A-288 Comparison of Reactor Building Broadened DCD and STP 3&4 Spectra Node 91 - Vertical, 2% Damping (For Node locations, see DCD Figures 3A-8 and 3A-10)

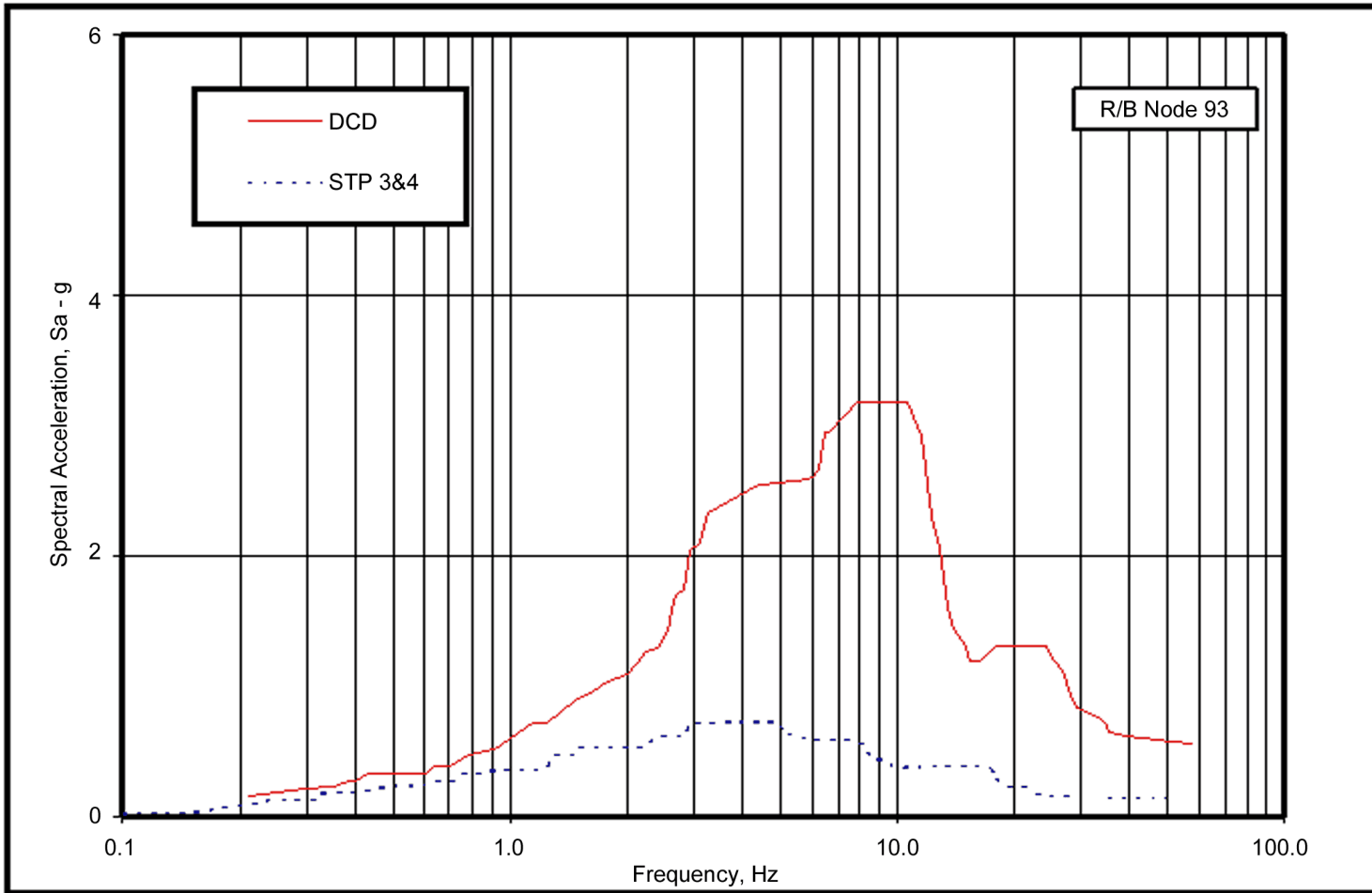

Figure 3A-289 Comparison of Reactor Building Broadened DCD and STP 3&4 Spectra Node 93 - Vertical, 2% Damping (For Node locations, see DCD Figures 3A-8 and 3A-10)

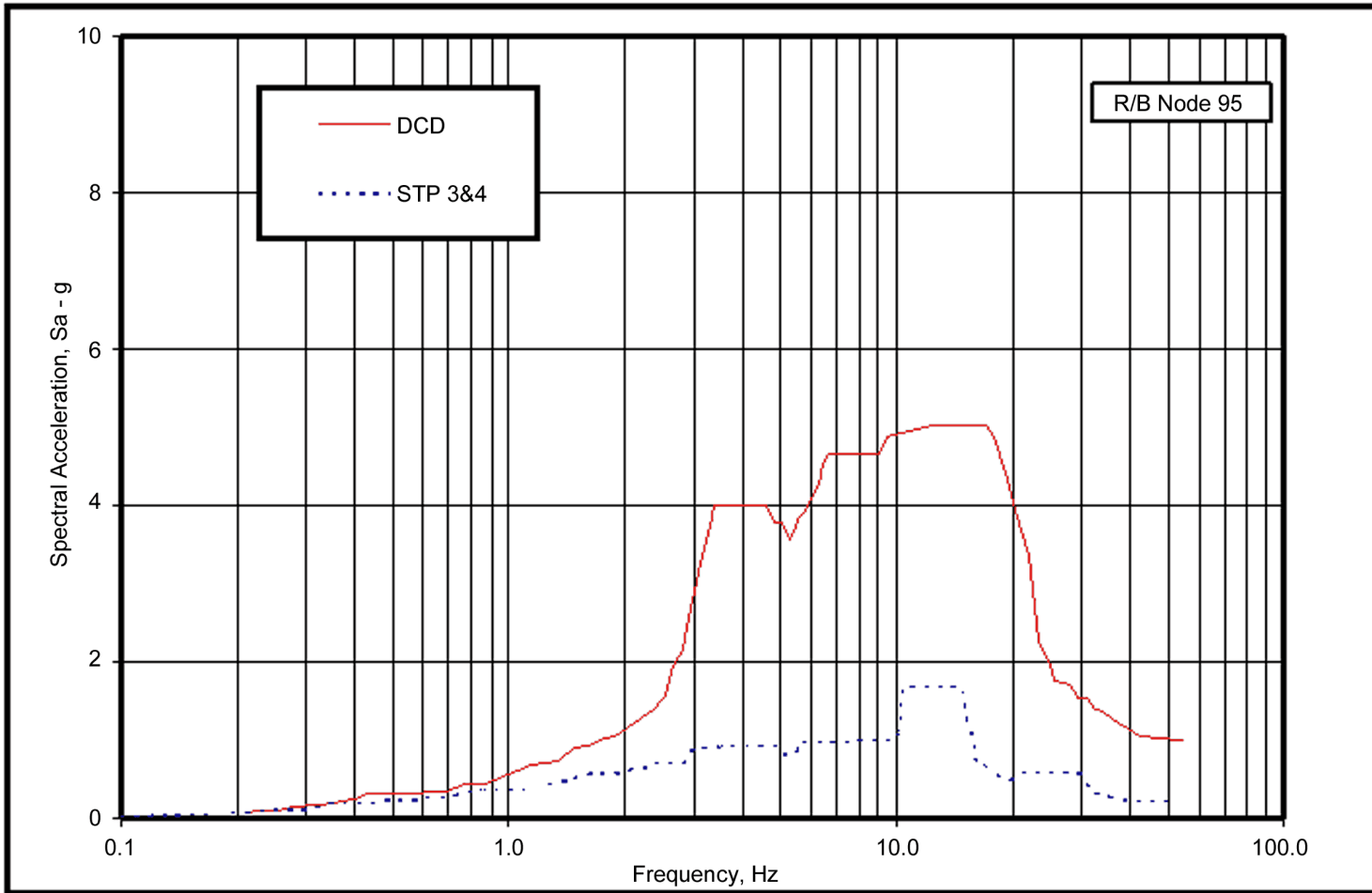

Figure 3A-290 Comparison of Reactor Building Broadened DCD and STP 3&4 Spectra Node 95 - Vertical, 2% Damping (For Node locations, see DCD Figures 3A-8 and 3A-10)



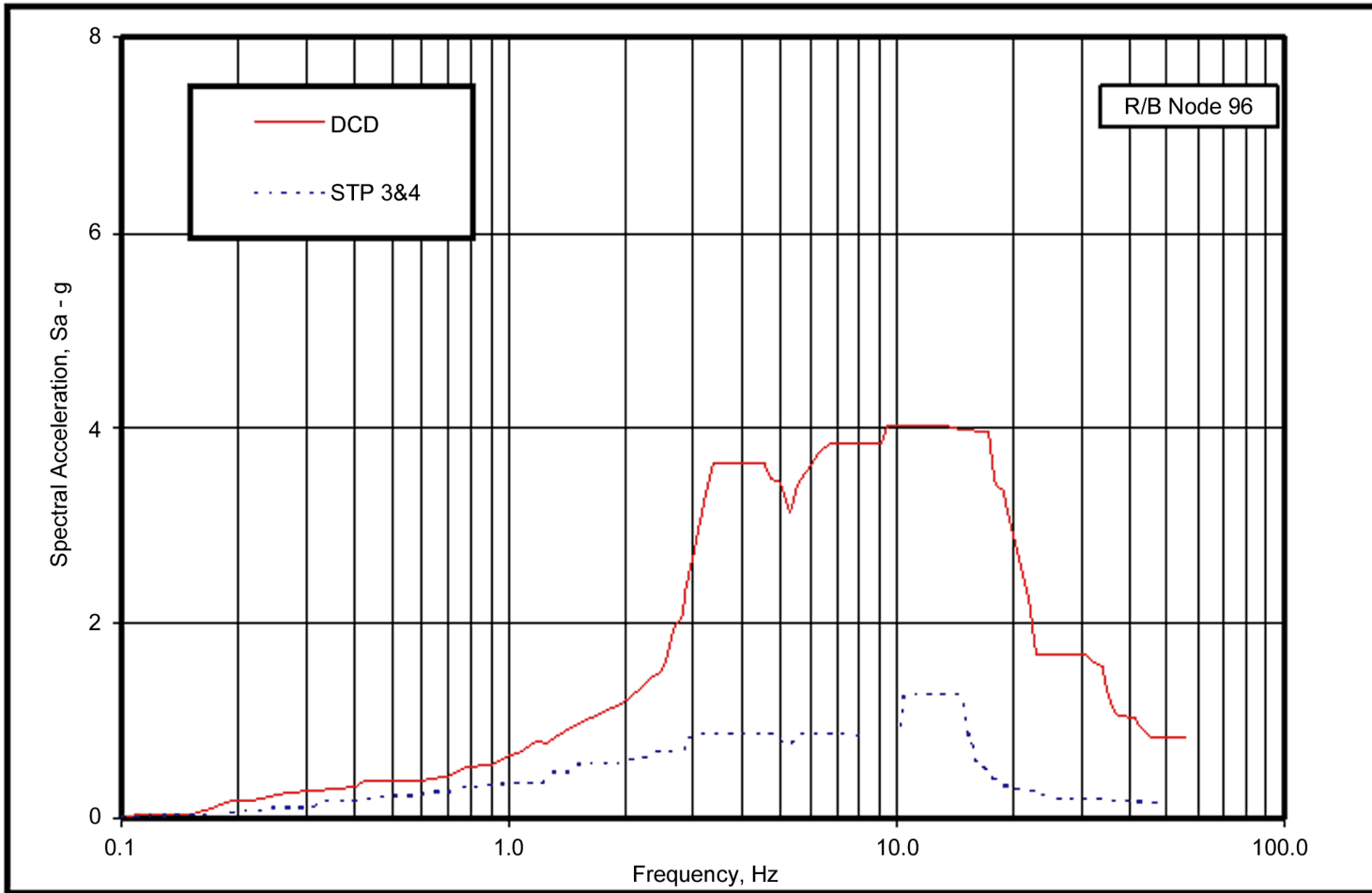

Figure 3A-291 Comparison of Reactor Building Broadened DCD and STP 3&4 Spectra Node 96 - Vertical, 2% Damping (For Node locations, see DCD Figures 3A-8 and 3A-10)

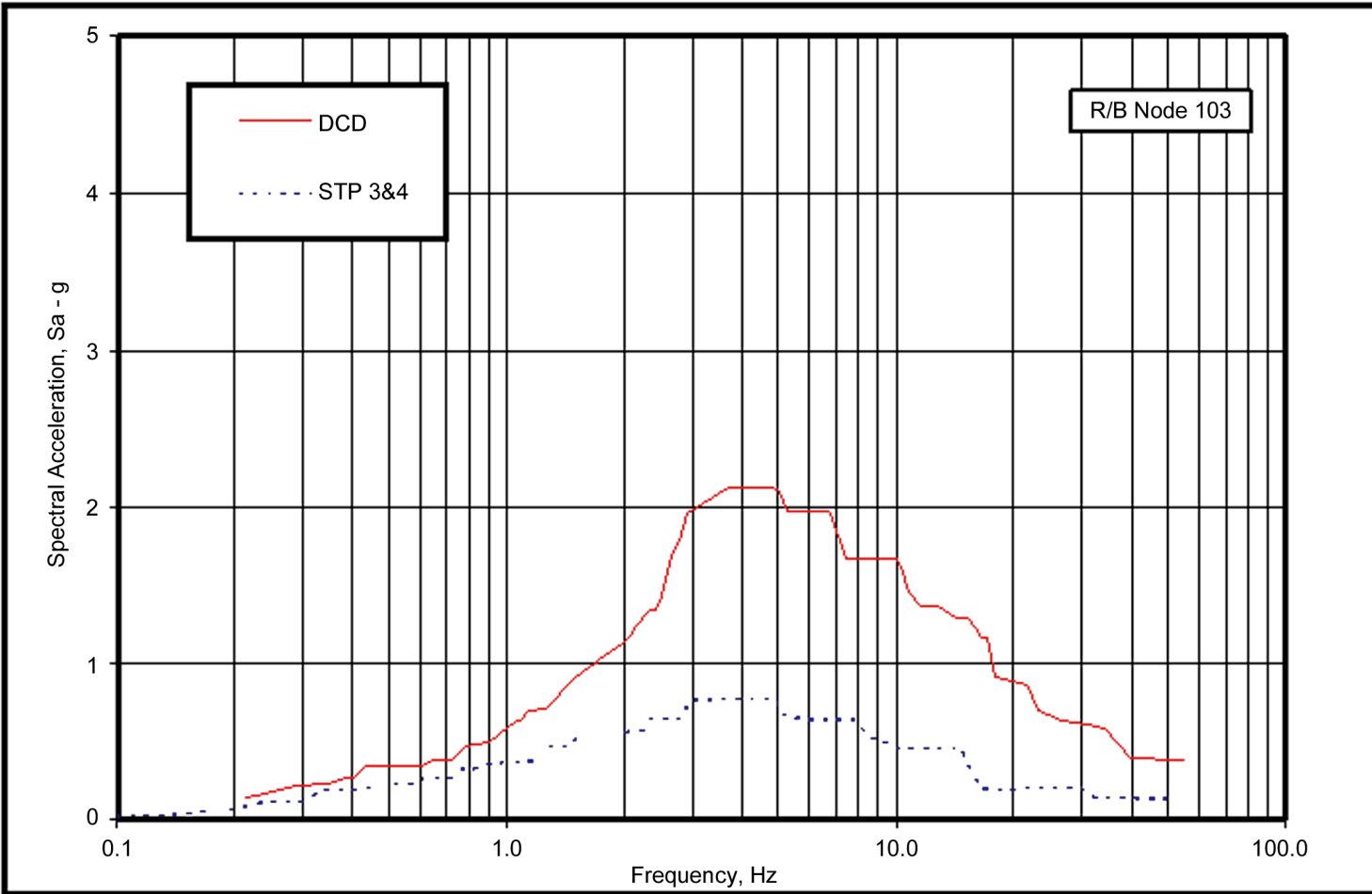

Figure 3A-292 Comparison of Reactor Building Broadened DCD and STP 3&4 Spectra Node 103 - Vertical, 2% Damping (For Node locations, see DCD Figures 3A-8 and 3A-10)

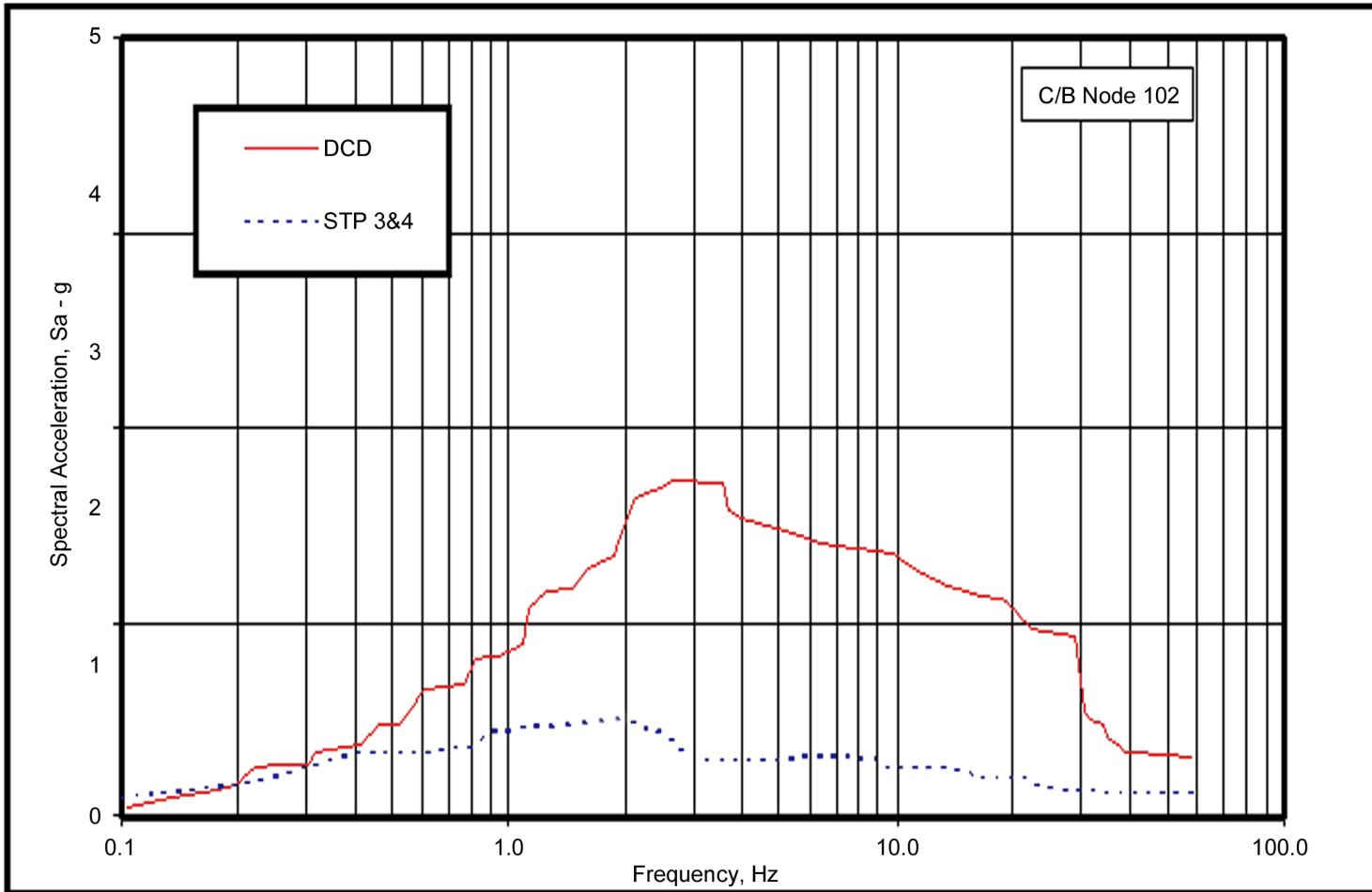
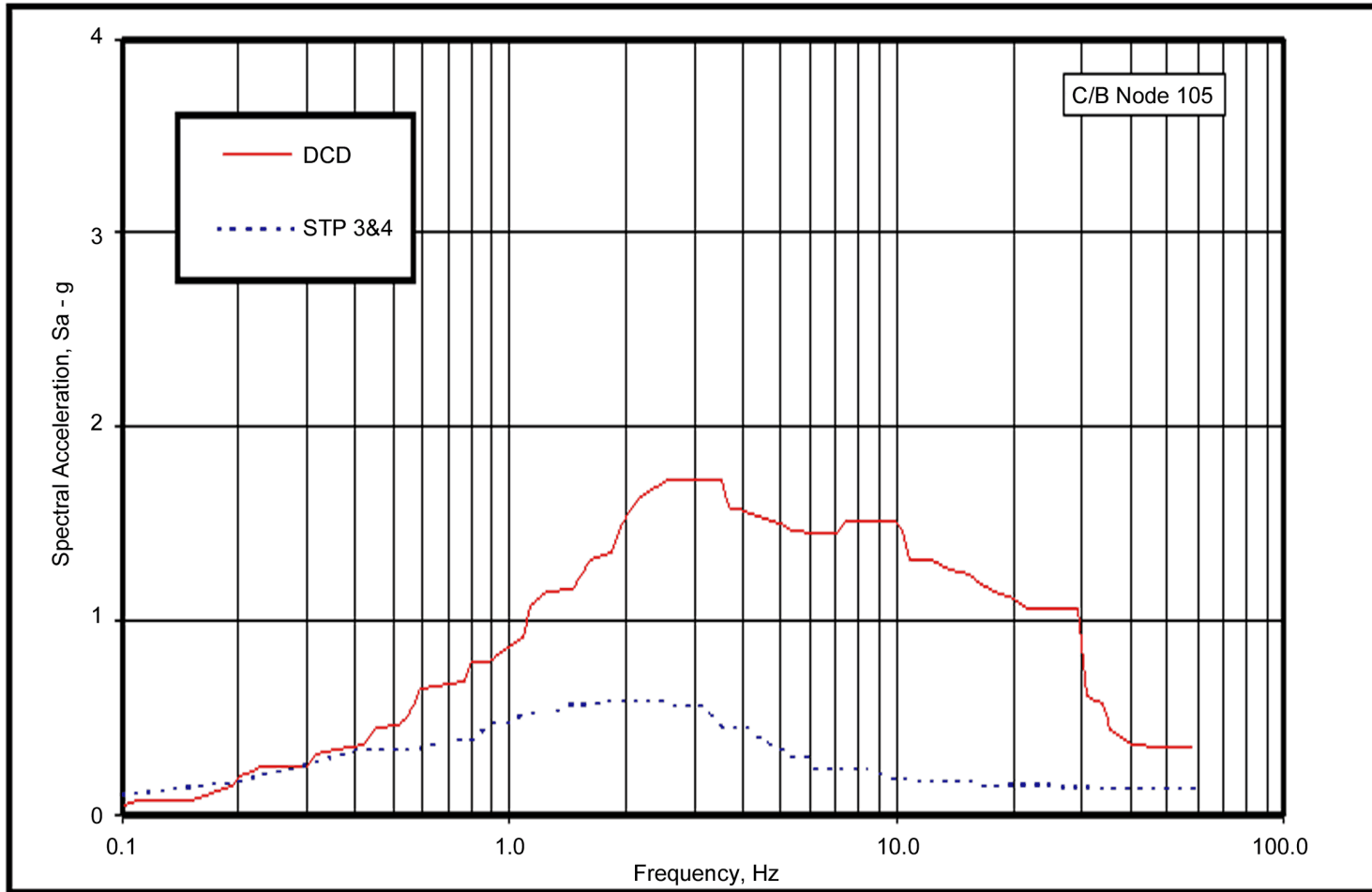

Figure 3A-293 Comparison of Control Building Broadened DCD and STP 3&4 Spectra Node 102 - Horizontal, 2% Damping (For Node locations, see DCD Figure 3A-27)



**Figure 3A-294 Comparison of Control Building Broadened DCD and STP 3&4 Spectra Node 105 - Horizontal, 2% Damping (For Node locations, see DCD Figure 3A-27)**

Note: Horizontal Spectra are the envelopes of X and Y direction spectra

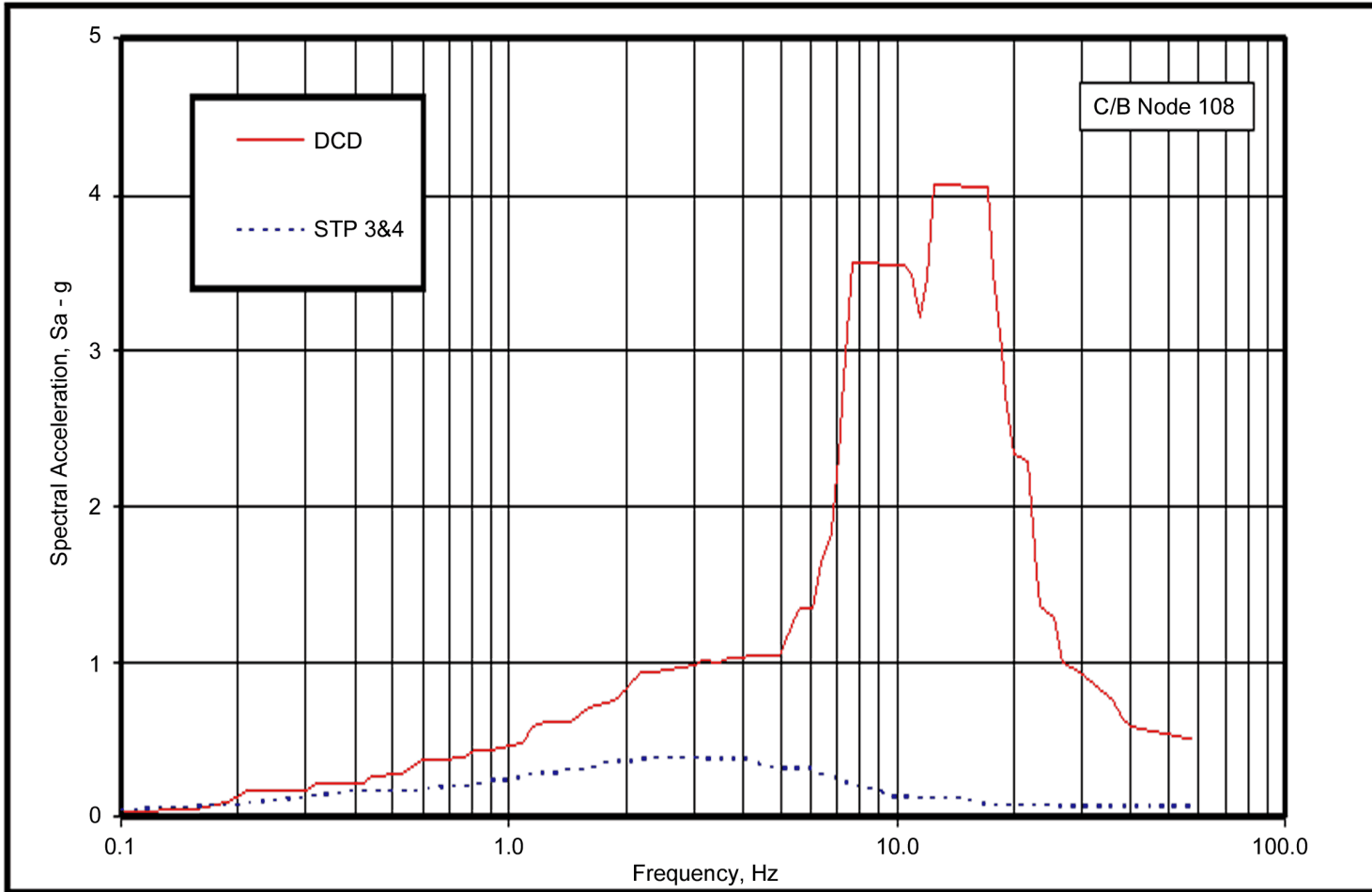

Figure 3A-295 Comparison of Control Building Broadened DCD and STP 3&4 Spectra Node 108 - Horizontal, 2% Damping (For Node locations, see DCD Figure 3A-27)

Note: Horizontal Spectra are the envelopes of X and Y direction spectra

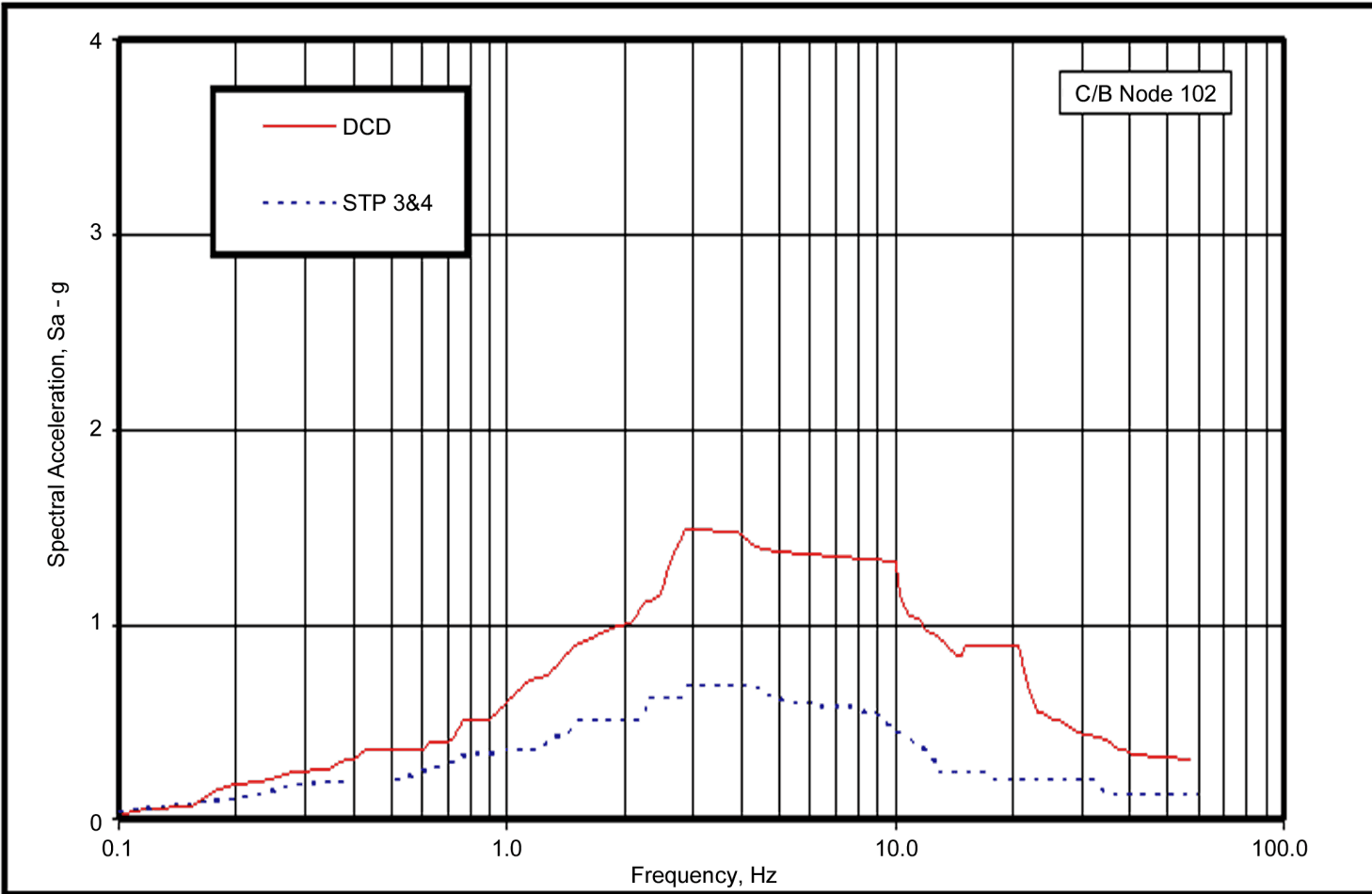

Figure 3A-296 Comparison of Control Building Broadened DCD and STP 3&4 Spectra Node 102 - Vertical, 2% Damping (For Node locations, see DCD Figure 3A-27)

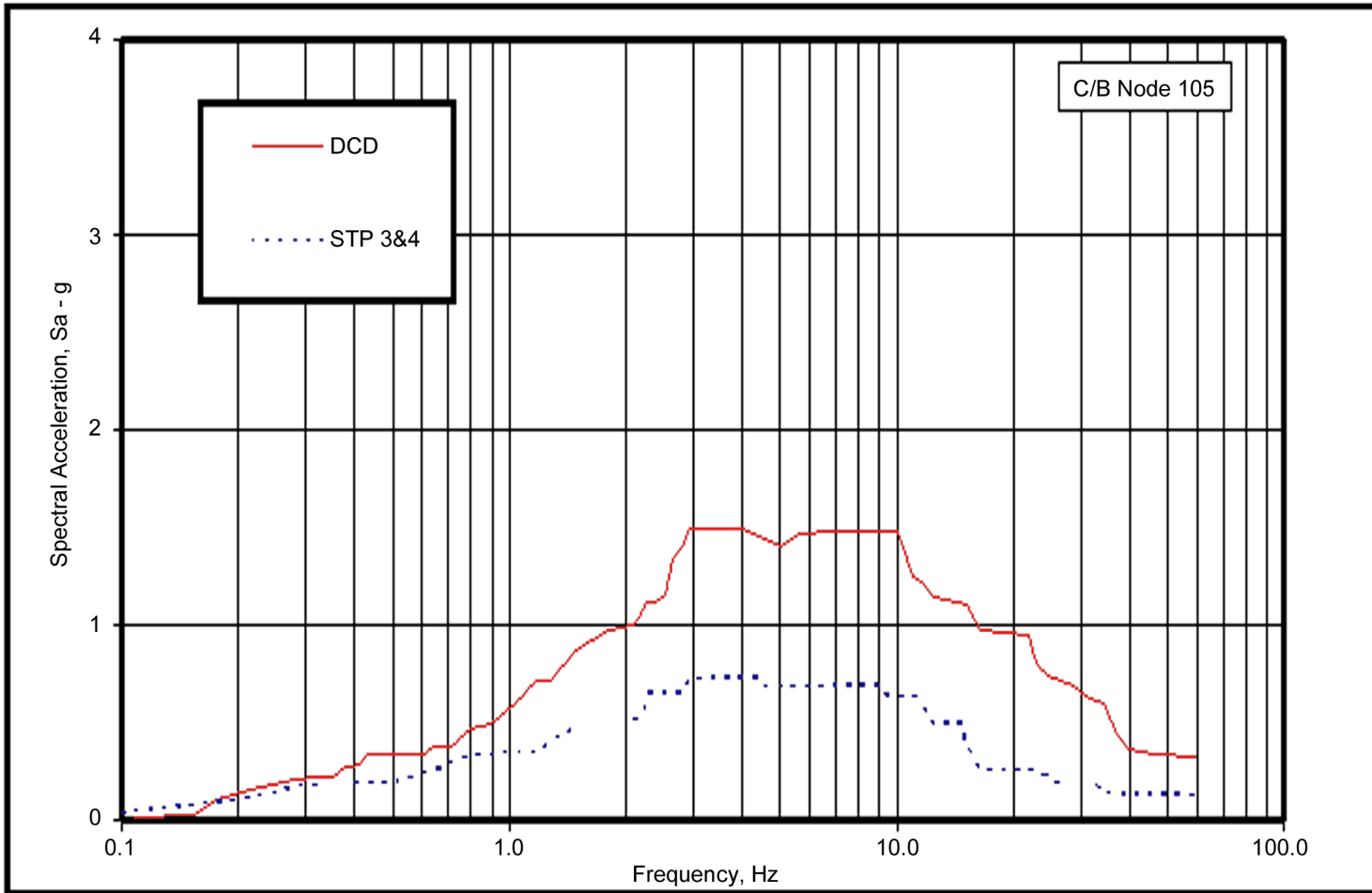

Figure 3A-297 Comparison of Control Building Broadened DCD and STP 3&4 Spectra Node 105 - Vertical, 2% Damping (For Node locations, see DCD Figure 3A-27)

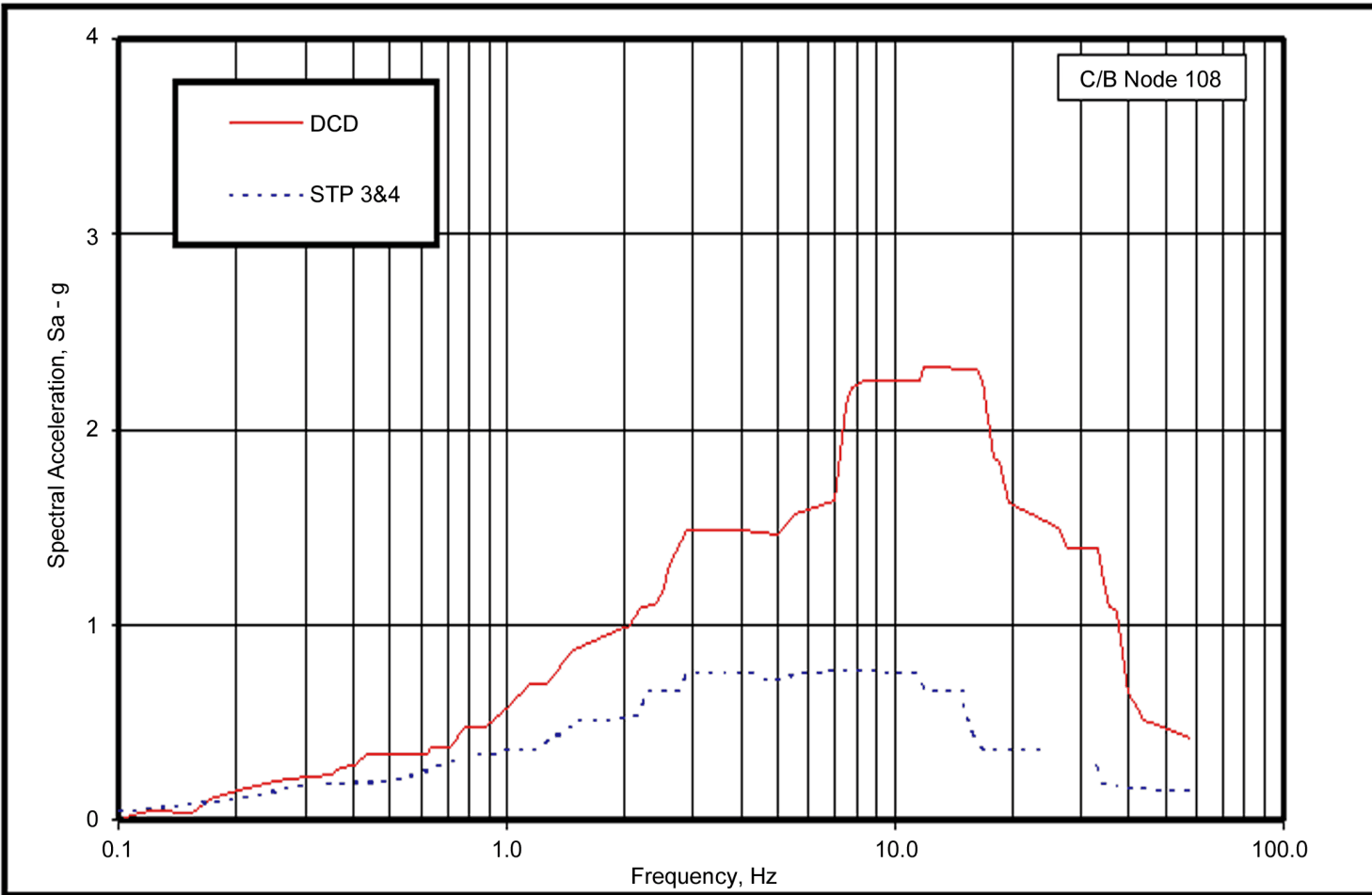

Figure 3A-298 Comparison of Control Building Broadened DCD and STP 3&4 Spectra Node 108 - Vertical, 2% Damping (For Node locations, see DCD Figure 3A-27)



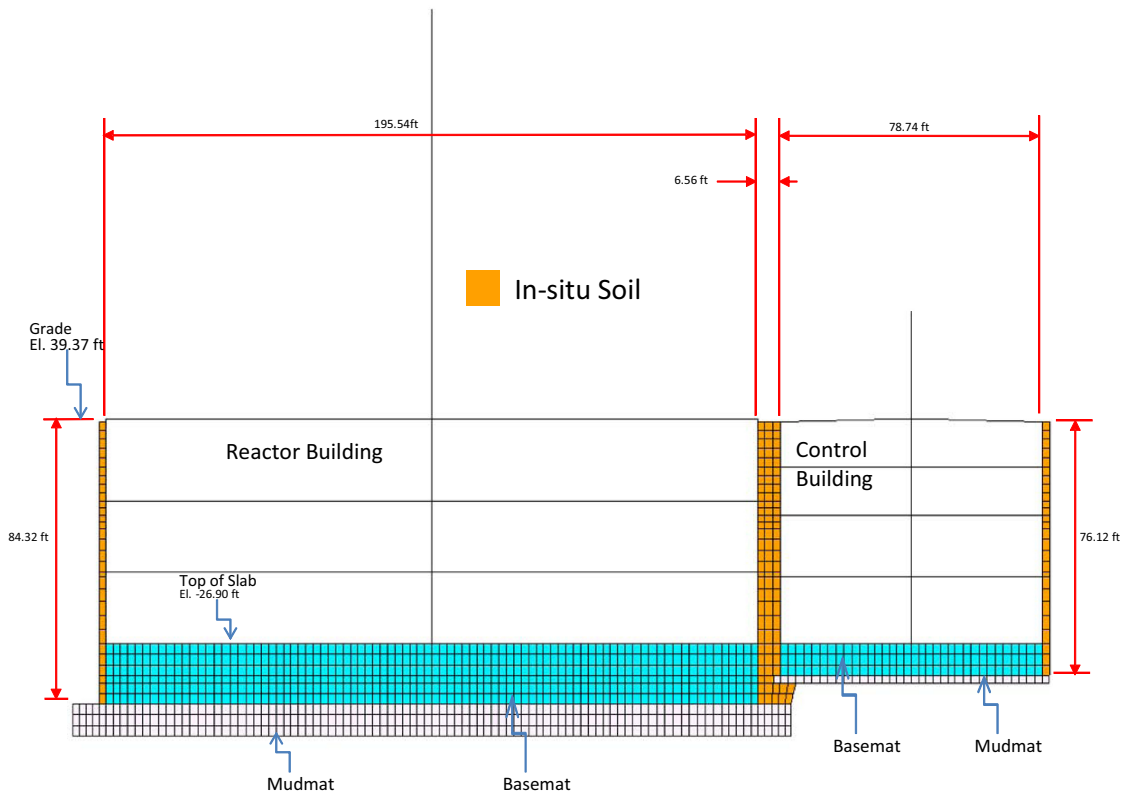

Figure 3A-299 RB+CB Model

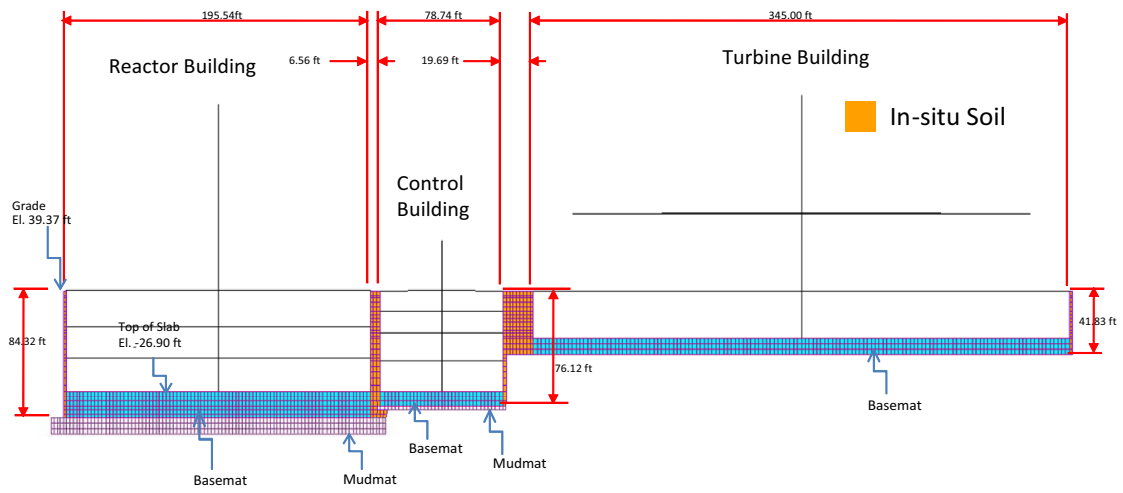

Figure 3A-300 RB+CB+TB Model

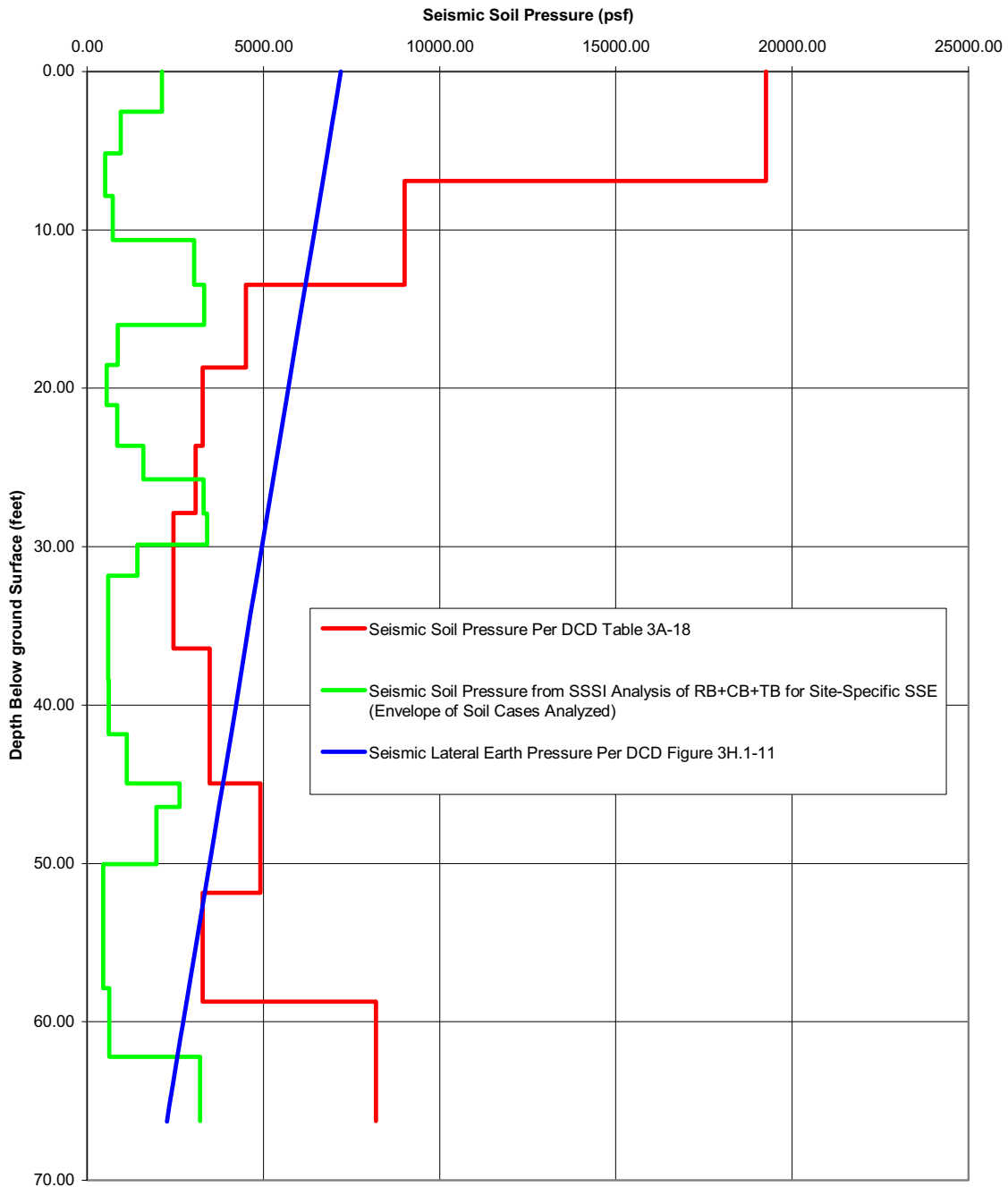

Figure 3A-301 Comparison of DCD SSE and Site-Specific SSE Seismic Soil Pressures for Reactor Building North Wall

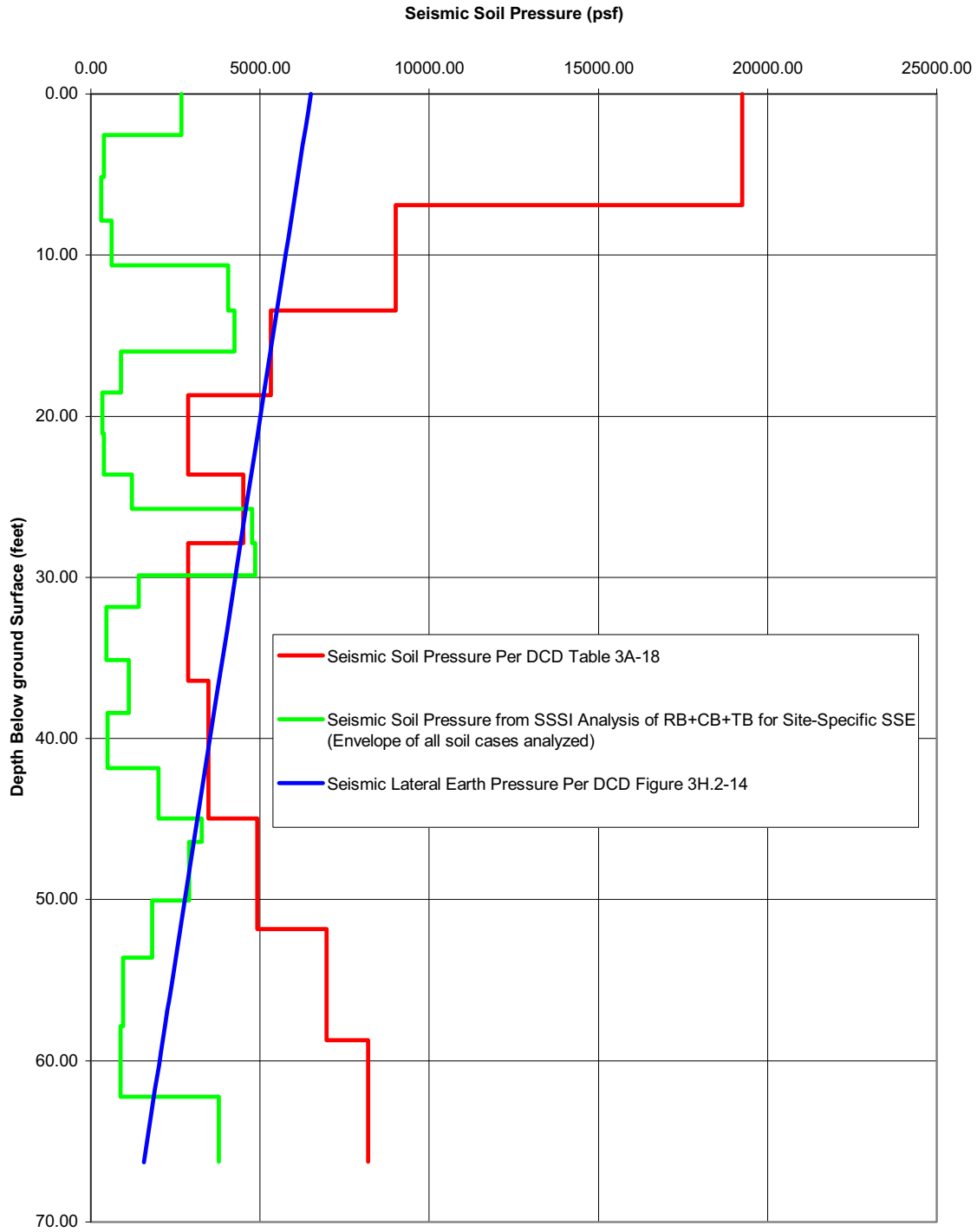

Figure 3A-302 Comparison of DCD SSE and Site-Specific SSE Seismic Soil Pressures for Control Building South Wall