

Large Break LOCA Code Applicability Report for US-APWR

Non-Proprietary Version

December 2011

**© 2011 Mitsubishi Heavy Industries, Ltd.
All Rights Reserved**

Revision History

Revision	Page	Description
0	All	Original issue
1	General ii iii v vi	<p>This report is revised to reflect the code update, the responses to RAIs and editorial changes or corrections to typo.</p> <p>Editorial corrections as follows:</p> <ul style="list-style-type: none"> • Add article "the" • Replace "type plants" to "types of plant" • Replace "Especially" to "In particular" • Replace "calculation" to "calculated" • Replace "In addition" to "In addition to this" • Replace "presented" to "presents " • Replace "includes this" to "comprises" • Divide the first sentence of the 4th paragraph into two sentences and the second one starts from "It has the same" • Eliminate article "the" • Add "Note from this point forward the term 'conventional plants' refers to a typical U.S. 4-loop PWR plant design." at the last of the 4th paragraph • Move "when compared to conventional 3- and 4- plants," from in the middle of sentence to in the first part of sentence • Replace "supported" to "supports" • Change the last sentence of page 1-1 "Also the nodding model of the US-APWR plant for the WCOBRA/TRAC(M1.0) code, which is provided in this report, is available for the LBLOCA calculation of the US-APWR as safety analysis." to "Also the nodding model of the US-APWR plant intended for the WCOBRA/TRAC(M1.0) code, provided in this report, is available for the US-APWR LBLOCA safety analysis calculation." <p>Updated Table of Contents</p> <p>Update List of Tables</p> <p>Update List of Figures</p>

<p style="text-align: center;">1 (Cont.)</p>	<p>1-1</p>	<p>Editorial corrections as follows:</p> <ul style="list-style-type: none"> • Replace “the use” to “using” in first paragraph • Replace articles “the” to “a” in first and second paragraph • Add article “the” in first paragraph • Eliminate article “the” in second paragraph • Add articles “a” in second paragraph • Replace “accumulator of the US-APWR” to “US-APWR accumulator” in second paragraph • Replace “At first” to “First” in third paragraph • Replace “appeared” to “appear” in third paragraph • Replace “results” to “corresponding results” in last paragraph • Replace “described” to “provided” in last paragraph
	<p>2-1</p>	<ul style="list-style-type: none"> • Replace “prevention” to “preventative” in section 2.0 • Replace “,” to “and” in section 2.0 • Replace “Comparisons” to “A comparisons” in subsection 2.2.1 • Replace articles “a” to “the” in subsection 2.2.3
	<p>2-2</p>	<p>Editorial corrections as follows:</p> <ul style="list-style-type: none"> • Eliminate article “the” in subsection 2.2.1 • Replace “Tinlet” to “T_{inlet}” in subsection 2.2.1
	<p>2-4</p>	<p>Editorial corrections as follows:</p> <ul style="list-style-type: none"> • Add article “the” in subsection 2.3.4 • Eliminate article “the” in subsection 2.3.5 <p>Technical correction</p> <ul style="list-style-type: none"> • Correct the description of Pressurizer from “The relief lines discharge through spargers in the refueling water storage pit (RWSP) inside the containment.” to “The relief lines discharge steam and water into the pressurizer relief tank inside the containment.” in subsection 2.3.5
	<p>2-5</p>	<p>Editorial corrections as follows:</p> <ul style="list-style-type: none"> • Replace “:” to “;” in subsection 2.4.2 • Replace “orderly” to “systematically” in subsection 2.4.2 <p>RAI Response</p> <ul style="list-style-type: none"> • Reflect the response to RAI (Request 2.2) into the description of the ECCS functions.
	<p>2-6</p>	<p>Editorial corrections as follows:</p> <ul style="list-style-type: none"> • Eliminate “function to” in subsection 2.4.2.1 • Replace “in” to “during” in subsection 2.4.2.1
	<p>2-7</p>	<p>Editorial corrections as follows:</p> <ul style="list-style-type: none"> • Replace “eliminate” to “eliminates” in subsection 2.4.2.1 • Replace “on” to “in” in subsection 2.4.2.2 • Eliminate article “the” in subsection 2.4.2.2 <p>RAI Response</p> <ul style="list-style-type: none"> • Reflect the response to RAI (Request 2.1) and add the subsection 2.4.2.3 to describe “Emergency Letdown System”
	<p>2-8</p>	<p>Editorial correction as follows:</p> <ul style="list-style-type: none"> • Replace “in” to “at” in subsection 2.4.3

<p>1 (Cont.)</p>	<p>2-10</p>	<p>Editorial corrections as follows:</p> <ul style="list-style-type: none"> • Assign numbers to the comments below the Table • Replace “Vogtle Unit #1 are referred to as a US current 4-loop PWR” to “Vogtle Unit #1 is used as the U.S. current 4-loop PWR design” • Replace “those of” to “specific to” • Add article “a” • Replace “are in” to “were retrieved from”
	<p>2-12 through 2-24</p>	<p>Editorial (resolution enhancement)</p> <ul style="list-style-type: none"> • Replace the figure in Table2-3 and Figures 2-1 through 2-12
	<p>3-1</p>	<p>Editorial corrections as follows:</p> <ul style="list-style-type: none"> • Replace “approves” to “approved ” in section 3.1 • Eliminate article “the” in section 3.1 • Replace “analysis” to “analyses ” in section 3.1 • Replace “APWR though some minor modifications should be performed” to “, taking into account some minor modifications ” in section 3.1 • Replace “supported” to “supports ” in section 3.1 • Replace “have” to “has ” in section 3.1 • Replace article “a” to “the” in section 3.2
	<p>3-2</p>	<p>Editorial corrections as follows:</p> <ul style="list-style-type: none"> • Replace “termed” to “identified as ” in section 3.3.1 • Replace article “a” to “the” in subsection 3.3.2
	<p>3-3</p>	<p>Editorial corrections as follows:</p> <ul style="list-style-type: none"> • Eliminate article “the” in subsection 3.3.2 • Add article “the” in subsection 3.3.2 • Replace “degrading” to “degraded” in section 3.3.2 • Replace “turns on” to “actuates” in subsection 3.3.3 • Replace “of DVI design” to “via the DVI nozzles” in subsection 3.3.3 • Add article “a” in subsection 3.3.3 • Replace “at the time” to “when” in subsection 3.3.4 • Replace “make” to “maintain” in subsection 3.3.4 • Add article “the” in subsection 3.3.4
	<p>3-4</p>	<p>Editorial corrections as follows:</p> <ul style="list-style-type: none"> • Replace “near to” to “nearly” in subsection 3.3.4 • Add articles “the” in subsection 3.3.4
	<p>3-8</p>	<p>Editorial corrections as follows:</p> <ul style="list-style-type: none"> • Replace “with the condition that” to “when” in subsection 3.4.1 • Replace “digital” to “numerical” in subsection 3.4.1
	<p>3-9</p>	<p>Editorial corrections as follows:</p> <ul style="list-style-type: none"> • Replace “the heat-up” to “the heat-up rate” in subsection 3.4.1.1 • Replace “usual analysis” to “standard analyses” in subsection 3.4.1.1 • Replace “degraded” to “degrades” in subsection 3.4.1.1 • Replace “is considered” to “discusses in” in subsection 3.4.1.1

1 (Cont.)	3-10	<p>Editorial corrections as follows:</p> <ul style="list-style-type: none"> • Replace “linear heat rate” to “linear heat generation rate ” in subsection 3.4.1.2 • Replace “in a bigger” to “within a larger” in subsection 3.4.1.2 • Replace “on” to “of” in subsection 3.4.1.2
	3-11	<p>Editorial corrections as follows:</p> <ul style="list-style-type: none"> • Replace “The entrainment” to “Entrainment” in subsection 3.4.1.2 • Replace “comes” to “goes” in subsection 3.4.1.3 • Replace “almost” to “nearly” in subsection 3.4.1.4
	3-12	<p>Editorial corrections as follows:</p> <ul style="list-style-type: none"> • Replace “almost” to “nearly” in subsection 3.4.1.5 • Eliminate “to” in subsection 3.4.1.6 • Replace “especially” to “particularly” in subsection 3.4.1.6 • Replace “through” to “throughout” in subsection 3.4.1.7 • Add article “the” in subsection 3.4.1.7
	3-13	<p>Editorial correction as follows:</p> <ul style="list-style-type: none"> • Add “traveling” in last sentence of third paragraph of subsection 3.4.1.9
	3-14	<p>Editorial corrections as follows:</p> <ul style="list-style-type: none"> • Replace “almost” to “nearly” in subsection 3.4.1.10 • Replace “give up their” to “release” in subsection 3.4.1.10 • Add article “the” in subsection 3.4.1.10
	3-18	<p>Technical Correction</p> <ul style="list-style-type: none"> • Correct the ranking indicator for “Cold leg /Accumulator Non-condensable-gas during Reflooding period” in Table 3.4-1, to adjust the explanation in subsection 3.4.1.8.
	3-21	<p>Editorial corrections as follows:</p> <ul style="list-style-type: none"> • Add article “the” in subsection 3.5.1.1 • Replace article “a” to “the” in subsection 3.5.1.1 • Add “and” in subsection 3.5.1.1
	3-22	<p>Editorial corrections as follows:</p> <ul style="list-style-type: none"> • Replace “model of the code concerning flow resistance” to “flow resistance model of the code” in subsection 3.5.1.1 • Add article “the” in subsection 3.5.1.1 • Eliminate “as” in subsection 3.5.1.2
	3-23	<p>Editorial correction as follows:</p> <ul style="list-style-type: none"> • Replace “include” to “includes” in subsection 3.5.1.3
	3-24	<p>Editorial correction as follows:</p> <ul style="list-style-type: none"> • Replace “based on user’s manual (Ref.10)” to “in the same method as plant analysis” in subsection 3.5.1.3 (4)

<p>1 (Cont.)</p>	<p>3-25</p>	<p>Editorial corrections as follows:</p> <ul style="list-style-type: none"> • Replace “its treatment” to “how it is treated” in subsection 3.5.1.4 • Replace “were” to “was” in subsection 3.5.1.4(1) • Replace “for the safety analysis for a LBLOCA.” to “for the LOCA safety analysis.” in subsection 3.5.1.4(1) • Re-number “Ref.11” to “Ref.10” in subsection 3.5.1.4(1) <p>Technical Change</p> <ul style="list-style-type: none"> • Add the description of scaling effect for the Advanced Accumulator in subsection 3.5.1.4(1)
	<p>3-27</p>	<p>Technical Change</p> <ul style="list-style-type: none"> • Correct the equation 3.5.1-7, and description corresponding to it. • Add the description how the uncertainty of dispersion deviation is treated in the statistical analysis
	<p>3-28</p>	<p>Editorial corrections as follows:</p> <ul style="list-style-type: none"> • Add article “the” • Replace table number “Table 3.5-5” to “Table 3.5-4” • Add “shown in Table 3.5 5”
	<p>3-28</p>	<p>Editorial correction as follows:</p> <ul style="list-style-type: none"> • Replace table number “Table 3.5-5” to “Table 3.5-6” <p>Technical Change</p> <ul style="list-style-type: none"> • Add the description of uncertainty range sampled in the analysis • Add the description of scaling effect for the Advanced Accumulator and how it is treated in the analysis
	<p>3-29</p>	<p>Editorial corrections as follows:</p> <ul style="list-style-type: none"> • Update the table number from “Table 3.5-7” to “Table 3.5-8” • Replace “revised” to “modified” • Eliminate “as” • Replace “was” to “has been” • Replace “On the other hand” to “In addition”
	<p>3-34</p>	<p>Technical Change</p> <ul style="list-style-type: none"> • Update Table3.5-6 • Add Table3.5-7
	<p>3-41 through 3-45</p>	<p>Technical Change</p> <ul style="list-style-type: none"> • Replace figures 3.5-7 through 3.5-9 re-analyzed in accordance with the code update
	<p>3-47</p>	<p>Editorial corrections as follows:</p> <ul style="list-style-type: none"> • Replace “can not” to “cannot” in subsection 3.5.3.1(5) • Replace “are rising” to “rise” in subsection 3.5.3.1(6) • Add articles “the” in subsection 3.5.3.1(6) • Replace “Thus” to “Consequently” in subsection 3.5.3.1 • Add article “the” in subsection 3.5.3.1 • Replace “model of entrainment and de-entrainment” to “entrainment and de-entrainment modeling” in subsection 3.5.3.2
	<p>3-48</p>	<p>Editorial correction as follows:</p> <ul style="list-style-type: none"> • Replace “Ref.12” to “Ref.11” in subsection 3.5.3.3 c)

<p>1 (Cont.)</p>	3-50	<p>Editorial (resolution enhancement)</p> <ul style="list-style-type: none"> • Replace Figures 3.5-10
	3-54	<p>Technical Change</p> <ul style="list-style-type: none"> •
	3-55	<p>Editorial correction as follows:</p> <ul style="list-style-type: none"> • Replace “as” to “to be” in subsection 3.6.11 <p>Editorial corrections as follows:</p> <ul style="list-style-type: none"> • Replace “is” to “was” in subsection 3.6.11 • Replace “the guide tube from the viewpoint of the reflooding PCT” to “an open hole” to to correspond with the sample plant analysis
	3-57	<p>Editorial correction as follows:</p> <ul style="list-style-type: none"> • Replace “Ref.13” to “Ref.12” in subsection 3.6.1.2
	3-58	<p>Editorial corrections as follows:</p> <ul style="list-style-type: none"> • Add articles “the” in subsection 3.6.1.3 • Replace “Ref.14,15,16” to “Ref.13,14,15” in subsection 3.6.2.2
	3-59	<p>Editorial correction as follows:</p> <ul style="list-style-type: none"> • Replace “Ref.17” to “Ref.16” in subsection 3.6.3.2
	3-60	<p>Editorial corrections as follows:</p> <ul style="list-style-type: none"> • Replace “Ref.18” to “Ref.17” in subsection 3.6.3.2 • Replace “Ref.17” to “Ref.16” in subsection 3.6.3.2 • Replace “Ref.19” to “Ref.18” in subsection 3.6.3.2
	3-61	<p>RAI Response</p> <ul style="list-style-type: none"> • Reflect the response to RAI (Request 3.15.2) into subsection 3.6.5.2
	3-63 and 3-65	<p>Technical Change</p> <ul style="list-style-type: none"> • Update the Tables 3.6-1, 3.6-2 and bottom note corresponding to the sample plant analysis
	3-69	<p>Technical Change</p> <ul style="list-style-type: none"> • Update the Table 3.6-5 corresponding to the sample plant analysis
	3-70	<p>Technical Change</p> <ul style="list-style-type: none"> • Update the Table 3.6-6 corresponding to re-analysis result
	3-71	<p>Editorial Change</p> <ul style="list-style-type: none"> • Update Figure 3-6.1

<p>1 (Cont.)</p>	3-72 and 3-78	<p>Technical Change</p> <ul style="list-style-type: none"> • Update Figures 3.6-2 and 3.6-8 corresponding to the sample plant analysis
	3-83 through 3-89	<p>Technical Change</p> <ul style="list-style-type: none"> • Update the Figures 3.6-13 through 3.6-18 corresponding to re-analysis result
	3-90	<p>Editorial corrections as follows:</p> <ul style="list-style-type: none"> • Replace “Ref.20” to “Ref.19” • Replace “Ref.21” to “Ref.20”
	3-92	<p>Editorial corrections as follows:</p> <ul style="list-style-type: none"> • Add “in” in the last sentence of the second paragraph • Replace “almosts all” to “most of” • Re-arrange the description of subsection 3.7.2 • Replace “For most of the parameters, the nominal value was assumed for the sample calculation.” to “For most of the parameters used in the sample plant analysis, the nominal value was assumed.” • Replace “take accounted for in” to “taken into account for ”
		<p>Technical Change</p> <ul style="list-style-type: none"> • Replace “Table 3.7 1 and Table 3.7 2” to “Table 3.7 1 through Table 3.7 3” to reflect RAI response (Request 3.16.3) • Change the model related description in last paragraph of subsection 3.7.2 to reflect RAI response (Request 3.16.3)
	3-95	<p>Technical Correction</p> <ul style="list-style-type: none"> • •
	3-95 and 96	<p>Technical Change</p> <ul style="list-style-type: none"> • Update and correct Table 3.7-1
	3-98	<p>Technical Change</p> <ul style="list-style-type: none"> • Add Table 3.7-3 to reflect RAI response (Request 3.16.3)
	4-1	<p>Editorial corrections as follows:</p> <ul style="list-style-type: none"> • Reflect RAI response (Request 3.16.3) into the first paragraph • Replace “In conclusion, the WCOBRA/TRAC(M1.0) code and the ASTRUM methodology are available to provide the analysis results in the Design Control Documents (DCD) of the US-APWR plant. Also, the nodding model of the WCOBRA/TRAC(M1.0) code for the US-APWR plant is available for LBLOCA calculation of the US-APWR as a safety analysis.” to “In conclusion, the WCOBRA/TRAC(M1.0) code and the ASTRUM methodology are acceptable to provide analysis results for the US-APWR Design Control Documents (DCD). In addition, the nodding model of the WCOBRA/TRAC(M1.0) code for the US-APWR plant is acceptable for the LOCA safety analysis calculation.”
5-1	<p>Update the listing of references</p>	

<p>1 (Cont.)</p>	<p>A-1</p> <p>A-2</p> <p>B-1</p> <p>B-3</p> <p>B-6</p>	<p>Editorial corrections as follows:</p> <ul style="list-style-type: none"> • Replace “if it is taken into consideration of” to “when taking into account” • Replace “in which” to “that has” • Replace “degrading” to “degradation” • Replace “partly” to “partially” • Replace “uncertainty of stored energy” to “stored energy uncertainty” • Replace “can apply fuel of the US-APWR fuel.” to “can be applied to the US-APWR fuel.” <p>Update the revision of reference A-2</p> <p>Editorial corrections as follows:</p> <ul style="list-style-type: none"> • • <p>Technical Change</p> <ul style="list-style-type: none"> • Add the description how the scaling uncertainty is treated in the code <p>Editorial correction as follows:</p> <ul style="list-style-type: none"> • <p>Add reference B-3 for scaling uncertainty</p>
<p>2</p>	<p>2-2 and 2-11</p> <p>3-26</p> <p>3-28</p> <p>3-29</p>	<p>RAI Response</p> <ul style="list-style-type: none"> • Reflect the response to Question-2, which was provided with UAP-HF-11128, into Subsection 2.2.3 and Table 2-2 <p>Technical Change</p> <ul style="list-style-type: none"> • <p>Editorial corrections as follows:</p> <ul style="list-style-type: none"> • Replace “shows in Table 3.5-7” to “shown in Table 3.5-7” • <p>Editorial correction as follows:</p> <ul style="list-style-type: none"> • <p>RAI Response</p> <ul style="list-style-type: none"> • Add the description “(3) Treatment of Dissolved Nitrogen Gas Effect” in Subsection 3.5.1.4 to consist with Section 5.3 in the latest topical report “The Advanced Accumulator MUAP-07001 Revision 4 ” (requested in the 7th set RAIs)

<p>2 (Cont.)</p>	<p>3-34 and 3-35</p> <p>3-36</p> <p>3-62</p> <p>3-70</p> <p>3-94</p> <p>3-95</p> <p>3-96</p> <p>3-97</p> <p>5-1</p> <p>B-3</p> <p>B-6</p>	<p>Technical Change</p> <ul style="list-style-type: none"> • Update Table 3.5-4 to consist with Subsection 5.1.2 (2) in the latest topical report “The Advanced Accumulator MUAP-07001 Revision 4 ” • Update Table 3.5-5 and Table 3.5-6 to consist with Subsection 5.1.2 (1) in the latest topical report “The Advanced Accumulator MUAP-07001 Revision 4 ” <p>Editorial correction as follows:</p> <ul style="list-style-type: none"> • Correct the equation number in Table 3.5-7 from 3.5.1-10 to 3.5.1-11 <p>Editorial correction as follows:</p> <ul style="list-style-type: none"> • Update Table 3.5-8 to consist with Subsection 3.5.1.4 (2) <p>Editorial correction as follows:</p> <ul style="list-style-type: none"> • Correct the transient result to consist with Table 3.3-6 <p>Editorial correction as follows:</p> <ul style="list-style-type: none"> • Correct the values in c) and d) to consist with the sample plant analysis condition <p>Editorial correction as follows:</p> <ul style="list-style-type: none"> • Correct the description of Burn-up in Subsection 3.7.2.2 to consist with the methodology <p>RAI Response</p> <ul style="list-style-type: none"> • <p>Editorial correction as follows:</p> <ul style="list-style-type: none"> • Correct the values in c) and d) to consist with the sample plant analysis condition <p>RAI Response</p> <ul style="list-style-type: none"> • <p>Update the listing of references (Ref.4 and Ref.21)</p> <p>RAI Response</p> <ul style="list-style-type: none"> • Add the description for dissolved nitrogen gas effect to consist with Section 5.3 in the latest topical report “The Advanced Accumulator MUAP-07001 Revision 4 ” (requested in the 7th set RAIs) <p>Update reference B-3 and add reference B-4</p>
<p>3</p>	<p>2-2 and Section3</p>	<p>Editorial corrections</p> <ul style="list-style-type: none"> •Eliminate lines above and below “Figure2-3” in the first paragraph of subsection 2.3.1 in page 2-2 • Modify indents of the third paragraph in page 2-2 and titles of subsection 3.x.x

<p>3 (Cont.)</p>	<p>2-12</p> <p>3-28 and 3-35</p> <p>3-96</p>	<p>Editorial correction</p> <ul style="list-style-type: none"> • Replace “165.4” for Active Fuel Length in Table 2-3 to “165.4 in.” <p>Editorial corrections</p> <ul style="list-style-type: none"> • • <p>Editorial correction</p> <ul style="list-style-type: none"> • Replace “Max.” for f) SG Plugging Level in Table 3.7-1 to “Maximum”
----------------------	--	--

© 2011
MITSUBISHI HEAVY INDUSTRIES, LTD.
All Rights Reserved

This document has been prepared by Mitsubishi Heavy Industries, Ltd. (“MHI”) in connection with its request to the U.S. Nuclear Regulatory Commission (“NRC”) for a pre-application review of the US-APWR nuclear power plant design. No right to disclose, use or copy any of the information in this document, other than that by the NRC and its contractors in support of MHI’s pre-application review of the US-APWR, is authorized without the express written permission of MHI.

This document contains technology information and intellectual property relating to the US-APWR and it is delivered to the NRC on the express condition that it not be disclosed, copied or reproduced in whole or in part, or used for the benefit of anyone other than MHI without the express written permission of MHI, except as set forth in the previous paragraph.

This document is protected by the laws of Japan, U.S. copyright law, international treaties and conventions, and the applicable laws of any country where it is being used.

Mitsubishi Heavy Industries, Ltd.
16-5, Konan 2-chome, Minato-ku
Tokyo 108-8215 Japan

ABSTRACT

In this report, the applicability of the WCOBRA/TRAC(M1.0) code and the ASTRUM method to the evaluation of Large Break Loss of Coolant Accident (LBLOCA) at the US-APWR has been evaluated. Design features specific to the US-APWR have been evaluated and required changes to the model have been identified in the WCOBRA/TRAC code.

The WCOBRA/TRAC code was also approved by the NRC to perform Large Break LOCA analyses for its 2-loop plant designs (Ref.1), and for the AP600 and AP1000 advanced plant designs (Ref.2, 3). These types of plant have some specific features that which are very similar to the US-APWR system, such as Direct Vessel Injection (DVI) and Neutron Reflector (NR).

In particular, the applicability for the advanced accumulator as the new design is confirmed by putting in the modified flow resistance model and performing model validation with a comparison between calculated results and test data. And the applicability for improved designs is confirmed by mainly investigating the model availability of WCOBRA/TRAC(M1.0). In addition to this, the plant model of the WCOBRA/TRAC(M1.0) code for the US-APWR is established and a sample calculation is performed to demonstrate the applicability of the WCOBRA/TRAC(M1.0) code to the US-APWR LBLOCA transient.

This report also presents that the ASTRUM methodology, which comprises WCOBRA/TRAC(M1.0). It has the same applicability to the US-APWR because the treatment of the uncertainty for statistical calculation of LBLOCA in the US-APWR is almost the same as conventional 4-loop PWR plants. Note from this point forward the term 'conventional plants' refers to a typical U.S. 4-loop PWR plant design.

The WCOBRA/TRAC(M1.0) code and the ASTRUM methodology can be used for the purposes of performing best estimate analysis for the US-APWR on the basis of this status. The basis for this conclusion is that when compared to conventional 3- and 4-loop plants, for Large Break LOCA events, no new phenomena are identified for the US-APWR, and the test database that supports validation of this code is applicable to the US-APWR. Also the nodding model of the US-APWR plant intended for the WCOBRA/TRAC(M1.0) code, provided in this report, is available for the US-APWR LBLOCA safety analysis calculation.

Table of Contents

List of Tables	v
List of Figures.....	vi
List of Acronyms.....	viii
1.0 INTRODUCTION.....	1-1
2.0 US-APWR PLANT DESIGN AND FEATURES.....	2-1
2.1 Main Specifications.....	2-1
2.2 Reactor and Core	2-1
2.2.1 General Features	2-1
2.2.2 Fuel Assemblies.....	2-1
2.2.3 Reactor Vessel Internals	2-1
2.3 Reactor Coolant System.....	2-2
2.3.1 General Features	2-2
2.3.2 Reactor Vessel.....	2-3
2.3.3 Steam Generators.....	2-3
2.3.4 Reactor Coolant Pumps.....	2-3
2.3.5 Pressurizer.....	2-4
2.4 Engineered Safety Features.....	2-4
2.4.1 General Features	2-4
2.4.2 Emergency Core Cooling System.....	2-5
2.4.3 Containment Spray System.....	2-7
2.4.4 Containment System.....	2-8
3.0 LBLOCA CODE AND METHODOLOGY	3-1
3.1 Introduction.....	3-1
3.2 US-APWR Features.....	3-1
3.3 Description of US-APWR LBLOCA Transient.....	3-2
3.3.1 General Description	3-2
3.3.2 Blowdown Period	3-2
3.3.3 Refilling Period.....	3-3
3.3.4 Reflooding Period.....	3-3
3.4 Phenomena Identification and Ranking (PIRT)	3-8
3.4.1 LBLOCA PIRT	3-8
3.4.2 Effects of US-APWR Design on Westinghouse PIRT Conclusions.....	3-15
3.5 WCOBRA/TRAC Code Applicability to US-APWR	3-21
3.5.1 Advanced Accumulator	3-21
3.5.2 Direct Vessel Injection (DVI)	3-47
3.5.3 Neutron Reflector.....	3-47
3.6 Sample Plant Analysis	3-55
3.6.1 Nodalization of Plant Analysis.....	3-55
3.6.2 Calculation Process	3-59
3.6.3 Models for Sample Plant Analysis.....	3-59
3.6.4 Analysis Conditions.....	3-61
3.6.5 Analysis Results.....	3-62
3.6.6 Sample Plant Analysis Summary	3-62
3.7 ASTRUM Methodology Applied to US-APWR	3-91
3.7.1 Statistical Methodology of ASTRUM	3-91
3.7.2 ASTRUM Methodology Applicability to US-APWR.....	3-93
4.0 CONCLUSIONS.....	4-1
5.0 REFERENCES.....	5-1

Appendix-A Thermal Properties of Nuclear Fuel RodsA-1
Appendix-B Aadvanced Accumulator Model Built into WCOBRA/TRAC.....B-1

List of Tables

Table 2-1	Comparison of Principal Parameters.....	2-10
Table 2-2	Key Parameters of Core Design.....	2-11
Table 2-3	Fuel Assembly Specification.....	2-12
Table 3.3-1	Typical Sequence of the LBLOCA of US-APWR.....	3-5
Table 3.4-1	US-APWR PIRT (1/2)	3-17
Table 3.4-1	US-APWR PIRT (2/2)	3-18
Table 3.5-1	Phenomena/Model in WCOBRA/TRAC for ACC	3-31
Table 3.5-2	Test Conditions of Full Height 1/2 Scale Test.....	3-32
Table 3.5-3	Analysis Conditions	3-33
Table 3.5-4	Instrument Uncertainties (1/2) (Large Flow)	3-34
Table 3.5-4	Instrument Uncertainties (2/2) (Small Flow).....	3-34
Table 3.5-5	Dispersion of Data from Experimental Equation	3-34
Table 3.5-6	Total Uncertainty of Flow Rate Coefficient(Experimental Equations) for Safety Analysis of US-APWR	3-35
Table 3.5-7	Additional Bias to Flow Rate Coefficient(Experimental Equations).....	3-35
Table 3.5-8	Uncertainty of Water Level for Switching Flow Rates	3-36
Table 3.5-9	Phenomena/Model in WCOBRA/TRAC for NR.....	3-50
Table 3.6-1	Channel Descriptions for US-APWR Vessel Model (1/3).....	3-63
Table 3.6-1	Channel Descriptions for US-APWR Vessel Model (2/3).....	3-64
Table 3.6-1	Channel Descriptions for US-APWR Vessel Model (3/3).....	3-65
Table 3.6-2	Gap Connections for US-APWR Vessel Model (1/3)	3-66
Table 3.6-2	Gap Connections for US-APWR Vessel Model (2/3)	3-67
Table 3.6-2	Gap Connections for US-APWR Vessel Model (3/3)	3-68
Table 3.6-3	Comparison of Rated Characteristics of Various Pumps	3-69
Table 3.6-4	Comparison of Specific Speed of Various Pumps	3-69
Table 3.6-5	Analysis Conditions for US-APWR	3-70
Table 3.6-6	Sequence of Events for US-APWR Sample Transient Analysis	3-71
Table 3.7-1	Uncertainty Treatment for US-APWR (1/2).....	3-96
Table 3.7-1	Uncertainty Treatment for US-APWR (2/2).....	3-97
Table 3.7-2	Local Model Uncertainty Treatment for US-APWR	3-98
Table 3.7-3	Global Model Uncertainty Treatment for US-APWR	3-99

List of Figures

Figure 2-1	Reactor General Assembly	2-13
Figure 2-2	Neutron Reflector Assembly	2-14
Figure 2-3	Reactor Coolant System.....	2-15
Figure 2-4	Reactor Vessel.....	2-16
Figure 2-5	Steam Generator	2-17
Figure 2-6	Reactor Coolant Pump	2-18
Figure 2-7	Pressurizer.....	2-19
Figure 2-8	Simplified Configuration of ECCS and CSS	2-20
Figure 2-9	Emergency Core Cooling System.....	2-21
Figure 2-10	Safety System Performance for US-APWR.....	2-22
Figure 2-11	Containment Spray System	2-23
Figure 2-12	Configuration of Containment Vessel	2-24
Figure 3.3-1	System Configuration of ECCS of US-APWR	3-6
Figure 3.3-2	ECCS Flow Injection Performance during LBLOCA.....	3-6
Figure 3.3-3	Transient of LBLOCA in US-APWR.....	3-7
Figure 3.4-1	Location of Direct Vessel Injection Nozzle	3-19
Figure 3.4-2	Safety Injection Pad of Direct Vessel Injection	3-20
Figure 3.5-1	Principle of Advanced Accumulator	3-37
Figure 3.5-2	Flow Characteristics of Flow Damper.....	3-38
Figure 3.5-3	Schematic Drawing of Full Height 1/2 Scale Test Facility	3-39
Figure 3.5-4	Outline Drawing of Full Height 1/2 Scale Test Facility	3-39
Figure 3.5-5	Nodalization of Full Height 1/2 Scale ACC Test Section	3-40
Figure 3.5-6	Flow Damper Outlet Pressure Given at BREAK (Case 1).....	3-41
Figure 3.5-7 (1/3)	Comparison between Test and Analysis of Flow Rate (Full Height 1/2 Scale Test Case 1)	3-42
Figure 3.5-7 (2/3)	Comparison between Test and Analysis of Integrated Flow Rate (Full Height 1/2 Scale Test Case 1)	3-42
Figure 3.5-7 (3/3)	Comparison between Test and Analysis of Gas Pressure in Test Tank (Full Height 1/2 Scale Test Case 1)	3-43
Figure 3.5-8 (1/3)	Comparison between Test and Analysis of Flow Rate (Full Height 1/2 Scale Test Case 2)	3-43
Figure 3.5-8 (2/3)	Comparison between Test and Analysis of Integrated Flow Rate (Full Height 1/2 Scale Test Case 2)	3-44
Figure 3.5-8 (3/3)	Comparison between Test and Analysis of Gas Pressure in Test Tank (Full Height 1/2 Scale Test Case 2)	3-44
Figure 3.5-9 (1/3)	Comparison between Test and Analysis of Flow Rate (Full Height 1/2 Scale Test Case 3)	3-45
Figure 3.5-9 (2/3)	Comparison between Test and Analysis of Integrated Flow Rate (Full Height 1/2 Scale Test Case 3)	3-45
Figure 3.5-9 (3/3)	Comparison between Test and Analysis of Gas Pressure in Test Tank (Full Height 1/2 Scale Test Case 3)	3-46
Figure 3.5-10	Neutron Reflector Configuration of US-APWR.....	3-51
Figure 3.5-11	Flow Regimes and Heat Transfer Modes at Cooing Holes in Neutron Reflector during Reflooding Period.....	3-52
Figure 3.5-12	Normal Wall Flow Regimes	3-53
Figure 3.5-13	Hot Wall Flow Regimes	3-54
Figure 3.6-1	US-APWR Vessel Profile.....	3-72

Figure 3.6-2	US-APWR Vessel Noding for Hot Assembly Under Guide Tube (Vertical View)	3-73
Figure 3.6-3	US-APWR Vessel Sections 1 to 2 (Horizontal View).....	3-74
Figure 3.6-4	US-APWR Vessel Sections 3 to 4 (Horizontal View).....	3-75
Figure 3.6-5	US-APWR Vessel Sections 5 to 6 (Horizontal View).....	3-76
Figure 3.6-6	US-APWR Vessel Sections 7 to 8 (Horizontal View).....	3-77
Figure 3.6-7	US-APWR Vessel Sections 9 to 10 (Horizontal View).....	3-78
Figure 3.6-8	US-APWR WCOBRA/TRAC(M1.0) Model Vessel/Loop Layout	3-79
Figure 3.6-9	US-APWR RCP Homologous Single-phase and Two-phase Pump Head Curve	3-80
Figure 3.6-10	US-APWR RCP Homologous Single-phase and Two-phase Pump Torque Curve.....	3-81
Figure 3.6-11	US-APWR RCP Two- Phase Head Multiplier	3-82
Figure 3.6-12	US-APWR RCP Two- Phase Torque Multiplier.....	3-83
Figure 3.6-13	Sample Power Shape for US-APWR Analysis	3-84
Figure 3.6-14	Peak Cladding Temperature of Hot Rod.....	3-85
Figure 3.6-15	Hot Assembly Channel Total Flow Rate	3-86
Figure 3.6-16	Core Pressure	3-87
Figure 3.6-17	Lower Plenum Liquid Level	3-88
Figure 3.6-18	Downcomer Liquid Level	3-89
Figure 3.6-19	Accumulator Flow Rate	3-90
Figure B-1	ACC Nodalization	B-7
Figure B-2	Flow Resistance Calculation Diagram in Subroutine ACCUM1	B-8

List of Acronyms

ACC	Accumulator
APWR	Advanced Pressurized-Water Reactor
ASTRUM	Automated Statistical Treatment of Uncertainty Method
BOL	Begin Of Life
CCFL	Countercurrent Flow Limitation
CD	Discharge Coefficient
CHF	Critical Heat Flux
CS	Containment Spray
CSS	Containment Spray System
CV	Containment Vessel
CVCS	Chemical and Volume Control System
CSAU	Code Scaling Applicability and Uncertainty
CE	Combustion Engineering
CWO	Core Wide Oxidation
DCD	Design Control Document
DECLG	Double Ended Cold Leg guillotine
DNB	Departure from Nucleate Boiling
DVI	Direct Vessel Injection
ECC	Emergency Core Cooling
ECCS	Emergency Core Cooling System
EPS	Emergency Power Source
ESF	Engineered Safety Feature
FA	Fuel Assembly
GT	Guide Tube
HA	Hot Assembly
HFP	Hot Full Power
HHSI	High Head Safety Injection
HTC	Heat Transfer Coefficient
ICIS	In-Core Instrumentation System
LBLOCA	Large Break Loss of Coolant Accident
LHSI	Low Head Safety Injection
LOCA	Loss of Coolant Accident
LP	Lower Plenum of reactor vessel
LMO	Local Maximum Oxidation
MHI	Mitsubishi Heavy Industries, Ltd.
MSLB	Main Steam Line Break
MTC	Moderator Temperature Coefficient
NPSH	Net Positive Suction Head
NR	Neutron Reflector
NRC	U.S. Nuclear Regulatory Commission
OLM	On Line Maintenance
OH	Open Hole
PCT	Peak Cladding Temperature
PIRT	Phenomena Identification Ranking Table
PLOW	LOW-Power region
PWR	Pressurized Water Reactor
PZR	Pressurizer

RCCA	Rod Cluster Control Assemblies
RCP	Reactor Coolant Pump
RCS	Reactor Coolant System
RHR	Residual Heat Removal
RV	Reactor Vessel
RVH	Reactor Vessel Head
RVI	Reactor Vessel Internal
RWSP	Refueling Water Storage Pit
SDV	Safety Depressurization Valve
SG	Steam Generator
SI	Safety Injection
SL	Surge Line
SRP	Standard Review Plan
SRV	Safety Relief Valve
Tinlet	Primary coolant temperature at reactor vessel inlet nozzle
TDF	Thermal Design Flow
TMIN	MINimum film boiling Temperature
UP	Upper Plenum of reactor vessel
UCP	Upper Core Plate
UPI	Upper Plenum Injection

1.0 INTRODUCTION

This report describes the acceptability of using of analysis codes and methodologies approved for conventional Pressurized Water Reactors (PWR) in their application to the US-APWR. The basic design of the US-APWR is almost the same as a conventional 4-loop PWR and the thermal hydraulic behavior of the US-APWR during a Large Break Loss of Coolant Accident (LBLOCA) is also almost the same as a conventional 4-loop PWR. Therefore, the LBLOCA analysis methodology for the US-APWR can be applied to the approved methodology for a conventional PWR with several modifications to reflect the US-APWR design features. The methodology is a statistical method with WCOBRA/TRAC.

Chapter 2 describes US-APWR plant design and features in comparison with a conventional 4-loop PWR plant. Major components of the US-APWR that is, the core, fuel assemblies, neutron reflector, reactor vessel, steam generator, reactor coolant pump, pressurizer, and engineered safety features, are described. The ECCS of the US-APWR consists of the accumulators and high head injection system. The US-APWR accumulator plays the role of both a conventional accumulator and a low head injection system by regulating injection flow rate with variable flow chamber resistance, which is dependent on the accumulator water level. The high head injection system consists of four (4) independent trains and injects from the RWSP to the reactor vessel downcomer. The RWSP is located in the lower part of the containment and enables recirculation without switching suction of the high head pumps.

The Chapter 3 describes the LBLOCA code and methodology for the US-APWR based on the US-APWR design and features identified in Chapter 2. The US-APWR uses an already approved statistical method with WCOBRA/TRAC, which is called ASTRUM (Automated Statistical Treatment of Uncertainty Method). First, the general behavior of LBLOCA transients in the US-APWR is described. Then, a Phenomena Identification and Ranking Table (PIRT) is developed and compared to that of a conventional PWR. Although minor differences from the conventional PWR due to the US-APWR design appear in the PIRT, almost all phenomena rankings are the same as the conventional PWR.

Modification and validation of WCOBRA/TRAC for modeling of the US-APWR accumulator are described. Applicability of WCOBRA/TRAC to Direct Vessel Injection (DVI) and the Neutron Reflector (NR) is also discussed.

Finally, a sample calculation model and corresponding results of the US-APWR with WCOBRA/TRAC are provided. The statistical method and treatment of uncertainty in the US-APWR analysis are also presented.

2.0 US-APWR PLANT DESIGN AND FEATURES

This section describes certain aspects of the US-APWR design in order to assist in the understanding the applicability of the approved methodologies for current PWRs to the US-APWR. The US-APWR features highly reliable preventative functions and well-established mitigation systems with active safety functions, and passive safety functions. The primary system design, loop configuration, and main components are similar to those of currently operating PWRs.

2.1 Main Specifications

The US-APWR is an advanced PWR of improved design to enhance reliability while retaining the basic features of conventional 4-loop PWRs. The main specifications of the US-APWR in comparison with current 4-loop PWRs in the U.S. are shown in Table 2-1.

2.2 Reactor and Core

2.2.1 General Features

The reactor configuration of the US-APWR is shown in Figure 2-1. A comparisons of core parameters between the US-APWR and US current 4-loop PWRs are shown in Table 2-2.

The fuel assemblies, rod cluster control assemblies, reactor vessel internals and thermal hydraulic design are described below.

2.2.2 Fuel Assemblies

The fuel assembly consists of the 264 fuel rods arranged in a square 17x17 array, together with 24 control rod guide thimbles, an in-core instrumentation guide tube, 11 grid spacers, and top and bottom nozzles. This design maintains the same grid spacing (approximately 18 inches) as the 17x17 fuel assembly design in current plants. This relatively shorter grid spacing provides greater margin to grid fretting and improves DNB performance in comparison with the widely used standard design of about 14 ft heated length and 10 grid design. Fuel assembly characteristics are shown in Table 2-3.

2.2.3 Reactor Vessel Internals

The arrangement of the reactor vessel internals (RVI) of the US-APWR is shown in Figure 2-1. The increased fuel element length in the US-APWR is enabled by the integration of the lower core plate and lower core support plate.

The coolant flows from the RV inlet nozzles down the annulus between the core barrel and the RV and then into the plenum at the bottom of the RV. The flow then turns and passes through the lower core support plate and into the core. After passing through the core, the coolant enters the upper plenum and then flows radially to the core barrel outlet nozzles. A small amount of coolant flows into the vessel head plenum from the annulus to cool the

vessel head area.

A neutron reflector (NR) is used in the US-APWR to improve neutron utilization and thus the fuel cycle cost, to reduce neutron irradiation of the RV, and to increase structural reliability by eliminating bolts in the high neutron flux region. The NR assembly is shown in Figure 2-2.

The NR is located between the core barrel and core, and lines the core cavity. The NR consists of ten thick stainless steel blocks. These blocks are aligned by alignment pins and fixed to the lower core support plate by tie rods and bolts. The top and bottom are supported and aligned by alignment pins that are welded to the core barrel.

The NR is cooled by up-flow through cooling holes in the blocks. The flow is sufficient to avoid coolant boiling and prevent excessive stress and thermal deflections of the blocks due to gamma heating. The nominal value of total core bypass flow is approximately 7.5% of total reactor coolant system (RCS) flow rate. It is relatively larger than the flow rate at a conventional PWR plant so as to allow enough cooling for the NR and to keep the Reactor Vessel Head (RVH) coolant temperature at T_{inlet} . The total bypass flow is confirmed to be bounded by the design value of 9.0 percent, which includes the uncertainty. Thus, the 9.0% is used in the LBLOCA analysis.

2.3 Reactor Coolant System

2.3.1 General Features

The RCS consists of the RV, the steam generators (SGs), the reactor coolant pumps (RCPs), the pressurizer (PZR) and the reactor coolant pipes and valves. The flow schematic for the RCS is shown in Figure 2-3.

The reactor coolant flows through the hot leg pipes to the SGs and returns to the RV via the cold leg pipes and the RCPs. The PZR is connected to one hot leg via the surge line and to two cold legs via the spray lines.

The reactor coolant system, including connections to related auxiliary systems, constitutes the reactor coolant pressure boundary.

The reactor coolant system performs the following functions.

- Circulates the reactor coolant through the reactor core and transfers heat to the secondary system via the steam generators.
- Cools the core sufficiently to prevent core damage during reactor operation.
- Forms the reactor coolant pressure boundary, which functions as a barrier to prevent radioactive materials in the reactor coolant from being released to the environment.
- Functions as a neutron moderator and reflector and as a solvent for boron.
- Controls the reactor coolant pressure.

The RV, SGs, RCPs, and PZR are individually described below.

2.3.2 Reactor Vessel

The reactor vessel (RV), shown in Figure 2-4, is a vertical cylindrical vessel with hemispherical top and bottom heads. The top head is a removable flanged closure head connected to the RV upper shell flange by stud bolts. Pads on the RV nozzles support the vessel.

The RV has four inlet nozzles, four outlet nozzles and four Direct Vessel Injection (DVI) nozzles, which are located between the upper reactor vessel flange and the top of the core, so as to maintain coolant in the reactor vessel in the case of leakage in the reactor coolant loop.

2.3.3 Steam Generators

The SGs, shown in Figure 2-5, are vertical shell U-tube evaporators with integral moisture separating equipments.

The design of the SGs for the US-APWR has been improved to attain high efficiency and reliability by adopting 3/4 inch (19.05 mm) outer diameter tubes made of alloy 690 thermal treated, which are arranged triangularly in 1 inch (25.4mm) pitch.

The reactor coolant enters the tube inlet plenum via the hot side primary coolant nozzle, flows through the inverted U-tubes, transferring heat from the primary side to the secondary side, and leaves from the SG lower head via the cold side primary coolant nozzle. The lower head is divided into inlet and outlet chambers by a vertical partition plate extending from the apex of the lower head to the tube sheet.

Steam generated on the shell side (secondary side) flows upward and exits through the outlet nozzle at the top of the vessel. Feedwater enters the steam generator at an elevation above the top of the U-tubes through a feedwater nozzle. The feedwater enters a feeding and is distributed through nozzles attached to the top of the feeding.

2.3.4 Reactor Coolant Pumps

The reactor coolant pumps (RCPs) for the US-APWR are upsized versions of the Type 93A pumps used in conventional Westinghouse's design PWRs. Their design is similar to that of the Type 93A RCPs.

The RCPs of US-APWR, shown in Figure 2-6, are vertical, single-stage, centrifugal, shaft seal units, driven by three-phase induction motors. The shaft is vertical with the motor mounted above the pump. A flywheel on the shaft above the motor provides additional inertia to extend pump coastdown. The pump suction is at the bottom, and the discharge is located on the side.

The reactor coolant that enters from the bottom of the casing is accelerated by the impeller and causes a pressure increase across the diffuser. The diffuser is located at the center of the casing in order to attain high hydraulic efficiency.

The US-APWR reactor coolant pump has achieved larger capacity and higher efficiency than those of the Type 93A pump by improving of the impeller and diffuser configuration.

2.3.5 Pressurizer

The pressurizer (PZR), shown in Figure 2-7, is a vertical, cylindrical vessel with hemispherical top and bottom heads. The PZR is connected to one hot leg of the reactor coolant loops via the surge line and to two cold legs via the spray lines.

Electrical immersion heaters in the bottom head and the spray nozzle located in the top head control the primary system pressure.

The relief and safety valves at the top head provide overpressure protection of the RCS. The overpressure protection function of the US-APWR is performed as follows.

- Spring-loaded safety relief valves (SRVs) are installed on separate relief lines at the top of the pressurizer.
- An additional relief line has motor-operated relief valves for safety depressurization valves (SDVs). The valves are arranged in parallel and are driven by motor operators. A remotely controlled, motor-operated isolation valve is installed upstream of each the SDVs to allow isolation in the event of a leak.
- The relief lines discharge steam and water into the pressurizer relief tank inside the containment.
- Safety relief valves are installed in each residual heat removal system to provide overpressurization protection for unacceptable combinations of high reactor coolant system pressure and low reactor coolant system temperature.

2.4 Engineered Safety Features

2.4.1 General Features

The engineered safety features (ESFs) serve to mitigate the consequences of a design basis accident in which radioactive fission products are released from the reactor coolant system. The ESFs consist of the emergency core cooling system (ECCS), containment spray system (CSS), containment system, annulus air cleanup system and main control room heat, ventilation and air conditioning system.

The simplified configuration of the ECCS and CSS is shown in Figure 2-8.

The US-APWR employs the following advanced technologies for the ECCS and CSS to enhance its simplification.

a. Four-train, Direct Vessel Injection for High Head Injection System

The US-APWR employs a 4-train direct vessel injection (DVI) system. This system configuration increases redundancy and independence, and enhances safety and reliability. The capacity of each train is 50% of the capacity of a single train of a conventional two train system. Inter-connecting piping between each train is also eliminated.

The support system and the emergency AC power supply system also adopt a 4-train

configuration to enhance the reliability of the system.

b. Emergency Water Storage inside the Containment

The US-APWR eliminates potentially high risk operator actions to realign the suction in an emergency such as a Loss of Coolant Accident (LOCA) by installing the Refueling Water Storage Pit (RWSP) inside the containment. The RWSP is formed with a lined concrete structure and works as the emergency water source. This design significantly contributes to lowering the estimated core damage frequency.

c. Passive Low Head Injection

The safety system of the US-APWR consists of an optimized combination of active and passive components. The advanced accumulator is a passive component employed to enhance safety by improving flow injection characteristics and eliminating the need of the low head injection system. By adopting the vortex damper mechanism, the advanced accumulator supplies water with a large flow rate at the early stage of LOCA, and lower flow rate at the later stages.

The ECCS, CSS and containment system are described below.

2.4.2 Emergency Core Cooling System

The ECCS, shown in Figure 2-9, includes the accumulator system, high head injection system and emergency letdown system. The ECCS injects borated water into the reactor coolant system following a postulated accident and performs the following functions:

- Following a loss-of-coolant accident, the ECCS cools the reactor core, prevents serious damage to the fuel and fuel cladding, and limits the zirconium-water reaction in the fuel cladding to a very small amount.
- Following a main steam line break (MSLB), the ECCS provides negative reactivity to shut down the reactor.
- In the event that the normal CVCS letdown and boration capability are lost, the ECCS provides emergency letdown and boration of the RCS to systematically shutdown the reactor.

Compliance of the US-APWR ECCS with the 10 CFR 50.46 acceptance criteria is evaluated by ECCS Performance Analysis.

The ECCS is designed to perform the following major safety-related functions:

- Safety Injection
- Safe Shutdown
- Containment pH Control

These functions are provided by safety-related equipment with redundancy to deal with single failure, environmental qualification, and protection from external hazards.

· Safety Injection

The primary function of the ECCS is to remove stored and fission product decay heat from the reactor core following an accident. The ECCS meets the acceptance criteria of 10CFR50.46(b) for the following items:

- Peak cladding temperature
- Maximum calculated cladding oxidation
- Maximum hydrogen generation
- Coolable core geometry
- Long-term cooling

The ECCS automatically initiates with redundancy sufficient to ensure these functions are accomplished, even in the unlikely event of the most limiting single failure occurring coincident with, or during the event.

The Safety Injection System (SIS), in conjunction with the rapid insertion of the control rod cluster assemblies (reactor scram), provides protection in the following events:

- LOCA
- Ejection of a control rod cluster assembly
- Secondary steam system piping failure
- Inadvertent opening of main steam relief or safety valve
- SG tube rupture

· Safe Shutdown

The portions of the ECCS also operate in conjunction with the other systems of the cold shutdown design. The primary function of the ECCS during a safety grade cold shutdown is to ensure a means for feed and bleed for boration, and make up water for compensation of shrinkage.

· Containment pH Control

NaTB baskets are located in the containment and are capable of maintaining the desired post-accident pH conditions in the recirculation water. The pH adjustment is capable of maintaining containment water pH at least 7.0, to enhance the retention capacity in the containment and to avoid stress corrosion cracking of the austenitic stainless steel components.

2.4.2.1 Accumulator System

The accumulator system stores borated water under pressure and automatically injects it if the reactor coolant pressure decreases significantly. The accumulator system consists of four accumulators and the associated valves and piping, one for each RCS loop. The system is connected to the cold legs of the reactor coolant piping and injects borated water when the RCS pressure falls below the accumulator operating pressure. The system is passive. Pressurized nitrogen gas forces borated water from the tanks into the RCS.

As shown in Figure 2-10 accumulators incorporate internal passive flow dampers and a stand pipe which inject a large flow to refill the reactor vessel during the first stage of injection, and then reduce the flow as the water level in the accumulator drops. When the water level is above the top of the standpipe, water enters the flow damper through both inlets at the top of the standpipe and at the side of the flow damper such that water is injected at a large flow rate. When the water level drops below the top of the standpipe, water enters the flow damper only through the side inlet, so that accumulator injects water at a relatively low flow rate.

The accumulators provide large flow injection to refill the reactor vessel and continue with small flow injection during core reflooding in conjunction with the safety injection pumps.

The combined performance of the accumulator system and the high head injection system eliminates the need for a conventional low head injection system. The accumulator system's performance for the US-APWR is shown in Figure 2-10.

2.4.2.2 High Head Injection System

The direct vessel injection (DVI) is employed for the high head injection system. The high head injection system consists of four independent trains, each containing a safety injection pump and the associated valves and piping. The safety injection pumps start automatically upon receipt of the safety injection signal. One of four independent safety electrical buses is available to each safety injection pump.

The safety injection pumps are aligned to take suction from the refueling water storage pit and to deliver borated water to the DVI nozzles in the reactor vessel. Two safety injection trains are capable of meeting the design cooling function for a Large Break LOCA, assuming a single failure in one train and another train out of service for maintenance. In conventional PWRs, the requirement for a Large Break LOCA is met through a low head injection pump that generally serves also as an RHR pump. Therefore, the capacity of the US-APWR high head injection pump is larger than the conventional high head pump in order to provide sufficient flow during the large break LOCA.

The refueling water storage pit in the containment provides a continuous borated water source for the safety injection pumps, thus eliminating the need for realignment from the refueling water storage pit to the containment sump.

2.4.2.3 Emergency Letdown System

The emergency letdown system performs a "feed and bleed" (FAB) letdown boration to establish cold shutdown conditions if the normal chemical and volume control system (CVCS) is unavailable. The emergency letdown system directs the reactor coolant from two reactor vessel hot legs (B and D) to the refueling water storage pit, from which highly borated water can be returned to the reactor vessel using the safety injection pumps.

2.4.3 Containment Spray System

The containment spray system (CSS), shown in Figure 2-11, consists of four independent trains, each containing a containment spray/residual heat removal (CS/RHR) heat exchanger, a CS/RHR pump, spray nozzles, piping and valves. The CS/RHR heat exchangers and the CS/RHR pumps are used for both CSS and RHRs function. The CSS sprays borated water into the containment vessel in the event of a loss-of-coolant accident.

The containment spray system functions to maintain the containment vessel internal peak pressure below the design pressure and reduce it to approximately atmospheric pressure in the event of a loss of coolant accident or a main steam line break.

The CSS is designed based on the following.

- Its safety functions can be accomplished if there is a single failure of an active component for a short term following an accident with one train out of service for

maintenance, or a single failure of an active component or a single failure of a passive component for a long term following an accident with one train out of service for maintenance.

- The emergency power source can supply electrical power to the essential equipment of the CSS, so that safety functions can be maintained during a loss of offsite power.
- The CSS is automatically initiated by a containment spray signal.
- The CSS design permits periodic tests and inspections to verify integrity and operability.
- The CSS is capable of reducing the containment pressure to less than 50% of the peak calculated pressure for the design basis loss-of-coolant accident within 24 hours after the postulated accident.

The CSS is automatically actuated on receipt of a containment spray signal. When the signal is received, the CS/RHR heat exchanger outlet valves open and the CS/RHR pumps start. The CS/RHR pump motor is connected to a safety bus, so the emergency power source can supply electrical power in case of a loss of offsite power. The CS/RHR pumps take suction from the refueling water storage pit, and the stop valve on the inlet line is always open during reactor operation. The spray water is cooled by the CS/RHR heat exchangers and is delivered to the spray headers located at the top of the containment vessel.

The refueling water storage pit (RWSP) in the containment provides a continuous suction source for the CS/RHR pumps, thus eliminating the need for realignment from the refueling water storage pit to the containment sump.

The safety system pumps (CS/RHR pumps and safety injection pumps), which require sufficient net positive suction head (NPSH) to draw water from the recirculation sumps inside the containment, are located at the lowest level of the reactor building to secure the required NPSH. Also, they are located adjacent to the containment to minimize pipe lengths.

2.4.4 Containment System

The containment system includes the containment vessel, the annulus enclosing the containment penetration area, and the containment isolation function performed by the isolation valves, airlocks and equipment hatch.

The containment system provides an effective leak-tight barrier and environmental radiation protection under all postulated conditions, including a loss-of-coolant accident.

2.4.4.1 Containment Vessel

The containment vessel is designed to completely enclose the reactor and reactor coolant system and to ensure that essentially no leakage of radioactive materials to the environment would result even if a major failure of the reactor coolant system were to occur. The configuration of containment vessel is shown in Figure 2-12.

The containment vessel consists of a prestressed, post-tensioned concrete structure with a cylindrical wall, a hemispherical dome, and a flat reinforced concrete foundation slab. The

inside surface of the structure is lined with carbon steel.

The design pressure and temperature of the containment vessel are defined by the following postulated accidents.

- Loss- of-coolant accident (LOCA)
- Main steam line break (MSLB)

The containment vessel is designed to contain the energy and radioactive materials that result from a postulated loss-of-coolant accident, and for an 68 psig internal pressure to ensure a high degree of leak tightness during normal operation and under accident conditions.

An internal polar crane is supported by the containment vessel. A continuous crane girder transfers the polar crane loads to the containment vessel wall.

Hydrogen igniters are provided for protection against possible detonation following a core damage accident.

2.4.4.2 Refueling Water Storage Pit

The refueling water storage pit (RWSP) is located in the lowest part of the containment vessel. The RWSP provides a continuous suction source for both the safety injection pumps and the CS/RHR pumps. The wall and the floor of the RWSP are lined with stainless steel liner plates. The RWSP has four recirculation sumps on the floor; these sumps are provided with recirculation screens.

Table 2-1 Comparison of Principal Parameters⁽¹⁾⁽²⁾

Parameter	US-APWR	US Current 4-loop PWR	Ratio
Core Thermal Output (MWt)	4,451	3,565 (3853)	1.25
Operation Pressure (psia)	2,250	2,250 (2250)	-
Hot Leg Temperature (deg. F)	617	620 (626)	-
Cold Leg Temperature (deg. F)	551	557 (559)	-
Thermal Design Flow (gpm/loop)	112,000	93,600	1.20
Number of Fuel Assembly	257	193 (193)	1.33
Fuel Assembly Lattice	17x17	17x17	-
Effective Fuel Length (ft)	14	12 (14)	-
Number of Fuel Rods per FA	264	264	-
Average Linear Heat Rate (kW/ft)	4.6	5.7 (5.2)	0.8
Number of RCCAs	69	53 (57)	1.30
Number of Control Rods per RCCA	24	24 (24)	-
SG Heat Transfer Area (ft ²)	91,500	55,000	1.66
PZR Volume (ft ³)	2,900	1,800	1.6
PZR Volume to Thermal Power (ft ³ /MWt)	0.65	0.50	1.3
Containment Design Pressure (psig)	68	52 (56.5)	-

(1) Vogtle Unit #1 is used as the U.S. current 4-loop PWR design.

(2) Data in parentheses are specific to South Texas Project Unit 1 and 2, a current 4-loop PWR using 14-ft fuel. They were retrieved from the database of International Nuclear Safety Center and last updated on 01/97.

Table 2-2 Key Parameters of Core Design

Parameter	US-APWR	US Current 4-loop PWR
Core Thermal Output	4,451 MWt	3,565MWt
Heat Generated in Fuel	97.4 %	97.4 %
Number of Fuel Assemblies	257	193
Fuel Assembly Lattice	17x17	17x17
Effective Fuel Length	14 ft	12 ft
Average Linear Heat Rate	4.6 kW/ft	5.7 kW/ft
Primary System Pressure	2,250 psia	2,250 psia
Thermal Design Flow (TDF)	448,000 gpm	374,400 gpm
Coolant Temperature		
Hot Leg	617 °F*	620 °F*
RV Average	584 °F*	588 °F*
Cold Leg	551 °F*	557 °F*
Core Bypass Flow	7.5 %** 9.0%***	6.3 %

* Given as approximate figures

** Including margin

*** Including uncertainty for LOCA Analysis

Table 2-3 Fuel Assembly Specification

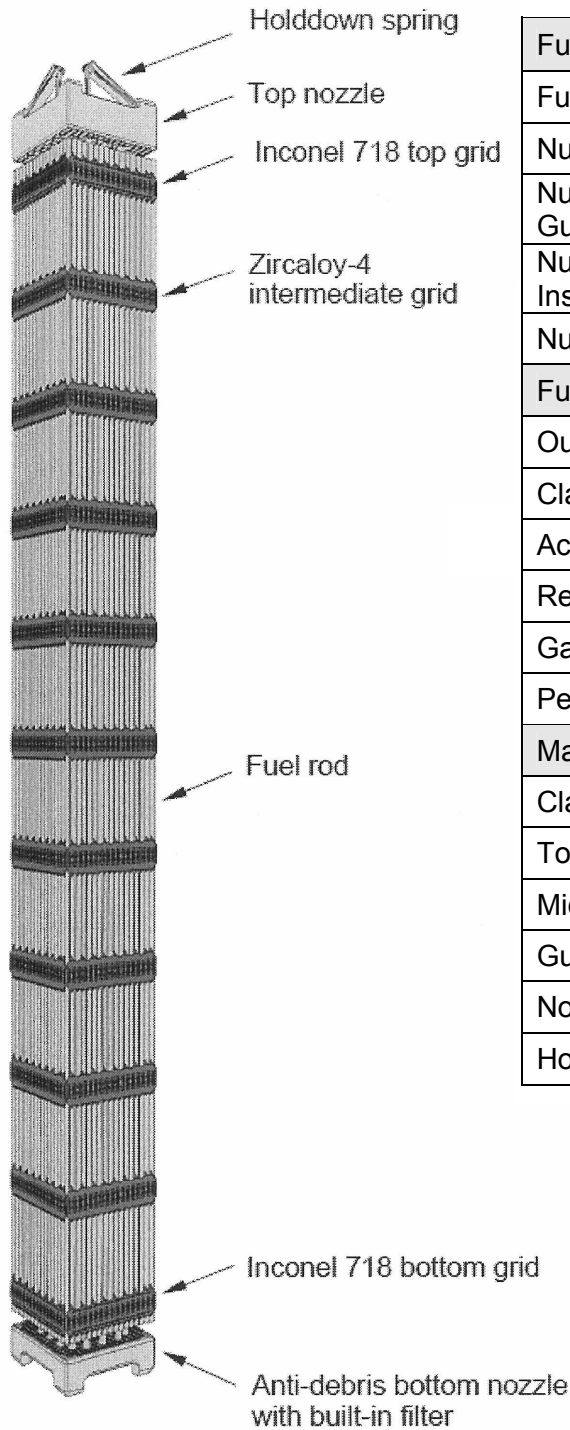

Fuel Assemblies	
Fuel Rods Array	17 x 17
Number of Fuel Rods	264
Number of Control Rod Guide Thimbles	24
Number of In-core Instrumentation Guide Tube	1
Number of Grid Spacers	11
Fuel Rods	
Outside Diameter	0.374 in. (9.50mm)
Cladding Thickness	0.022 in. (0.57mm)
Active Fuel Length	165.4 in. (4,200mm)
Reload Fuel Enrichment	Max. 5 wt%
Gadolinia Content	Max. 10 wt%
Pellet Density	97 %TD
Materials	
Cladding	ZIRLO™
Top & Bottom Grids	Inconel 718
Middle Grids	Zircaloy-4
Guide Thimbles	Zircaloy-4
Nozzles	Stainless Steel
Holddown Springs	Inconel 718

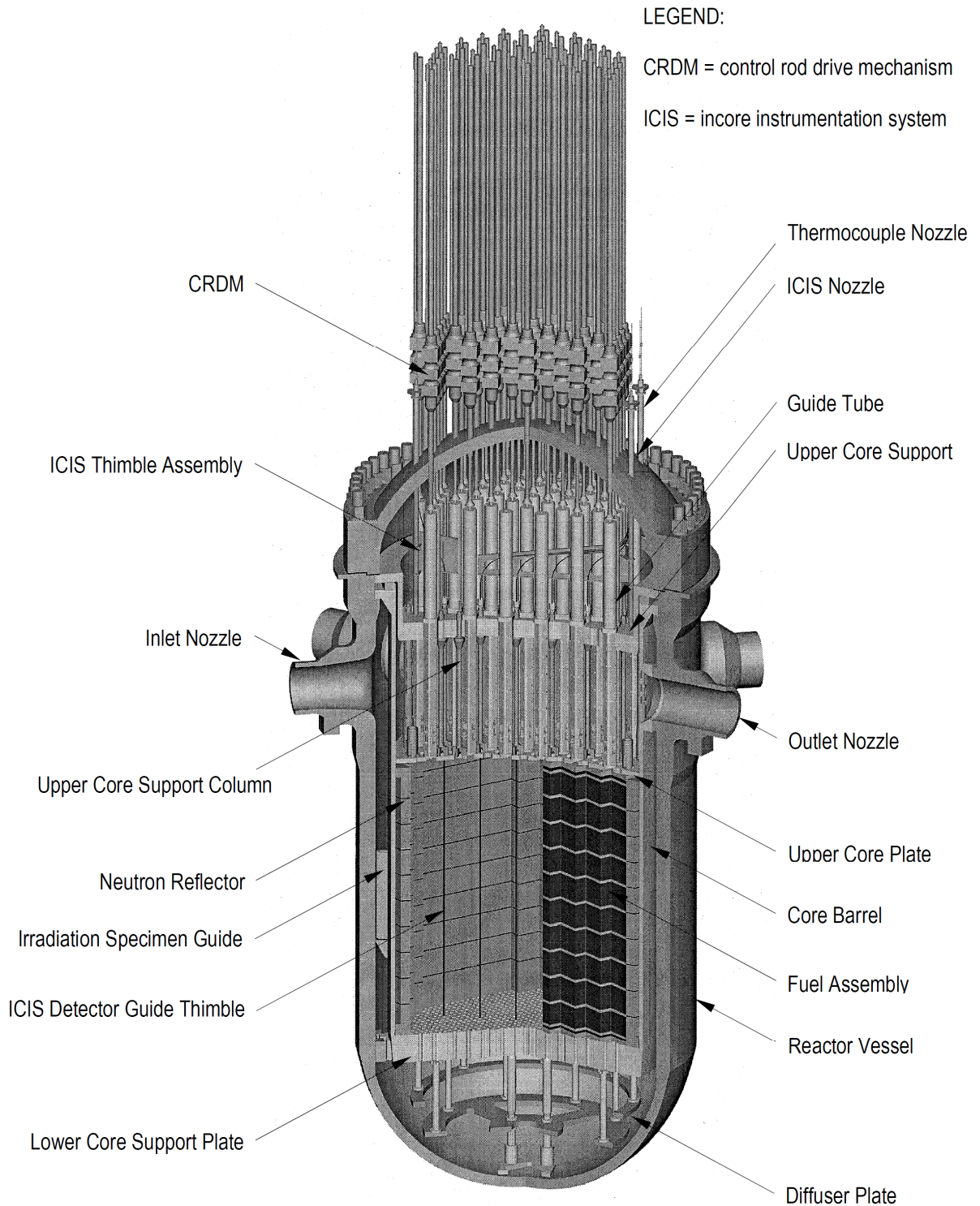

Figure 2-1 Reactor General Assembly

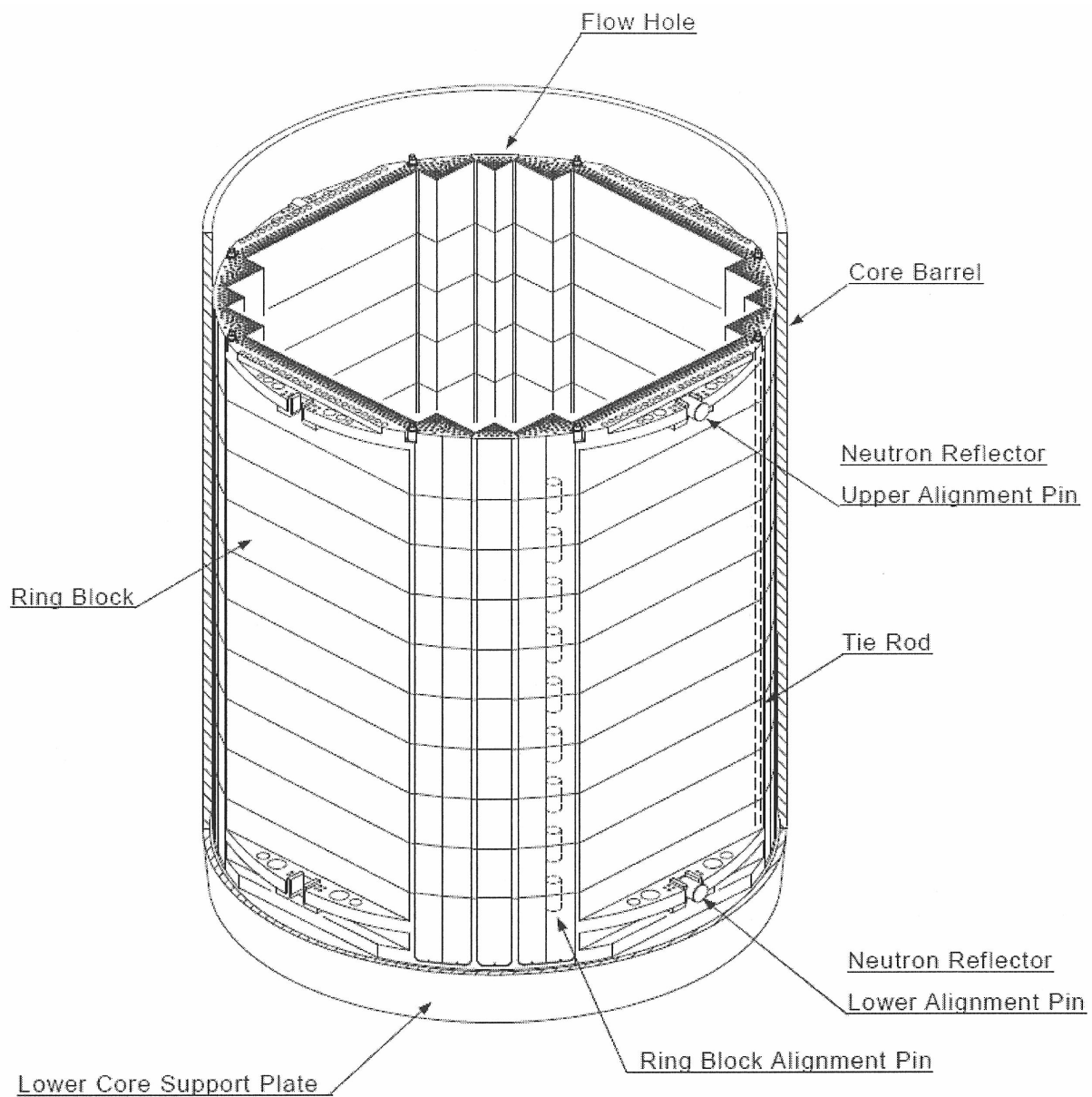

Figure 2-2 Neutron Reflector Assembly

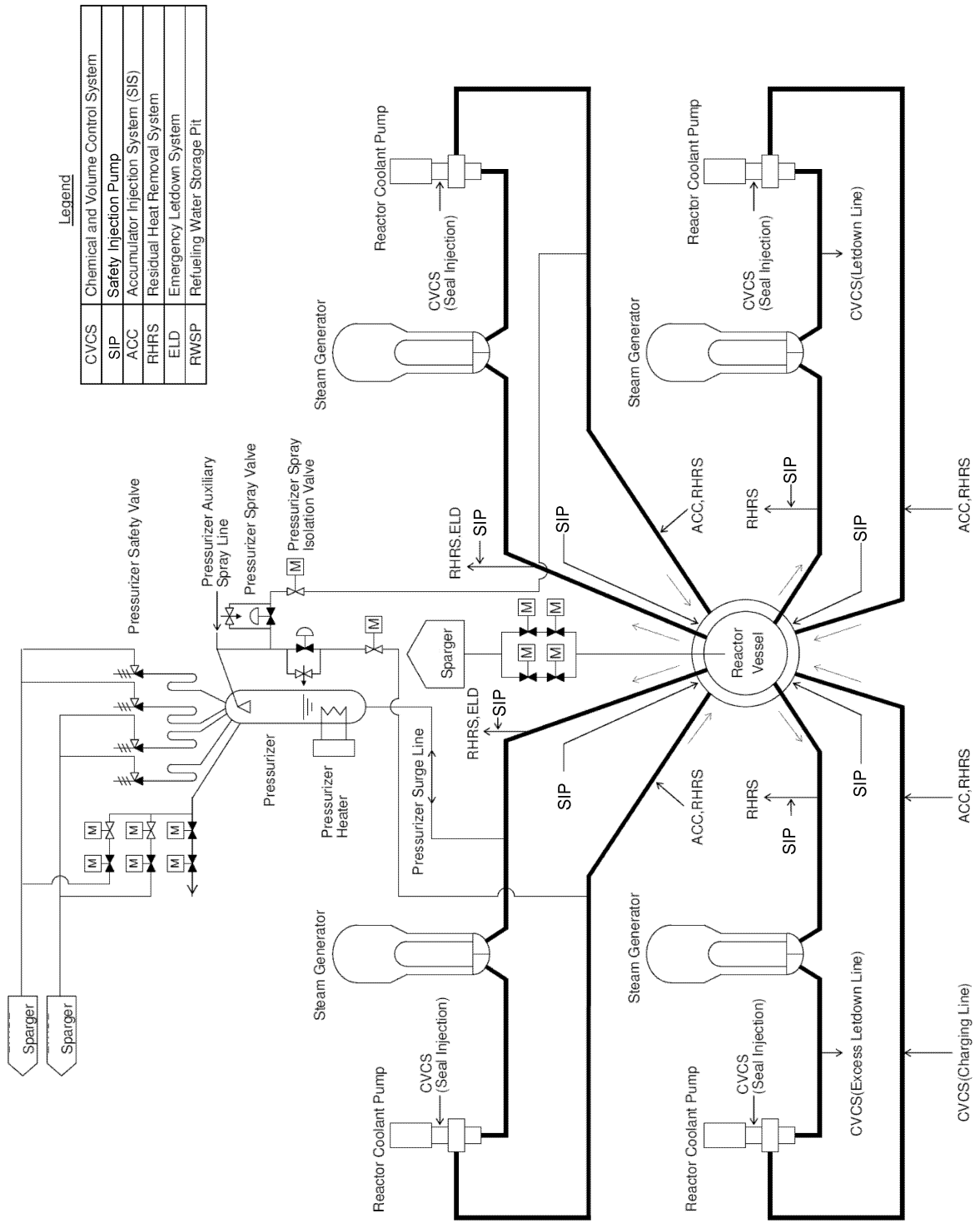

Figure 2-3 Reactor Coolant System

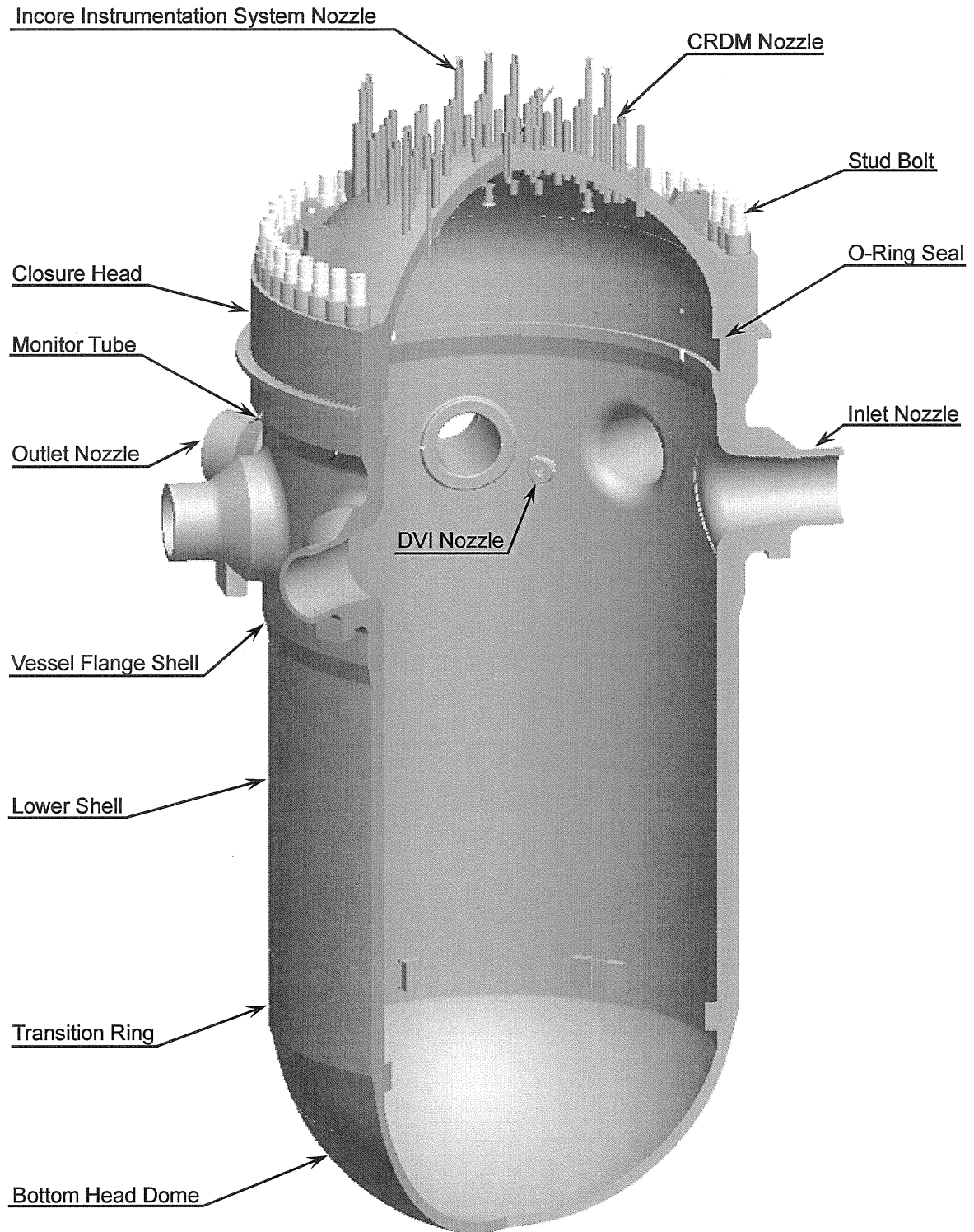

Figure 2-4 Reactor Vessel

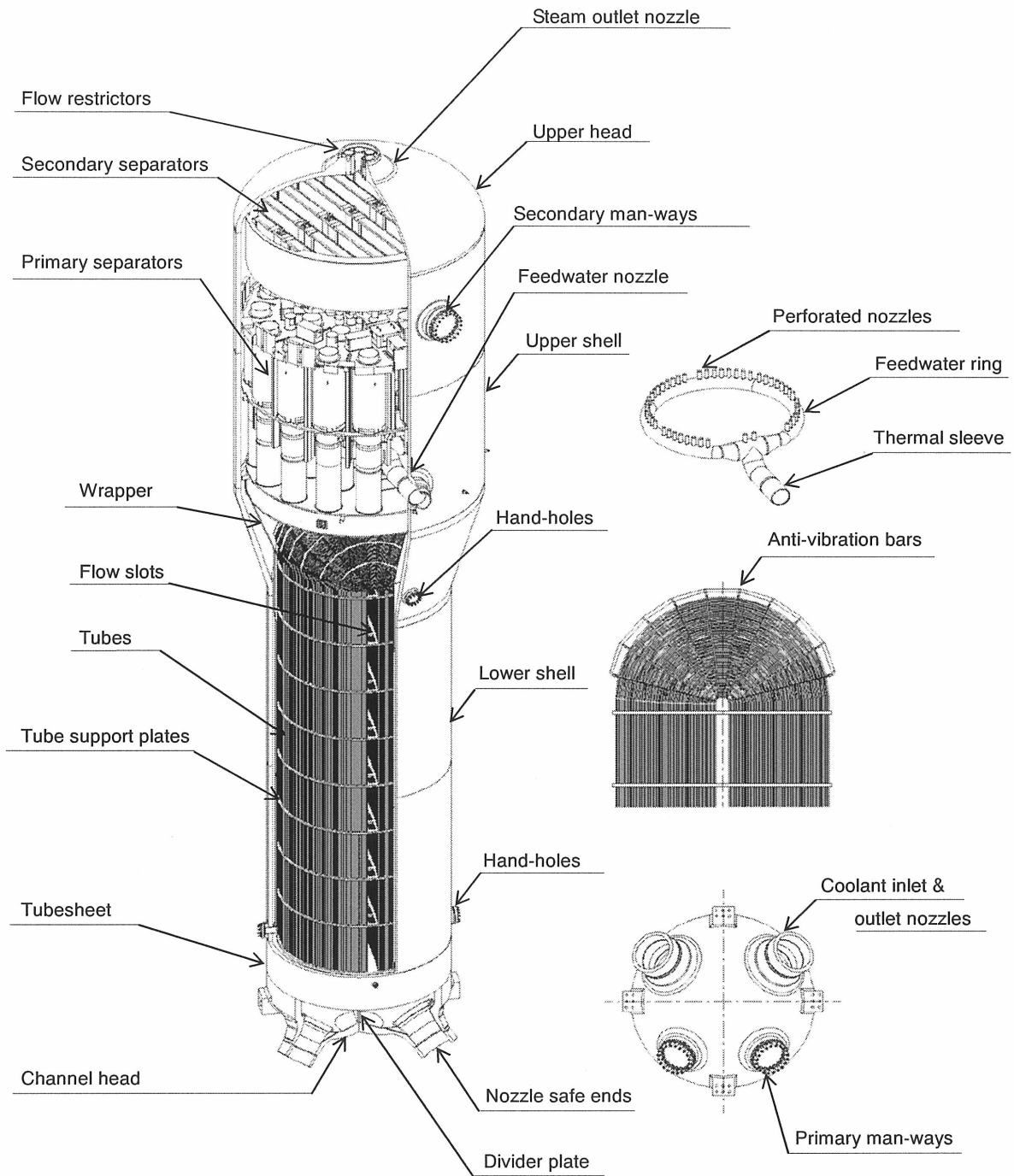

Figure 2-5 Steam Generator

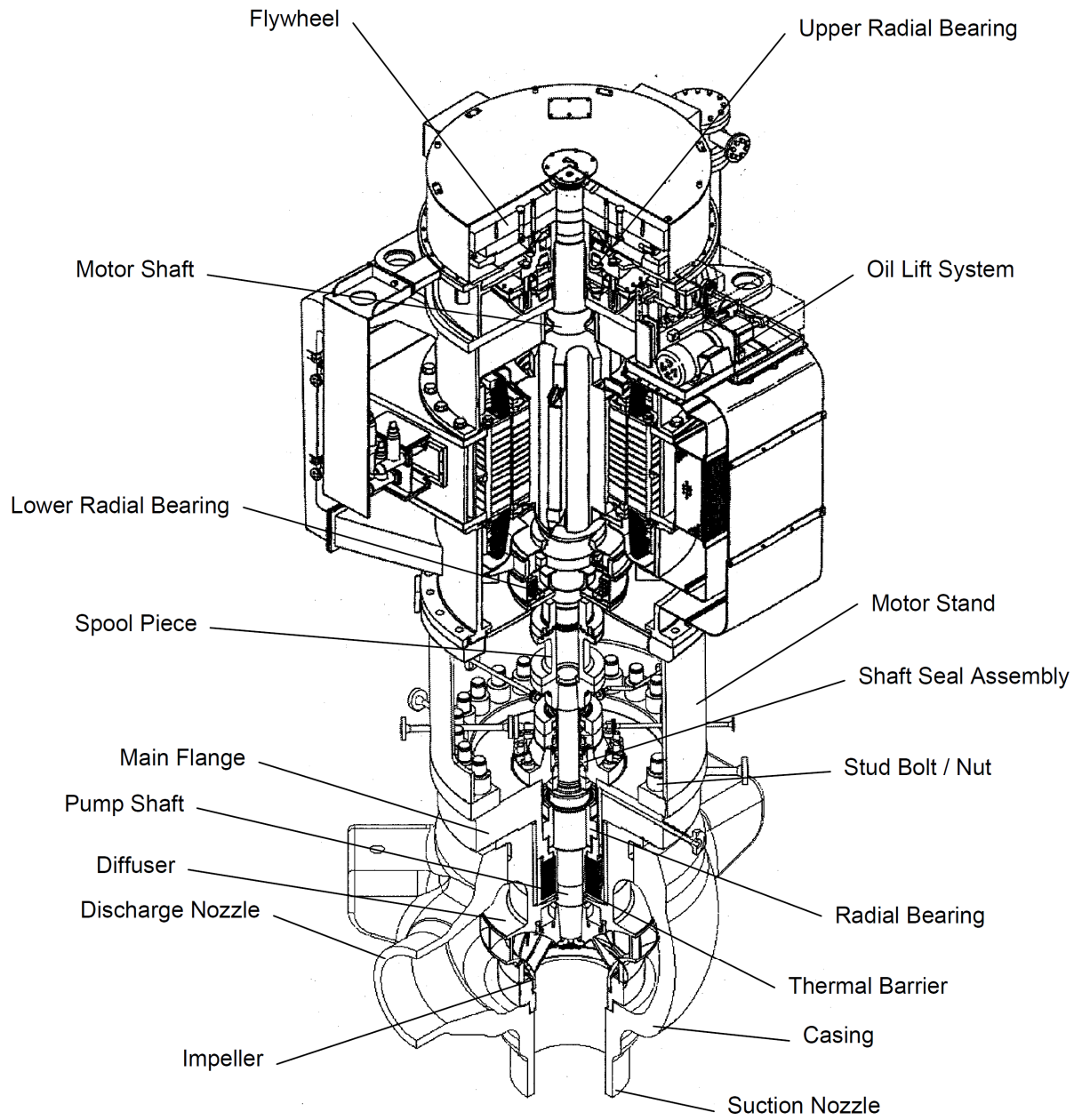

Figure 2-6 Reactor Coolant Pump

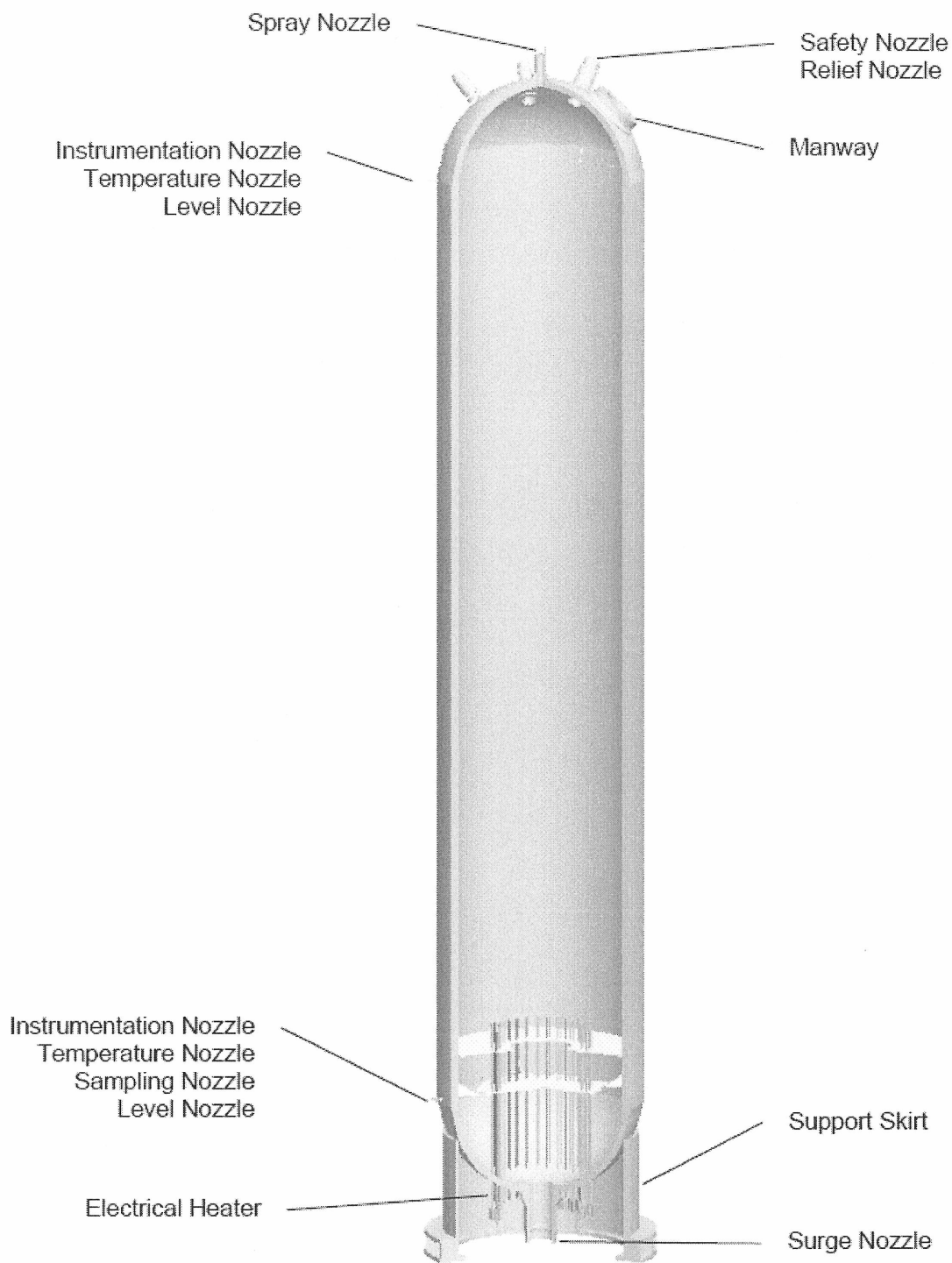
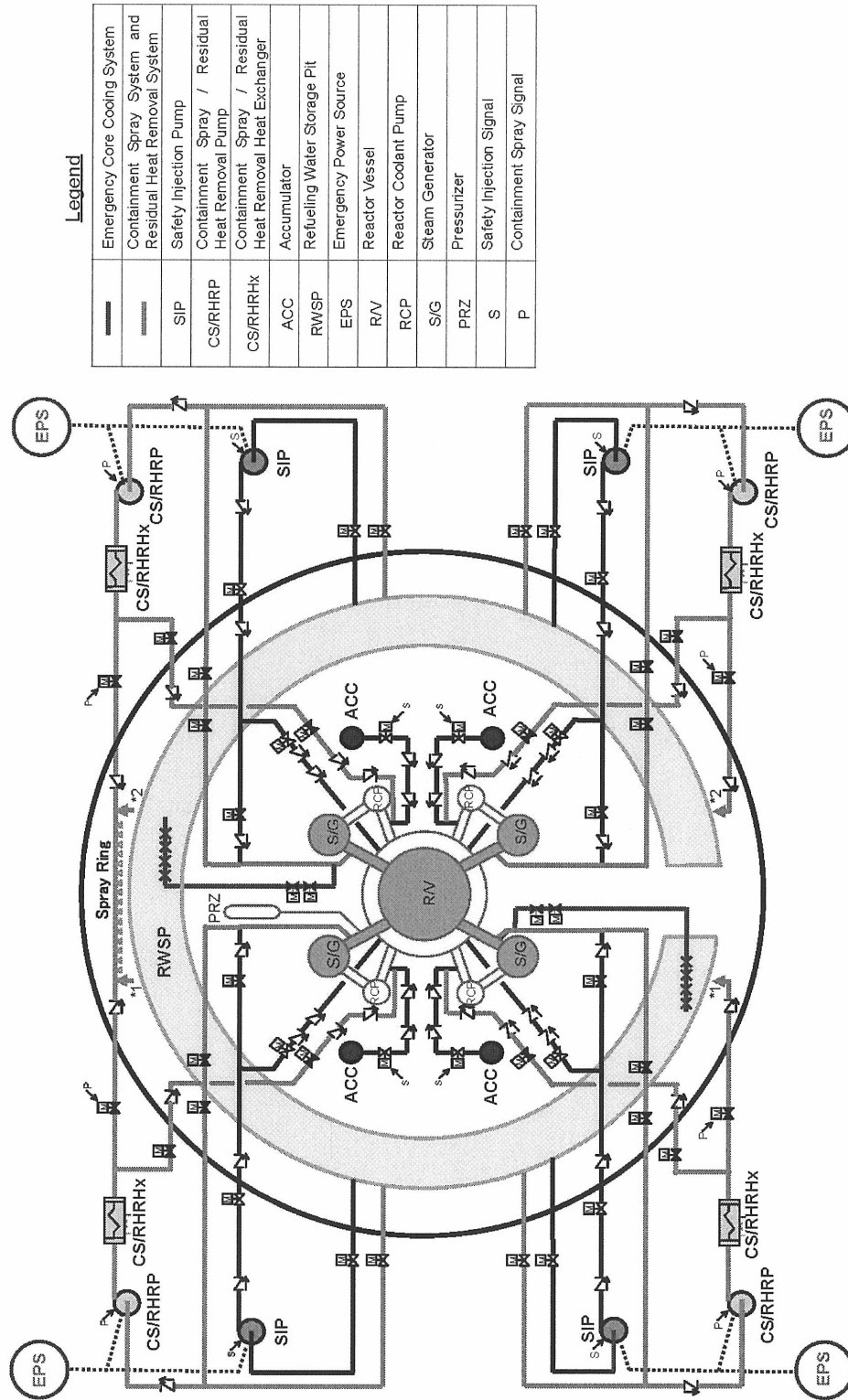

Figure 2-7 Pressurizer



Legend

—	Emergency Core Cooling System
---	Containment Spray System and Residual Heat Removal System
SIP	Safety Injection Pump
CS/RHRP	Containment Spray / Residual Heat Removal Pump
CS/RHRX	Containment Spray / Residual Heat Removal Heat Exchanger
ACC	Accumulator
RWSP	Refueling Water Storage Pit
EPS	Emergency Power Source
R/V	Reactor Vessel
RCP	Reactor Coolant Pump
S/G	Steam Generator
PRZ	Pressurizer
S	Safety Injection Signal
P	Containment Spray Signal

Figure 2-8 Simplified Configuration of ECCS and CSS

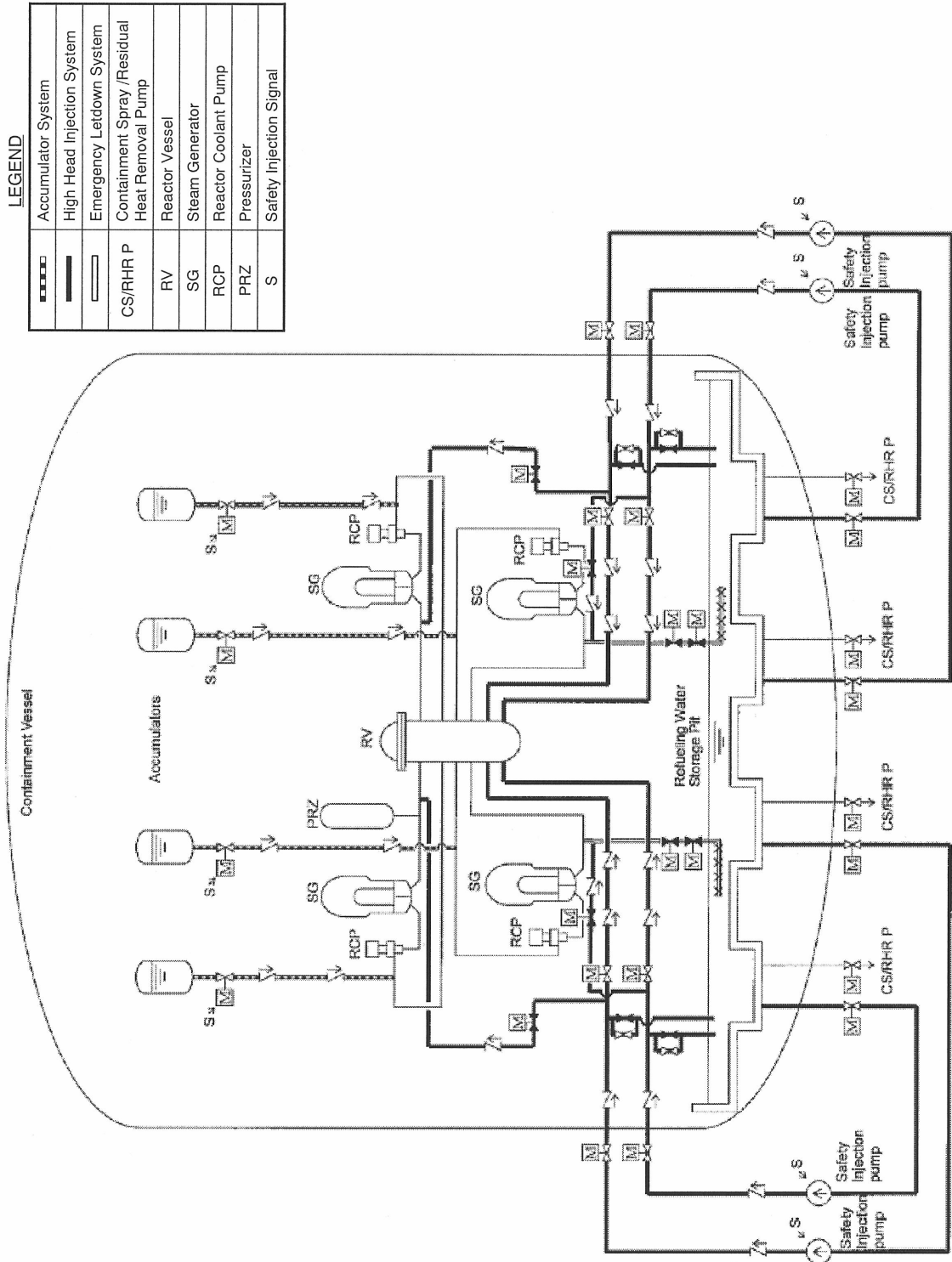

Figure 2-9 Emergency Core Cooling System

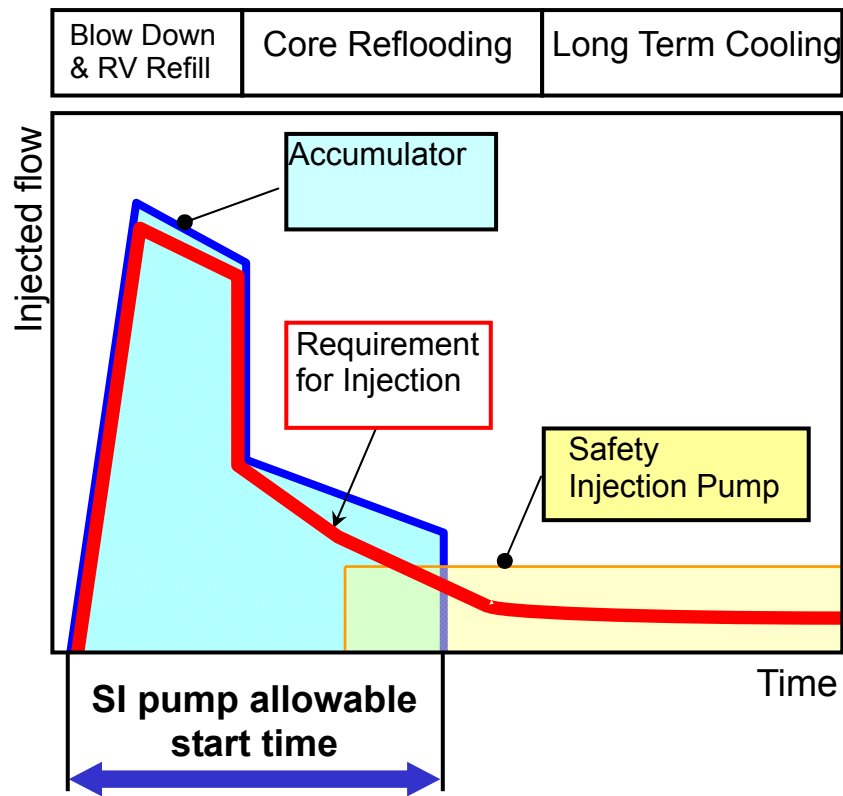
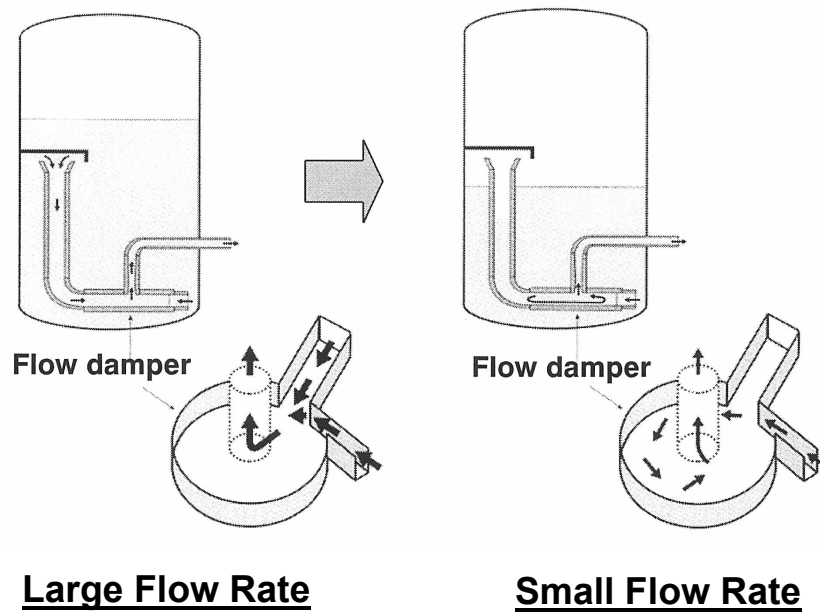

Figure 2-10 Safety System Performance for US-APWR

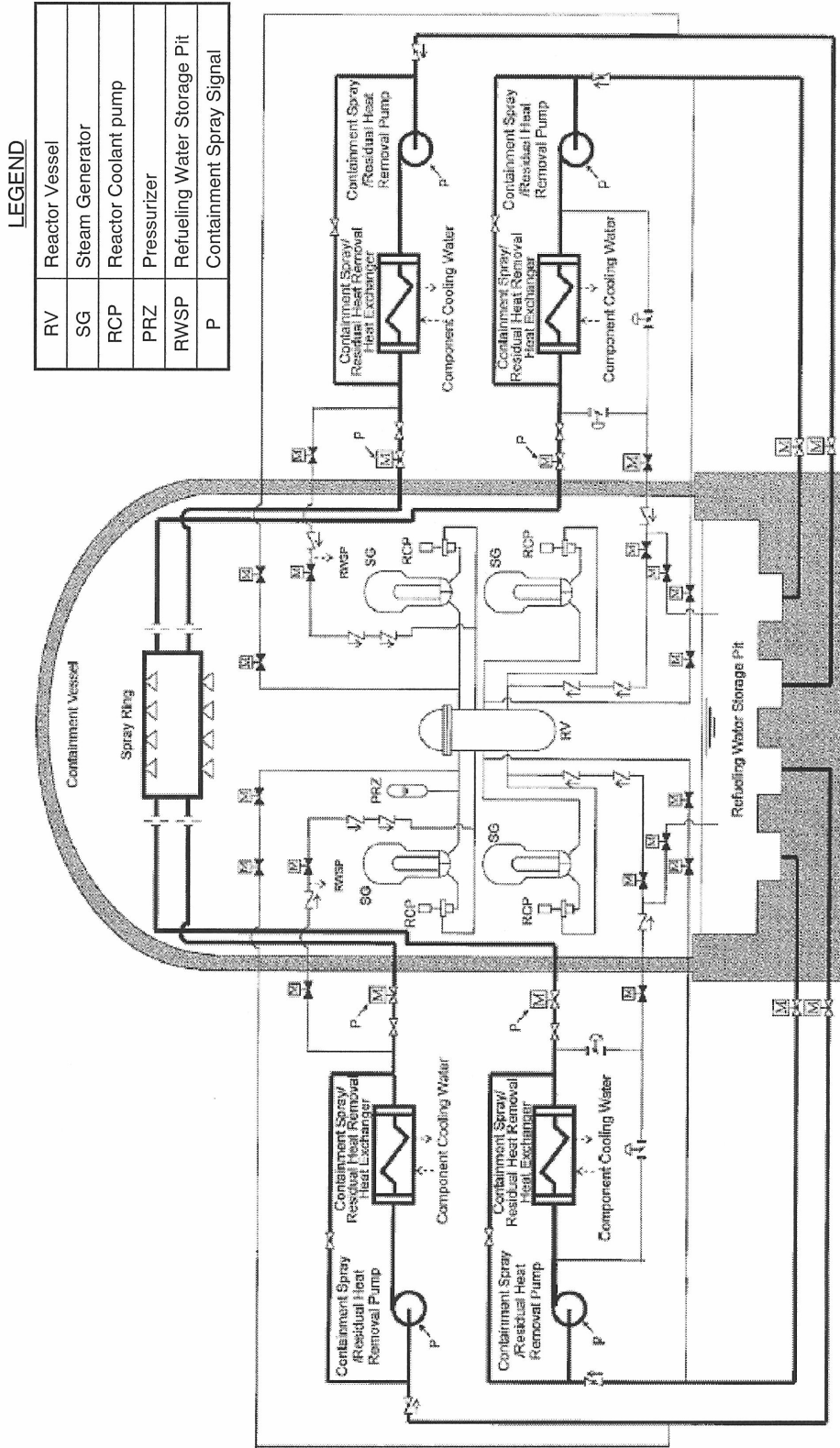

Figure 2-11 Containment Spray System

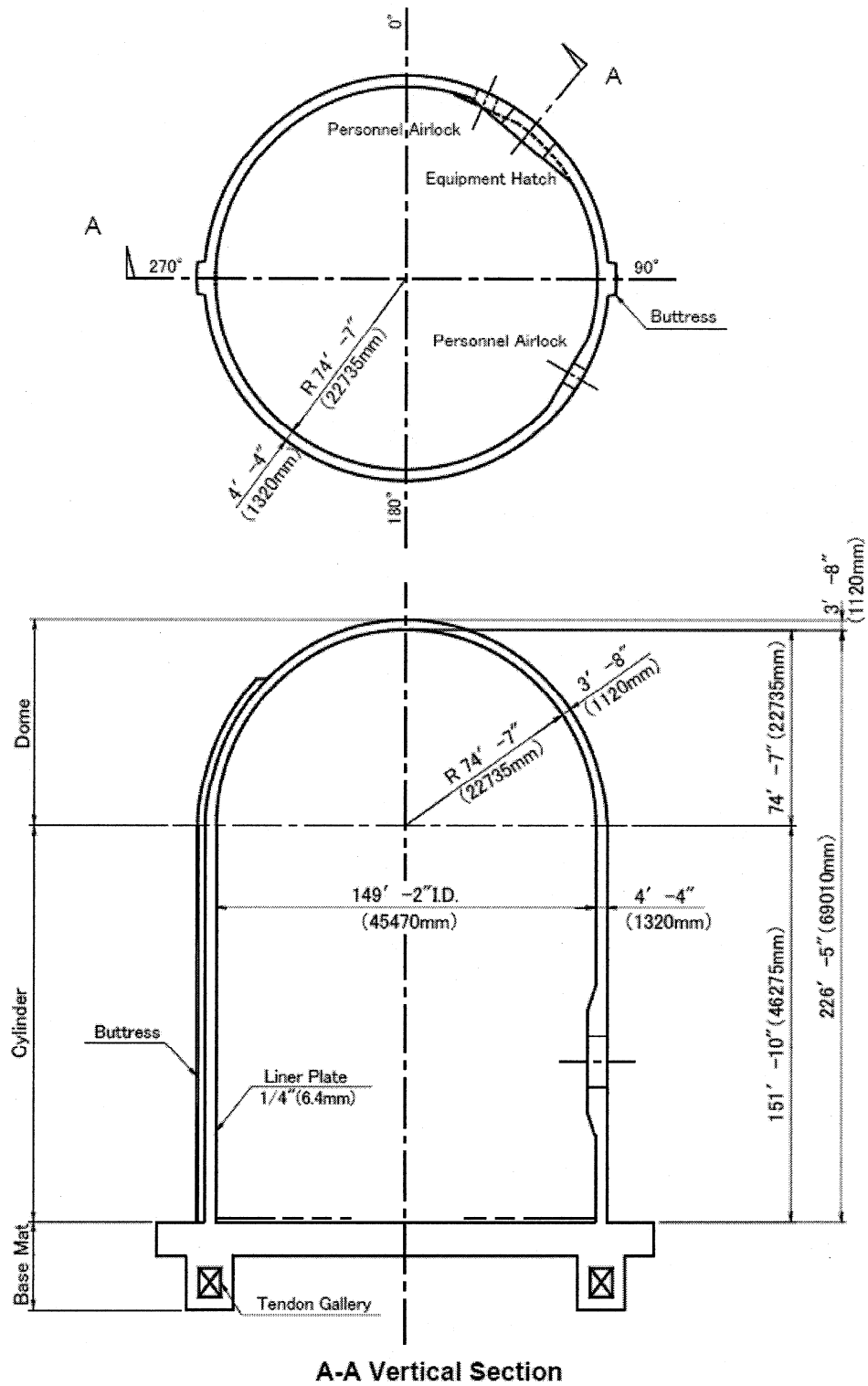

Figure 2-12 Configuration of Containment Vessel

3.0 LBLOCA CODE AND METHODOLOGY

3.1 Introduction

This chapter of the report identifies and discusses certain design features of the US-APWR, which have been approved by the NRC, in order to evaluate the applicability of the WCOBRA/TRAC code to the US-APWR. These evaluations confirm the applicability of WCOBRA/TRAC to MHI's new design, including its improved design features such as the advanced accumulator, the use of Direct Vessel Injection (DVI) for safety injection, and the Neutron Reflector's (NR) improved design.

To confirm the applicability of the WCOBRA/TRAC code to the US-APWR, the significant phenomena, especially in the components that are identified as US-APWR design features, are identified and ranked based on the existing PIRT of conventional PWRs. In particular, the applicability of the advanced accumulator (Ref.4) as a new design is confirmed by introducing a modified flow resistance model and performing model validation with a comparison between calculation results and test data.

As the results, the WCOBRA/TRAC code can be used for the purposes of performing best-estimate analyses for the US-APWR, taking into account some minor modifications. The basis for this conclusion is that for LBLOCA events, no new phenomena are identified for the US-APWR, when compared to conventional 3- and 4-loop plants, and the test database that supports validation of this code is applicable to the US-APWR.

In addition, the uncertainty evaluation method, "Realistic Large Break LOCA Evaluation Methodology Using Automated Statistical Treatment of Uncertainty Method (ASTRUM)", which has been approved can be applied to the analysis because the manner of treatment for uncertainty is very similar to conventional plants, too.

3.2 US-APWR Features

The US-APWR is a 4-loop plant with a reactor core consisting of 257 fuel assemblies of the 17x17 design. It will generate 4466 MWt, of which 4451 MWt will be generated in the reactor. Several of the US-APWR design features such as the neutron reflector (NR), model US-APWR RCP, and direct vessel injection (DVI) are improvements over prior PWR designs.

With respect to NR and DVI, the applicability of WCOBRA/TRAC to these features has already been reviewed by the NRC and has been approved in the AP600 and AP1000 designs. The Model US-APWR RCP is just a larger version of the 93A RCP used for conventional Westinghouse design PWRs. Therefore, the WCOBRA/TRAC code can incorporate the model US-APWR RCP.

The advanced accumulator is adopted for the US-APWR as a new design. This design initially delivers a sufficiently high flow rate to fill the lower plenum and downcomer, and initiate reflooding. When the water level drops below the inlet of the stand pipe, the flow rate is reduced significantly. Because it is a new design, the development of a simulated model of advanced accumulator characteristics is necessary for WCOBRA/TRAC.

3.3 Description of US-APWR LBLOCA Transient

3.3.1 General Description

The LBLOCA has been identified as a double-ended guillotine break or a split break in the cold leg pipe. This hypothesized break is a design-based accident for PWRs and is expected to produce the maximum fuel rod cladding temperature. The LBLOCA transient is subdivided into three time periods. These time periods are identified as “blowdown”, “refilling” and “reflooding”.

The design of the US-APWR is based on that of the conventional Westinghouse- designed PWRs. The ECCS configuration of the US-APWR is similar to that of the existing conventional Westinghouse-designed PWRs in which the pumped safety injection and accumulator injection are provided.

In a conventional PWR, the functions of the ECCS during a LOCA are assigned to three subsystems: the accumulator system, the Low Head Safety Injection (LHSI) system and the High Head Safety Injection (HHSI) system.

In the US-APWR, the advanced accumulator (ACC) shifts its flow rate from large flow to small flow automatically. For the high flow period the ACC performs the function of the standard accumulator in the 4-loop PWR design. For the low flow periods the ACC performs the function of LHSI beyond the time period required to quench the core. Both the accumulator function and LHSI function are combined together in the ACC to simplify the system (Ref.4).

The system configuration for the ECCS of the US-APWR is shown in Figure 3.3-1. Four ACCs are installed and each is connected to a Reactor Coolant System (RCS) cold leg. Four HHSI systems are installed and inject directly into the reactor vessel downcomer following accumulator injection flow. The US-APWR safety injection representative flow during a LBLOCA is shown in Figure 3.3-2. Therefore, the function and performance of the US-APWR safety injection systems are the same as a conventional 4-loop PWR.

Time sequences for the US-APWR LOCA transient are shown in Table 3.3-1. They are the same as for a conventional 4-loop PWR.

Figure 3.3-3 schematically shows US-APWR LOCA sequences and injection behavior of the US-APWR ECCS systems. The figure indicates the US-APWR system function is the same as a conventional 4-loop PWR.

3.3.2 Blowdown Period

The US-APWR LBLOCA blowdown starts at the location of the large break in the cold leg pipe, as the large pressure difference between the RCS and the containment forces coolant water rapidly out the broken cold leg. The break flow rate is limited by critical flow. At first, subcooled water is expelled out if the RCS pressure is high enough. Then, when the RCS pressure falls down to the saturation pressure, a two-phase mixture or steam is expelled out due to coolant flashing. The intact loop coolant begins to flash, increasing the flow resistance. The performance of the reactor coolant pumps will degrade as the coolant flashes.

The break changes from subcooled to saturated critical flow, and the break mass flow rate decreases rapidly. The mass flow from the vessel side of the break is much larger than that from the pump side because of the large flow resistances of the pump and the steam

generator tubes.

As critical heat flux is reached in the core, heat transfer changes from the nucleate boiling to the film boiling regime, and the core dries out. The fuel rod cladding temperature rises rapidly due to the degraded rod-to-coolant heat transfer.

During all phases of the LBLOCA, decay heat from the fuel, reverse heat transfer from the steam generators, and latent heat from structures are heat sources to the core. The RCS pressure falls below the secondary system pressure and reverse heat transfer occurs. Then the primary coolant is heated and vaporized by the secondary system. On the other hand, fission power reduces automatically as the fission products and actinides decay.

The RCS pressure falls below that of the nitrogen gas in the ACCs, then the check valves that normally isolate the accumulators from the RCS open, and expanding nitrogen gas forces borated water into the vessel downcomer through the intact cold legs at a large flow rate.

The water injected from the ACC continues to bypass the lower plenum. As the countercurrent steam velocity decreases, the ACC water begins to penetrate the lower plenum and refilling begins.

During blowdown, some of the water in the lower plenum boils away or is swept out by high velocity steam flow moving down through the core and up the downcomer to the broken cold leg. The amount of water remaining in the lower plenum determines the duration of the next period (refilling) of the LBLOCA.

3.3.3 Refilling Period

During refilling, the ACC refills the lower plenum immediately by large flow injection following the blowdown period. The HHSI system, consisting of low flow capacity pumps, also actuates automatically and injects emergency coolant into the vessel downcomer via the DVI nozzles.

ECC water in the reactor vessel downcomer flows down by gravity or is swept out the break point by a pressure differential and upward-escaping steam flow that levitates the liquid. This levitation is referred to as the Countercurrent Flow Limitation (CCFL) phenomenon. The reactor vessel wall and internals are large metal structures at temperatures above saturation. When subcooled ECC fluid contacts the metal structures in the downcomer, steam is generated.

The refilling period ends when the water level in the lower plenum reaches the bottom of the fuel rods.

3.3.4 Reflooding Period

Reflooding begins when the lower plenum is completely filled with ECC water. The core begins to reflood with ECC water after the lower plenum is filled.

During the reflooding period, the ACC refills the downcomer immediately by large flow injection, and establishes the core reflooding condition by maintaining the downcomer water level. A small flow injection can maintain core cooling after refilling condition.

The primary source of ECC water for reflooding is the small flow of the ACCs injected into the

cold legs, and the secondary source is the HHSIs. The ACC flow rate switches from large flow to small flow automatically when the water level in the ACC tank reaches the inlet of the standpipe.

At the beginning of the reflooding period, the fuel rods are relatively hot because the rod-to-coolant heat transfer has not been very effective during most of the blowdown and all of the bypass/refilling period. Because of high fuel rod temperatures at the beginning of reflooding, the flow regimes in the core during reflooding should change the conditions, starting with single-phase liquid and progressing upward through the core with nucleate boiling, transition boiling, film boiling, churn two-phase flow, dispersed droplet flow, and single-phase steam flow. When water firstly covers the bottom of the fuel rods, the fuel cladding surface is not wetted because film boiling is the main heat transfer mechanism. Eventually, the fuel cladding temperature falls below the minimum film boiling temperature, and the liquid wets the fuel cladding surface and cools it. The fuel cladding temperature at that elevation drops down sharply to nearly the coolant saturation temperature, that is, the rods are quenched. Quenching progresses from the bottom to the top as the core is reflooded. Some top-quenching also occurs in addition to bottom-quenching at the same time, as explained below.

The quenching process releases a large amount of heat to the reflooding water and steam is generated. The generated steam carries water droplets upward as it rises between the fuel rods. These entrained droplets help to cool the rods at higher elevations. As the bottom quenching progresses upward through the core, more liquid is carried over to the upper plenum pool and the level of the two-phase mixture can reach the hot leg. At first, water from the pool cannot flow down to cool the rods because the generated steam is flowing upward through the holes in the upper core support plate. This phenomenon is similar to that occurring in the downcomer during bypass. At some point, however, water films penetrate the holes and begin to quench the fuel rods from the top. Top-down quenching by falling films takes place first at the core periphery where decay heat is the lowest.

If liquid carried through the hot legs reaches the steam generators, it will be vaporized by reverse heat transfer from the steam generator, causing a pressure increase in the upper plenum. The pressure increase reduces the reflooding rate, giving rise to a steam binding effect. The core vapor mass flow rate decreases alongside the decreasing quench velocity, and this reduces the amount of liquid entrained and carried over to the hot legs. The upper plenum pressure decreases, causing an increase in flooding rates. This cyclical process may be repeated, at a decreasing rate, until the entire core is reflooded.

Table 3.3-1 Typical Sequence of the LBLOCA of US-APWR

Period	Summary of LBLOCA Transient
<p>Blowdown</p> <p>Refilling</p> <p>Reflooding</p>	<p>Cold leg break occurs</p> <p>The containment high pressure "S" signal generated</p> <p>Fuel cladding temperature reaches its peak (in the blowdown peak cladding temperature(PCT) case)</p> <p>Start of accumulator injection</p> <p>Start of core-reflooding</p> <p>Accumulator injection flow rate switches to small</p> <p>Start of HHSI to vessel directly *</p> <p>(Fuel cladding temperature reaches its peak in the reflooding PCT case)</p> <p>Core temperatures are reduced to long-term steady state levels associated with dissipation of residual heat generation</p> <p>Continued operation of the HHSI supplies water during long-term cooling</p>

*Loss of offsite power is assumed.

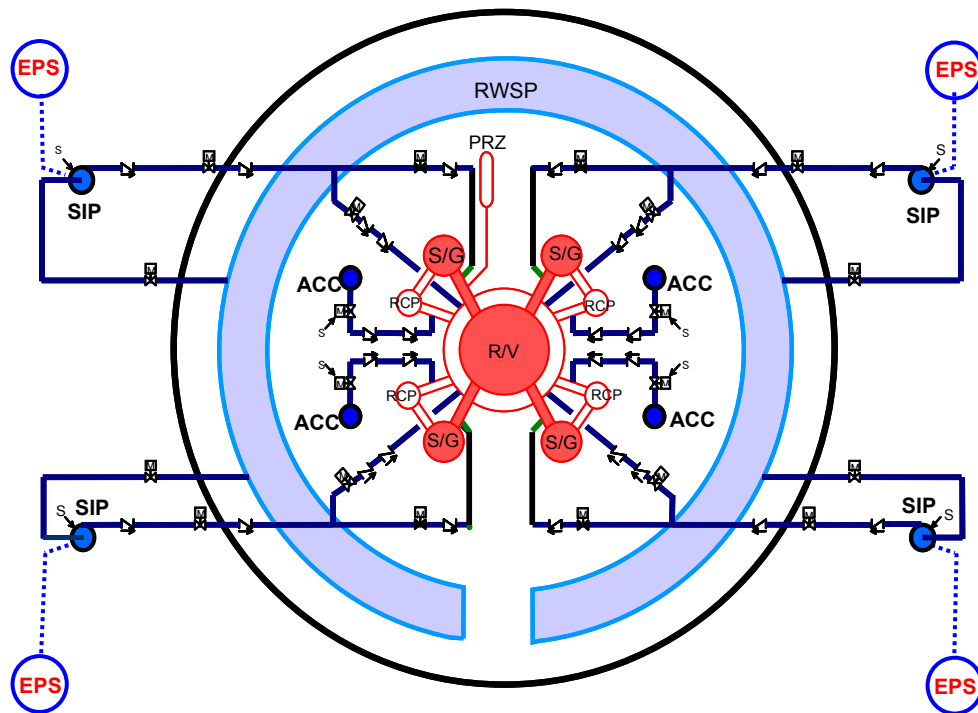

Figure 3.3-1 System Configuration of ECCS of US-APWR

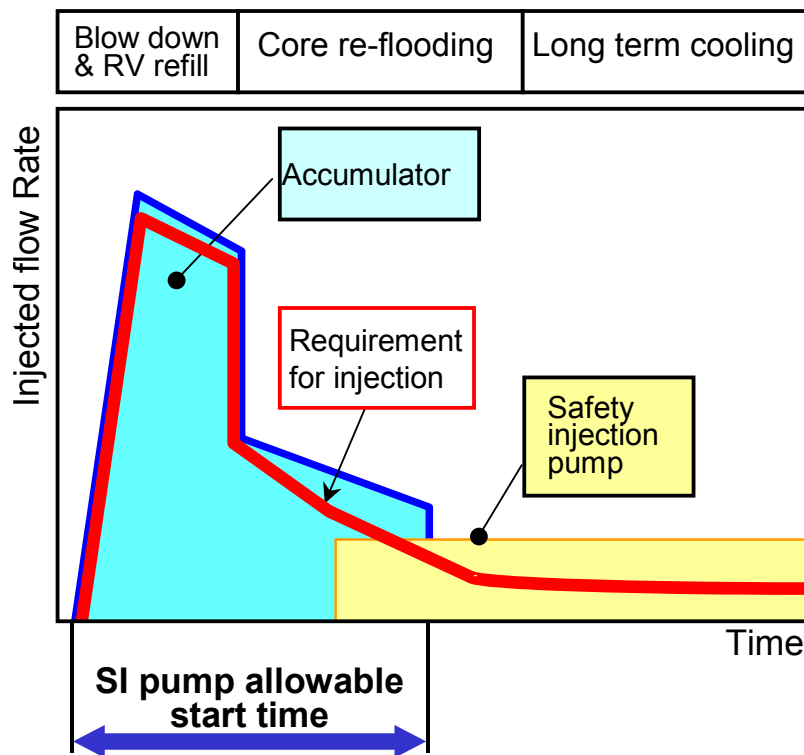

Figure 3.3-2 ECCS Flow Injection Performance during LBLOCA

Steam Generator

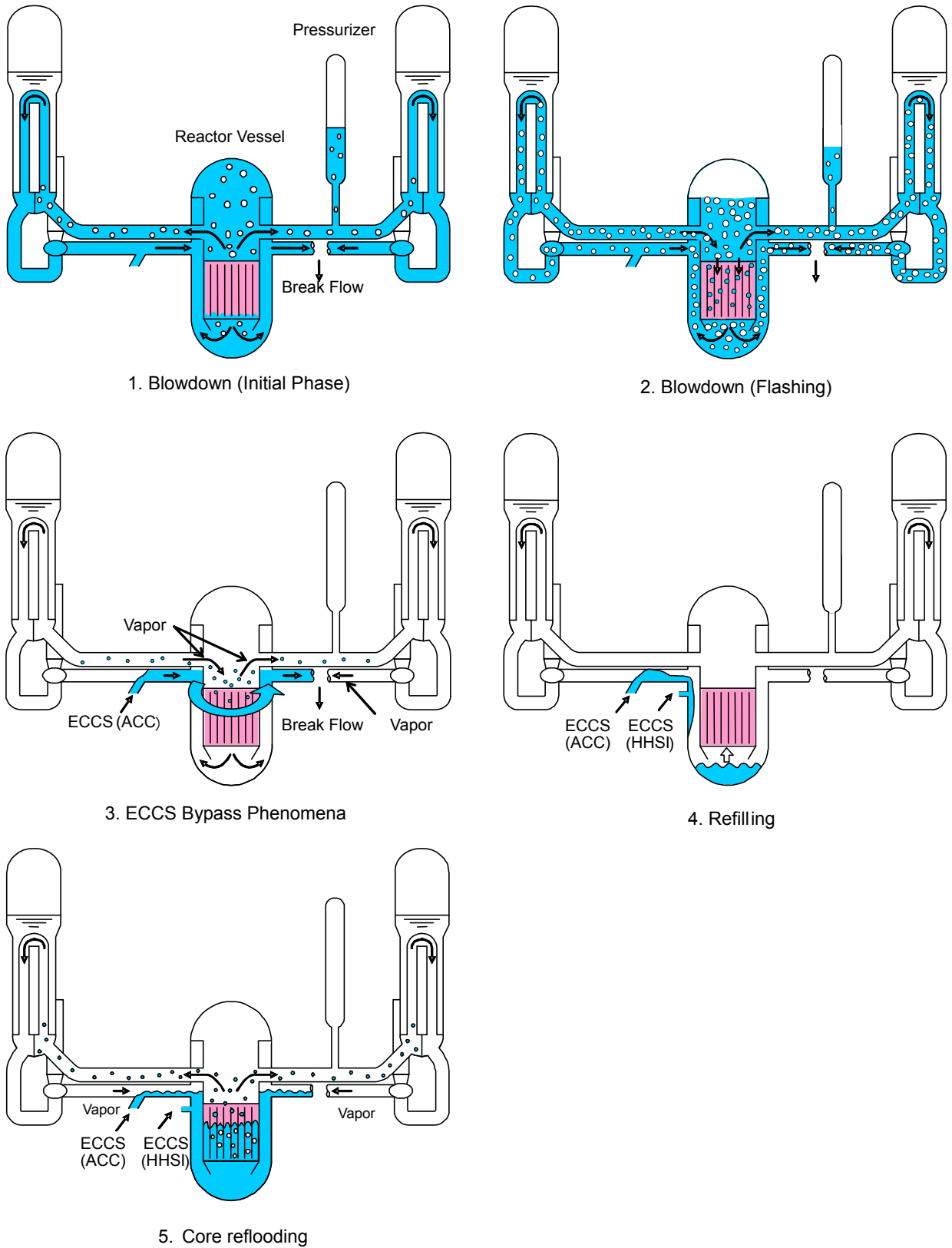

Figure 3.3-3 Transient of LBLOCA in US-APWR

3.4 Phenomena Identification and Ranking (PIRT)

3.4.1 LBLOCA PIRT

In this section, the modeling requirements for performing a LBLOCA best-estimate calculation for the US-AWR are identified and discussed. In developing the requirements, the individual phenomena and processes that must be modeled to achieve an accurate estimate of the Peak Cladding Temperature (PCT) are identified as well for a conventional 4-loop plant.

A Phenomena Identification and Ranking Table (PIRT) for the US-APWR is developed, using the same process that is described in the Westinghouse PIRT (Ref.5) for a conventional 4-loop plant. The following highly ranked models and phenomena are identified from the PIRT as well.

- a) Critical flow
- b) Broken loop resistance
- c) Fuel rod (fuel conductivity, gap conductivity, rod internal pressure, decay heat, cladding swelling and burst, ZIRLO™ -water reaction, and fuel relocation)
- d) Core heat transfer
- e) ECC bypass
- f) Entrainment/Steam binding
- g) Accumulator nitrogen
- h) Condensation

The PIRT for all operating conventional plant designs (3- and 4-loop plants with cold leg ECCS injection) (Ref.6) and the US-APWR is provided in Table 3.4-1. The development of the US-APWR PIRT was established based on the existing PIRT in which Westinghouse ranked and identified phenomena as a starting point, and included additional information relevant to the US-APWR specific features. In this table, the conventional 3- and 4-loop plants with cold leg injection are treated as a single group.

In the ranking of importance of the thermal hydraulic phenomena, Westinghouse did not rank any phenomena with a ranking less than "5". This ranking should not be interpreted to mean that those phenomena that were not ranked can be ignored or do not have to be simulated.

The existing PIRT and the US-APWR PIRT are presented using the same format from the Code Scaling, Applicability and Uncertainty (CSAU) evaluation, with the CSAU ranking as a comparison guide. Conventional PWR and MHI's US-APWR also retained the same definition of the LOCA periods as identified in the CSAU PIRT. The blowdown phase of the accident extends from the accident initiation to the initiation of the accumulator injection into the intact loops (approximately 600 psia in Westinghouse 3- and 4-loop plants). Refilling is assumed to begin when the lower plenum is refilled. Reflooding continues from the bottom of the core recovery and continues until the PCT has occurred and the cladding is cooling down. These definitions are different from the traditional definitions for the blowdown and refilling periods (refilling usually begins when ECC bypass ends).

Instead of "numerical values", three ranking levels are applied to each phenomenon in the US-APWR PIRT. The rankings are assigned using the following definitions (Ref.7).

H = The process is considered to have high importance. Accurate modeling of the

process is considered to be crucial to the correct prediction of the transient. Models used to predict the process must be validated. (Ranked 7-9) (More than [] sensitivity)

M = The process is considered to have medium importance. Modeling has to be done for appropriate process simulation, although the level of influence of the process on the entire transient is expected to be lower than that for those ranked high. (Ranked 5-6) (More than [] sensitivity)

L = The process is considered to have low importance. The phenomena need to be modeled in the code or explained in adequate detail in the methodology, although accuracy in modeling the process is not considered very influential on the whole transient.

N/A = The process is considered not to occur at all.

The rankings of the various processes in terms of importance were confirmed by five thermal-hydraulic analysts and engineers at MHI. A meeting was held in June 2007 to establish the PIRT for an LBLOCA in the US-APWR.

3.4.1.1 Fuel Rod

3.4.1.2 Core

3.4.1.3 Upper Plenum

3.4.1.4 Hot Leg

3.4.1.5 Pressurizer

3.4.1.6 Steam Generators

3.4.1.7 Pump

3.4.1.8 Cold Leg/Accumulator



3.4.1.9 Downcomer





3.4.1.10 Lower Plenum



3.4.1.11 Break

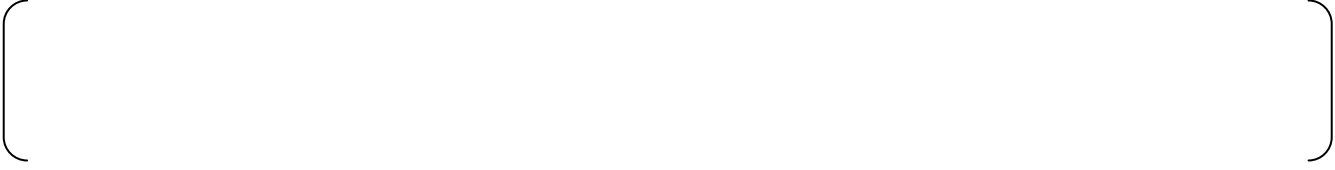



3.4.1.12 Loop



3.4.2 Effects of US-APWR Design on Westinghouse PIRT Conclusions



3.4.2.1 Advanced Accumulator





3.4.2.2 Direct Vessel Injection (DVI)



3.4.2.3 Neutron Reflector (NR)



Table 3.4-1 US-APWR PIRT (1/2)

Table 3.4-1 US-APWR PIRT (2/2)

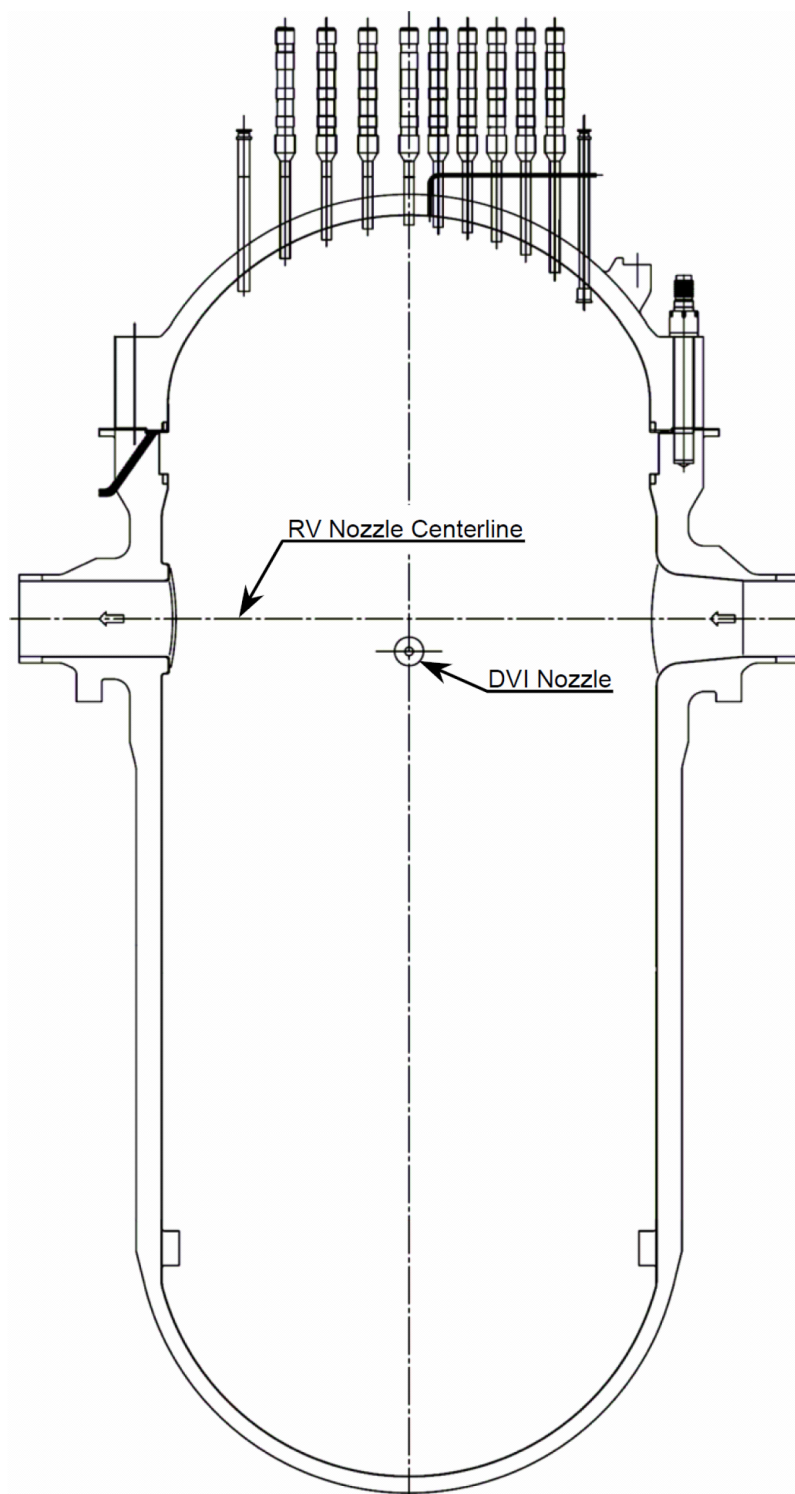

Figure 3.4-1 Location of Direct Vessel Injection Nozzle

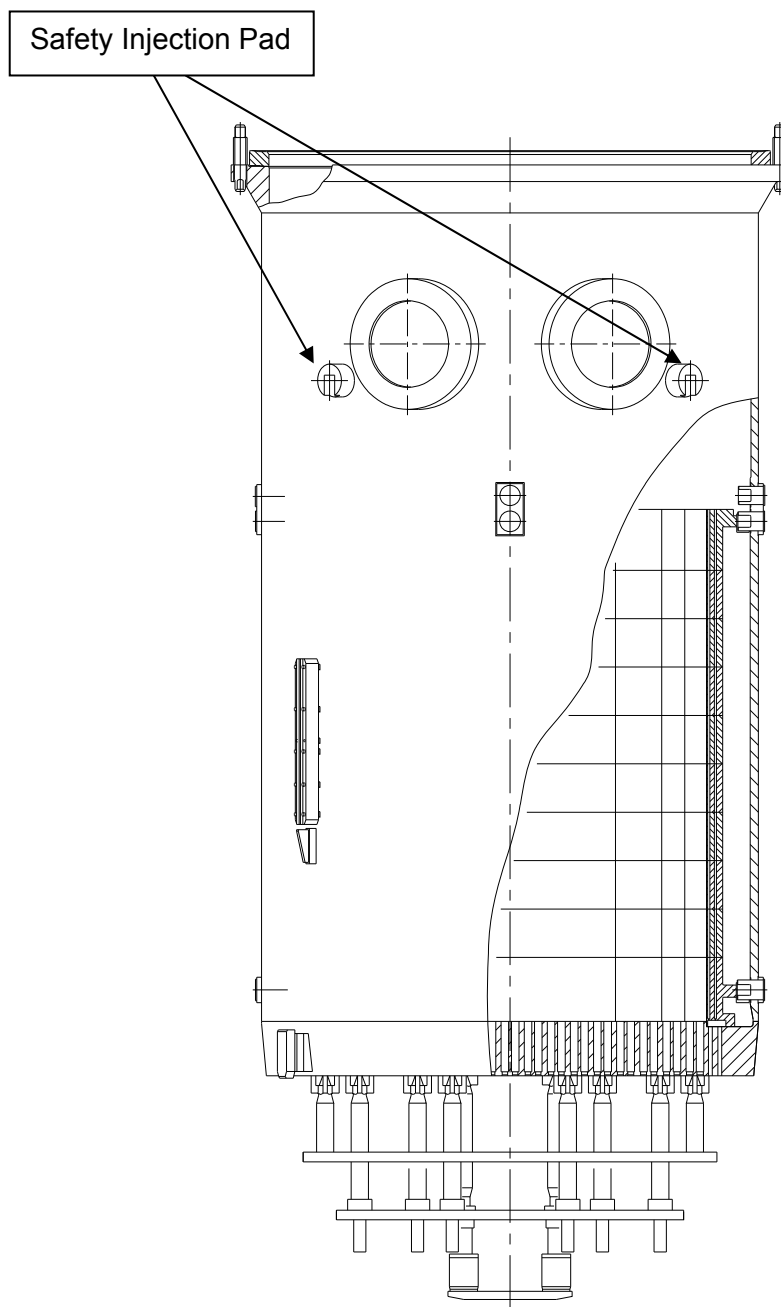

Figure 3.4-2 Safety Injection Pad of Direct Vessel Injection

3.5 WCOBRA/TRAC Code Applicability to US-APWR

3.5.1 Advanced Accumulator

3.5.1.1 Code Applicability

The ACC is a water storage tank with a flow damper in it that switches the flow rate of the cooling water injected into the reactor vessel from a large to a small flow rate. A simplified drawing of the ACC is shown in Figure 3.5-1.

There is a vortex chamber at the inlet of the injection pipe in the accumulator tank. The small flow rate pipe is tangentially attached to the vortex chamber. The large flow rate pipe is radially attached to the vortex chamber on one end and connected to the standpipe on the other end. The inlet port for the stand pipe is located on the level of the interface between the volume of water for the large flow rate injection and that for the small flow rate injection in the tank. The outlet port of the flow damper is connected to the injection pipe. The ACC is thus a simple device with no moving parts.

The accumulator is a pressure vessel partially filled with water and pressurized with nitrogen gas (N₂). The accumulator is isolated from the Reactor Coolant System (RCS) by two check valves. When a LOCA occurs and pressure in the reactor vessel decreases, the check valves in the injection pipe open to permit the injection of cooling water into the vessel. Since the water level in the accumulator tank is at first higher than the elevation of the inlet of the stand pipe, water flows through both the large and small flow rate pipes. The pressure at the throat is comparatively lower than that at the injection pipe during large flow rate. If the pressure at the throat drops below the critical pressure of cavitation inception, cavitation may occur. As a result of tests, a cavitation factor has been introduced to simulate the flow rate characteristics.

High flow continues until the water level in the accumulator tank comes down to the inlet level of the stand pipe. The flow in the large flow rate pipe almost comes to a stop then, and the flow from the small flow rate pipe forms a strong vortex in the vortex chamber. As a result of centripetal force, a large pressure drop occurs along the radius of the vortex chamber between the small flow rate pipe and the output port. Therefore, a small flow rate is achieved as a result of the vortex, rather than with moving parts. This flow continues until the accumulator is empty, after which the nitrogen cover gas is discharged.

Therefore, the injection flow characteristics in the ACC with regards to the following items should be simulated by WCOBRA/TRAC.

- Flow resistance change due to cavitation characteristics. A cavitation equation as an empirical correlation has been obtained by testing (Ref.4).
- Sudden switching from high flow rate to low flow rate due to the existence of a stand pipe.

Injection Flow Rate

WCOBRA/TRAC does not model flow resistance change due to cavitation factor and flow switching caused by the stand pipe because the conventional ACC does not control those flows. The existing flow resistance model of the code is only a constant value given by the input and friction correlation, and the model has no water level-dependant flow resistance. Therefore, flow resistance change and flow switching must be revised in the code by using empirical correlations (Ref.4), and any switching of the equation depends on water level or residual water volume in the ACC, respectively.

Discharge of N₂ Gas

WCOBRA/TRAC already has a model for the discharge of N₂ gas after the emptying of water as the discharge gas is simulated by subcooled vapor, which is approved by the NRC.

Consequently, the model that should be revised in WCOBRA/TRAC was clarified, and the empirical correlations are incorporated into the WCOBRA/TRAC code to model advanced accumulator characteristics.

3.5.1.2 Model Revisions

The revised WCOBRA/TRAC code with the advanced accumulator model is named WCOBRA/TRAC(M1.0).

The total resistance coefficient, K_{ACC} , is determined from the ACC flow rate coefficient, C_v , and the resistance coefficient from the injection piping. The flow rate coefficient is a function of the cavitation factor, σ_v , and the water level in the ACC. The total resistance coefficient is calculated each time step as follows.

(1) σ_v is calculated from the flow condition at flow damper

$$\sigma_v = \frac{P_D + P_{at} - P_v}{(P_A + \rho g H) - \left(P_D + \frac{\rho V_D^2}{2} + \rho g H' \right)} \quad (3.5.1-1)$$

- σ_v : Cavitation factor
- P_{at} : Atmospheric pressure (abs)
- P_D : Flow damper outlet pressure (gage)
- P_A : Gas pressure in accumulator (gage)
- P_v : Vapor pressure (abs)
- ρ : Density of water
- g : Acceleration of gravity
- H : Distance between ACC water level and vortex chamber
- H' : Distance between outlet pipe and vortex chamber
- V_D : Velocity of injection pipe

(2) The flow rate coefficient C_v is calculated using the following correlations obtained from test

data that covers the range of applicability for the US-APWR design (Ref.4). The empirical correlations of C_v are derived separately for large and small flow rate injections as a function of the cavitation factor of σ_v as shown in Figure 3.5-2.

$$\text{For large flow rate: } C_v = 0.7787 - 0.6889 \exp(-0.5238 \sigma_v) \quad (3.5.1-2)$$

$$\text{For small flow rate: } C_v = 0.07197 - 0.01904 \exp(-6.818 \sigma_v) \quad (3.5.1-3)$$

(3) C_v is converted to K_D

$$K_D = 1/C_v^2 \quad (3.5.1-4)$$

K_D : Flow resistance coefficient of flow damper

(4) Total resistance coefficient is calculated by;

$$K_{acc} = K_D + K_{pipe} \quad (3.5.1-5)$$

K_{acc} : Total resistance coefficient of flow damper and injection piping

K_{pipe} : Total resistance coefficient of injection piping

Since subroutines ACCUM1 and ACCM1X calculate flow resistance and residual water volume, respectively, these subroutines were revised to incorporate the correlations. The advanced accumulator model as coded is described in Appendix B.

3.5.1.3 Model Validation

Analyses for actual pressure and full height 1/2 scale tests were performed to validate the revised model. The purpose of the analyses was to confirm that the analytical results were in a good agreement with test data.

(1) Summary of test facility description



(2) Test cases and test conditions

The validation analysis was performed subject to full height 1/2 scale test (Ref.4), which includes the test cases to simulate the ECCS performance during a LBLOCA. Only the following three cases of all test cases simulate the range of initial tank pressure and RCS pressure conditions during a LBLOCA. The ACC tank gas pressure and the exhaust tank pressure corresponding to RCS pressure are shown in Table 3.5-2.

- Case 1: The initial test tank pressure was 586 psig (4.04 MPa (gage)) simulating the condition for ECCS performance during a LBLOCA.

- Case 2: The initial test tank pressure was 657 psig (4.53 MPa (gage)) to obtain data for high pressure design.
- Case 3: The initial tank pressure was 758 psig (5.23 MPa (gage)) to obtain data for large differential pressure design.
- The pressure in the exhaust tank was 14 psig (0.098 MPa (gage)) for Cases 1, 2, and 3. Since the pressure of the exhaust tank becomes the same as the pressure of the containment vessel (CV) after the blowdown phase during a LBLOCA, and ECCS performance analysis uses approximately 14 psig (0.098 MPa (gage)) and the backpressure was set at 14 psig (0.098 MPa (gage)).

(3) Analytical model and boundary conditions for test analyses

The analytical model of the advanced accumulator is shown in Figure 3.5-5. The model is based on the nodalization described in Appendix B including the standard nodalization schemes such as node length, flow area and volume.

(4) Analysis conditions

Analysis conditions for full height 1/2 scale test are shown in Table 3.5-3 based on test condition shown in Table 3.5-2.

The input data including the analytical model, boundary conditions and the analysis conditions are prepared in the same method as plant analysis.

(5) Analysis results and comparison with test data

Analysis results are shown in Figure 3.5-7 to Figure 3.5-9. Analysis results are in good agreement with test data, especially for integrated injection flow rate, which is the most important for reflooding PCT until there is enough time to validate the advanced accumulator modeling.

Consequently, it is confirmed that the ACC modeling by the revised code "WCOBRA/TRAC(M1.0)" is valid for the simulation of ACC injection flow rate in the US-APWR safety analysis.

3.5.1.4 Uncertainty

The advanced accumulator has two kinds of uncertainties: one is an empirical correlation of Equation 3.5.1-2 and 3.5.1-3, and the other relates to flow switching water level. These uncertainties are evaluated to determine how it is treated for the LOCA safety analysis.

(1) Uncertainty of the Characteristic Equations for Flow Rates



Instrument Uncertainties



Dispersion Deviation from Experimental Equations

Manufacturing Error

Total Uncertainty of Experimental Equation Applicable to US-APWR

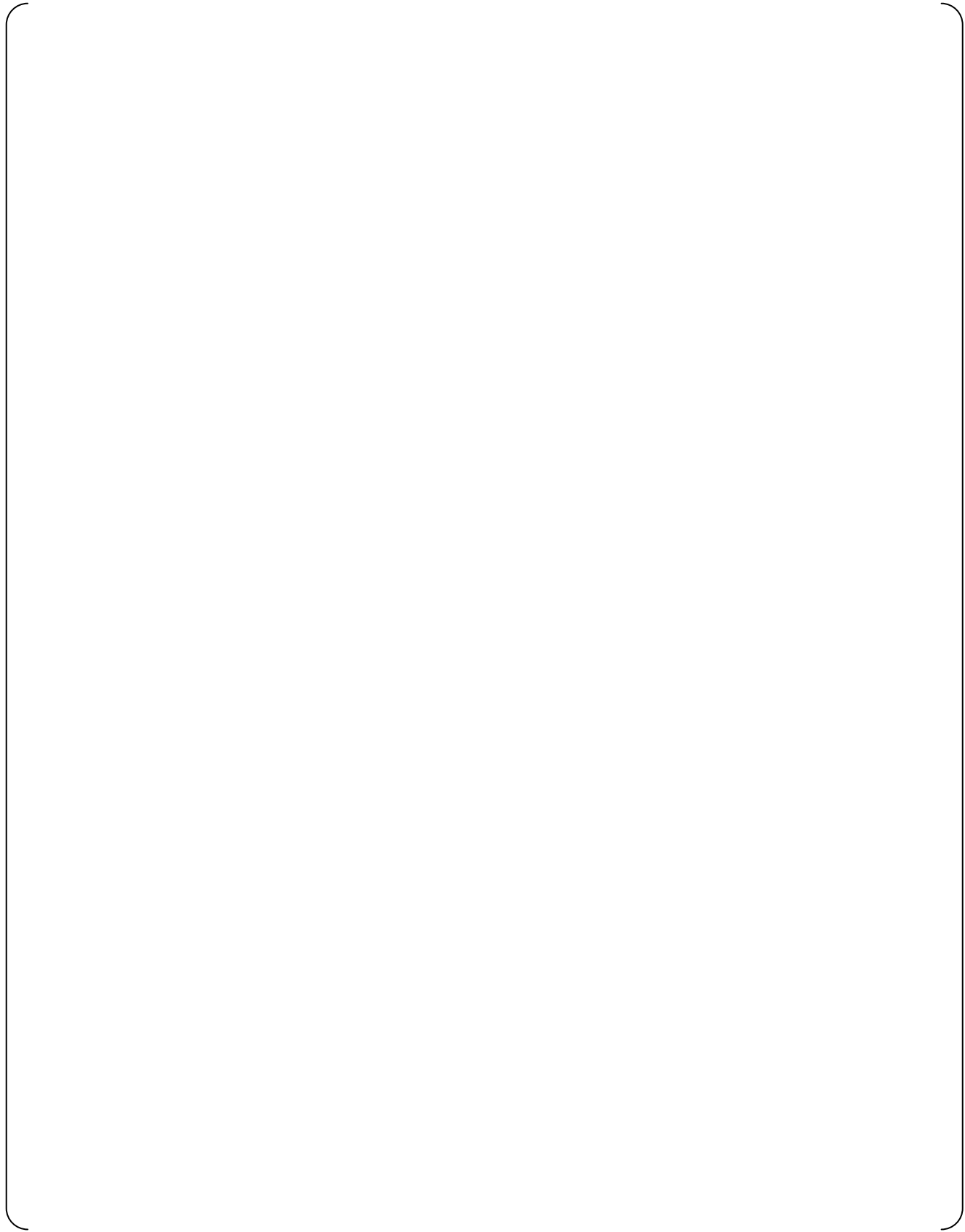

The total uncertainty of empirical equations used for safety analysis of a LBLOCA on the US-APWR including the instrument uncertainties, the data dispersion and manufacturing error is treated as statistical parameter in ASTRUM.

(2) Uncertainties of Water Level for Switching Flow Rates for US-APWR**(3) Treatment of Dissolved Nitrogen Gas Effect****3.5.1.5 Summary**

The model that should be revised in WCOBRA/TRAC was clarified through the code applicability investigation, and the empirical correlations of the flow damper in the advanced ACC were incorporated into the WCOBRA/TRAC code to model ACC characteristics.

The methodology to calculate flow damper characteristics including empirical correlation was described on a model basis and coded in WCOBRA/TRAC.

The WCOBRA/TRAC code, which is modified slightly, is called WCOBRA/TRAC(M1.0) in this report.

Analyses for full height 1/2 scale tests on actual pressure were performed to validate the model of WCOBRA/TRAC with the revised model concerning the flow damper. As a result of comparison with analysis and test data, it has been confirmed that the revised WCOBRA/TRAC code (WCOBRA/TRAC(M1.0)) is in good agreement with test data. In addition, it has already been confirmed that there is no scaling effect between ACC tests and the US-APWR (Ref.4). Therefore, the code is validated and has the capability of NPP simulation with water injection characteristics of the ACC.

The total uncertainty of flow damper flow resistance and flow switching used for safety analysis of a LBLOCA on the US-APWR is derived from the full height 1/2 scale test data.

The treatment for uncertainties of flow damper resistance and flow switching for the US-APWR safety analysis using the ASTRUM methodology are determined as statistical parameters.

Table 3.5-1 Phenomena/Model in WCOBRA/TRAC for ACC

A large, empty rectangular frame with rounded corners, intended for the content of Table 3.5-1. The frame is currently blank.

Table 3.5-2 Test Conditions of Full Height 1/2 Scale Test

	Test Tank Pressure	Exhaust Tank Pressure	Objective
	psig (MPa gage)	psig (MPa gage)	
Case 1	586 (4.04)	14 (0.098)	Obtain flow characteristics for ECCS performance evaluation during a LBLOCA
Case 2	657 (4.53)	14 (0.098)	Obtain flow characteristics for high pressure design
Case 3	758 (5.23)	14 (0.098)	Obtain flow characteristics for large differential pressure

Table 3.5-3 Analysis Conditions

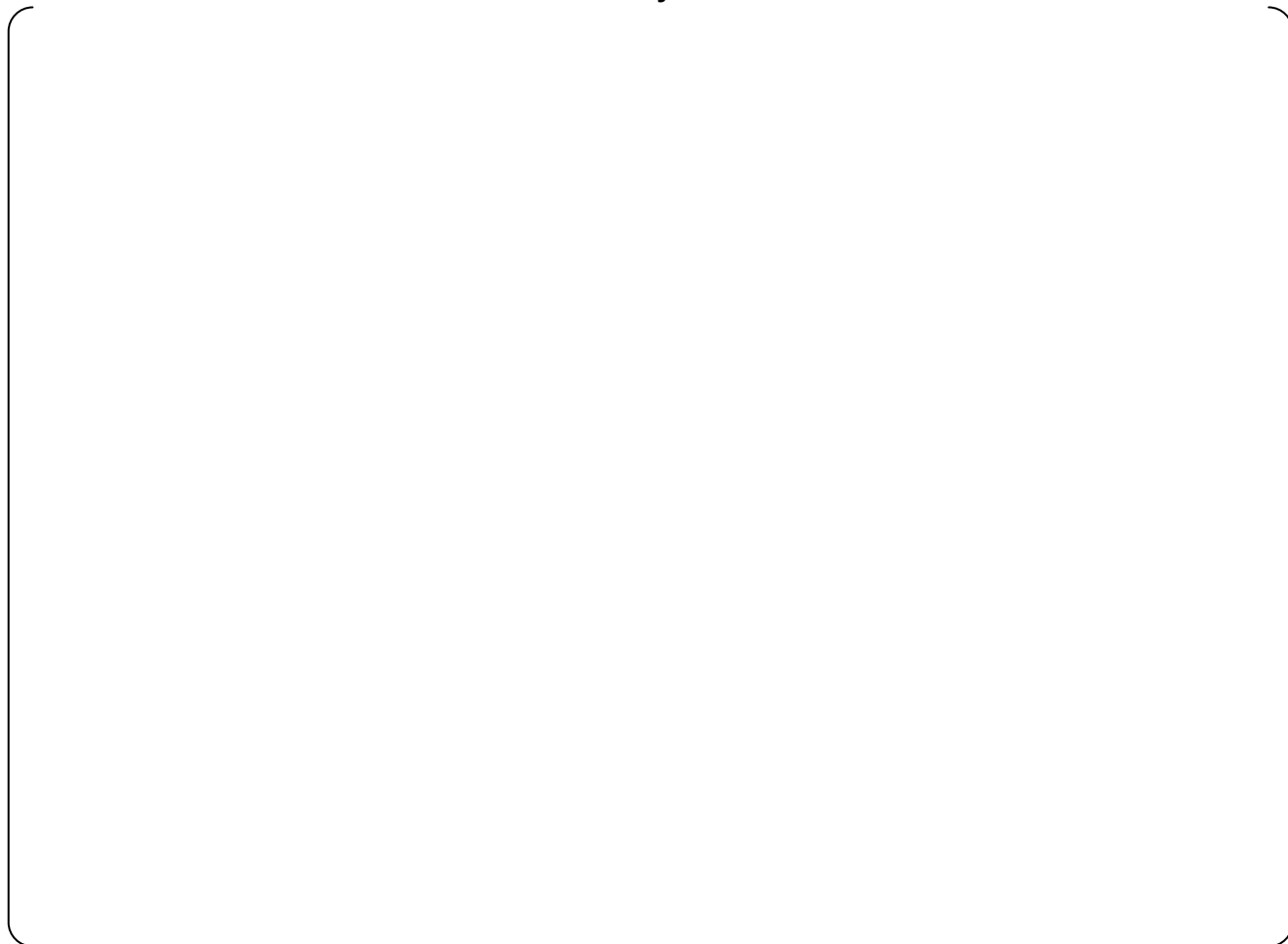

Table 3.5-4 Instrument Uncertainties (1/2) (Large Flow)

A large, empty rectangular frame with rounded corners, intended for the content of Table 3.5-4 (1/2).

Table 3.5-4 Instrument Uncertainties (2/2) (Small Flow)

A large, empty rectangular frame with rounded corners, intended for the content of Table 3.5-4 (2/2).

Table 3.5-5 Dispersion of Data from Experimental Equation

An empty rectangular frame with rounded corners, intended for the content of Table 3.5-5.

Table 3.5-6 Total Uncertainty of Flow Rate Coefficient (Experimental Equations) for Safety Analysis of US-APWR



Table 3.5-7 Additional Bias to Flow Rate Coefficient (Experimental Equations)



Table 3.5-8 Uncertainty of Water Level for Switching Flow Rates



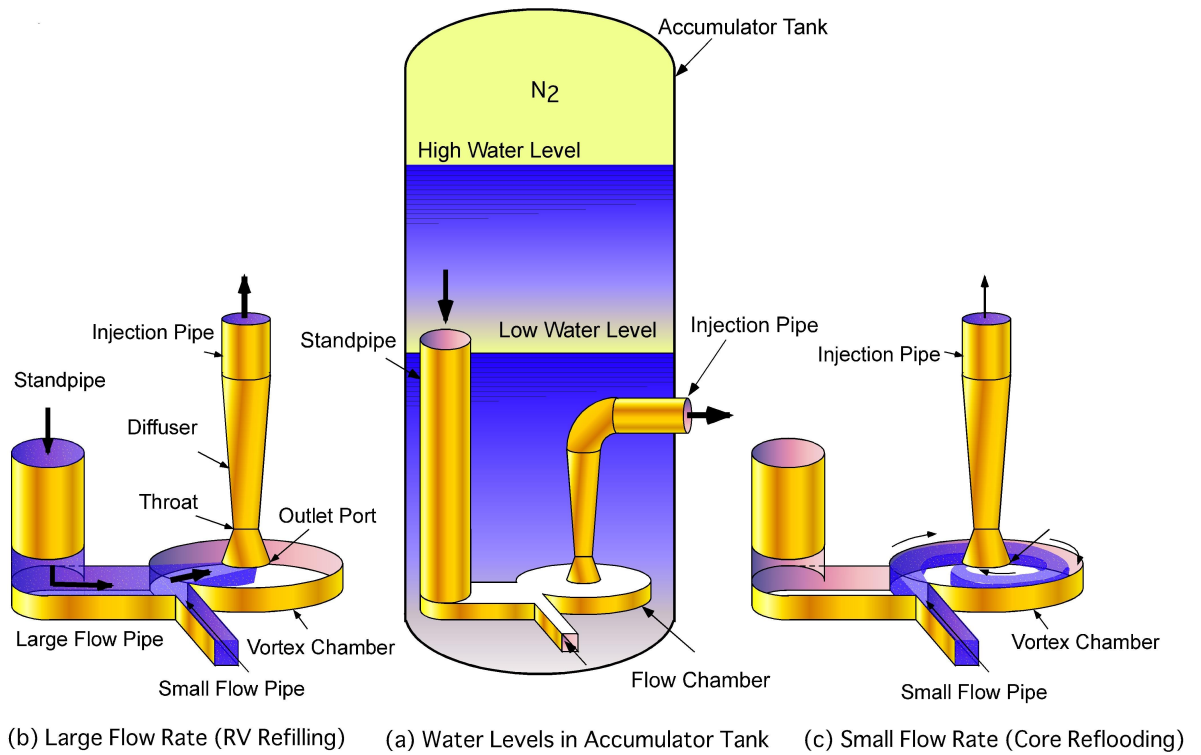

Figure 3.5-1 Principle of Advanced Accumulator



Figure 3.5-2 Flow Characteristics of Flow Damper

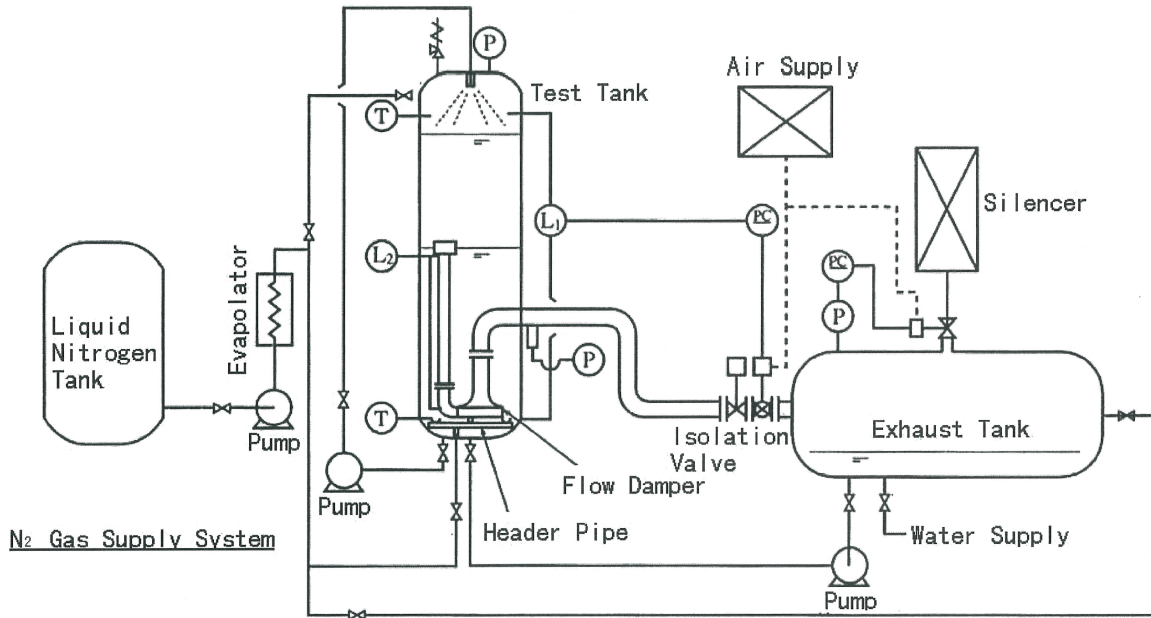

Figure 3.5-3 Schematic Drawing of Full Height 1/2 Scale Test Facility



Figure 3.5-4 Outline Drawing of Full Height 1/2 Scale Test Facility

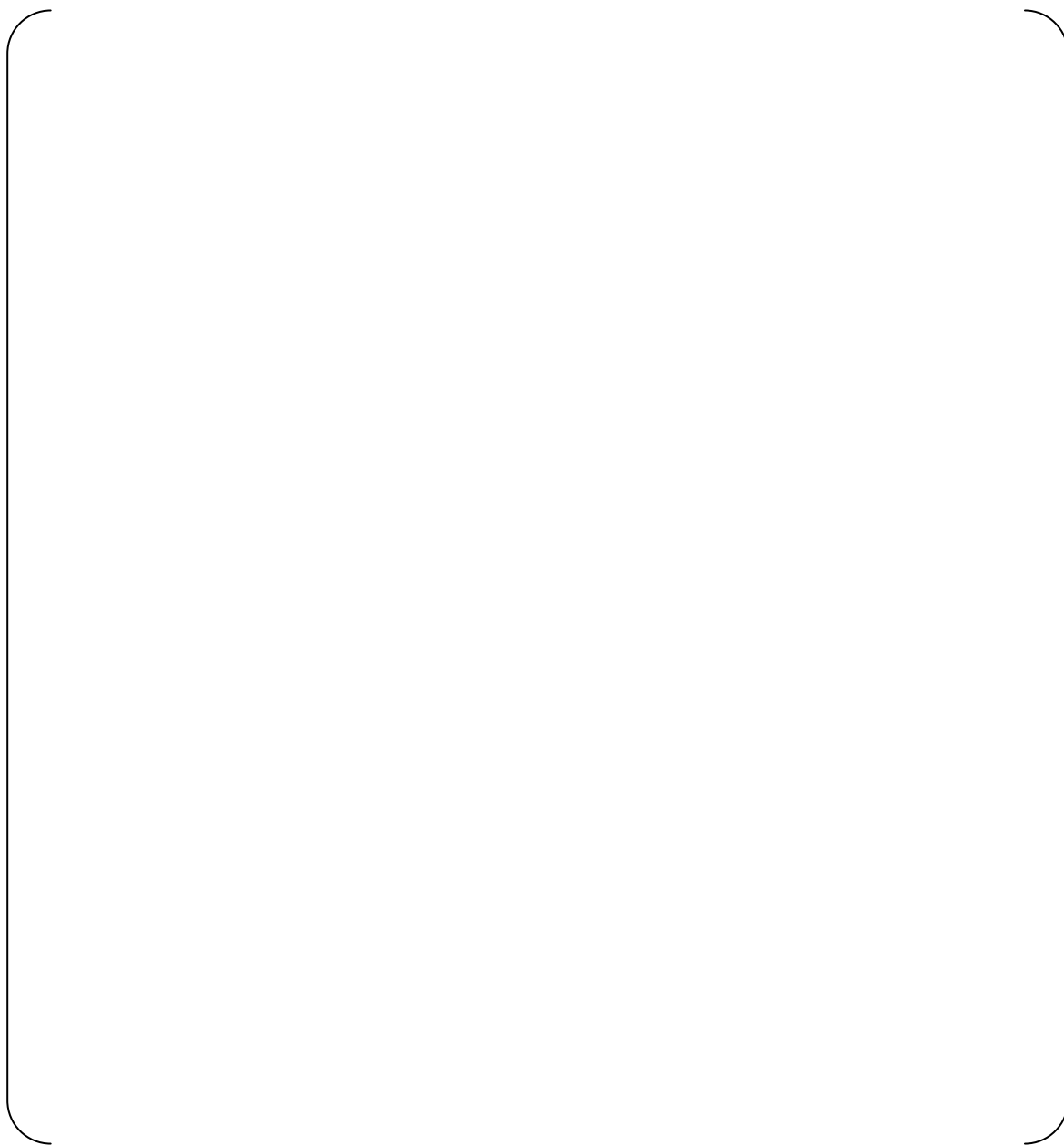

Figure 3.5-5 Nodalization of Full Height 1/2 Scale ACC Test Section



Figure 3.5-6 Flow Damper Outlet Pressure Given at BREAK (Case 1)



**Figure 3.5-7 (1/3) Comparison between Test and Analysis of Flow Rate
(Full Height 1/2 Scale Test Case 1)**

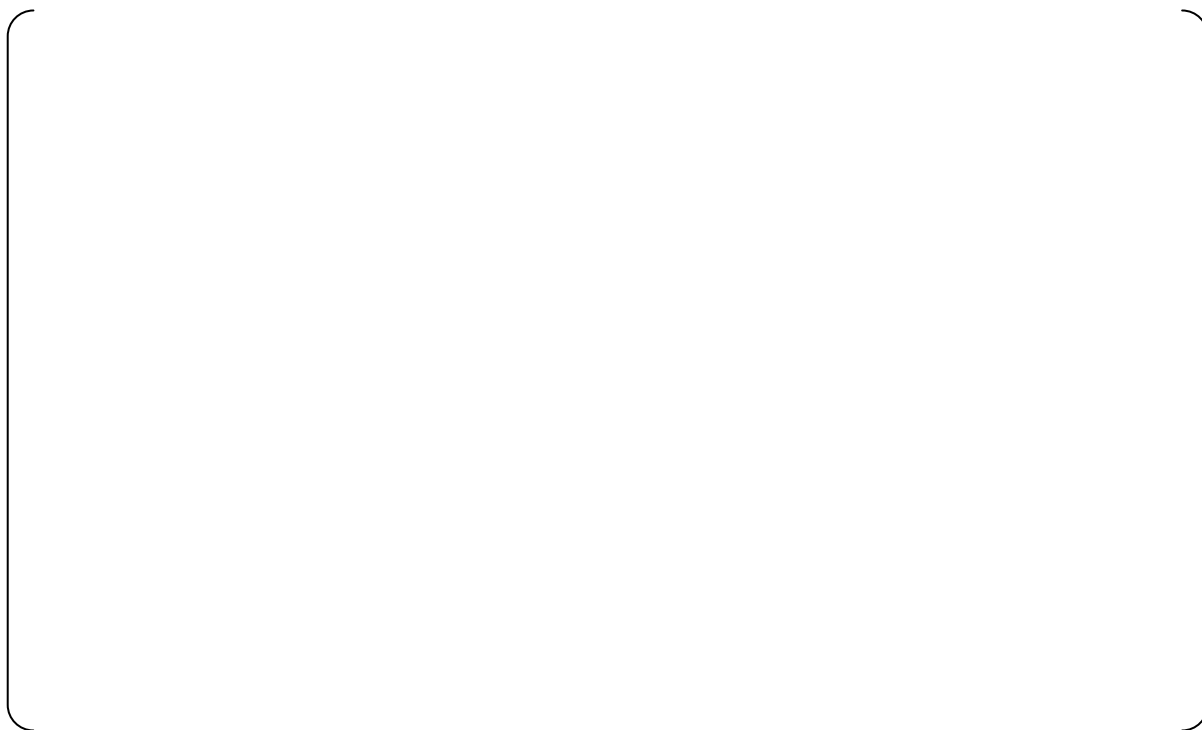

**Figure 3.5-7 (2/3) Comparison between Test and Analysis of Integrated Flow Rate
(Full Height 1/2 Scale Test Case 1)**



Figure 3.5-7 (3/3) Comparison between Test and Analysis of Gas Pressure in Test Tank (Full Height 1/2 Scale Test Case 1)



Figure 3.5-8 (1/3) Comparison between Test and Analysis of Flow Rate (Full Height 1/2 Scale Test Case 2)



Figure 3.5-8 (2/3) Comparison between Test and Analysis of Integrated Flow Rate (Full Height 1/2 Scale Test Case 2)



Figure 3.5-8 (3/3) Comparison between Test and Analysis of Gas Pressure in Test Tank (Full Height 1/2 Scale Test Case 2)



**Figure 3.5-9 (1/3) Comparison between Test and Analysis of Flow Rate
(Full Height 1/2 Scale Test Case 3)**



**Figure 3.5-9 (2/3) Comparison between Test and Analysis of Integrated Flow Rate
(Full Height 1/2 Scale Test Case 3)**



Figure 3.5-9 (3/3) Comparison between Test and Analysis of Gas Pressure in Test Tank (Full Height 1/2 Scale Test Case 3)

3.5.2 Direct Vessel Injection (DVI)

The applicability of WCOBRA/TRAC to DVI was reviewed and approved by the NRC for the AP600 (Ref.2) and AP1000 (Ref.3) designs.

Therefore, no modifications to treat the uncertainty of the DVI model are unnecessary for the US-APWR.

3.5.3 Neutron Reflector

As discussed in section 3.4.2.2, it is concluded that the PIRT ranking of the thermal hydraulic phenomenon in the NR of the US-APWR is "Medium" during reflooding period.

The NR weighs more than [] lbm and adds mass adjacent to the core region. The steam generation and entrainment from its cooling holes may potentially have an impact on the reflooding heat transfer in the core and the ultimate peak cladding temperature.

Liquid flow into the NR would result in additional steam generation, which may retard the quench front and progress in the core in the same manner as the steam binding effect from the vapor generation in the steam generators. At the same time, since the flow path of the NR and the core channels form parallel paths between the lower plenum and the CCFL region below the upper core plate, the liquid flow into the NR may divert the core flow for cooling.

3.5.3.1 Thermal Hydraulic Behavior in NR Cooling Hole

Reflooding begins when the lower plenum of the reactor vessel is completely filled with water. The core and NR which surrounds the circumference of the core (see Figure 3.5-10), begin to reflood with ECC water after the lower plenum is filled. At this stage, the temperature of the NR is lower than the core temperature and is higher than the reflood water temperature. Figure 3.5-11 shows the flow regimes and heat transfer modes anticipated in the NR region.

In the upper region of this column, liquid droplets and liquid lumps are generated, as shown in Figure 3.5-11. Heat transfer modes under these flow regimes are classified as follows.

Consequently, the NR wall is cooled down by steam, liquid droplets, the water column and other mechanisms generated under the water level. It is a characteristic of the thermal hydraulics at the reflooding stage of the NR that the mechanisms of heat transfer and flow regimes like these rise to the upper region of the NR as the reflooding event progresses.

3.5.3.2 Applicability of WCOBRA/TRAC

3.5.3.3 Flow Regime in WCOBRA/TRAC

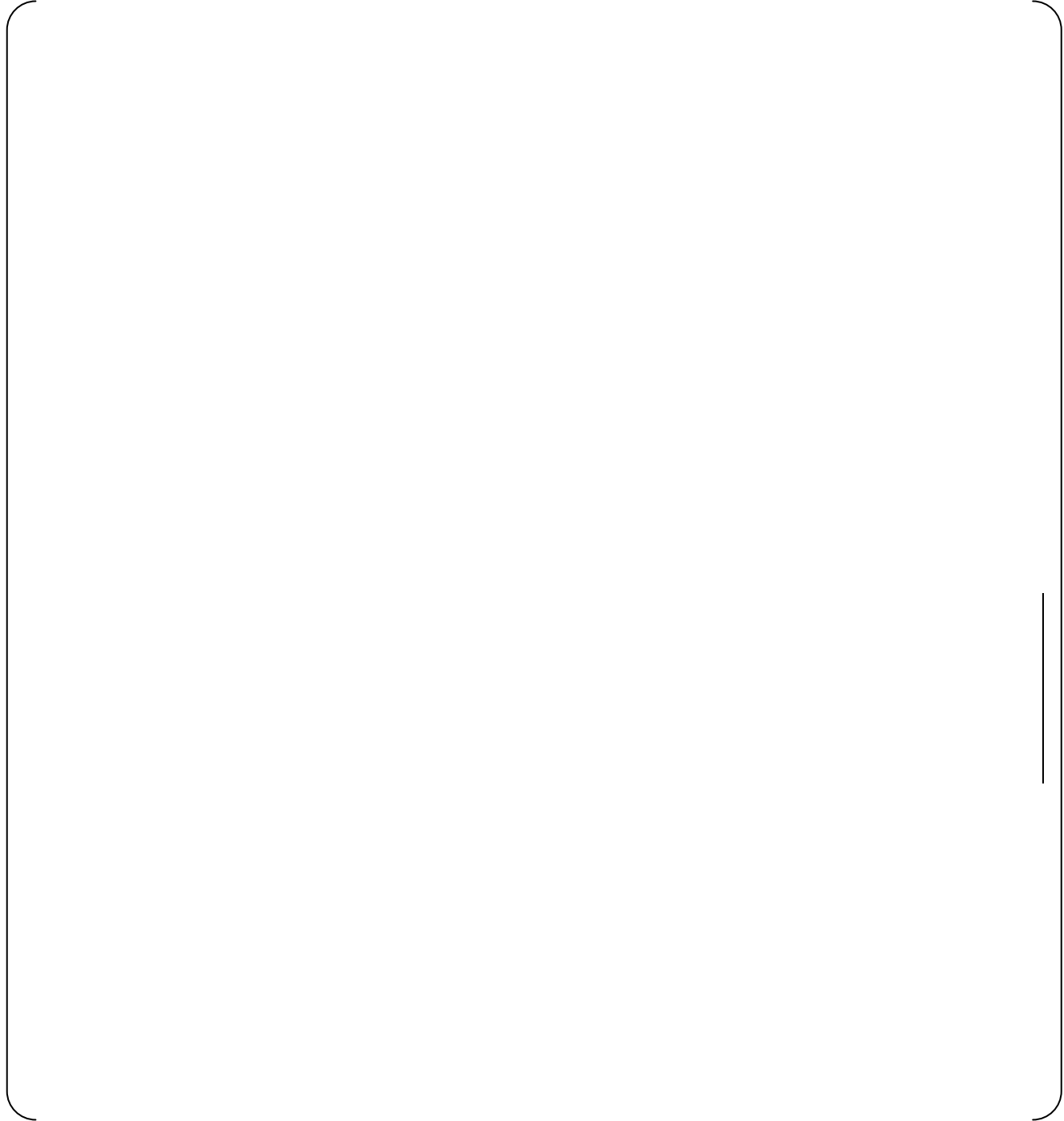

Table 3.5-9 Phenomena/Model in WCOBRA/TRAC for NR

A large, empty rectangular frame with rounded corners, intended for the content of Table 3.5-9. The frame is currently blank.

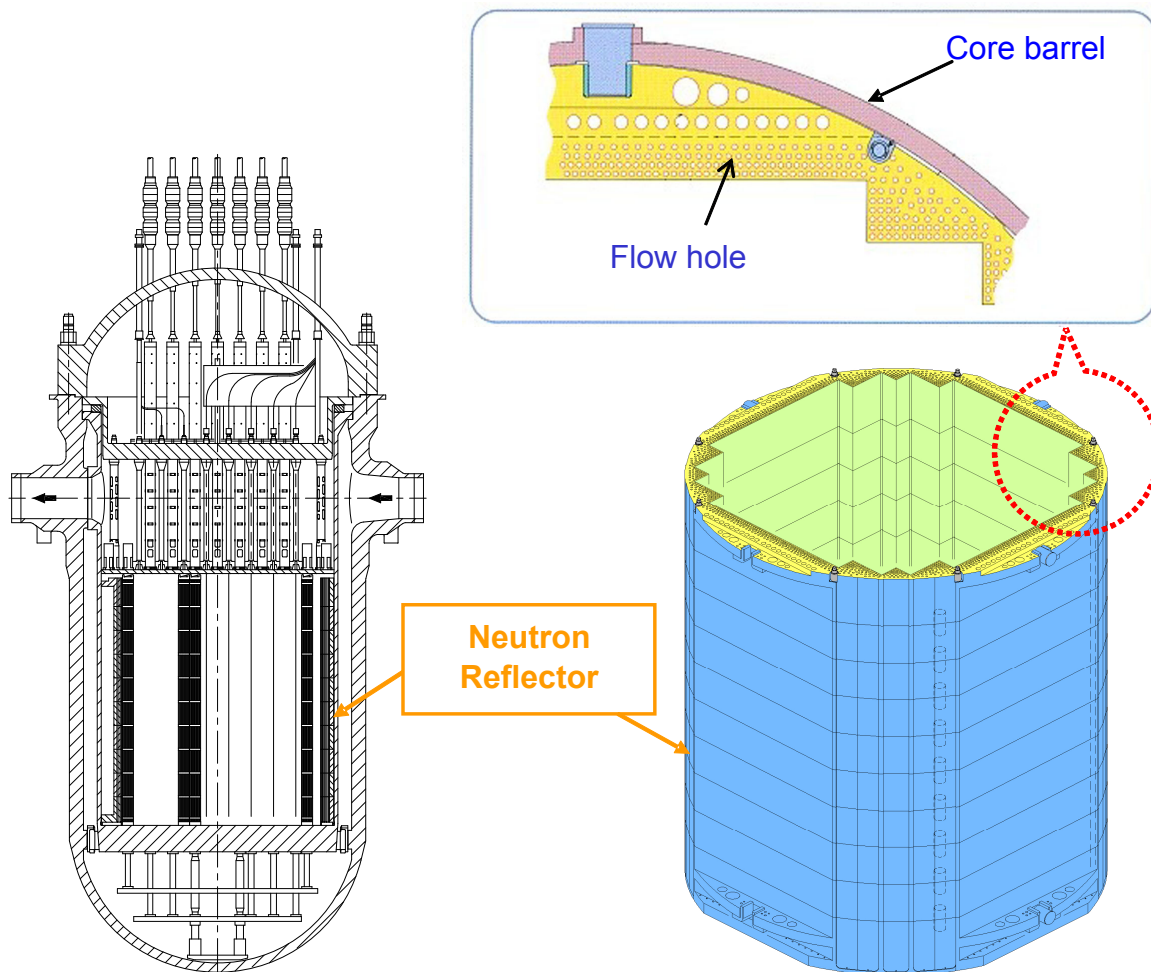

Figure 3.5-10 Neutron Reflector Configuration of US-APWR



Figure 3.5-11 Flow Regimes and Heat Transfer Modes at Cooling Holes in Neutron Reflector during Reflooding Period



Figure 3.5-12 Normal Wall Flow Regimes

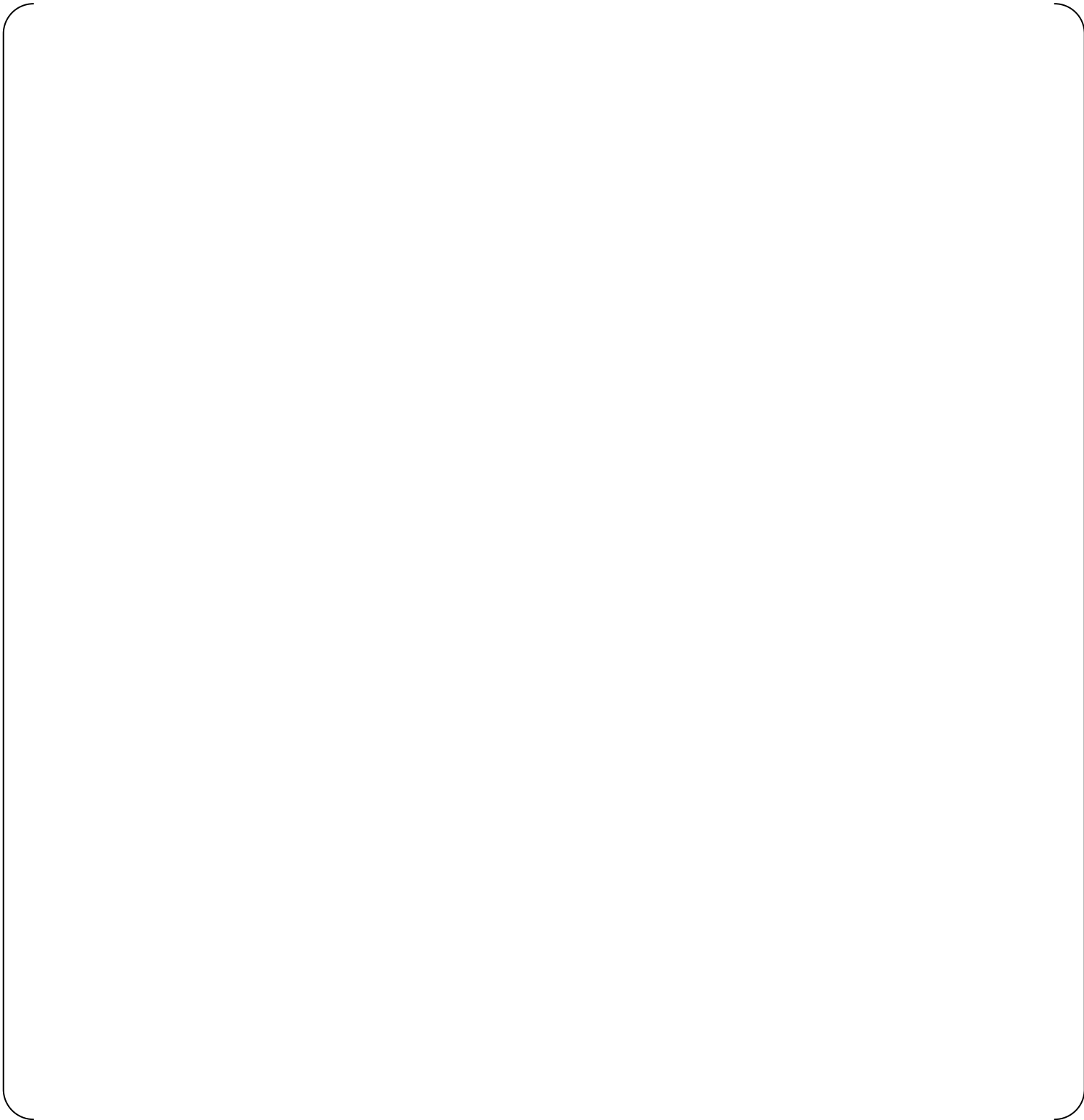

Figure 3.5-13 Hot Wall Flow Regimes

3.6 Sample Plant Analysis

3.6.1 Nodalization of Plant Analysis

Nodalization for the US-APWR is established based on the same scheme used for the Westinghouse conventional 3- and 4-loop PWRs, as discussed in the WCOBRA/TRAC Code Qualification Document (Ref.6).

3.6.1.1 Vessel Model

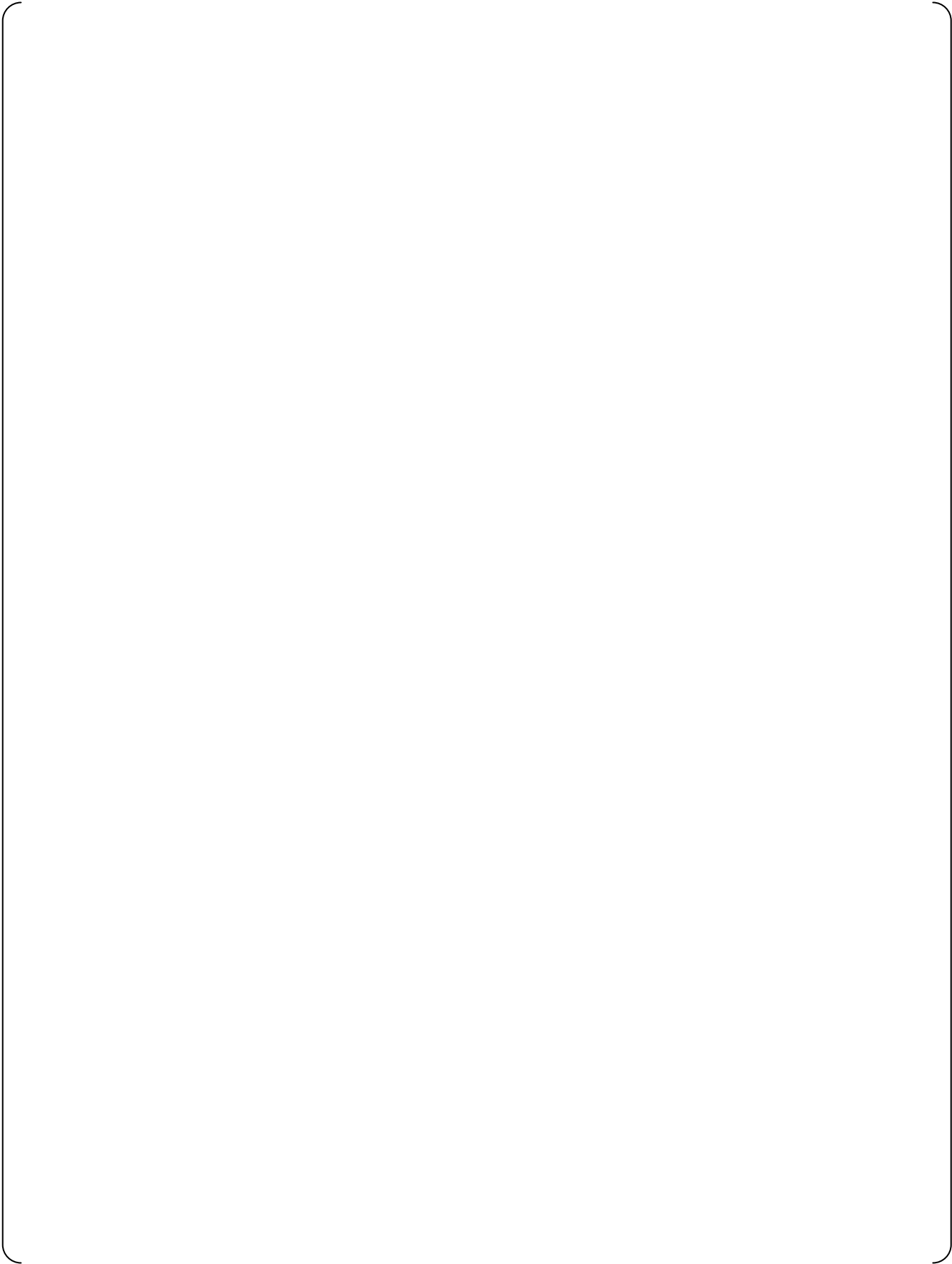

3.6.1.2 Core Model

3.6.1.3 Loop Model

3.6.2 Calculation Process

3.6.2.1 Steady-State Calculation

The PWR LOCA calculation by WCOBRA/TRAC(M1.0) is initialized from a state in which the flow, the temperature, the power, and the pressure can be roughly considered to be stationary. WCOBRA/TRAC(M1.0) steady-state calculations are performed before the transient calculations to ensure that the desired steady-state PWR conditions are achieved.

Steady-state acceptance criteria are based on design information. [

]

3.6.2.2 Transient Calculation

The transient calculation is performed continuously if the obtained steady-state calculation results satisfy the acceptance criteria.

For the transient calculation, a postulated double-ended guillotine break or a split break are assumed to occur in one of the cold legs. The broken cold leg 1-D component arrangements are the same as shown in section 11-2 of Ref.5.

[

GOTHIC code (Ref.13,14,15) is used for containment backpressure analysis.

] The

3.6.3 Models for Sample Plant Analysis

3.6.3.1 NR Hot Wall Model

3.6.3.2 Homologous Pump Curves for the US-APWR RCP

The RCP of the US-APWR is just a larger version of the 93A RCP used for the conventional Westinghouse design PWR. The US-APWR RCP is a centrifugal type RCP and the same type as 93A RCP.

The WCOBRA/TRAC code has a pump model that is designed to model any centrifugal pump and which can include two-phase effects (Ref.6).

The pump model in the WCOBRA/TRAC code is an empirical model based on single- and two-phase flow data from scaled pumps (Ref.6).

The pump head and torque during two-phase flow are assumed to vary as a function of void fraction from the single-phase value to a “fully degraded” or minimum value that occurs at intermediate void fractions (Ref.6).

For the pump head:

$$H = H_1 + M(\alpha) \cdot (H_2 - H_1) \quad (3.6.3-1)$$

where:

- H = Pump head
- H_1 = Single-phase pump head
- H_2 = Fully degraded pump head
- $M(\alpha)$ = Two-phase head multiplier

For the pump torque:

$$T = T_1 + N(\alpha) \cdot (T_2 - T_1) \quad (3.6.3-2)$$

where:

- T = Pump torque
- T_1 = Single-phase pump torque
- T_2 = Fully degraded pump torque
- $N(\alpha)$ = Two-phase torque multiplier

Two-phase performance (fully degraded homologous curves and the two-phase multiplier) of the 93A RCP model was established by using 1/3-scale model air/water test data of a 93A pump carried out at Purdue University (Ref.16).

Generally, the specific speed is a function of the similarity between pumps. The specific

speed, N_s , is defined by;

$$N_s = \frac{\omega_R \sqrt{Q_R}}{(H_R)^{3/4}} \quad (3.6.3-3)$$

where:

- ω_R = Rated pump speed (rpm)
- Q_R = Rated volumetric flow rate (gpm)
- H_R = Rated head (ft)

Table 3.6-3 shows pump rated characteristics of a 1/3-scale model of the 93A RCP model (Ref.6), the full scale 93A RCP model (Ref.17) and the US-APWR RCP model.

As shown in Table 3.6-4, the specific speed of the US-APWR RCP model is very similar to those of the 1/3-scale model of the 93A model and the 93A model. Therefore, two-phase performance [] of the US-APWR RCP can be obtained by using data from 1/3 scale model of the 93A air/water test (Ref.16).

[

] The results are shown in Figure 3.6-9 and Figure 3.6-10.

The fully degraded homologous curves of the US-APWR RCP model are similar to those of the 93A model (Ref.6).

As shown in Figure 3.6-11 and Figure 3.6-12, [

] Therefore, []

Ultimately, [

]

The effect of scaling is minimized in the US-APWR RCP model by using data from the Westinghouse 1/3 scale model, which is very similar in specific speed to the US-APWR RCP. Therefore, []

3.6.3.3 Containment Pressure Calculation Model

The GOTHIC code is used for minimum containment pressure analysis. Containment pressure by GOTHIC is used as the boundary conditions of the break in WCOBRA/TRAC(M1.0). Minimum containment pressure analysis is performed according to SRP6.2.1.5 (Ref.18) requirements.

3.6.4 Analysis Conditions

Major LOCA parameters for WCOBRA/TRAC are divided into the following three categories as in Ref.5.

Plant Physical Description
Plant Initial Operating Conditions
Accident Boundary Conditions

The US-APWR sample plant analysis conditions and the assumptions in major LOCA parameters for WCOBRA/TRAC(M1.0) are listed in Table 3.6-5.

3.6.5 Analysis Results

The transient is initiated from the end of the steady-state run with the break model inserted in the broken loop. The sequence of events for the transient shown in Table 3.6-6 represents the forced events (e.g., trips, etc) and those observed in the calculation (e.g., end of blowdown, etc).

3.6.5.1 Blowdown Phase

During the first few seconds of the transient, the flow is split, DNB occurs and the cladding temperature rises promptly as the core power is reduced. Figure 3.6-14 shows the peak cladding temperature of the hot rod.

Figure 3.6-15 shows hot channel core flow rate. In the early blowdown phase, the core flow direction is upward and core heat transfer takes place as a two-phase mixture that is pushed into the core. The end of this phase occurs when the lower plenum mass is depleted, flow in the loops becomes two-phase, and the pump head is degraded.

Figure 3.6-16 shows core pressure. The RCS depressurization has progressed, and the break flow begins to dominate and pulls flow downward away from the core. As the system pressure continues to decrease, the break flow and the core flow are reduced consequentially.

3.6.5.2 Refilling Phase

In this phase, core heat-up continues when the lower plenum is filled with advanced accumulator injection water. Figure 3.6-17 shows the lower plenum collapsed liquid level. When the advanced accumulator injection water fills the lower plenum and begins to enter the core, the refill phase ends.

3.6.5.3 Reflooding Phase

In the sample analysis, the reflooding phase starts about 36 seconds from the beginning of the break. In this phase, coolant enters the core from the bottom and entrainment begins. As a result, core heat transfer increases. Figure 3.6-19 shows accumulator flow rate. The flow rate of the advanced accumulators switches from high flow to low flow at about 56 seconds, and after about 2 seconds, the reflooding PCT is reached. After reaching the PCT, core reflooding progresses and cladding temperature decreases. The reactor core is quenched in about 220 seconds, and this phase ends.

3.6.6 Sample Plant Analysis Summary

The phenomena observed in the sample analyses of the US-APWR are very similar to those occurring in a Westinghouse 4-loop PWR. WCOBRA/TRAC(M1.0) with the minor modifications for the improved features of the US-APWR can adequately model the US-APWR LBLOCA performance.

Table 3.6-1 Channel Descriptions for US-APWR Vessel Model (1/3)



Table 3.6-1 Channel Descriptions for US-APWR Vessel Model (2/3)



Table 3.6-1 Channel Descriptions for US-APWR Vessel Model (3/3)



Table 3.6-2 Gap Connections for US-APWR Vessel Model (1/3)

Table 3.6-2 Gap Connections for US-APWR Vessel Model (2/3)



Table 3.6-2 Gap Connections for US-APWR Vessel Model (3/3)



Table 3.6-3 Comparison of Rated Characteristics of Various Pumps



Table 3.6-4 Comparison of Specific Speed of Various Pumps



Table 3.6-5 Analysis Conditions for US-APWR

Parameter	Values
Plant Physical Description	
a) Dimensions	
b) Flow Resistance	
c) Pressurizer Location	
d) Hot Assembly Location	
e) Hot Assembly Type	
f) SG Plugging Level	
Plant Initial Operating Conditions (Reactor Power)	
a) Core Power	
b) Peak Relative Linear Heat Rate	
c) Hot Rod Relative Average Power	
d) Hot Assembly Rel. Average Heat Rate	
e) Hot Assembly Rel. Peak Linear Heat Rate	
f) Axial Power Distribution	
g) Low-power Region Rel. Power	
Plant Initial Operating Conditions (Fluid Conditions)	
a) Tavg	
b) Pressurizer Pressure	
c) Loop Flow	
d) Upper Head Temperature	
e) Pressurizer Level	
f) Accumulator Temperature	
g) Accumulator Pressure	
h) Accumulator Water Volume except dead water volume	
i) Accumulator Line Flow Resistance	
j) Accumulator Boron Concentration	
Accident Boundary Conditions	
a) Break Location	
b) Break Type	
c) Break Size	
d) Offsite Power	
e) Safety Injection Flow	
f) Safety Injection Temperature	
g) Safety Injection Delay	
h) Containment Pressure	
i) Single Failure	
j) Control Rod Drop Time	

Table 3.6-6 Sequence of Events for US-APWR Sample Transient Analysis

Time	Event after DECLG Break
0 sec	DECLG break occurs
6 sec	SI signal issued
- 10 sec	Upwards Flow Phase
11 sec	Blowdown PCT 1563 °F (851°C) at about 10.8 ft (no ECC contribution)
13 sec	Accumulator injection started
36 sec	Refill ended
56 sec	Accumulator injection switched from high flow to low flow
58 sec	Reflooding PCT 1669 °F (909°C) at 10.3 ft
124 sec	SI injection started
- 220 sec	Core quenched



Figure 3.6-1 US-APWR Vessel Profile

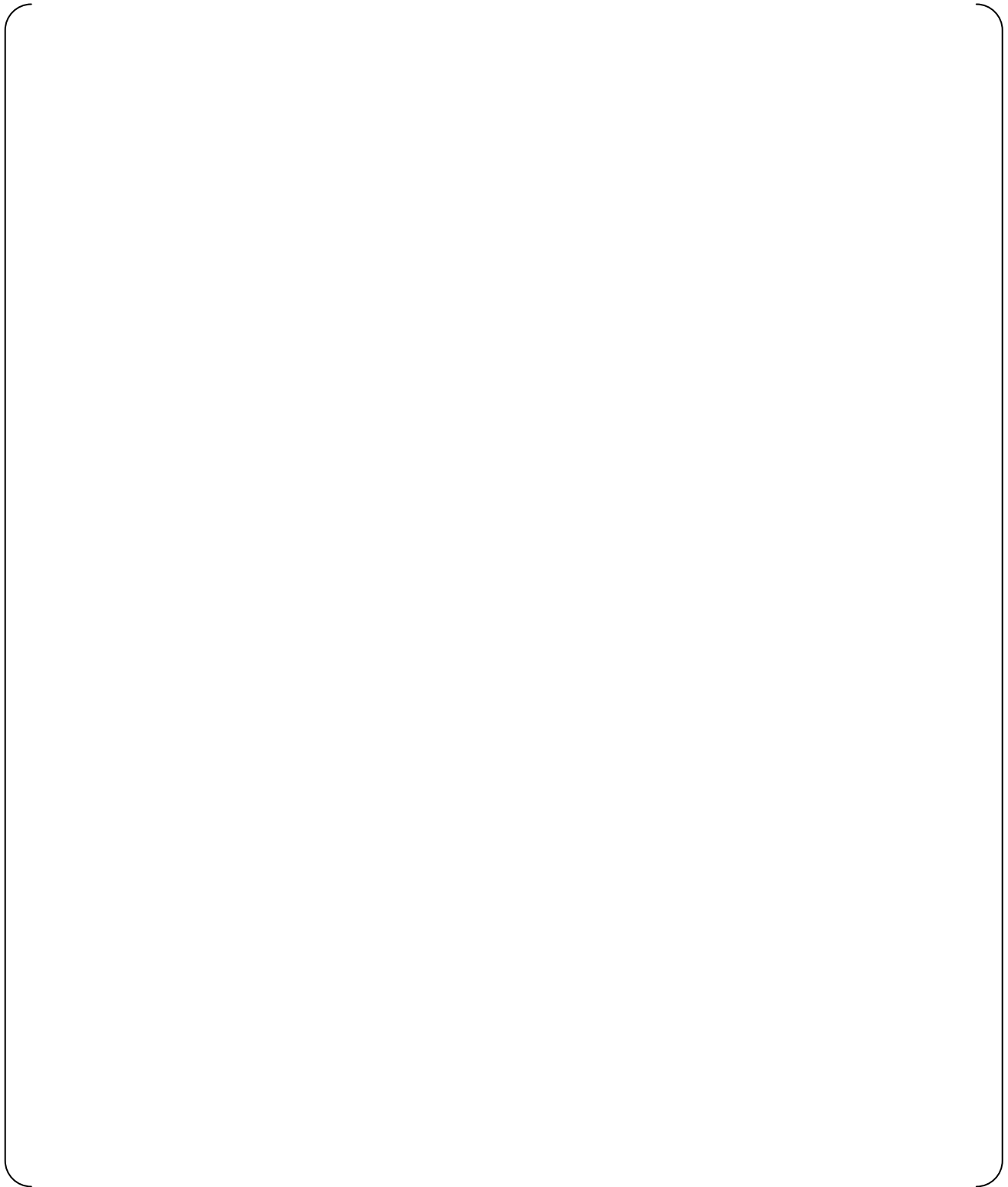

Figure 3.6-2 US-APWR Vessel Noding for Hot Assembly Under either Support Column or Open Hole (Vertical View)

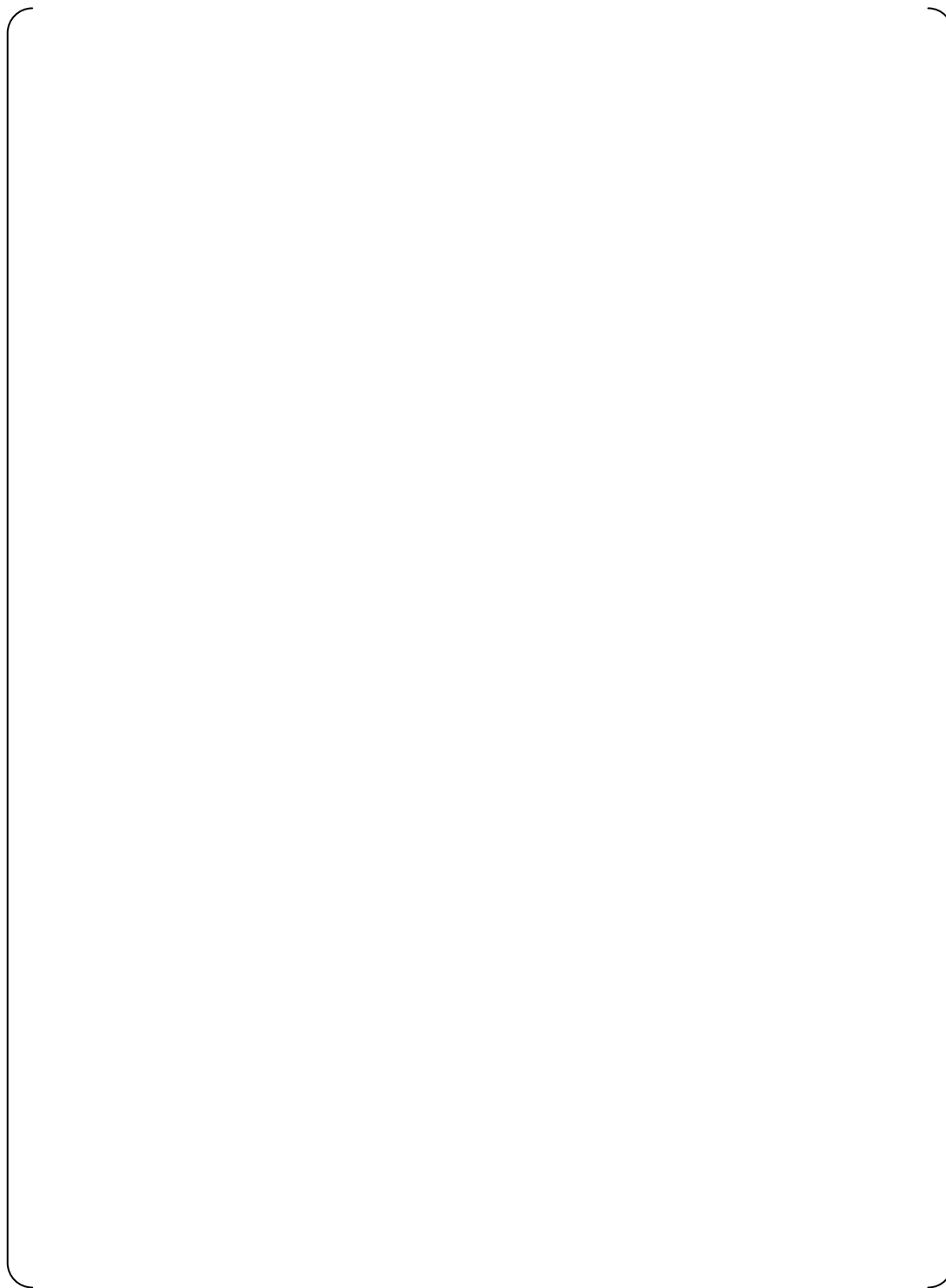

Figure 3.6-3 US-APWR Vessel Sections 1 to 2 (Horizontal View)

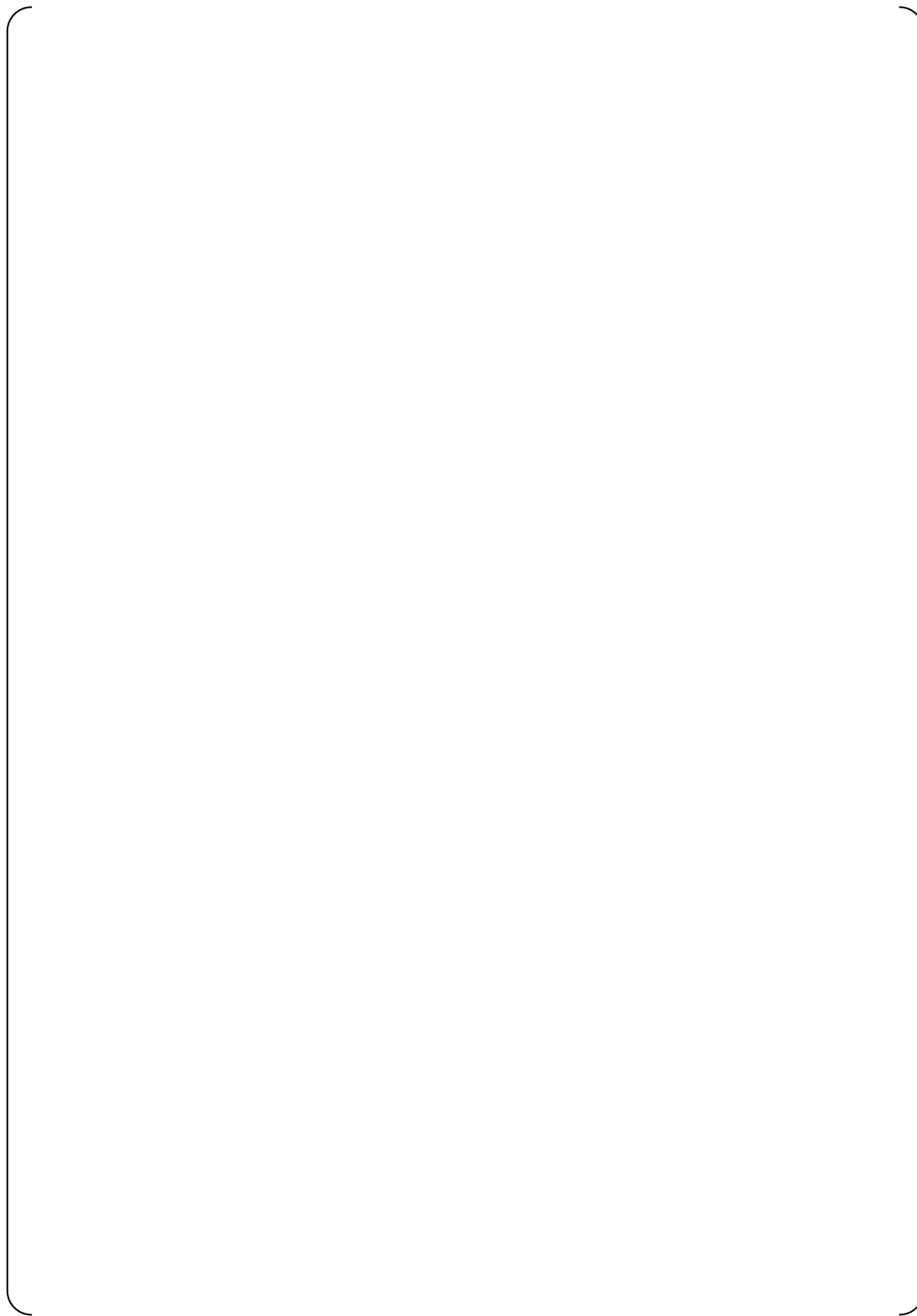

Figure 3.6-4 US-APWR Vessel Sections 3 to 4 (Horizontal View)

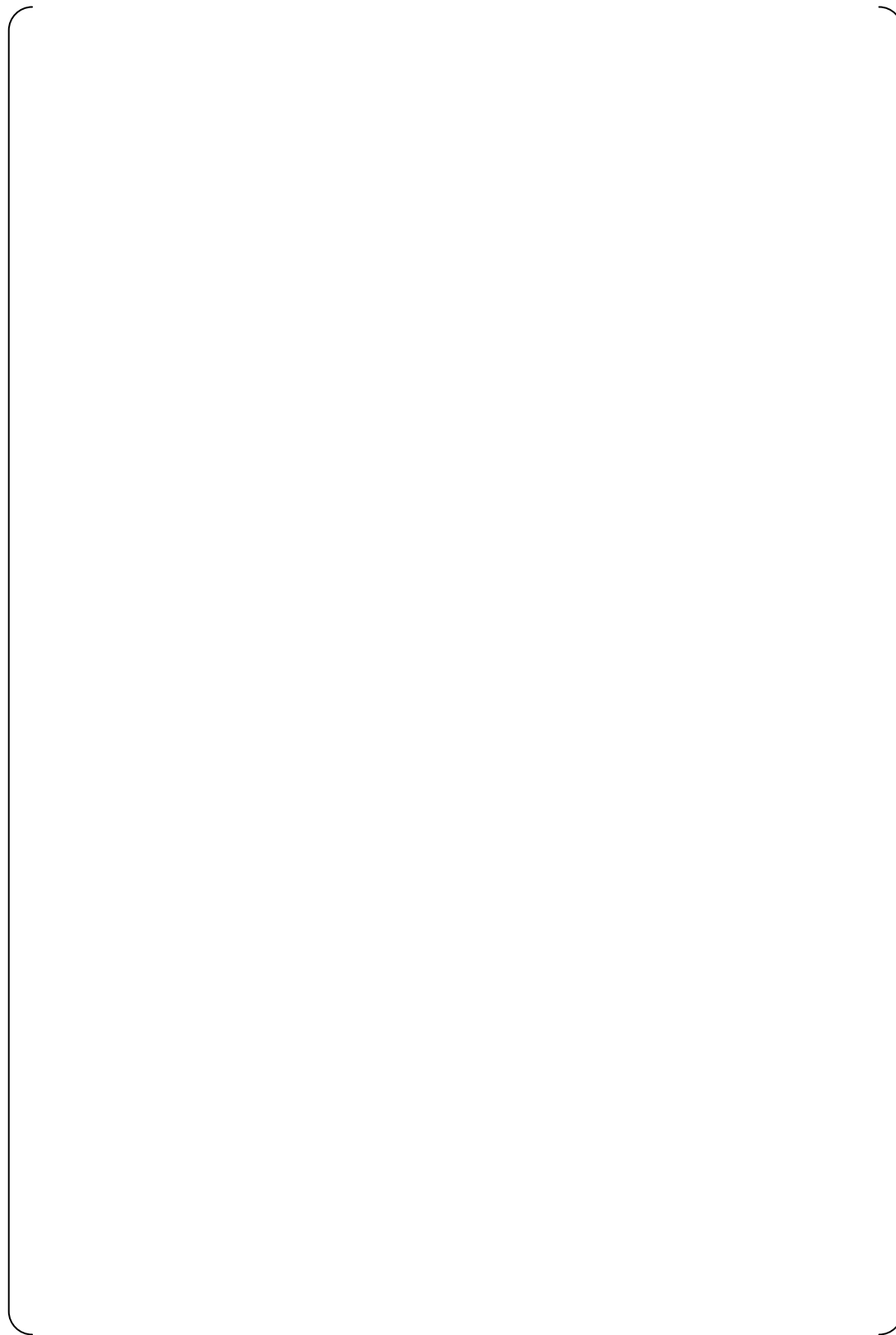

Figure 3.6-5 US-APWR Vessel Sections 5 to 6 (Horizontal View)

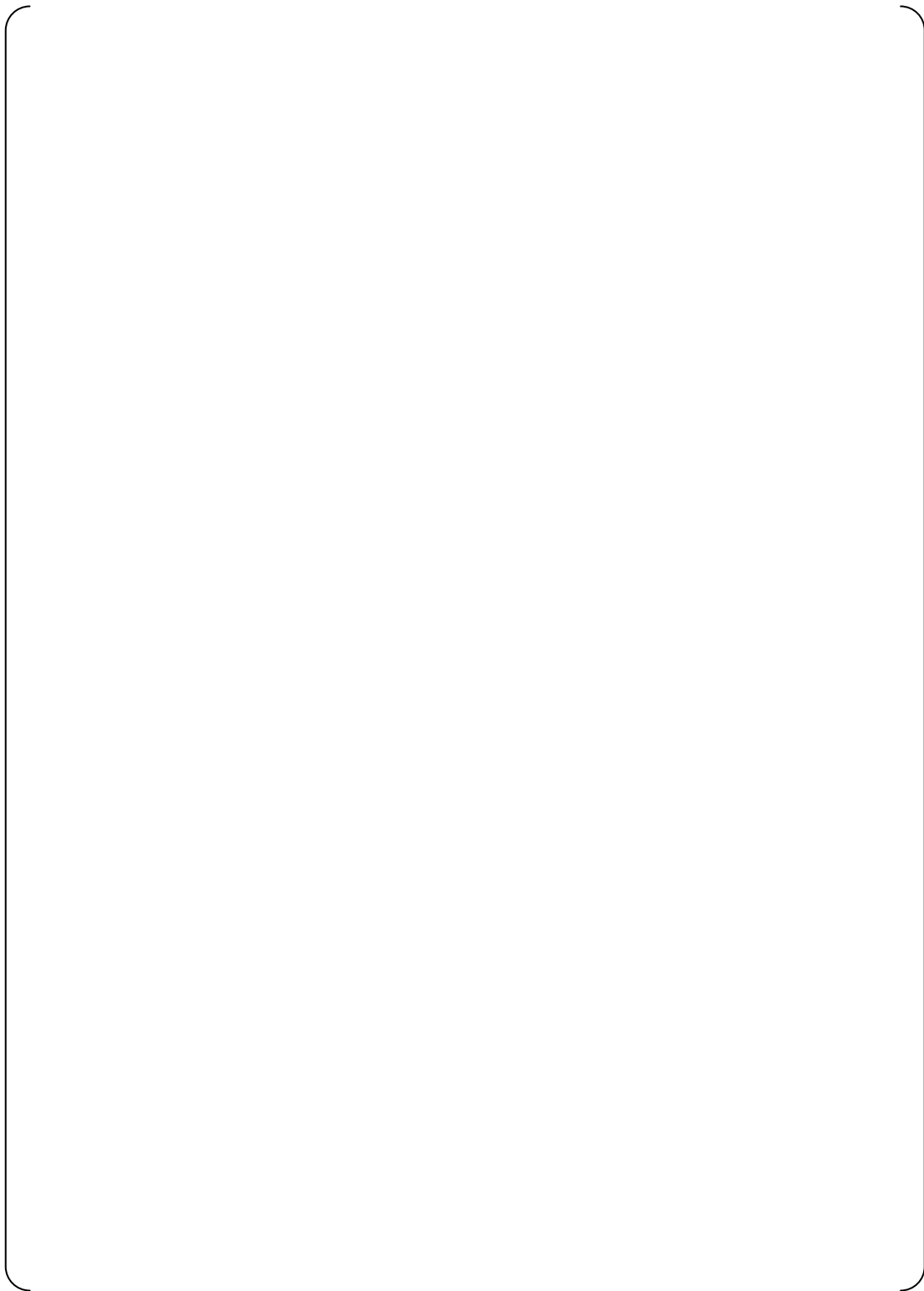

Figure 3.6-6 US-APWR Vessel Sections 7 to 8 (Horizontal View)

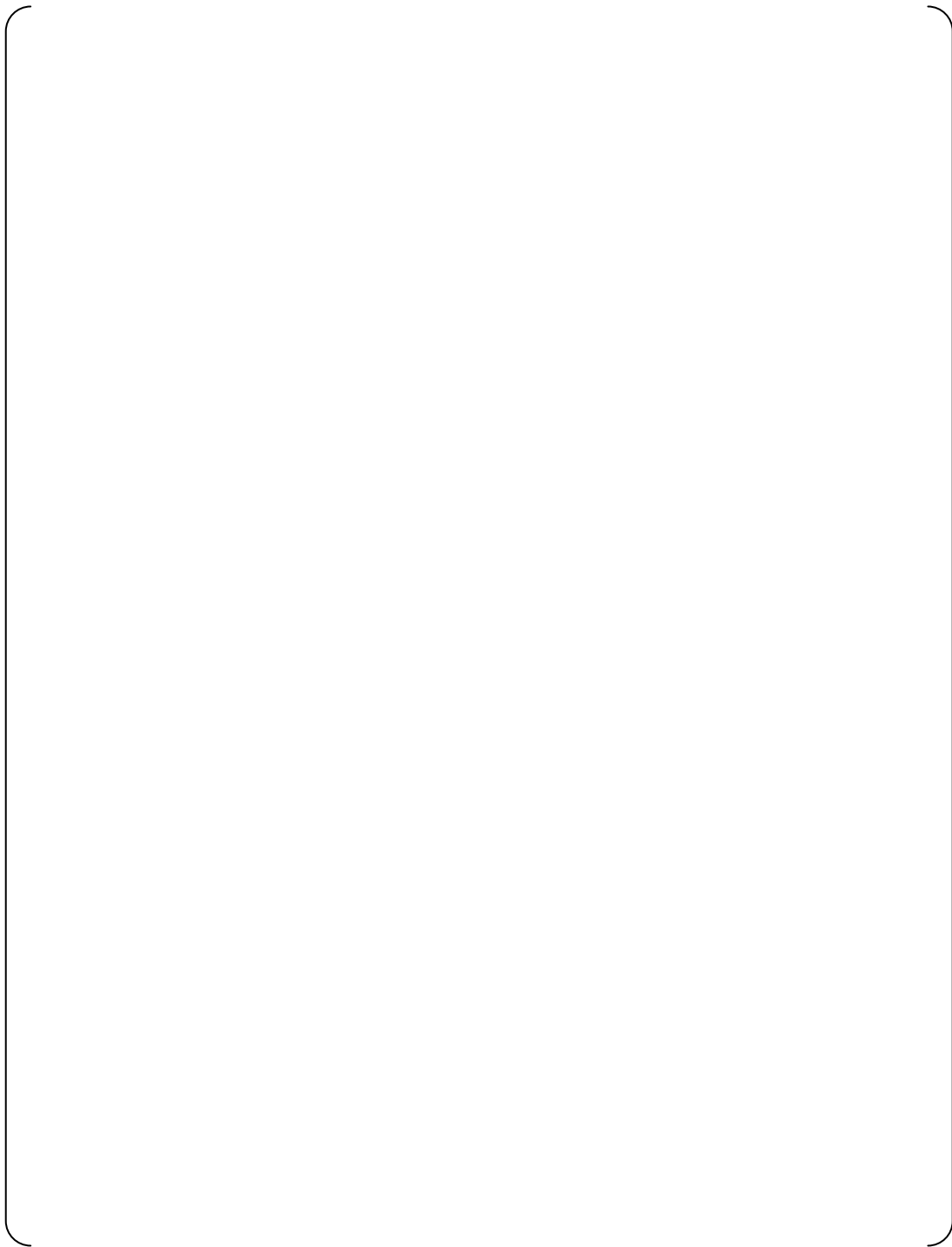

Figure 3.6-7 US-APWR Vessel Sections 9 to 10 (Horizontal View)

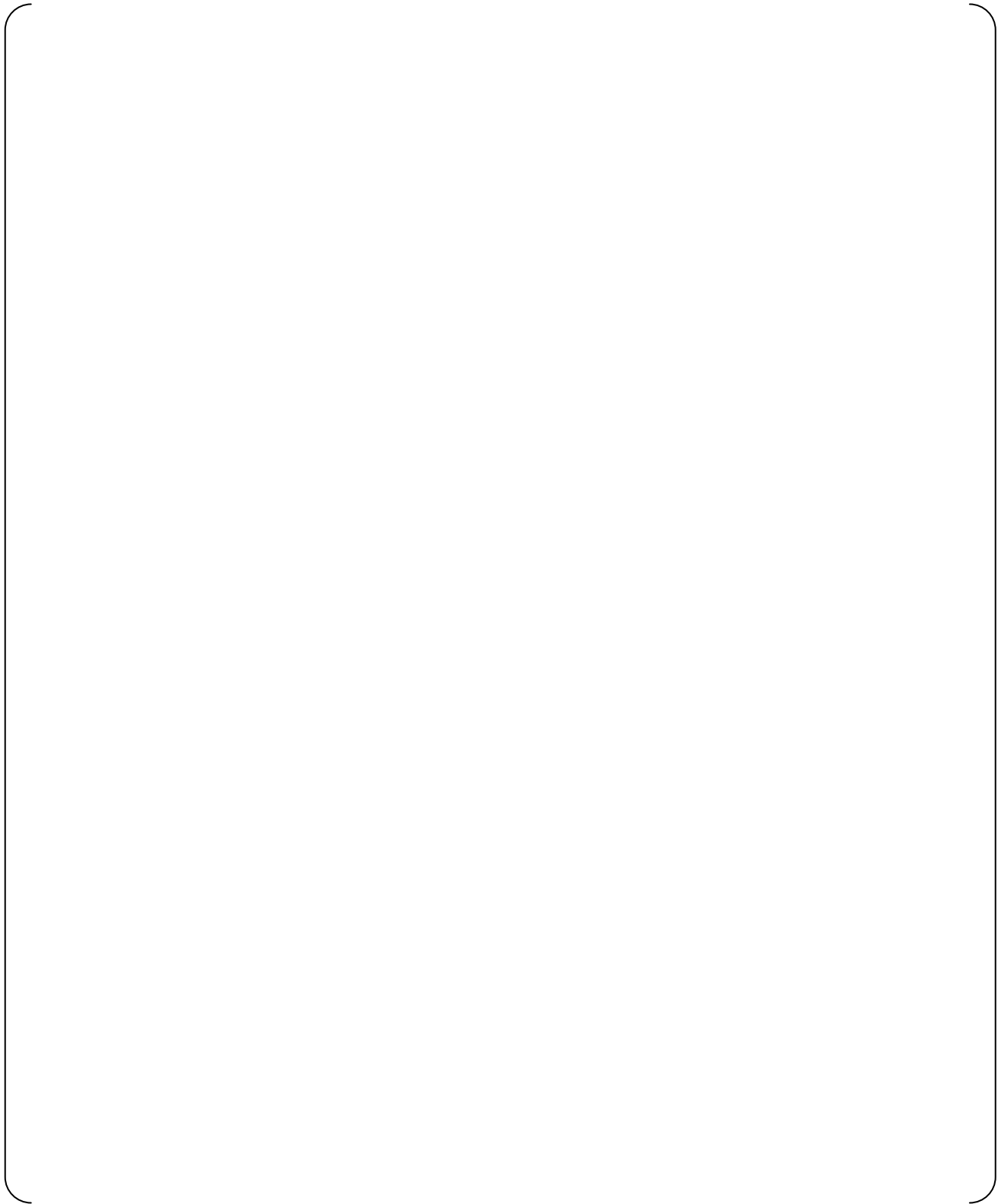

Figure 3.6-8 US-APWR WCOBRA/TRAC(M1.0) Model Vessel/Loop Layout



Figure 3.6-9 US-APWR RCP Homologous Single-phase and Two-phase Pump Head Curve



Figure 3.6-10 US-APWR RCP Homologous Single-phase and Two-phase Pump Torque Curve



Figure 3.6-11 US-APWR RCP Two- Phase Head Multiplier



Figure 3.6-12 US-APWR RCP Two- Phase Torque Multiplier



Figure 3.6-13 Sample Power Shape for US-APWR Analysis

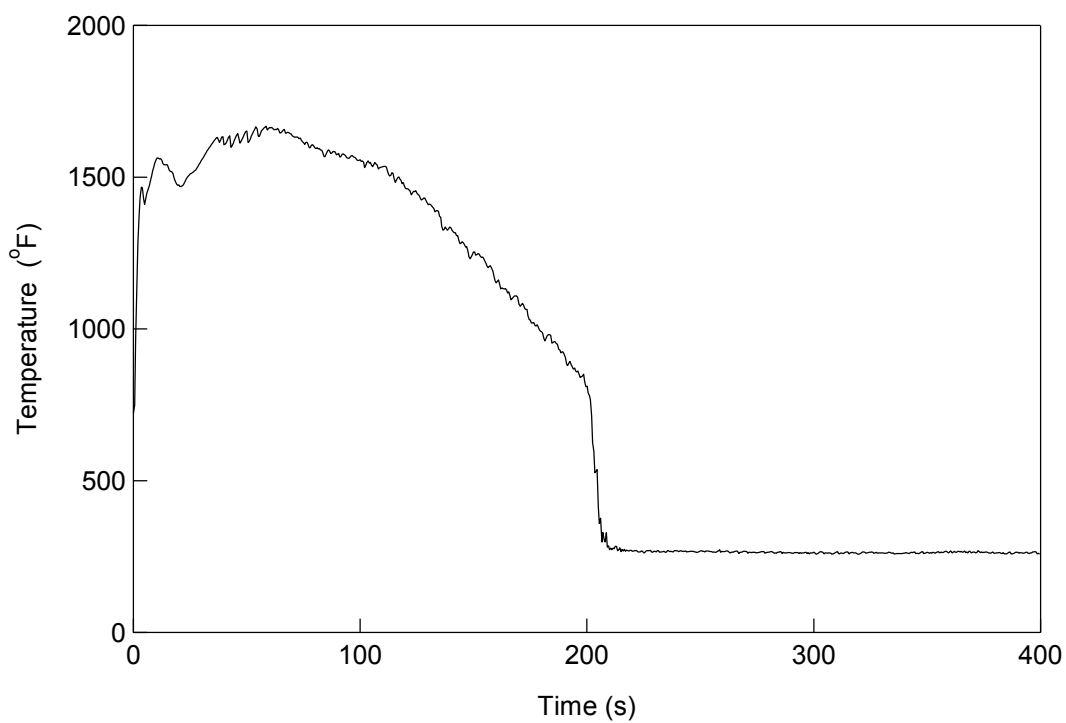

Figure 3.6-14 Peak Cladding Temperature of Hot Rod

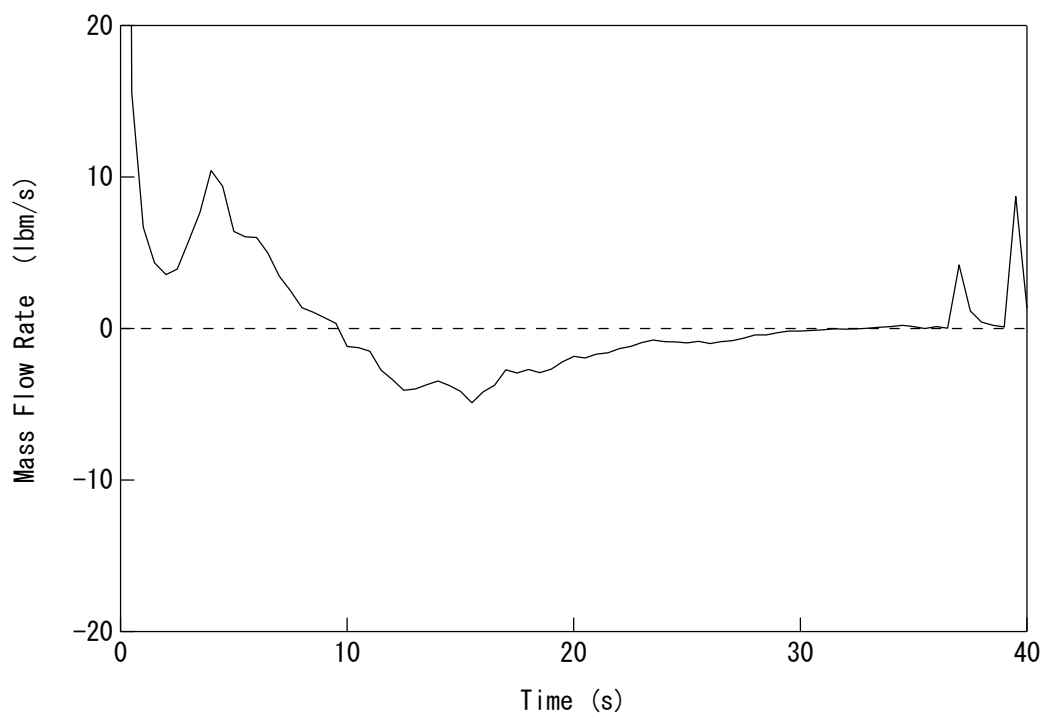

Figure 3.6-15 Hot Assembly Channel Total Flow Rate

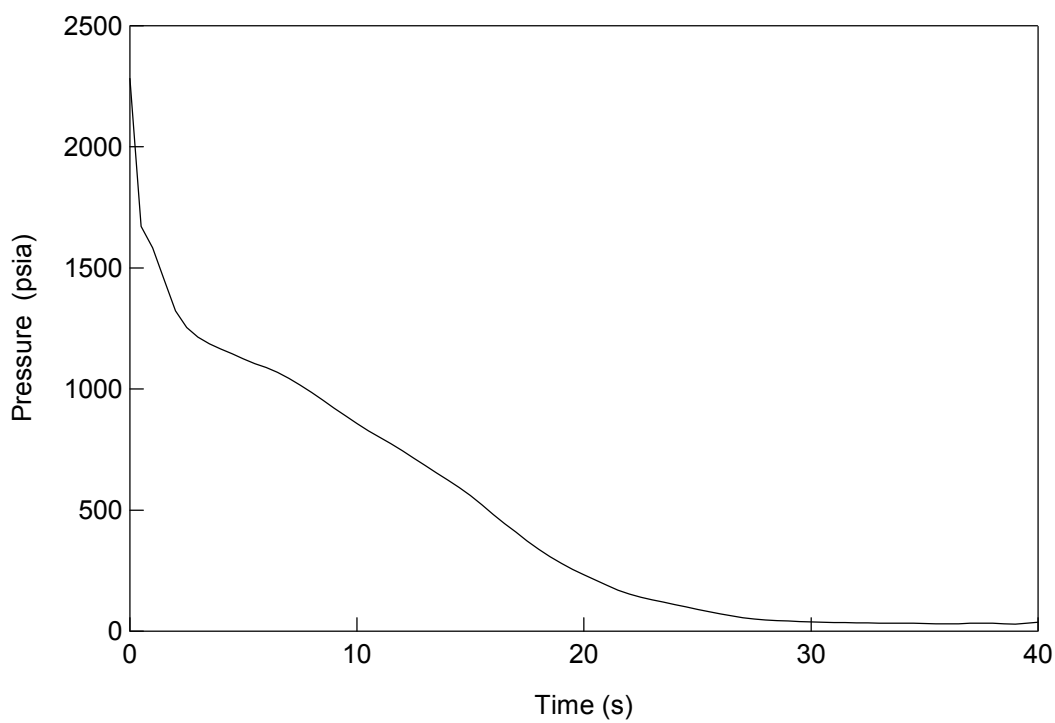
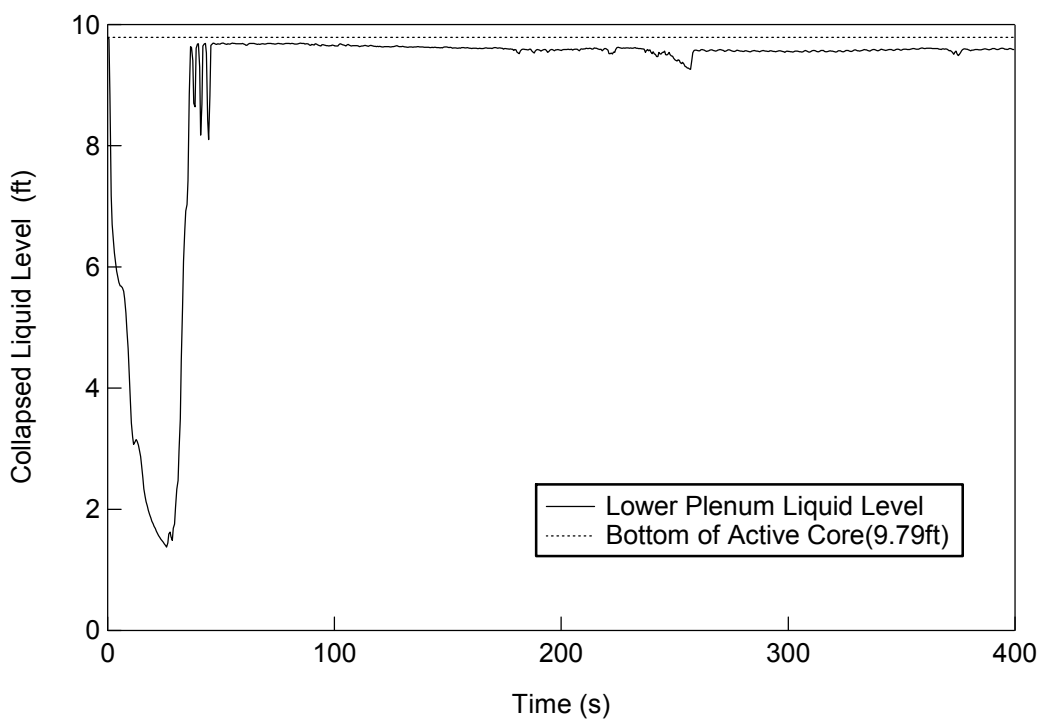

Figure 3.6-16 Core Pressure



Collapsed Liquid Level: Section 1 and 2

Figure 3.6-17 Lower Plenum Liquid Level

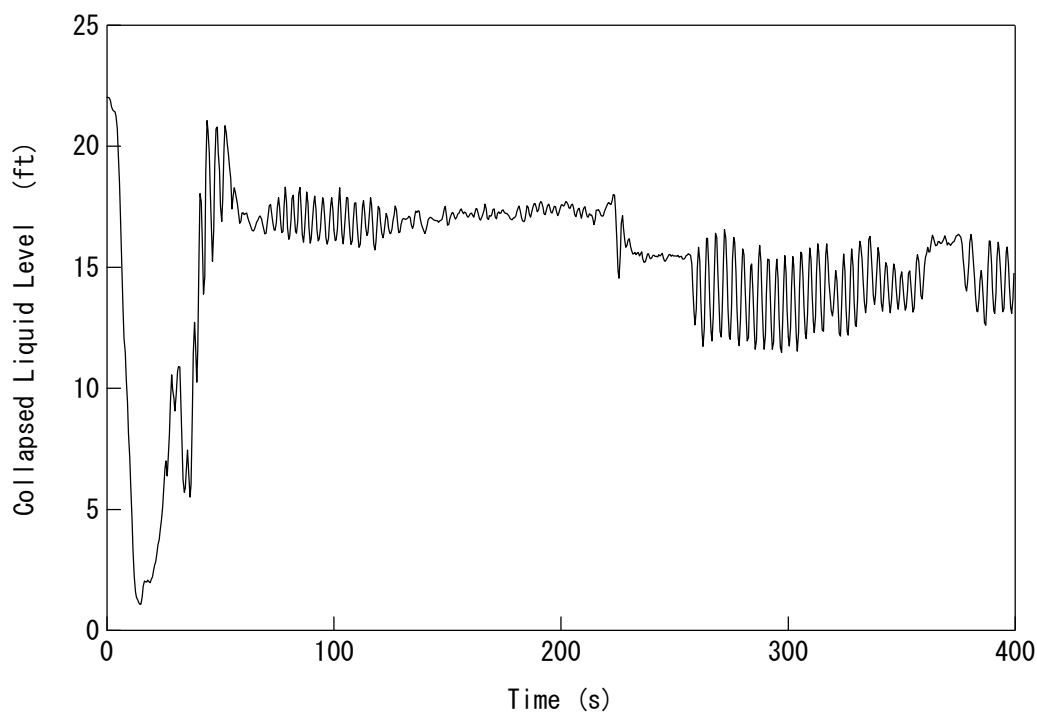

Figure 3.6-18 Downcomer Liquid Level

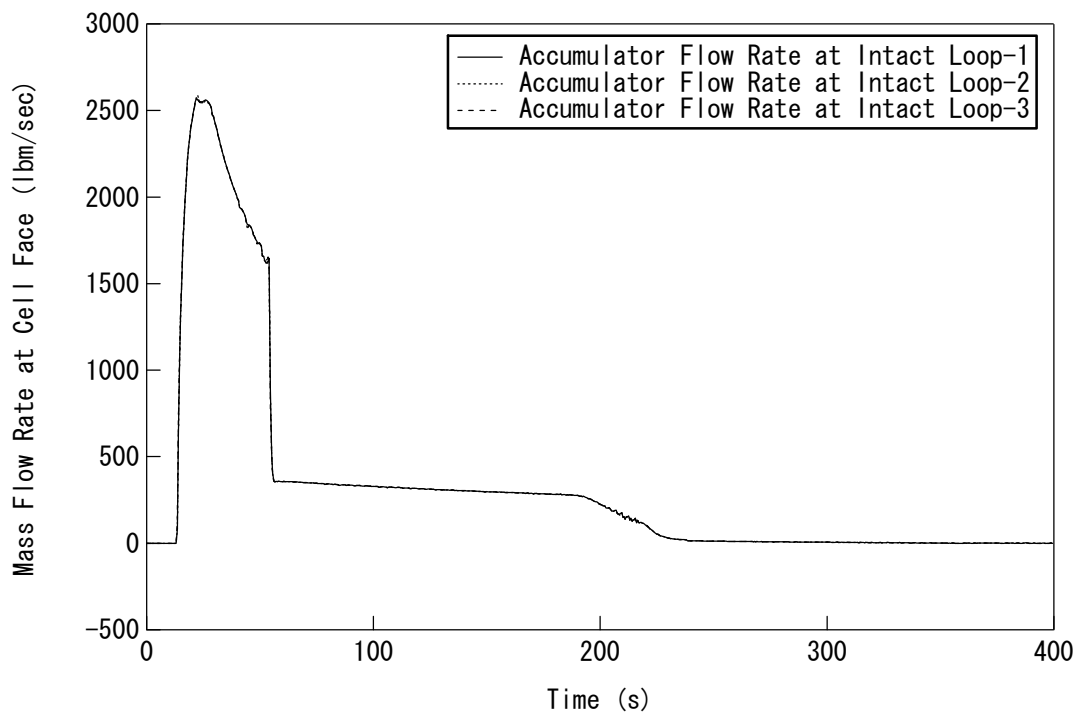

Figure 3.6-19 Accumulator Flow Rate

3.7 ASTRUM Methodology Applied to US-APWR

3.7.1 Statistical Methodology of ASTRUM

The ASTRUM methodology was approved by the NRC for the Westinghouse 2-,3- and 4-loop PWRs and the CE design PWR as WCAP-16009-P-A Rev.0 (Ref.5).

The ASTRUM methodology of using Monte Carlo sampling of the inputs for 124 runs of WCOBRA/TRAC demonstrates the conformance of the computed numerical values of peak cladding temperature, maximum local oxidation and core-wide oxidation to the acceptance criteria of 10 CFR 50.46 at the 95/95 tolerance level and, therefore, is acceptable.

The methodology for the consideration of non-parametric tolerance limits was presented by Wilks (Ref.19). The sampling is achieved by executing several calculations in which all uncertainty parameters are simultaneously ranged within their distributions. The results of the calculations are ranked based on the value assumed by the parameters in question (e.g., PCT, etc.) for each of the calculations. The maximum value is expected to bound a certain fraction of the population of the parameter with a given confidence level.

The sample size determines the cumulative probability and the confidence level. There is one parameter that should be evaluated: the sample size, N=59, is derived from the following Wilks' formula in order to obtain a 95/95 value.

$$1 - \alpha^N > \beta \quad (3.7-1)$$

α : Probability = 0.95
 β : Confidence level = 0.95
N : Sample size

The 10 CFR 50.46 rule requires that the following acceptance criteria be met in order to confirm adequate ECCS performance under LOCA transient.

- The calculated maximum fuel element cladding temperature shall not exceed 2200°F.
- The calculated total oxidation of the cladding shall nowhere exceed 0.17 times the total cladding thickness before oxidation.
- The calculated total amount of hydrogen generated from the chemical reaction of the cladding with water or steam shall not exceed 0.01 times the hypothetical amount that would be generated if all of the metal in the cladding cylinders surrounding the fuel, excluding the cladding surrounding the plenum volume, were to react.

It is therefore necessary to evaluate these three parameters. The enhancement of the order statistics was provided by Guba, et al. (Ref.20). In Guba, the sample size N required to bound a fraction b of the population for a number of outcomes, with a probability α is determined by the following formula.

$$\beta = \sum_{k=0}^{N-p} \frac{N!}{(N-k)!k!} \alpha^k (1-\alpha)^{N-k} \quad (3.7-2)$$

α : Probability
 β : Confidence level
 N : Sample size

If the evaluation parameters are written as a matrix formula arranged by sampling size N , it becomes a matrix with N rows and 3 columns as below. The rows indicate each evaluation parameter. In the following matrix, the first row, y_1 , means peak cladding temperature (PCT), the second row, y_2 , means local maximum oxidation (LMO) and the third row, y_3 , means core-wide oxidation (CWO). The rows show each sampling case N .

$$\begin{pmatrix} y_{11} & \cdot & \cdot & \cdot & y_{1N} \\ y_{21} & \cdot & \cdot & \cdot & y_{2N} \\ y_{31} & \cdot & \cdot & \cdot & y_{3N} \end{pmatrix}$$

If y_1 is arranged in ascending order, it becomes as follows. The evaluation value is assumed $y_{1\max} = U_1$. The column U_1 is a result of the case where y_1 is the highest value ($y_{1\max}$) among cases 1 to N . Neither y_2 nor y_3 are listed at these highest values.

$$\begin{pmatrix} y_{11} & \cdot & \cdot & \cdot & y_{1N} & \left| \begin{array}{c} U_1 \\ y_{1\max} \end{array} \right. \\ y_{21} & \cdot & \cdot & \cdot & y_{2N} & \left| \begin{array}{c} \\ y_{2N} \end{array} \right. \\ y_{31} & \cdot & \cdot & \cdot & y_{3N} & \left| \begin{array}{c} \\ y_{3N} \end{array} \right. \end{pmatrix}$$

The matrix is rearranged about y_2 in ascending order excluding the y_2 corresponding to $y_1 = U_1$, and it is assumed that $y_{2\max} = U_2$. There is no correlation between variables. If this procedure can be performed repeatedly, it becomes the following.

$$\begin{pmatrix} y_{11} & \cdot & \cdot & \cdot & \cdot & \left| \begin{array}{c} U_3 \\ \\ \\ \end{array} \right. & \left| \begin{array}{c} U_2 \\ \\ \\ \end{array} \right. & \left| \begin{array}{c} U_1 \\ y_{1\max} \\ \\ \end{array} \right. \\ y_{21} & \cdot & \cdot & \cdot & \cdot & \left| \begin{array}{c} \\ y_{2\max} \\ \\ \end{array} \right. & \left| \begin{array}{c} \\ \\ \\ \end{array} \right. & \left| \begin{array}{c} \\ \\ \\ \end{array} \right. \\ y_{31} & \cdot & \cdot & \cdot & \cdot & \left| \begin{array}{c} \\ \\ y_{3\max} \end{array} \right. & \left| \begin{array}{c} \\ \\ \\ \end{array} \right. & \left| \begin{array}{c} \\ \\ \\ \end{array} \right. \end{pmatrix}$$

In this case, the number of cases in which the screen line is divided is three (U_1 , U_2 and U_3).

$$\beta < 1 - \sum_{k=0}^2 {}_N C_k \alpha^{N-k} (1-\alpha)^k = 1 - \alpha^N - N\alpha^{N-1}(1-\alpha) - \frac{N(N-1)}{2} \alpha^{N-2}(1-\alpha)^2 \quad (3.7-3)$$

From Formula 3.7-3, $N=124$ can be obtained for a probability at $\alpha = 0.95$ and confidence level of $\beta = 0.95$. Therefore, 124 cases are calculated, and each result of three evaluation parameters (PCT, LMO and CWO) of a maximum value will satisfy 95/95. Also, the three evaluation parameters (PCT, LMO and CWO) are independent, therefore PCT, LMO and CWO have been evaluated as conservative estimates.

3.7.2 ASTRUM Methodology Applicability to US-APWR

As discussed in 3.2, the US-APWR and conventional PWRs have very similar designs. And the only minor modifications to the ASTRUM methodology are required to reflect the improved feature of the US-APWR.

Table 3.7-1 through Table 3.7-3 show the uncertainty treatment of ASTRUM methodology for the US-APWR. In the ASTRUM methodology, the treatment of the uncertainty is divided into parameters that affect the thermal hydraulic response of RCS and a local model. The effects of parameters that affect the thermal hydraulic response of RCS are used in the WCOBRA/TRAC (M1.0) code. Local models are used in the HOTSPOT code.

As discussed in 3.6.1, flow resistances of flow damper and accumulator line are treated as uncertainties. For most of parameters, the treatment of uncertainty is the same as for the Westinghouse 3- and 4-loop plants. As a result, the same methodology of uncertainty can be used for the US-APWR.

The best-estimate methodology establishes a sampling of the distribution of PCT that could occur due to changes in plant or model variables. The input values falls under three categories:

- Plant physical description,
- Plant initial operating conditions
- Accident boundary conditions

The uncertainty treatments of local model and global model for the US-APWR are shown in Table 3.7-2 and Table 3.7-3, respectively. The uncertainty treatments of local model and global model are the same as for conventional 4-loop plant (Ref.6).

The following paragraphs describe the assumptions in the key LOCA parameters for US-APWR. The sample case input values as well as the plant operating range. For most of the parameters used in the sample plant analysis, the nominal value was assumed. For others, a bounding or conservative value was assumed.

The uncertainty associated with these parameters is taken into account for the uncertainty analysis.

3.7.2.1 Plant Physical Description



3.7.2.2 Plant Initial Operating Conditions: Reactor Power



3.7.2.3 Plant Initial Operating Conditions: Fluid Conditions

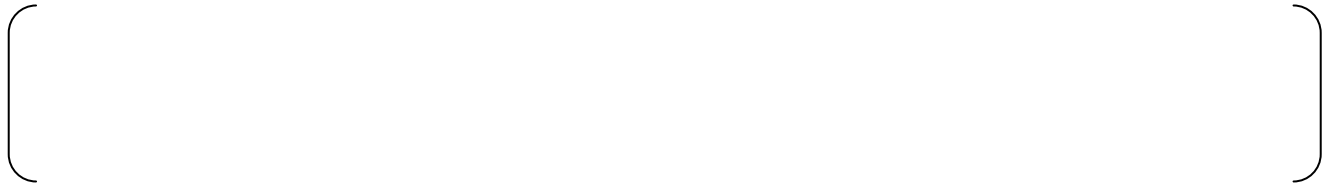

3.7.2.4 Accident Boundary Conditions

Table 3.7-1 Uncertainty Treatment for US-APWR (1/2)

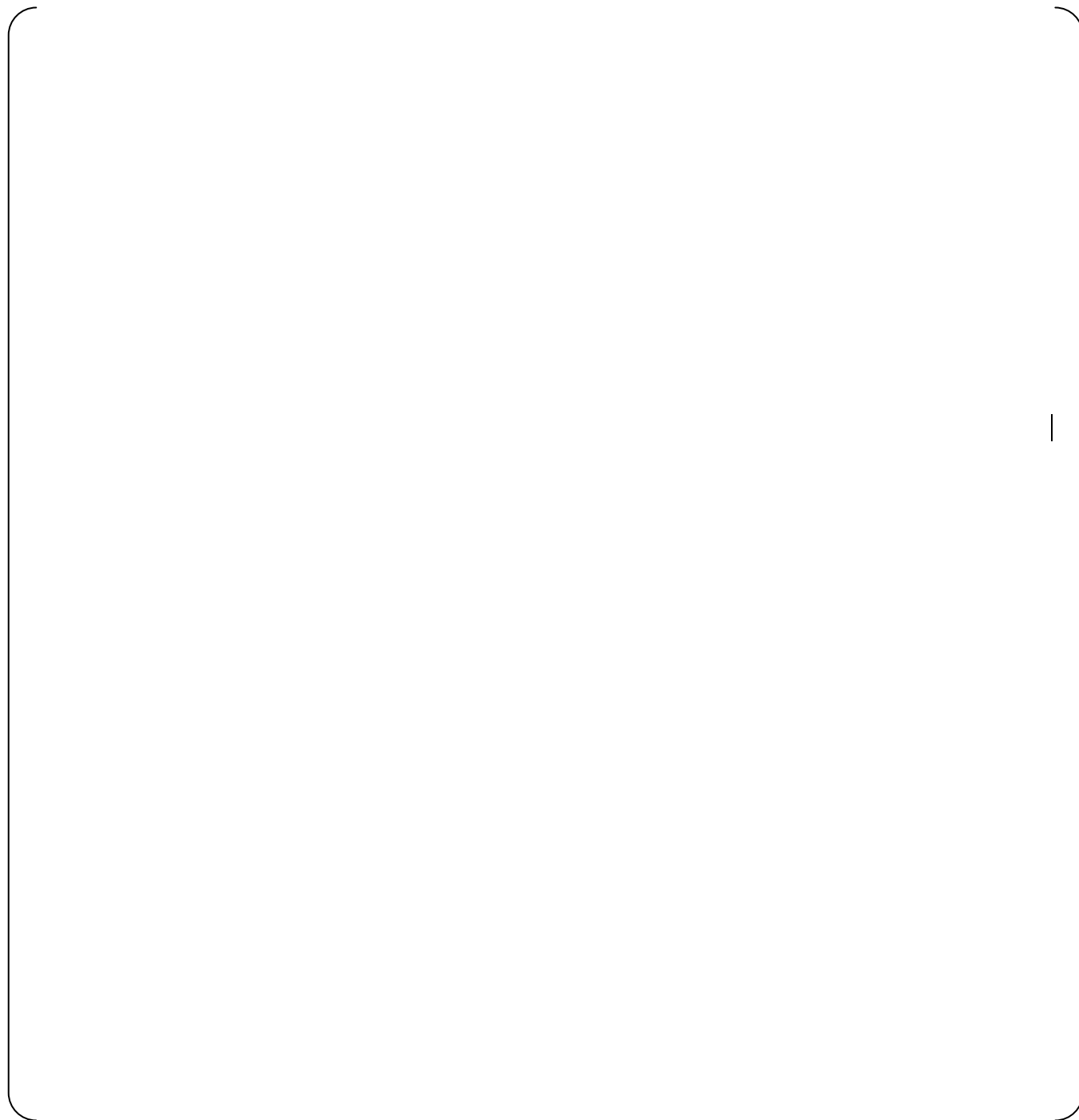

Table 3.7-1 Uncertainty Treatment for US-APWR (2/2)

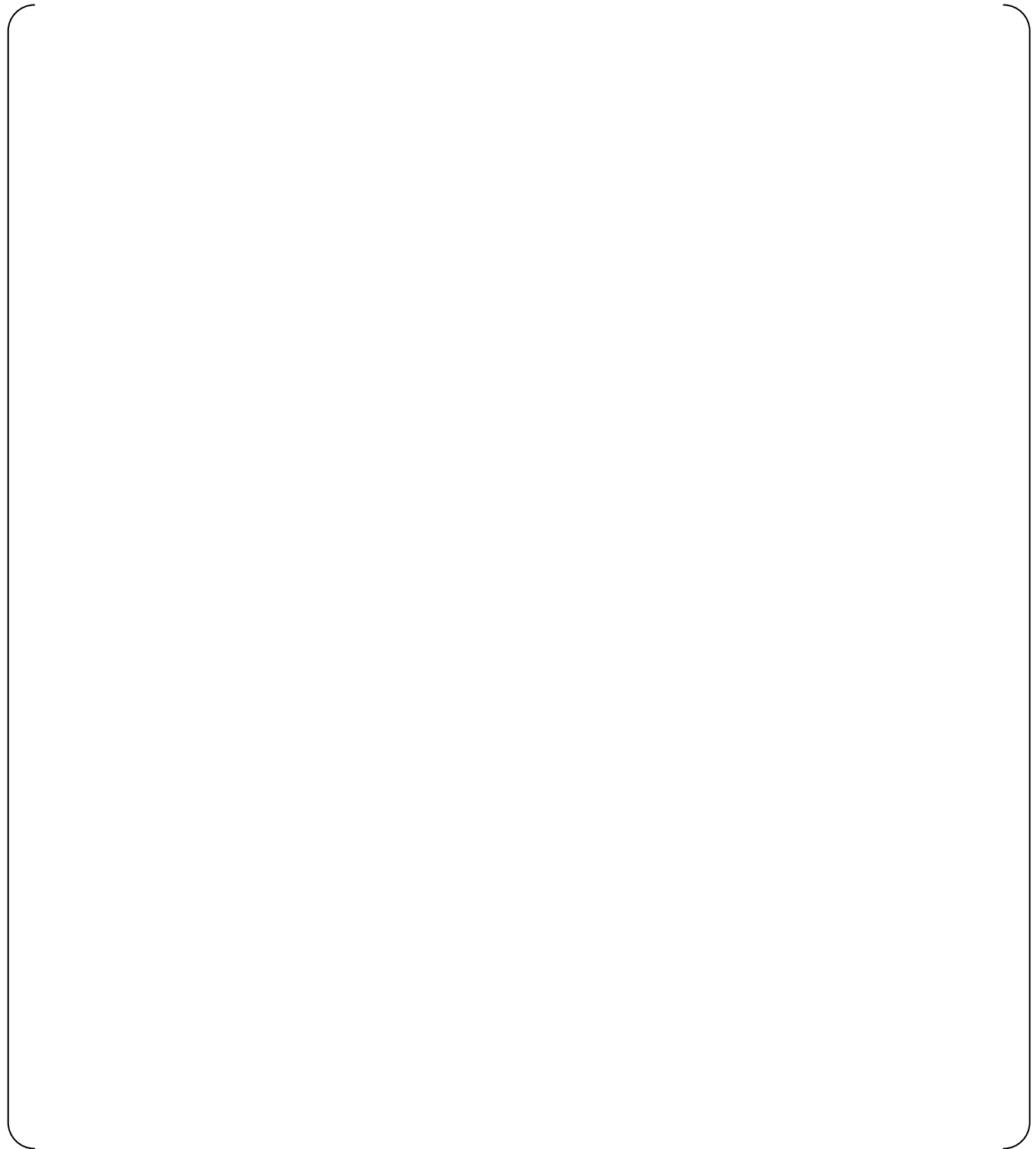

Table 3.7-2 Local Model Uncertainty Treatment for US-APWR



Table 3.7-3 Global Model Uncertainty Treatment for US-APWR



4.0 CONCLUSIONS

This report provides an assessment of the WCOBRA/TRAC code that was approved by the NRC for the Westinghouse-design 2-,3- and 4- Loop PWRs (Ref.1, 6) , and the CE-design PWR, the AP600 (Ref.2) , and the AP1000 (Ref.3) Design Certifications with the purpose to determine the applicability and appropriateness of its use for Design Certifications of the US-APWR.

The US-APWR design features that need to be separately evaluated have been identified, as the advanced accumulator DVI and NR improved design. It can be confirmed that the WCOBRA/TRAC code has applicability to the analysis US-APWR LBLOCA transient with minor modifications for the improved features of the US-APWR. The applicability of the WCOBRA/TRAC(M1.0) code for the US-APWR was evaluated successfully based on the CSAU approach using the PIRT.

The sample calculation of the LBLOCA transient by the WCOBRA/TRAC(M1.0) code using typical input data of the US-APWR was performed to demonstrate the capability of the WCOBRA/TRAC(M1.0) code for the transient of the US-APWR.

This report also described that the ASTRUM methodology, which includes this WCOBRA/TRAC(M1.0), has the same applicability to the US-APWR because the treatment of the uncertainty in the analysis of the LBLOCA transient in the US-APWR is almost the same as conventional 4 loop PWR plants.

In conclusion, the WCOBRA/TRAC(M1.0) code and the ASTRUM methodology are acceptable to provide analysis results for the US-APWR Design Control Documents (DCD). In addition, the nodding model of the WCOBRA/TRAC(M1.0) code for the US-APWR plant is acceptable for the LOCA safety analysis calculation.

5.0 REFERENCES

- 1 Dederer, S. I., et al., 1999, "Application of Best Estimate Large Break LOCA Methodology to Westinghouse PWRs with Upper Plenum Injection," WCAP-14449-P-A, Revision 1, and WCAP-14450-NP-A, Revision 1 (Non-Proprietary).
- 2 Final Safety Evaluation Report Related to Certification of the AP600 Standard Design, NUREG-1512, August 1998.
- 3 Final Safety Evaluation Report (FSER) for the Westinghouse AP1000 Advanced Reactor Design, September 20, 2004.
- 4 T. Ogino, et al. "The Advanced Accumulator", MUAP-07001-P (R4), Mitsubishi Heavy Industries, 2011
- 5 M.E., Nissley, et al., "Realistic Large Break LOCA Evaluation Methodology Using Automated Statistical Treatment of Uncertainty Method (ASTRUM)", WCAP-16009-P-A, January 2005
- 6 Bajorek, S. M., et al., 1998, "Code Qualification Document for Best Estimate LOCA Analysis," WCAP-12945-P-A, Volume 1, Revision 2, and Volumes 2 through 5, Revision 1, and WCAP-14747 (Non-Proprietary).
- 7 Wilson & Boyack, 1998 G.E. Wilson and B.E. Boyack, "The Role of the PIRT Process in Experiments, Code Development and Code Applications Associated with Reactor Safety Analysis," Nucl. Eng. Des. 186 (November 1998), pp. 23–37
- 8 Boyack, B., et al., "Quantifying Reactor Safety Margins: Application of Code Scaling Applicability, and Uncertainty (CSAU) Evaluation Methodology to a Large Break, Loss of Coolant Accident," NUREG/CR-5249, 1989
- 9 "Compendium of ECCS Research for Realistic LOCA Analysis," 1987, NUREG-1230.
- 10 "Measurement Uncertainty", ANSI/ASME PTC 19.1, 1985.
- 11 Bjomard, T. A. & Griffith, P., 1977, "PWR Blowdown Heat Transfer," Thermal and Hydraulic Aspects of Nuclear Reactor Safety, ASME, New York, Vol. 1, pp. 17-41.
- 12 T. Shimomura, et al., "Fuel System Design Criteria and Methodology", MUAP-07008-P, Mitsubishi Heavy Industries, 2007
- 13 "GOTHIC Containment Analysis Package User Manual, Version 7.2a(QA)," NAI 8907-02 Rev 17, January 2006.
- 14 "GOTHIC Containment Analysis Package Technical Manual, Version 7.2a(QA)," NAI 8907-06 Rev 16, January 2006.
- 15 "GOTHIC Containment Analysis Package Qualification Report, Version 7.2a(QA)," NAI 8907-09 Rev 9, January 2006.
- 16 Westinghouse Research Report 75-7E9-CORL-R1, "Air/Water Mixed Flow Testing of The WEMD 93A Model Reactor Coolant Pump," February 1975.
- 17 Bordelon, F. M., et al., 1974, "SATAN VI Program: Comprehensive Space-Time Dependent Analysis of Loss-of-Coolant", WCAP-8302.
- 18 STANDARD REVIEW PLAN, NUREG-0800, "6.2.1.5 MINIMUM COONTAINMENT PRESSURE ANALYSIS FOR EMERGENCY CORE COOLING SYSTEM PERFORMANCE CAPABILITY STUDIES"
- 19 Wilks, S. S., 1941, "Determination of Sample Sizes for Setting Tolerance Limits," The Annals of Mathematical Statistics, Vol.12, pp. 91-96.
- 20 Guba, A., Makai, M., Lenard, P., 2003, "Statistical Aspects of Best Estimate Method-I," Reliability Engineering and System Safety, Vol. 80, 217-232.
- 21 Suzuta, et al. "CFD Analysis for Advanced Accumulator," MUAP-09025(R2), Mitsubishi Heavy Industries, August 2011

Appendix A Thermal Properties of Nuclear Fuel Rods

A-1 Fuel Thermal Conductivity

The US-APWR fuel type (UO₂ pellet, 17x17 array, ZIRLO™ cladding) is the same as that used for conventional Westinghouse PWRs. Therefore, the fuel rod modeling of WCOBRA/TRAC(M1.0) for the US-APWR in the Large Break LOCA transient is identical to that used by Westinghouse for 17x17 fuel assemblies with ZIRLO™ cladding which has been reviewed and approved by the NRC (Ref. A-1).

The WCOBRA/TRAC code already incorporates the thermal properties of nuclear fuel. The fuel initial temperature and uncertainty are calculated by the fuel design code. Since the stored energy of high burn-up fuel is affected when taking into account the thermal conductivity degradation with burn-up, it is preferable to use a model that has the thermal conductivity degradation with burn-up. Therefore, fuel thermal conductivity is incorporated using the same model as in Mitsubishi's FINE fuel design code (Ref. A-2), which is shown below.

Uncertainty of the fuel thermal conductivity has already been partially considered in the stored energy uncertainty in ASTRUM. The same treatment of the stored energy uncertainty in the ASTRUM methodology can be applied to the US-APWR fuel.

The thermal conductivity of 95% TD UO₂ fuel is determined by the following expression, which is derived from Mitsubishi's fuel design code. It takes into consideration the degradation effect with burn-up (Ref. A-3).

$$k_{UO_2,95} = \frac{1}{A + \beta \cdot BU + B \cdot T} + C \cdot T^3$$

$k_{UO_2,95}$: Thermal conductivity for 95% TD fuel (W/cm-K)
BU	: Burn-up (MWd/kgUO ₂)
T	: Temperature (°C)
A	=11.8
B	=0.0238
C	=8.775x10 ⁻¹³
β	=0.35

Correction for density is based on Bakker's equation (Ref. A-4).

$$k_{UO_2} = k_{UO_2,95} \left(\frac{f_{TD}}{0.95} \right)^{1.7}$$

k_{UO_2}	: Thermal conductivity (W/cm-K)
f_{TD}	: Fraction to theoretical density

These functions are coded into WCOBRA/TRAC as a new routine, TCONF. The thermal conductivity is calculated in subroutine SSTEMP and TEMP. Subroutine TCONF is called from there.

A-2 References

- A-1. Davidson, S. L. and Nuhfer, D.L., "VANTAGE+ Fuel Assembly Reference Core Report", WCAP-12610, June 1990 (PROPRIETARY)
- A-2 Shimomura, T., et al., "Fuel System Design Criteria and Methodology", MUAP-07008-P Rev.2, Mitsubishi Heavy Industries, July 2010
- A-3. Wiesenack, W., "Assessment of UO₂ Conductivity Degradation Based on In-Pile Temperature Data", ANS 1997 International Topical Meeting on LWR Fuel Performance, March 1997, Portland, Oregon
- A-4. Bakker, K. et al., "Determination of a Porosity Correction Factor for the Thermal Conductivity of Irradiated UO₂ Fuel by Means of the Finite Element Method", Journal of Nuclear Materials, 226, 1995, pp.128-143

Appendix B Advanced Accumulator Model Built into WCOBRA/TRAC

B-1 Advanced Accumulator Model

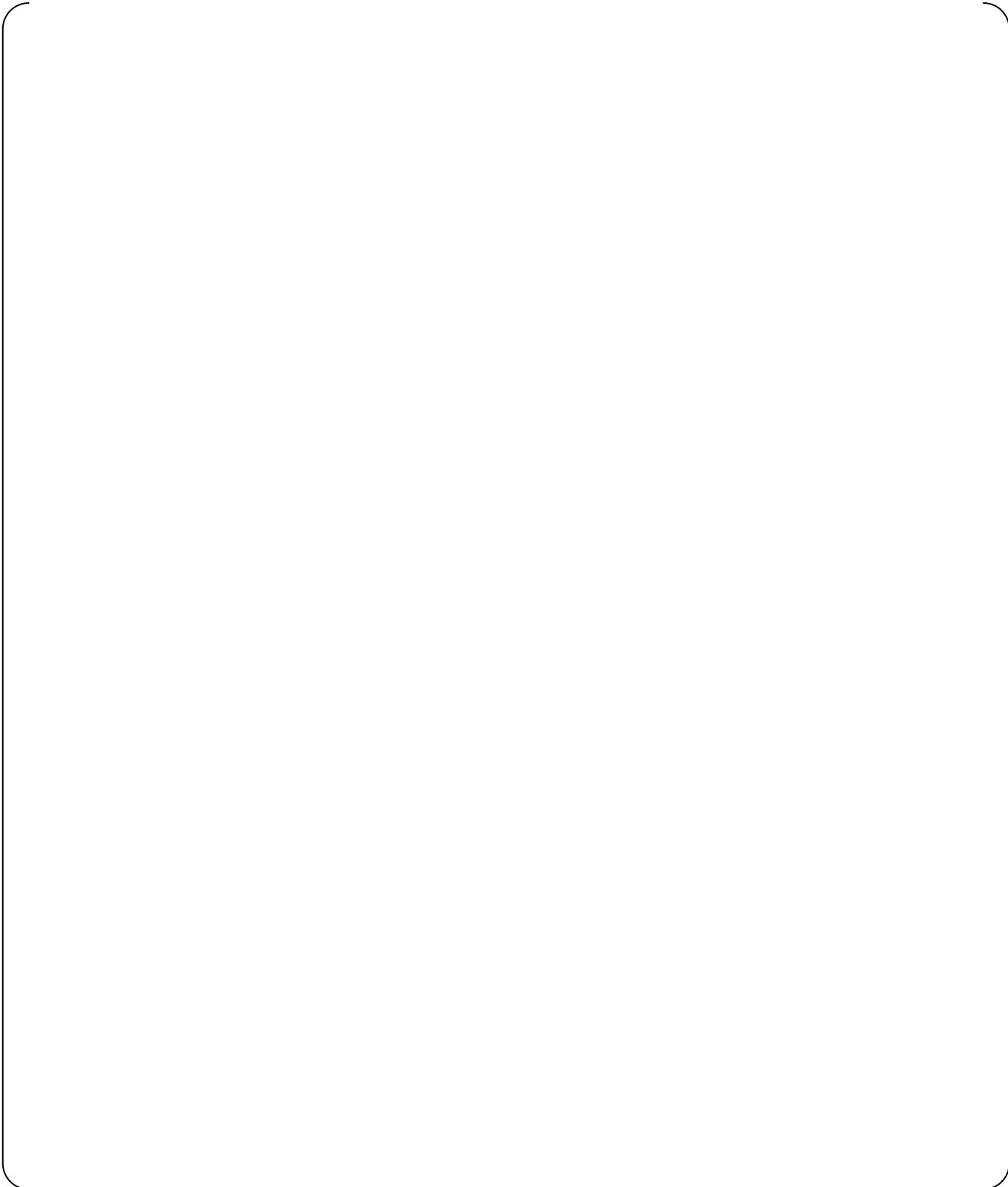

B-2 References

- B-1 Bajorek, S. M., et al., 1998, "Code Qualification Document for Best Estimate LOCA Analysis," WCAP-12945-P-A, Volume 1, Revision 2.
- B-2 "COBRA/TRAC - A Thermal-Hydraulics Code for Transient Analysis of Nuclear Reactor Vessels and Primary Coolant Systems, Programmers' Manual", NUREG/CR-3046, PNL-4385, vol.5 R4, Mar. (1983).
- B-3 Suzuta, et al. "CFD Analysis for Advanced Accumulator," MUAP-09025(R2), Mitsubishi Heavy Industries, August 2011
- B-4 T. Ogino, et al. "The Advanced Accumulator", MUAP-07001-P (R4), Mitsubishi Heavy Industries, 2011



Figure B-1 ACC Nodalization

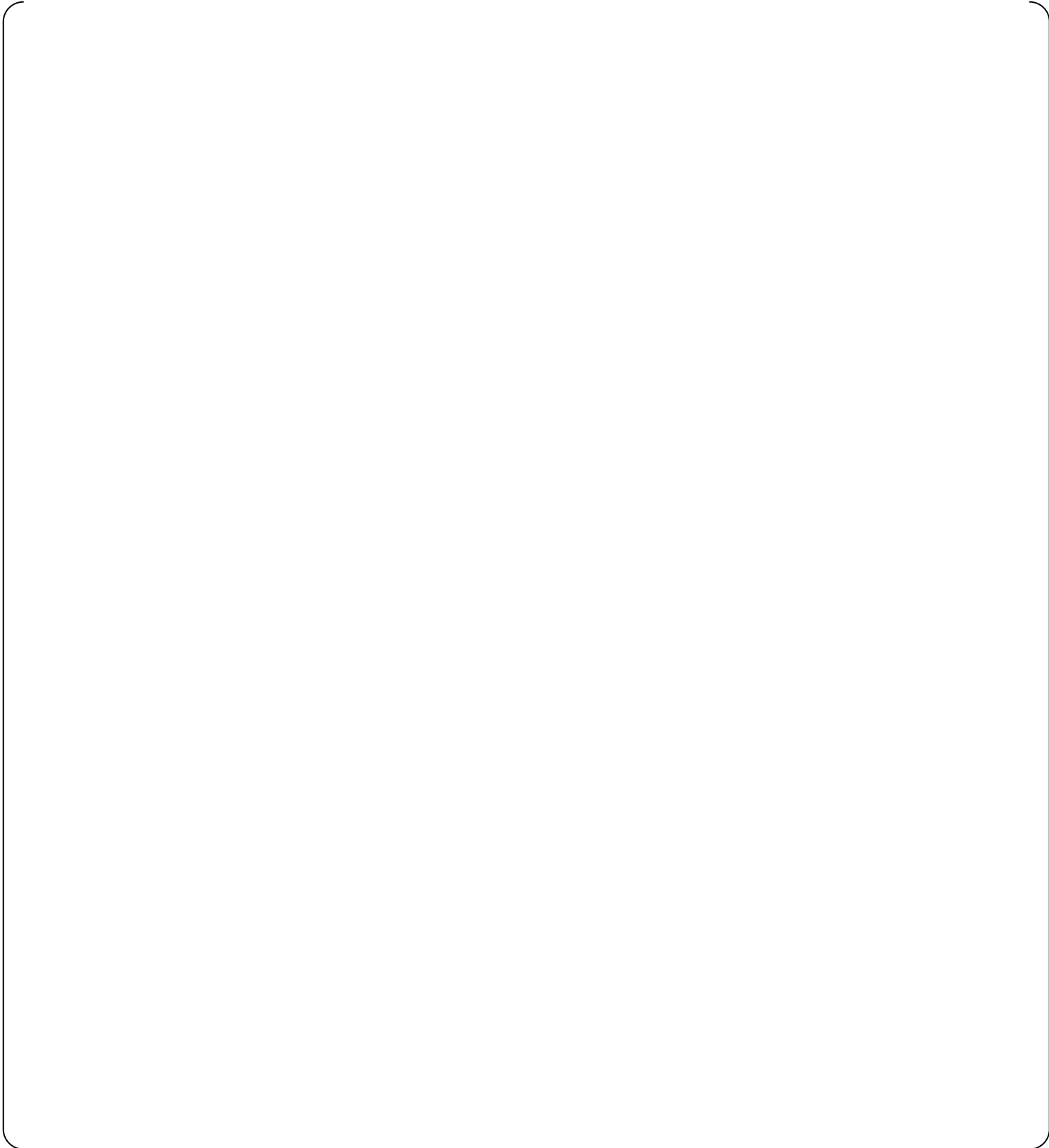

Figure B-2 Flow Resistance Calculation Diagram in Subroutine ACCUM1