

**INDIAN POINT
IMPINGEMENT STUDY REPORT
FOR THE PERIOD
1 JANUARY
THROUGH
31 DECEMBER**

NOVEMBER

Prepared for
**CONSOLIDATED EDISON COMPANY
OF NEW YORK, INC.**

4 Irving Place
New York, New York 10003

by



**TEXAS INSTRUMENTS INCORPORATED
ECOLOGICAL SERVICES**

**P.O. Box 5621
Dallas, Texas 75222**

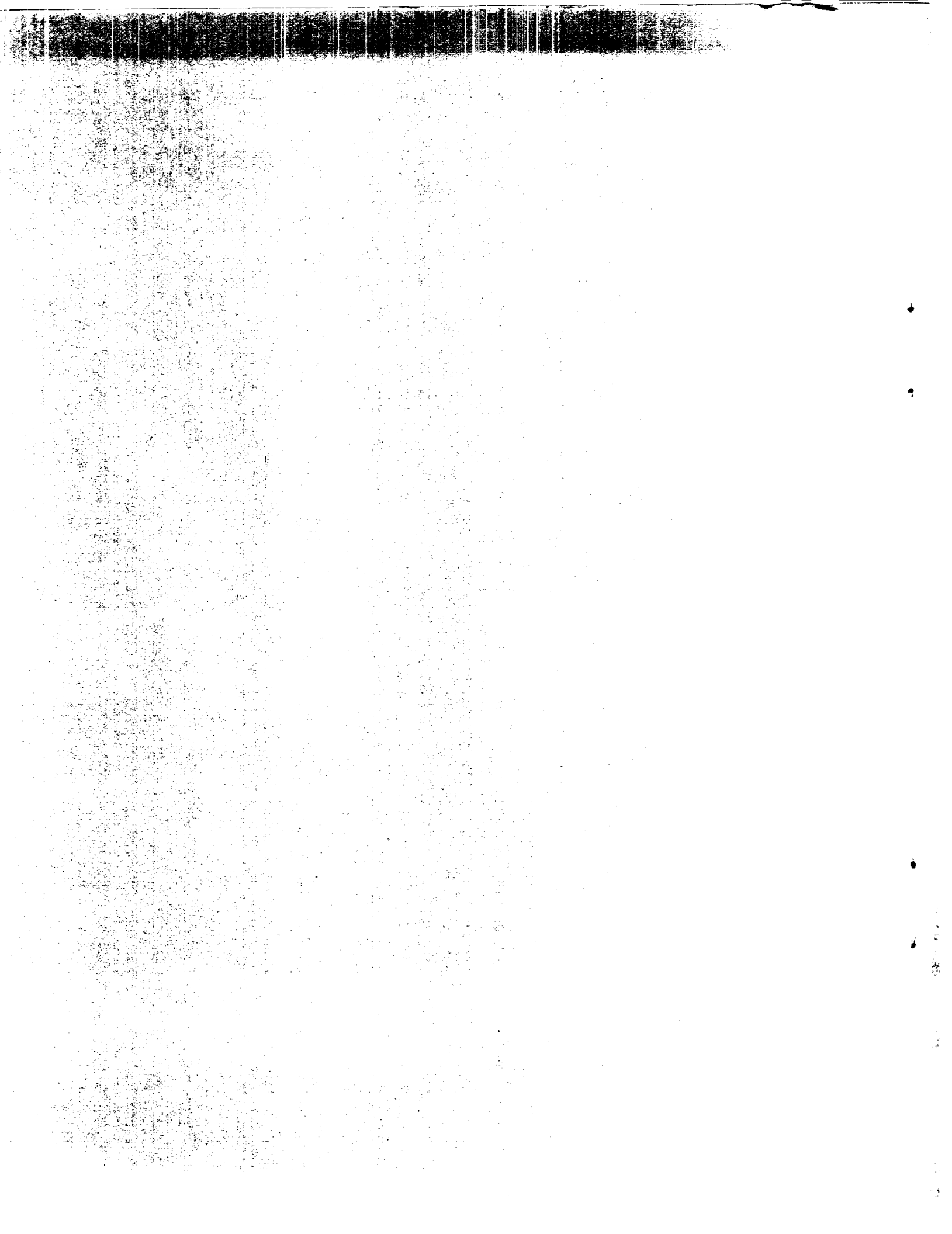



INDIAN POINT IMPINGEMENT STUDY REPORT
FOR THE PERIOD
1 JANUARY 1975-31 DECEMBER 1975

November 1976

Prepared for
CONSOLIDATED EDISON COMPANY OF NEW YORK, INC.
4 Irving Place
New York, N.Y. 10003

Prepared by
TEXAS INSTRUMENTS INCORPORATED
Ecological Services
P.O. Box 5621
Dallas, Texas 75222

Copyrighted © November 1976
By Consolidated Edison Company
of New York, Inc.



FOREWORD

Texas Instruments Incorporated (TI), under contract with Consolidated Edison Company of New York, Inc. (Con Edison), has conducted impingement studies at Indian Point since 15 June 1972 to:

- Determine factors influencing impingement
- Provide data to assess Indian Point impingement's biological impact on fish populations of the Hudson River
- Evaluate methods for reducing impingement

This is a progress report on the analyses and interpretations of impingement monitoring data collected at Indian Point from 1 January through 31 December 1975.

In addition to meeting the specific objectives, the impingement monitoring and testing program has provided data for other aspects of the Hudson River ecological study:

- Collection of impinged fish to supplement samples collected with other fishing gear used in the study of population dynamics
- Assessment of physical, chemical, temporal, and species variables associated with vulnerability to plant impact



TABLE OF CONTENTS

Section	Title	Page
	FOREWORD	iii
I	INTRODUCTION	I-1
	A. DESCRIPTION AND LOCATION OF PLANT INTAKES	I-1
	B. PROGRAM TASKS	I-4
II	SUMMARY	II-1
III	IMPINGEMENT MONITORING AND QUANTIFICATION	III-1
	A. INTRODUCTION	III-1
	B. IMPINGEMENT COLLECTION, LABORATORY WORKUP, RATE DETERMINATION	III-1
	1. Collection Methods	III-1
	2. Laboratory Workup	III-2
	3. Rate Determination	III-3
	4. Results	III-4
	C. COLLECTION EFFICIENCY TESTS	III-5
	1. Methods	III-5
	2. Results	III-9
	D. LENGTH/WEIGHT RELATIONSHIP	III-13
	1. Methods	III-13
	2. Results	III-15
IV	ENVIRONMENTAL VARIABLES INFLUENCING IMPINGEMENT	IV-1
	A. INTRODUCTION	IV-1
	B. METHODS	IV-1
	C. RESULTS	IV-2
V	LITERATURE CITED	V-1

APPENDIXES

Appendix	Title
A	FISH MONITORING DATA
B	WATER CHEMISTRY DATA
C	PLANT VARIABLE DATA
D	QUALITY-ASSURANCE CHECK ON TOTAL-COUNT ESTIMATE PROCEDURE



ILLUSTRATIONS

Figure	Description	Page
I-1	Indian Point Nuclear Power Generating Plants, Units 2, 1, and 3 at River Mile 42 on Hudson River	I-2
I-2	Indian Point Plant Layout	I-6
I-3	Cross Section of Unit 1 and 2 Intakes	I-7
III-1	Distribution of Fish Releases at Unit 2 Fixed Intake Screens for Impingement Collection Efficiency Tests	III-7
III-2	Release Mechanism for Artificial Impingement of Fish	III-9
III-3	Seasonal Plots of Regression Curves for Length/Weight Relationships of Fish Impinged at Unit 1 during 1975 and Fish Collected by Conventional Fishery Gear	III-19
III-4	Seasonal Plots of Regression Curves for Length/Weight Relationships of Fish Impinged at Unit 2 during 1975 and Fish Collected by Conventional Fishery Gear	III-21
IV-1	Plots of Daily White Perch Impingement Rates with Physicochemical Variables from Unit 2 Intake during 1975	IV-5
IV-2	Plots of Daily White Perch Impingement Rates with Physicochemical Variables from Unit 1 Intake during 1975	IV-9
IV-3	Plots of Daily Atlantic Tomcod Impingement Rates with Physicochemical Variables from Unit 2 Intake during 1975	IV-13
IV-4	Plots of Daily Atlantic Tomcod Impingement Rates with Physicochemical Variables from Unit 1 Intake during 1975	IV-17

TABLES

Table	Title	Page
I-1	Intake Screen Numbers for the Three Indian Point Units and Their Relative Position in the Intake Structures	I-3
III-1	Summary of Conditions for All Completed Impingement Collection Efficiency Tests Conducted at Unit 2 during 1974 and 1975	III-8



TABLES (CONTD)

Table	Title	Page
III-2	Results of Collection Efficiency Tests Conducted at Indian Point Unit 2 during 1975	III-10
III-3	Summary of 1975 Data Used in Chi-Square Test To Evaluate Effect of Screen Location on Collection Efficiency at Unit 2	III-11
III-4	Mann-Whitney Test for Collection Efficiency Differences between 60% and 100% Flow Rate at Screen 25 during 1974 and 1975	III-11
III-5	Comparison of Length/Weight Relationship of Fish Collected by Standard Fishery Gear and From Indian Point Intake Screens during 1975	III-16
III-6	Length/Weight Regression Statistics for Fish Collected at Indian Point Units 1 and 2 and from Traditional Fishery Gear in Indian Point Region during 1975	III-17
III-7	Regression Curve ANOVA for Striped Bass Collected from Hudson River and Impinged at Indian Point Unit 2 during Spring 1975	III-18
III-8	Regression Curve ANOVA for White Perch Collected from Hudson River and Impinged at Indian Point Unit 2 during Spring 1975	III-18



SECTION I
INTRODUCTION

Fish impingement can occur at any facility withdrawing water from an aquatic ecosystem and the severity of the problem is a function of various physical and biological characteristics of the system. Since Indian Point Unit 1 began operation in 1962, fish impingement has received attention from Con Edison, regulatory agencies, and the public. Fish are impinged when they are held against the intake screens by the force of water flow or by entanglement in the mesh screen. Impingement problems are unique to each site inasmuch as they are a function of the complex interaction of local species composition, life history, and condition, as well as behavioral and physiological response to variations in the physicochemical character of the organism's environment. To evaluate the causes, impact, and potential solutions to the problem, one must have a basic understanding of the spatiotemporal distribution and movements of species in the area, impingement patterns, relationship between fish location and the character of the aquatic environment, function and design of intake structures and operating characteristics of the plant. Information on these factors can be found in Texas Instruments reports (TI, 1975abc) related to various aspects of the Hudson River ecological study, and prior to 1972 a history of fish impingement at Indian Point can be found in Appendix BB of the Applicant's Environmental Report for Unit 3.

A. DESCRIPTION AND LOCATION OF PLANT INTAKES

The Indian Point nuclear power-generating plant (Figure I-1) is located on the east bank of the Hudson River estuary at river

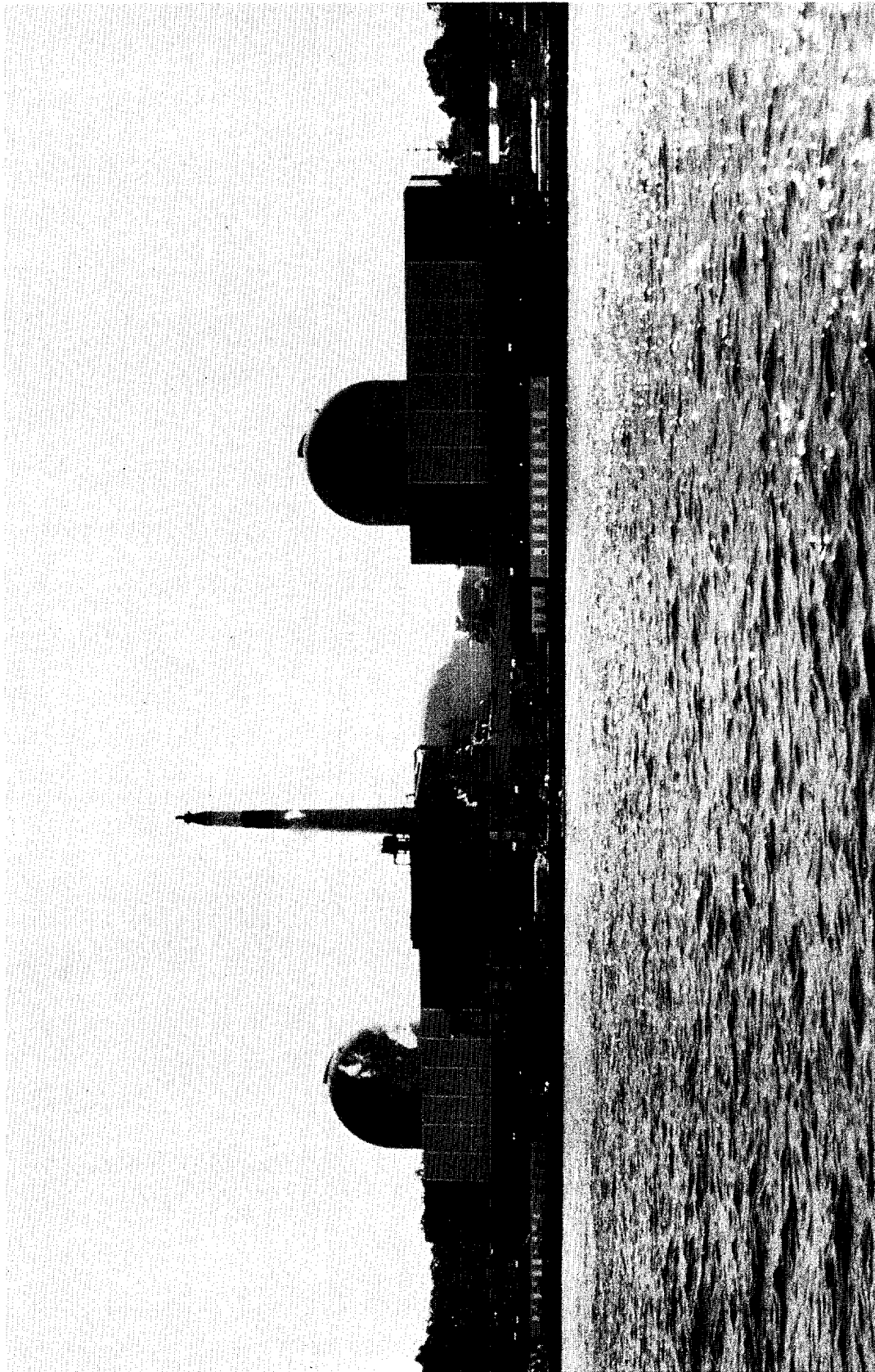

Figure I-1. Indian Point Nuclear Power-Generating Plants, Units 2, 1, and 3 (left to right) at River Mile 42 on Hudson River



mile (RM) 42.5 (KM 68) near Peekskill, New York. There are three nuclear reactors (Units 1, 2 and 3) and associated apparatus for power generation (Figure I-2). The licensed generating capabilities for Units 1 and 2 are 265 MW(e) and 873 MW(e) respectively; the capacity of Unit 3, expected to begin operation in 1976, is 1033 MW(e). All three units will have a combined water-pumping capacity of 2,058,000 gallons per minute (gpm) [7700 cubic meters per minute (m^3/min)]. Unit 1 has two 140,000-gpm ($530-m^3/min$) circulating pumps, each drawing water through two associated intake bays; three service pumps with a combined capacity of 19,000 gpm ($72 m^3/min$) draw water from each circulator forebay. Table I-1 summarizes the intake screen numbering system and the relative location of each screen. Units 2 and 3 have six 140,000-gpm ($530-m^3/min$) circulating pumps each, and each withdraws water through a separate intake bay; both Units 2 and 3 have service water pumps with a total unit capacity of 30,000 gpm ($114 m^3/min$) which draw through separate service water intake bays located in the middle of each unit's intake structure.

Table I-1
Intake Screen Numbers for the Three Indian Point Units
and Their Relative Position in the Intake Structures

	Unit	Screen Numbers						
		North				South		
North	II	26	25	24	27	23	22	21
	I	14	13	12	11			
South	III	36	35	34	37	33	32	31



Units 1 and 2 have fixed screens at the entrance to the intake bays and vertical traveling screens behind the fixed screens (Figure I-3). Unit 3 has only vertical traveling screens located at the entrance to the intake bays. All screens are 0.375-in. (9.5-mm) square mesh.

B. PROGRAM TASKS

The scope of work for the 1975 Indian Point impingement program was divided into three major objectives designed to develop a data base with which to evaluate impact and refine the knowledge of the Indian Point impingement problem.

Objective 1 was to monitor fish collected at Indian Point Units 1 and 2 intakes and record any impingement-related plant operating and river conditions. This required the collection, identification, and enumeration of fish from all screen washes and determination of length/weight relationships for striped bass, white perch, and Atlantic tomcod. Pertinent plant operational data (circulator and air curtain duration and head loss) were recorded for use in determining impingement rates. These data are reported in Section III. Also monitored daily were intake and effluent physicochemical factors (conductivity, temperature, and dissolved oxygen) which may influence impingement. These findings are reported in Section IV.

Objective 2 was to provide data with which to evaluate the biological significance of fish impingement at Indian Point. To obtain such data, all collected striped bass, white perch, and Atlantic tomcod were examined for tags and marks to identify individuals released



in conjunction with the mark/recapture and hatchery programs. Population estimates, survival, impact estimates, and fish-movement patterns derived from these data will be reported in the appropriate year class, hatchery, and Indian Point annual reports.

Objective 3 was to determine the percentage of impinged fish that are not collected at Indian Point Unit 2. Studies initiated in 1974, which indicated the potential for loss of impinged fish before collection, were continued as part of Objective 3. The results are included in Section III.

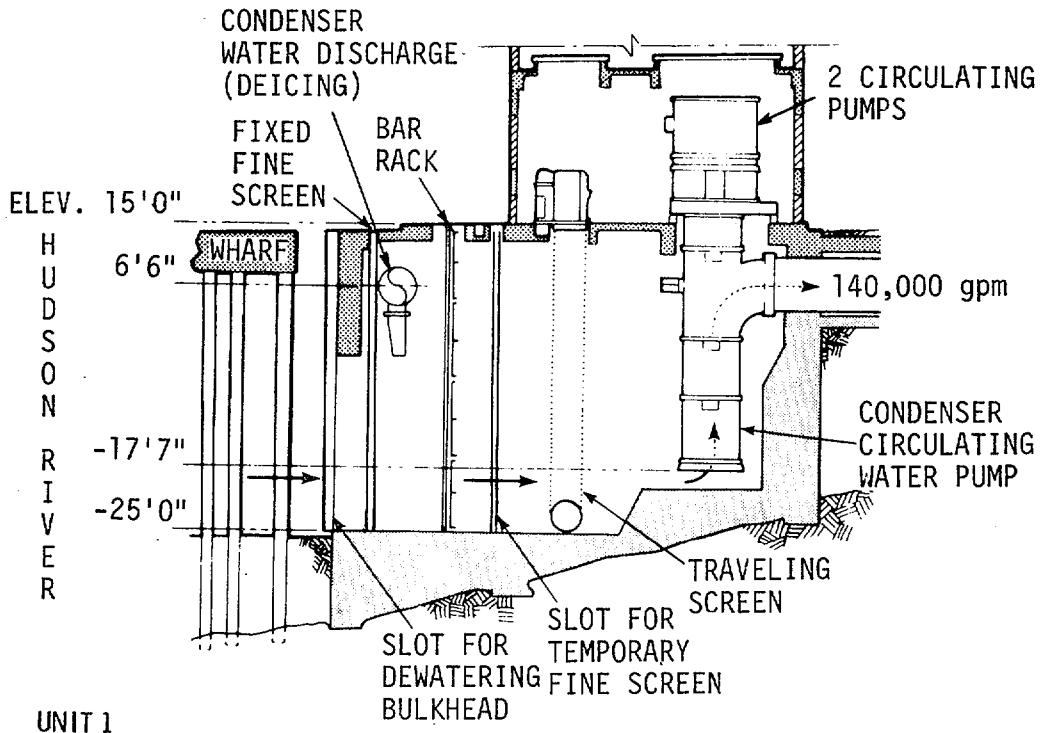

UNIT 1

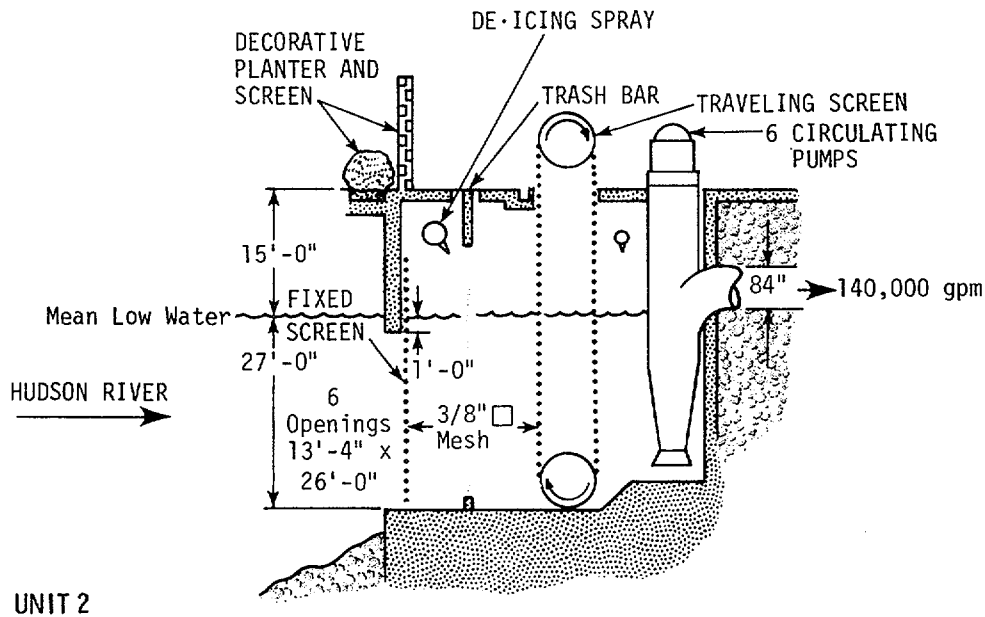

UNIT 2

Figure I-3. Cross Sections of Unit 1 and Unit 2 Intakes at Indian Point Nuclear Generating Station. (Courtesy of Consolidated Edison Company of New York)



SECTION II

SUMMARY

The impingement phenomenon at Indian Point Units 1 and 2 was quantified by washing the intake screens daily and enumerating and identifying the fish collected.

- Unit 1 yielded 50,097 fish weighing 560 kg (1235 lb). At Unit 2, there were 646,432 fish weighing 3607 kg (7953 lb). The total was 696,529 fish, approximately 228,000 less than in 1974.
- The major portion of impingement collection throughout the year was composed of the young-of-the-year and yearlings of the several resident and anadromous species that use the Hudson River estuary as a spawning and nursery area. Young-of-the-year white perch dominated impingement collection at both Units 1 and 2, representing 85% and 40% of the total number respectively. No other species composed more than 5% of Unit 1 impingement. Young-of-the-year striped bass composed <2% of the collection at both Units. Blueback herring, bay anchovy, and Atlantic tomcod were the species most numerous impinged at Unit 2 during summer and fall. Their impingement was apparently coincident with spawning movements of the adults and the use of the estuary as a nursery by the juveniles.

Experiments initiated in 1974 to evaluate the efficiency of collection procedures by artificial impingement of marked fish on the fixed screens were continued in 1975.



- These tests demonstrated that a significant number of impinged fish were lost before collection and that screen location and flow rate (60% vs 100%) did not consistently affect the efficiency of the collection procedure.
- The 1975 mean recovery rate with the air curtain operating at the intakes was 17%, ranging from 2% to 45%; the 1974 mean with the air curtain on was 12%. Only one test without the air curtain was successfully completed; therefore, mean recovery rates could not be calculated and no statistical analysis could be conducted.

Efficiency tests conducted without backwashing the fixed screens as they were raised verified the assumption that test organisms were initially impinged on the fixed screens. Although the intake's structural design did not permit collection of dyed fish from the water in front of the fixed screens, observation indicated that nearly all of the dyed fish were near where they had been released on the screen.

The variability and erratic nature of the efficiency data preclude quantifying the level of collection efficiency at this time. Until more data are available, test results must be considered preliminary and should not be used as a correction factor to adjust impingement estimates.

Seasonal length/weight relationships were determined for impinged fish and for those captured by conventional gear. These relationships were determined for white perch, striped bass, and Atlantic tomcod.



- Generally, fish impinged at Indian Point Units 1 and 2 weighed less at a specific length than those collected from the river by traditional fishery gear.

Analysis of variance, error mean squares, slope and intercept differences, and plots of regression curves were used to determine if length/weight relationships of impinged fish and fish collected by other gear differed. Differences between results from Units 1 and 2 during the same season confounded comparison of regression lines. These differences may have been an artifact of the length of time fish were on the intake screens, the rate of deterioration, and uptake or loss of water by the fish before collection.

Conductivity as an indicator of salt front movement showed a strong relationship to impingement.

- When the salt front moved through the Indian Point region, the magnitude of impingement increased. Atlantic tomcod impingement peaks generally preceded conductivity peaks, whereas white perch impingement increased as the salt front retreated downriver from Indian Point. Peak catches of white perch and Atlantic tomcod by beach seines, bottom trawls, and epibenthic sleds in long river surveys were associated with the leading edge of the salt front. This may have accounted for the impingement increases.

There was no consistent relationship between impingement and daily temperature or dissolved-oxygen fluctuations. The effect of seasonal temperature trends on fish distribution between shallow beach areas and the deeper channel was reflected by shifts in species composition of the impinged fish during winter, summer, and late fall.



SECTION III

IMPINGEMENT MONITORING AND QUANTIFICATION

A. INTRODUCTION

To monitor impingement magnitude, seasonal occurrence of species, size composition of collections, and conditions of striped bass, white perch, and Atlantic tomcod at Indian Point in 1975:

- The screens were washed daily
- Fish were identified, counted, and subsampled for length and weight
- Impingement rates were calculated

The efficiency of the collection process was examined through the recovery of artificially impinged marked fish, and these data were analyzed in conjunction with 1974 collection-efficiency data. The power plant, considered as an additional gear type for the fisheries mark/recapture program, provided fish for use in population estimates and direct impact assessment.

B. IMPINGEMENT COLLECTION, LABORATORY WORKUP, RATE DETERMINATION

1. Collection Methods

The fixed screens at Indian Point Units 1 and 2 were washed with high-pressure water jets daily between 0800 and 1200. Circulator flow drew a portion of the fish and debris from the screens into the forebay where they were reimpinged on traveling screens; these were washed individually and the wash water drained through a sluice



containing a 0.375-in. square mesh collection screen. To assure complete rotation of the screen, approximately 20 minutes was allowed for each screen wash.

Fish and debris were removed from the collection screens with hand or scap nets. If debris load was heavy, it was necessary to stop the washing process and drain the sluice several times to prevent loss of fish. Unscheduled screen washings were made to alleviate head loss due to high debris loading or impingement. When TI was notified of their occurrence, these additional washes and fish collections were treated in the same manner as the scheduled daily washes.

2. Laboratory Workup

During 1975, collections of the key species (white perch, striped bass, and Atlantic tomcod) were counted while the numbers in collections of other species was estimated by subsampling. Total numbers and weights of striped bass, white perch, and adult Atlantic tomcod were recorded daily. Total count and weight were also recorded for young-of-the-year Atlantic tomcod during the winter marking period. These three species were individually examined for marks and tags. For each remaining species (which included juvenile tomcod after the tomcod marking season), 100 fish were randomly selected from collections greater than 100 in order to determine the number/weight relationship for estimation of total number from total weight:

$$\hat{N} = \frac{Wn}{w}$$

where

\hat{N} = estimated total number

W = measured total weight

w = measured weight of subsample

n = subsample size = 100



When species counts were less than 100, all fish were counted. The subsampling was sufficient to insure exact counts of infrequently impinged species, this technique was subjected to three quality-assurance checks during 1975 (reported in Appendix D).

3. Rate Determination

Impingement rates were determined from impingement collection estimates and volume of water pumped during the collection period. Performance engineers at Indian Point provided TI with circulator flow rates and operating duration data (i.e., the time when each circulator was turned on or off). With these data, total volume of water circulated during the sampling period and average impingement rate (number of fish per million cubic meters [10^6 m^3] of water pumped) were calculated and this was used to represent catch per unit effort. Average weekly, monthly, seasonal, and annual impingement rates for each unit were obtained by dividing the sum of daily impingement numbers by the sum of daily flow volumes for the specific period. Weekly rates were reported for intervals of 7 days beginning 1 January (Appendix Table A-1); calendar months were used for monthly rates.

Water temperature was used to determine seasonal delineations as follows:

<u>Season</u>	<u>Dates</u>	<u>Temperature Range</u>
Winter	Jan 1-Apr 10	Low and relatively constant (0.5-7.0° C)
Spring	Apr 11-Jun 17	Rising (7.1-24° C)
Summer	Jun 18-Sep 17	High and relatively constant (24.1-27° C)
Fall	Sep 18-Dec 31	Falling (24-2.0° C)



4. Results

Young-of-the-year white perch dominated impingement collections during 1975: 85% of 50,097 fish at Unit 1 (560 kg [1235 lb]); 40% of 646,432 fish at Unit 2 (3607 kg [7953 lb]). White perch composed 91% of impingement collections at Unit 2 through May. The majority of white perch impingement occurred in the spring when the species was concentrated in deeper water and influenced by movement of the salt front (Section IV).

During summer and fall at Unit 2, the species most numerous impinged were blueback herring (24% annually), bay anchovy (15.7% annually), and Atlantic tomcod (12.7% annually). Their impingement was related to movement of young-of-the-year fish within the estuary. Young-of-the-year blueback herring were a major part of impingement when they moved downstream in late summer and fall after utilizing the river as a nursery area during summer. Bay anchovy were impinged while using the Indian Point region as a feeding ground in summer. During summer, Atlantic tomcod juveniles were impinged in high numbers in association with summer salt intrusions (Section IV). In December, spawning adults accounted for most Atlantic tomcod impingement.

The difference in collections between units was a consequence of reduced operation at Unit 1 during 1975: the circulators did not operate from September through December and only one circulator operated consistently from January through June. Summer operation was very irregular. No species other than white perch composed more than 5% of Unit 1 impingement; striped bass accounted for 2%.



Appendix A summarizes numbers and weights of impinged fish by time period and presents impingement rates for the same time periods. Plant operational data appear in Appendix C.

C. COLLECTION EFFICIENCY TESTS

1. Methods

Dead fish marked with dyes were released at the Unit 2 fixed screens to estimate the percentage of fish impinged on the fixed screens which were not recovered from the traveling screens during the collection process. Marked fish were released in such a way as to reflect the temporal and spatial distribution of impingement which might influence collection efficiency. The use of tags or fin clips could have potentially biased results due to losses of these marks on the screens or during washing. Another consideration was that the presence of a dyed fish was obvious during collection and laboratory workup. Most of the test fish were young-of-the-year white perch, although striped bass and older white perch were also used in numbers roughly proportional to their frequency in past collections. Atlantic tomcod, blueback herring, and bay anchovy could not be used in these studies because of tissue disintegration and decay during dyeing, reimpingement, and washing processes.

Since recovery may depend on impingement duration and exposure to loss factors such as scavenging and scrubbing by air-curtain currents, dead fish were distributed 1, 15, and 23 hr before the 0900



collection. Test specimens were released directly in front of screens 21, 23, 25, or 26 (See Table I-1) because recovery rates might be affected by reimpingement of lost fish on adjacent screens. Screens 21 and 26 at the ends of the Unit 2 intake structure are bounded on only one side by another intake, while intakes 25 and 23 are bounded on both sides by other intakes. Since the point on the screen where fish are impinged may influence the potential for recovery, fish were released at five locations in front of each screen in every time period (Figure III-1). Test conditions are summarized in Table III-1.

The marked fish were placed in a release mechanism consisting of a 0.25-ft x 1.0-ft (7.5-cm x 30.5-cm) tube with stoppered ends (Figure III-2); the mechanism was positioned between the air-bubbler structure and the fixed screen, < 0.5 m from the screen. To simulate the depth distribution of fish impingement reported for 1974 (TI, 1975d i.e., 70% of impingement occurred on the upper half of the screen), 50 fish were distributed on the screen; with 30 placed in the upper release points (Figure III-1) and another 10 placed at mid-screen.

The marked fish were collected during standard impingement monitoring procedures. The screen at which each fish was released, the date and time of collection, and the air-curtain status throughout the test period were recorded. Fish recaptured during these experiments were not included in daily collection records.

The recovery percentages were calculated and blocked by screen location and flow rate to evaluate these factors as sources of variation in recovery efficiency. A chi-square test was conducted on



data in a 2-x-2 contingency table to evaluate differences between collection efficiencies from screens at the end and middle of Unit 2. In addition, a Mann-Whitney test was used on combined 1974-1975 data to evaluate differences between collection efficiencies at 60% and 100% flow rate at screen 25. Only one test with the air curtain off was successfully completed in 1975. Therefore, differences between air-curtain modes could not be evaluated.

During 1975, TI examined the major assumption of efficiency tests conducted during 1974 at Indian Point: that test specimens, once released, are impinged on the fixed screen. On five occasions, 100 fish were distributed as described previously at two screens 1 hr before the fixed screen wash. With the air curtain off and no high-pressure backwash, the fixed screen was raised and dyed fish recovered by hand or net in front of the fixed screen. The location of fish on the screen and the approximate number of marked fish observed on the screen which could not be retrieved due to structural limitations were recorded.

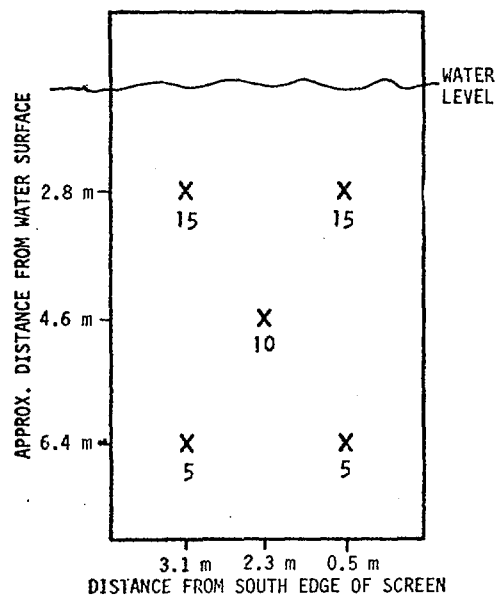

Figure III-1. Distribution of Fish Releases at Unit 2 Fixed Intake Screens for Impingement Collection Efficiency Tests (Number of fish released are indicated below release points)



Table III-1

Summary of Conditions for All Completed Impingement Collection
Efficiency Tests Conducted at Unit 2 during 1974 and 1975

Date	Releases per Screen	Total Fish Released	Air Curtain Operational Condition	Fish Condition	Flow Rate (%)
Nov 13, 1974	4	400	On	Dead	60
18	4	400	Off	Dead	60
Dec 4, 1974	4	400	On	Dead	60
4	1	100	On	Alive	60
9	4	400	Off	Dead	60
9	1	100	Off	Alive	60
Jan 25, 1975	3	300	On	Dead	60
May 14, 1975	1	100	Off	Dead	100
15	1	100	On	Dead	100
Jun 3, 1975	1	100	Off	Dead	100
5	1	100	On	Dead	100
19	3	300	On	Dead	100
23	3	300	On	Dead	100
Jul 2, 1975	1	100	On	Dead	100
Sep 10, 1975	3	300	On	Dead	100
23	1	100	Off	Dead	100
Oct 1, 1975	3	300	On	Dead	100
3	3	300	Off	Dead	100

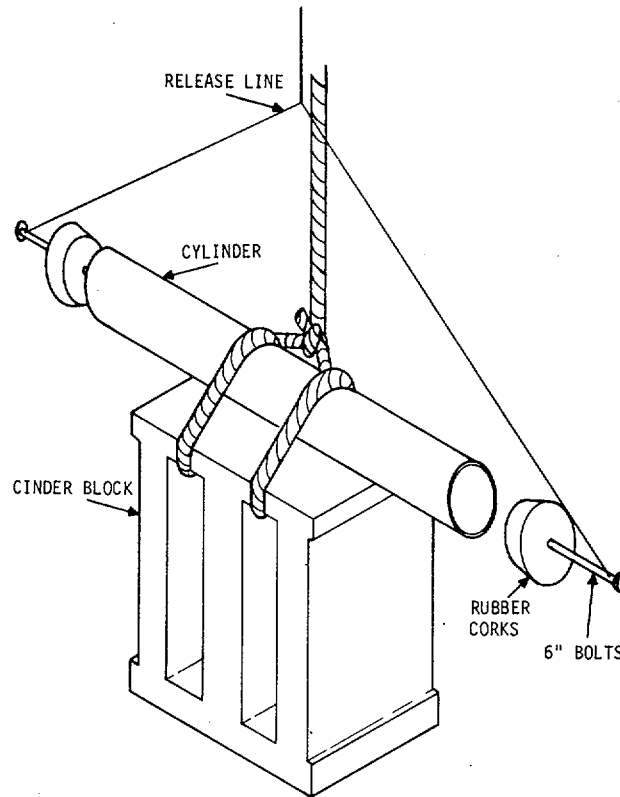

Figure III-2. Release Mechanism for Artificial Impingement of Fish

2. Results

Impingement collection efficiency tests indicated that a significant but variable bias may have existed in impingement estimates based on collections from the Unit 2 traveling screens. The mean recovery rate for 1975 tests with the air curtain on was 17%, ranging between 2% and 45% (Table III-2); the 1974 mean was 12% with the air curtain on.



Table III-2

Results of Collection Efficiency Tests Conducted
at Indian Point Unit 2 (Air Curtain On) during 1975

Date (1975)	Screen	Number Recovered from All Screens	Number Lost	% Recovered
Jun 19	22	15	135	10.00
	25	12	138	8.00
Jun 23	22	30	120	20.00
	25	15	135	10.00
Sep 10	21	68	82	45.33
	25	37	113	24.67
Oct 1	22	3	147	2.00
	26	24	126	16.00
Mean				17.00

No consistent effect of screen location was indicated by statistical analysis of these experimental results (Table III-3). The variability of screen-location effect on impingement in the 2 years was apparent from results of chi-square tests: one test was not significant ($\alpha = 0.05$) and two demonstrated significantly higher efficiency at end screens. On the other hand, interior screens recovered significantly more impinged fish than did end screens during 1974 tests.

The Mann-Whitney test indicated no significant difference ($\alpha = 0.10$) between efficiencies at 60% and 100% flow rate for combined 1974 and 1975 data (Table III-4). Because of variable screen differences, screens were not combined; only screen 25, where sufficient data existed, was used in the Mann-Whitney test.



Table III-3

Summary of 1975 Data Used in Chi-Square Test To Evaluate Effect of Screen Location on Collection Efficiency at Unit 2

Date	Screen	Recovered	Lost	χ^2
Jun 25, 1975	Interior End	14	136	3.01
		24	126	
Sep 10, 1975	Interior End	37	113	14.08*
		68	82	
Oct 1, 1975	Interior End	3	147	17.95*
		24	126	

* Significant at $\alpha = 0.05$

Table III-4

Mann-Whitney Test* for Collection Efficiency Differences between 60% and 100% Flow Rate at Screen 25 during 1974 and 1975

100% Flow		60% Flow	
% Recovery	Rank	% Recovery	Rank
8.00	1	16.00	4
10.00	3	16.50	5
24.67	6	9.33	2

*T = 4. Not significant at $\alpha = 0.10$.



Experiments verified the assumption that test organisms were impinged although the exact proportion of released fish could not be determined. The intake's structural design did not permit access for collection of marked fish from the water in front of the fixed screen when it was raised and not backwashed. Most of the dyed fish were observed on the screen as it was raised. The fish were distributed in the five patches on the screen at which they were released. As the point of impingement on the screen cleared the water surface, the fish often rolled off with debris and floated in front of adjacent screens, and some of the marked fish entered the forebay when the bottom edge of the screen was raised above the water surface.

Some fish were lost during fixed screen washing when water jets blew them back into the river and the air curtain was observed to have pushed some of the fish removed during fixed-screen washings back into the river. Based upon visual observations, the air curtain may have actively removed fish from the fixed screen and carried them into the river. Fish thus removed are either carried away by the river, impinged on the same or adjacent screens, or taken by scavenging sea gulls. The probability of reimpingement depended, in part, on screen location and tidal stage when the fish were removed from the fixed screens. Fish removed from screen 21 during ebb tide, for example, were not exposed to adjacent circulator flow and could have been carried away by river flow; fish removed from fixed screen 25 could have been reimpinged at adjacent screens during any tidal stage. Since fish usually were recovered during several subsequent washes (within 3 days



for most recovered fish), several tidal conditions and an array of other variables affected each test.

The results of this study, although indicating the potential for significant underestimation of impingement magnitude, especially during air-curtain operation, are preliminary and should not be used to quantify such bias or to compute correction factors for impingement counts. The results obtained during 1974 and 1975 indicate that recovery rates are highly variable between screens and tests due to the uncontrollable variables. It will therefore be necessary to determine several correction factors blocked on groups of variables in order to reflect these differences. In order to establish correction factors accounting for the variability observed, more tests are necessary to determine the confidence intervals for efficiency estimates and to determine those variables which affect collection efficiency. It should be noted that in addition to an efficiency correction, the survival of impinged fish lost before collection should also be taken into account.

D. LENGTH/WEIGHT RELATIONSHIP

1. Methods

The relationship between fish length and weight is an indication of condition. To describe length/weight relationship, specimens of striped bass, white perch and Atlantic tomcod were collected by beach seine and otter trawls at standard river stations in



the Indian Point region and from the Indian Point intake screens. All length/weight data were obtained from fresh fish. The three species were segregated into four total-length (TL) categories:

<u>Lower Bound (mm)</u>	<u>Upper Bound (mm)</u>
0	x
x + 1	150
151	250
251	none

where x represented the upper TL limit for the young-of-the-year age class. Individual lengths and weights were obtained for biweekly subsamples of 25 randomly selected fish of each length class.

Length/weight relationships were determined using linear regression analysis. \log_{10} transformed data were used to calculate seasonal regression lines for each species and in all subsequent tests. The straight-line equation used to describe this relationship was

$$\log W = \log a + b \log L$$

where

W = weight (g)

L = length (mm)

a = Y intercept

b = slope

The assumption of homogeneity of variance among populations was tested using Levene's test. Analysis of variance (ANOVA) was used to test for differences between regression lines for river and impinged populations if homogeneity of variance was not rejected; if homogeneity



could not be assumed, the error mean squares, slope and intercept differences, and plot of the regression curves ($W = aL^b$) were examined to determine if the two populations demonstrated the same length/weight relationship.

2. Results

Seasonal regression analyses of the length/weight relationship of fish impinged at Indian Point and collected by fishery gear from the river indicated some differences between the two groups (Tables III-5 and III-6). Only spring collections of white perch and striped bass from Unit 2 satisfied the homogeneity-of-variance assumption and could be validly tested by analysis of variance (Tables III-7 and III-8); in both cases, ANOVA indicated that the regression curves were significantly different ($\alpha = 0.05$). Regression curves for these two species collected at Unit 1, however, were equivalent to those for fish collected in fishery sampling gear. Plots of the regression curves indicated that impinged fish usually weighed less at a specific length than did fish collected at standard stations (Figures III-3 and III-4). The only exception was Atlantic tomcod: regression curves for tomcod intersect, with impinged fish weighing more at shorter lengths and less at greater lengths than fish collected by fishery gear. However, it should be noted that the tomcod regression curves were significantly different only during the spring.

These differences may be explained by several hypotheses which include deterioration of fish during the impingement process or that fish impinged at Indian Point may be in poorer condition (i.e., weigh less at a specific length) than the population as a whole. However,



differences between units during the same season confound any conclusions. Although obviously damaged or deteriorated fish were not used for these analyses, it is not known what effect duration on the screen may have on the length/weight relationship; this is a potential source of bias that must be investigated before coming to a firm conclusion on differences between the two populations sampled.

Table III-5

Comparison (Based on ANOVA and Consideration of Error Mean Square, Slope, Intercept, and Regression Plots) of Length/Weight Relationship of Fish Collected by Standard Fishery Gear and from Indian Point Intake Screens during 1975

	Species	Unit	Comparison
Spring	Striped bass	1	Equal
	Striped bass	2	Not Equal
	Atlantic tomcod	1	Not Equal
	Atlantic tomcod	2	Not Equal
	White perch	1	Equal
	White perch	2	Not Equal
Summer	Striped bass	1	*
	Striped bass	2	Not Equal
	Atlantic tomcod	1	Equal
	Atlantic tomcod	2	Equal
	White perch	1	Not Equal
	White perch	2	Not Equal
Fall	Striped bass	2	Not Equal
	Atlantic tomcod	2	Equal
	White perch	2	Equal

*Insufficient variability in lengths of impinged fish



Table III-6

Length/Weight Regression Statistics for Fish Collected at Indian Point Units 1 and 2 and from Traditional Fishery Gear in Indian Point Region during 1975

Species	Sample Location	Season	Sample Size	Y-Intercept a	Slope b	Correlation Coefficient r	Coefficient of Determination r^2	Mean Square Error
Striped bass	1	Spring	19	-5.301	3.144	0.9670	0.9350	0.1465904×10^{-1}
Striped bass	2	Spring	119	-4.526	2.743	0.9317	0.8681	0.7089279×10^{-2}
Striped bass	SS	Spring	60	-4.861	2.941	0.9904	0.9809	0.3318704×10^{-2}
Striped bass	1	Summer	15	-4.705	2.845	0.7698	0.5925	0.1874175×10^{-1}
Striped bass	2	Summer	225	-3.980	2.480	0.9737	0.9481	0.2286902×10^{-1}
Striped bass	SS	Summer	394	-4.868	2.927	0.9921	0.9843	0.3241408×10^{-2}
Striped bass	2	Fall	143	-4.988	2.984	0.9790	0.9584	0.5697385×10^{-2}
Striped bass	SS	Fall	263	-5.198	3.084	0.9924	0.9848	0.1994381×10^{-2}
White perch	1	Spring	166	-5.235	3.168	0.9925	0.9850	0.4684589×10^{-2}
White perch	2	Spring	304	-5.281	3.189	0.9954	0.9907	0.3247617×10^{-2}
White perch	SS	Spring	773	-5.361	3.243	0.9931	0.9863	0.3353660×10^{-2}
White perch	1	Summer	101	-4.700	2.880	0.9861	0.9725	0.1357968×10^{-1}
White perch	2	Summer	401	-4.990	3.023	0.9923	0.9847	0.6901835×10^{-2}
White perch	SS	Summer	426	-5.274	3.196	0.9955	0.9910	0.6274045×10^{-2}
White perch	2	Fall	407	-5.002	3.052	0.9920	0.9840	0.4130494×10^{-2}
White perch	SS	Fall	574	-5.359	3.229	0.9952	0.9905	0.1948766×10^{-2}
Atlantic tomcod	1	Spring	92	-3.383	2.124	0.9625	0.9265	0.2754765×10^{-1}
Atlantic tomcod	2	Spring	157	-4.076	2.536	0.9657	0.9325	0.3990602×10^{-1}
Atlantic tomcod	SS	Spring	274	-5.382	3.174	0.9944	0.9889	0.7181653×10^{-2}
Atlantic tomcod	1	Summer	79	-5.039	2.968	0.9723	0.9453	0.1144577×10^{-1}
Atlantic tomcod	2	Summer	310	-5.323	3.102	0.9859	0.9720	0.9628977×10^{-2}
Atlantic tomcod	SS	Summer	356	-4.930	2.924	0.9911	0.9823	0.2429702×10^{-2}
Atlantic tomcod	2	Fall	165	-5.577	3.237	0.9784	0.9573	0.6551937×10^{-2}
Atlantic tomcod	SS	Fall	276	-5.293	3.119	0.9854	0.9710	0.2617334×10^{-2}

* 1 = Unit 1
 2 = Unit 2
 SS = Fisheries standard stations



Table III-7

Regression Curve ANOVA for Striped Bass
Collected from Hudson River and Impinged at Indian Point
Unit 2 during Spring 1975

Source	Degrees of Freedom	Sum of Squares	Mean Square	F Statistic	Probability
Common line	2	0.138134	0.069067	11.82732	<0.001
Common slope	1	0.017374	0.017374	2.97515	<0.10
Error	175	1.021930	0.005840		

Table III-8

Regression Curve ANOVA for White Perch
Collected from Hudson River and Impinged at Indian Point
Unit 2 during Spring 1975

Source	Degrees of Freedom	Sum of Squares	Mean Square	F Statistic	Probability
Common line	2	0.240705	0.120353	36.20921	<0.001
Common slope	1	0.018830	0.018830	5.66530	<0.05
Error	1073	3.566453	0.003324		



STRIPED BASS

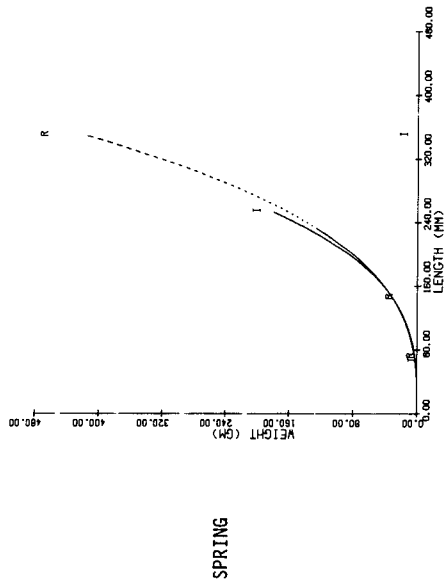

SPRING

WHITE PERCH

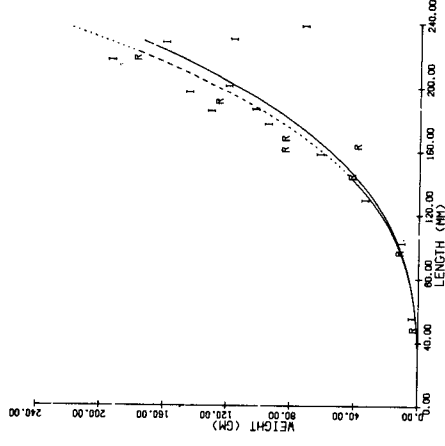

ATLANTIC TOMCOD

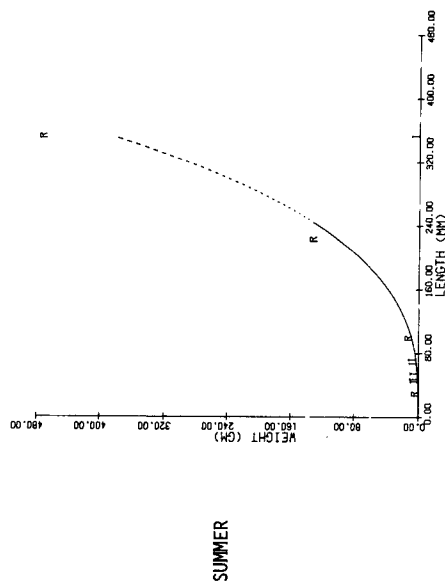
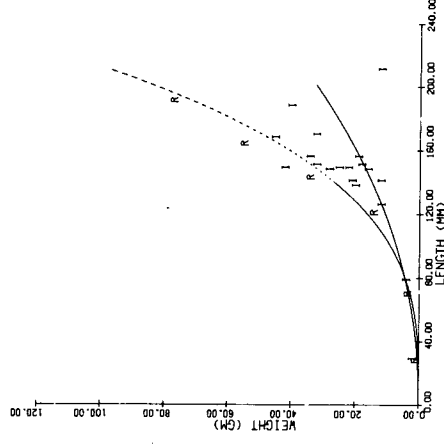

SUMMER

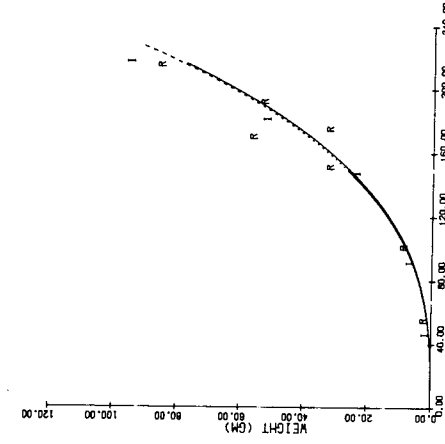
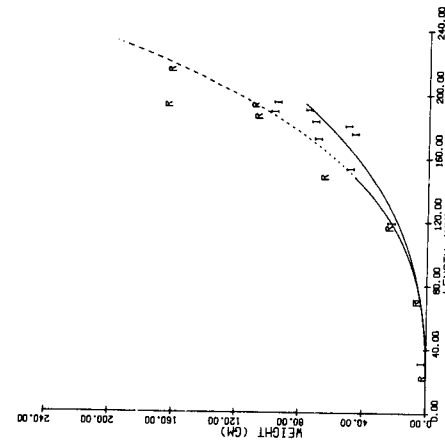

— IMPINGED FISH
--- RIVER FISH

Unit 1 was inoperational during the fall.

Figure III-3. Seasonal Plots of Regression Curves for Length/Weight Relationships of Fish Impinged (I) at Unit 1 during 1975 and Fish Collected by Conventional Fishery Gear (R)



STRIPED BASS

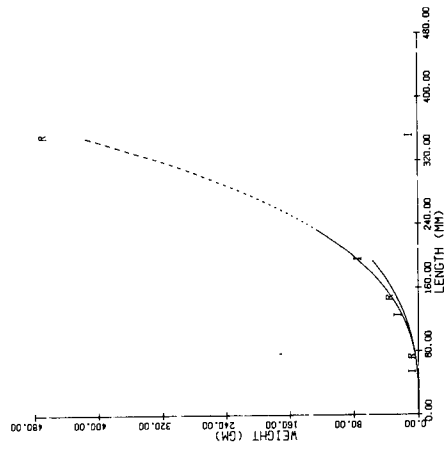

SPRING

WHITE PERCH

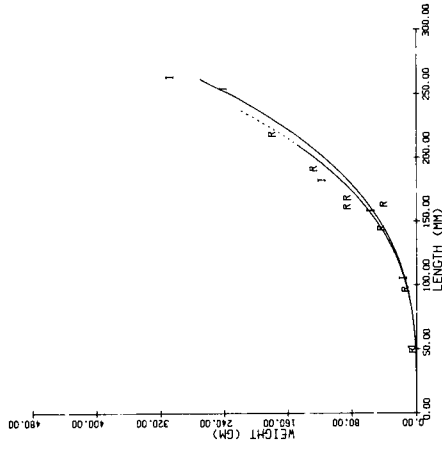

ATLANTIC TOMCOD

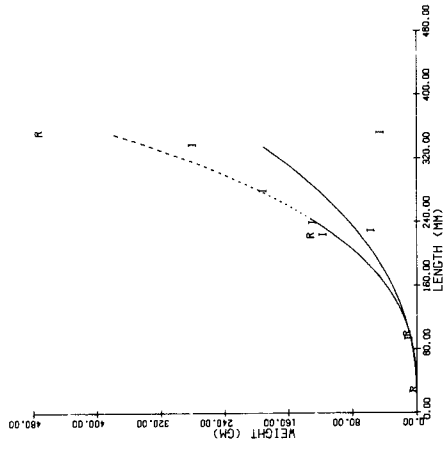
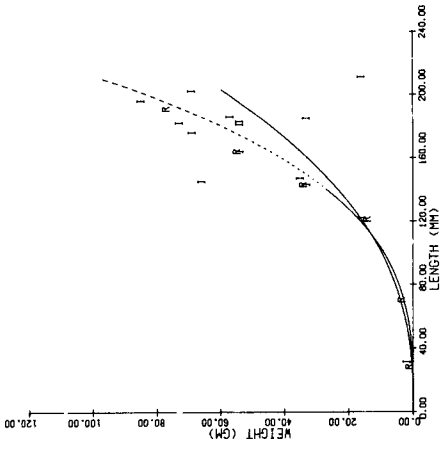

SUMMER

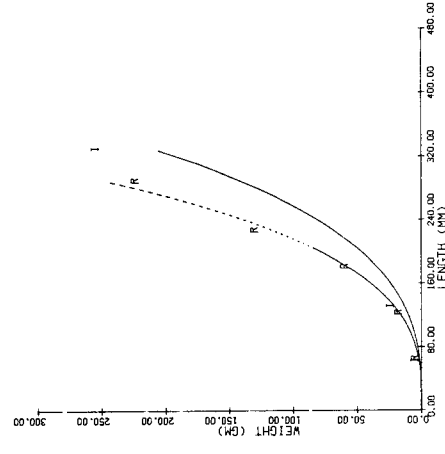
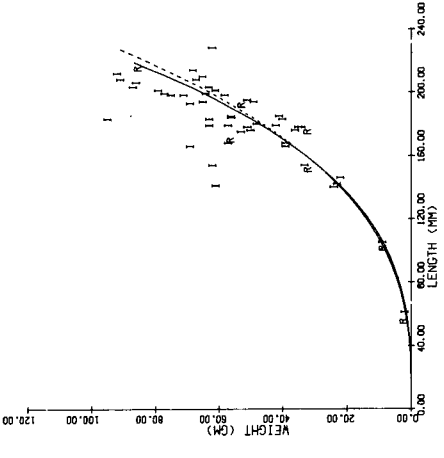
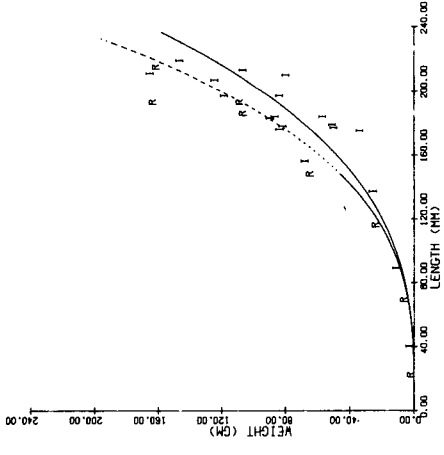

FALL

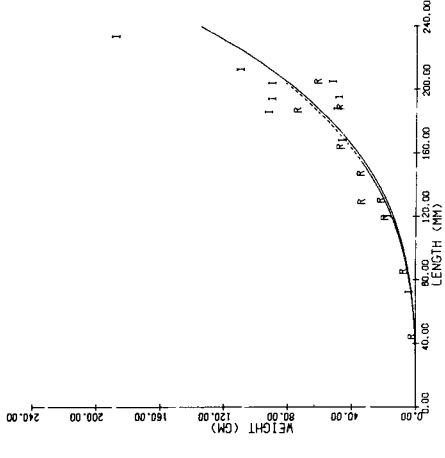
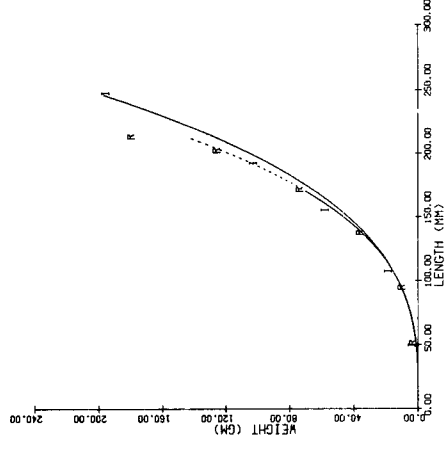

— IMPINGED FISH
- - - RIVER FISH

Figure III-4. Seasonal Plots of Regression Curves for Length/Weight Relationships of Fish Impinged at Unit 2 (I) during 1975 and Fish Collected by Conventional Fishery Gear (R)



SECTION IV

ENVIRONMENTAL VARIABLES INFLUENCING IMPINGEMENT

A. INTRODUCTION

Selected environmental factors were examined to investigate sources of temporal variation in impingement magnitude and species composition. Those selected were conductivity, temperature, and dissolved oxygen inasmuch as results of 1972-1974 studies had indicated that they have the most significant influence on impingement (TI, 1974b, 1975d).

B. METHODS

Temperature ($^{\circ}\text{C}$) and dissolved oxygen (ppm) were measured daily with a YSI Model 54 dissolved oxygen and temperature meter; conductivity ($\mu\text{mho}/\text{cm}$) was measured with a YSI Model 31 SCT meter. Measured conductivity was standardized to 25°C ; dissolved oxygen was standardized and corrected for effects of measured conductivity. Measurements at Unit 1 and Unit 2 intakes were made between 0800 and 1700 at high or low slack tide, with water samples being collected simultaneously from the discharge canal from 2 ft below the surface. Impingement rates were plotted in conjunction with water chemistry data collected during the same period so that short-term variations in impingement which were associated with variations in one or more water-quality variables could be identified.



C. RESULTS

No strong relationship between impingement rates and daily variations of temperature or dissolved oxygen was apparent (Figures IV-1 through IV-4 and Appendix B). White perch impingement displayed an inverse relationship with seasonal temperature trends, reflecting the movement of the species between shoals and the channel, which is keyed to seasonal rise and fall of river temperatures. January and February temperatures tended to increase in association with movement of the salt front past Indian Point; however, this relationship was not consistent or as well-defined as that between salt front movement and impingement in the spring. Minimums in fluctuating oxygen levels during the summer occasionally appeared to coincide with juvenile Atlantic tomcod impingement; the combination of low oxygen levels and high temperatures may stress Atlantic tomcod, which are near the southern limit of their reproductive range.

Only conductivity showed a consistent relationship with peaks in impingement. Figures IV-1 through IV-4 reveal that impingement was not directly related to the level of conductivity but to changes in conductivity related to movement of the salt front through the Indian Point region. Impingement peaks were associated with the beginning and end of conductivity peaks (salt intrusions) throughout 1975. During the summer of previous years, the salt front was generally located north of Indian Point and conductivity at Indian Point relatively stable; impingement collections were low with little variability and had included representatives of several euryhaline marine species (TI, 1974b and 1975d). In July 1975, however, high runoff from local rains caused the



salt front to recede below Indian Point for most of the month. Consequently, the salt front was less stable above Indian Point than during 1972, 1973, and 1974; the location of the salt front near Indian Point fluctuated and impingement rates were more variable.

White perch dominated winter, spring, and late fall impingement collections, and impingement generally peaked before the salt front or after its retreat. Data from fishery collections indicated that white perch were concentrated in the deeper channel water at that time (TI, 1974a). During the summer when the salt front fluctuated near Indian Point, white perch were concentrated in the shore zone beyond the influence of the intakes. Adult Atlantic tomcod impingement peaks generally preceded the incursion of the salt front in winter; juvenile peaks were associated with the leading edge of the salt front during the summer. The relationship between impingement peaks and the salt front was further indicated by increased catch per unit effort for white perch and Atlantic tomcod taken by trawls and epibenthic sleds near the salt front (TI, 1974a, 1975b, 1975c).

In summary, it appears that white perch impingement peaks can be expected as the salt front recedes during fall, winter, and early spring. Atlantic tomcod impingement peaks can be expected when the salt front approaches or remains in the area of Indian Point during early winter and summer. The influence of conductivity on the distribution of fish in the Indian Point region and on impingement may be related to preference for specific salinity ranges or feeding in the vicinity of the salt front. Dissolved oxygen changes observed during 1975 appear to have little effect on impingement. Temperature variation during



winter is associated with movement of the salt front and therefore with impingement variation. Seasonal temperature trends affect fish distribution in the estuary and species collected by impingement but are not directly related to individual impingement peaks outside of winter.

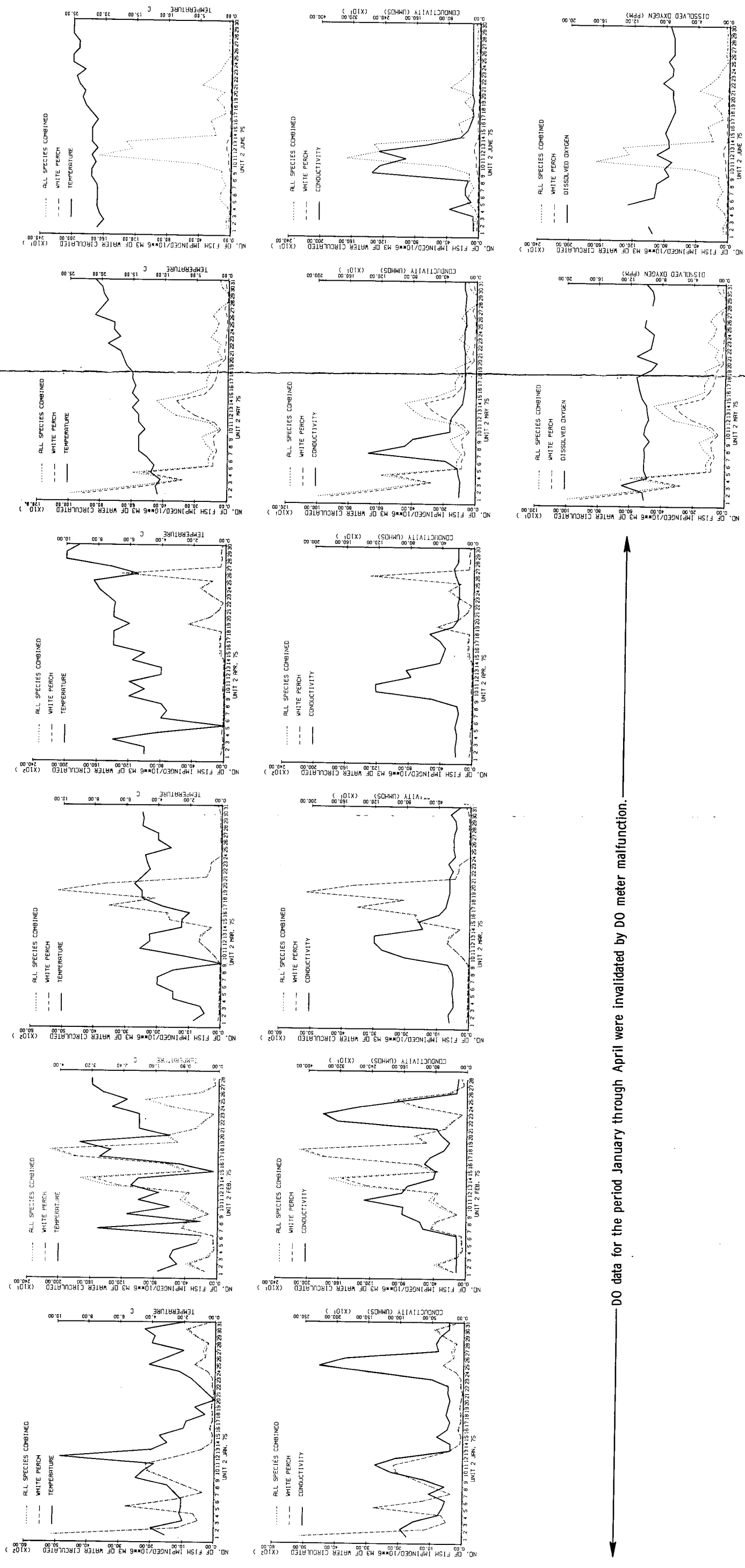

Figure IV-1. Plots of Daily White Perch Impingement Rates with Physicochemical Variables from Unit 2 Intake during 1975 (Page 1 of 2)

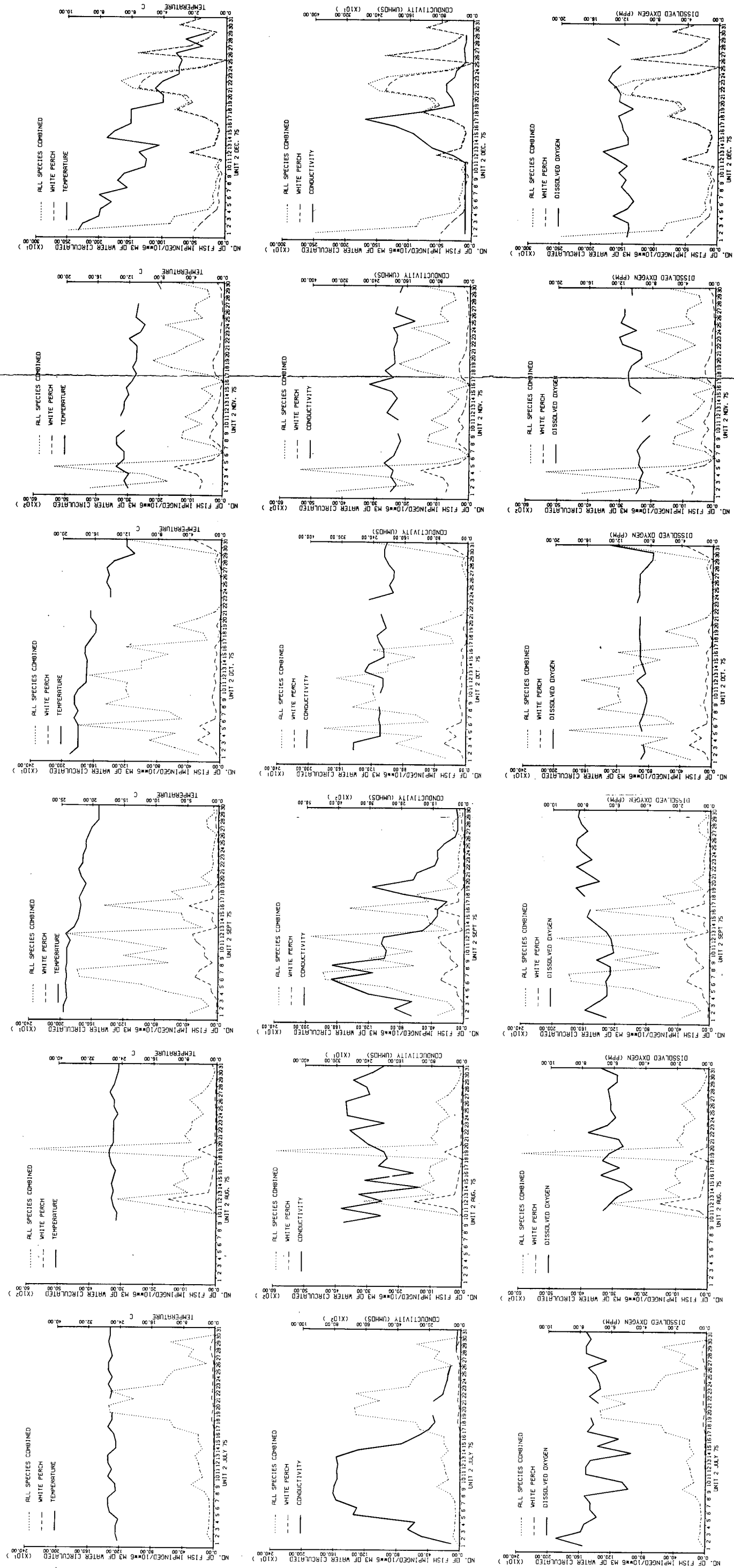

Figure IV-1. (Page 2 of 2)

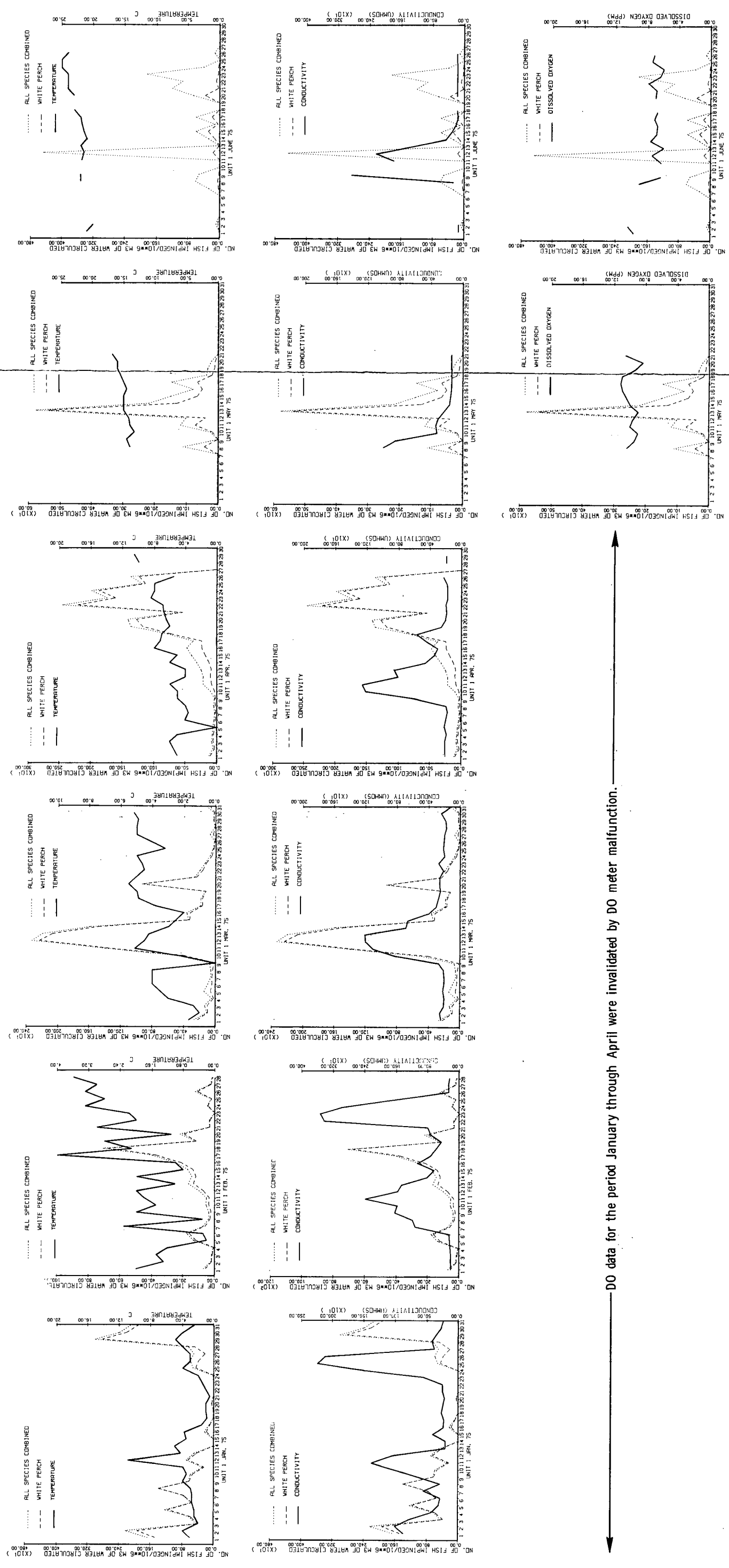
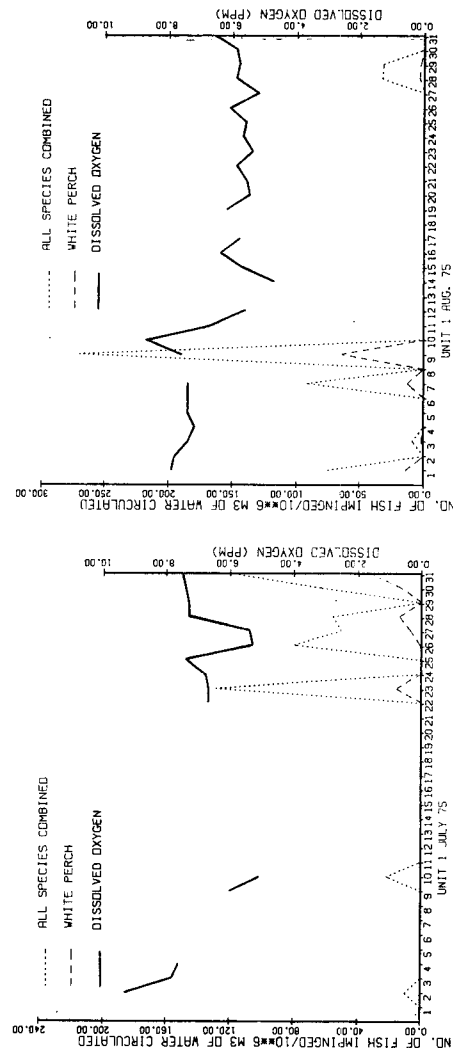
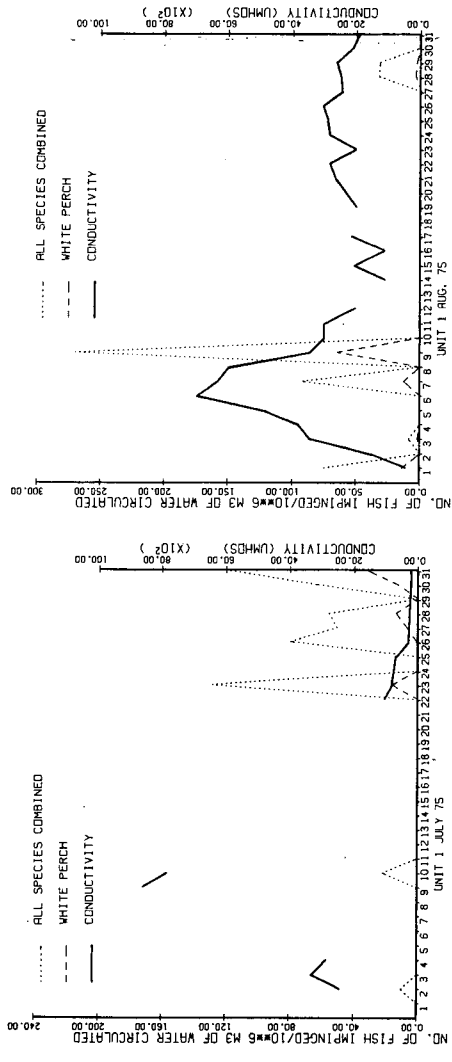
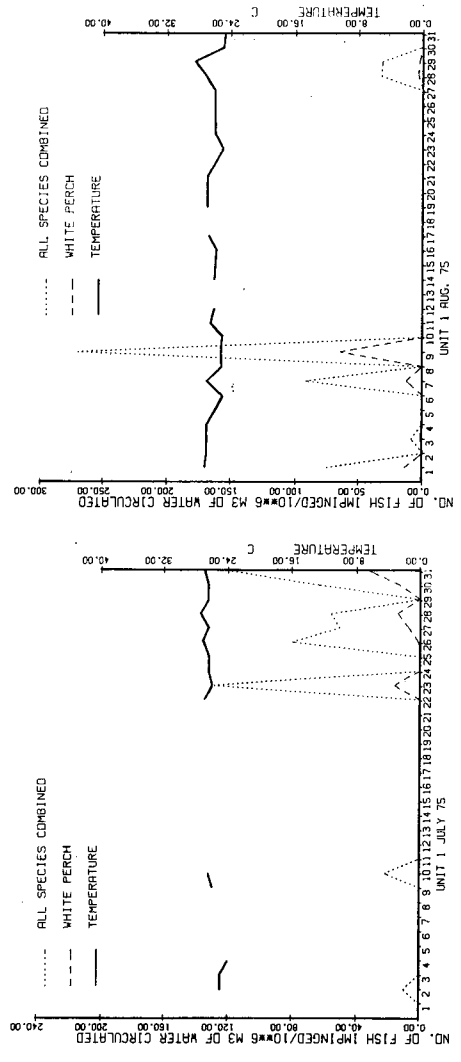
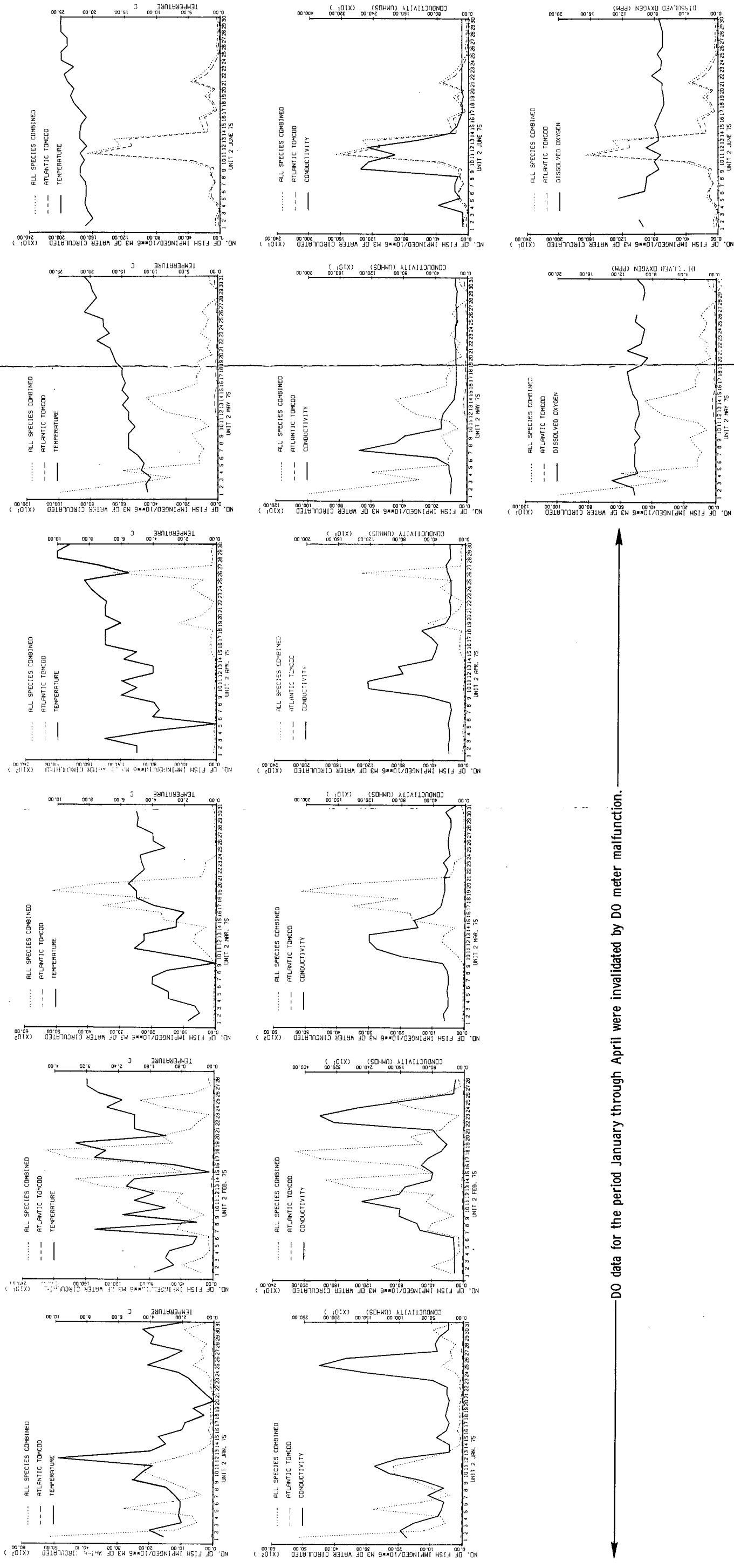

Figure IV-2. Plots of Daily White Perch Impingement Rates with Physicochemical Variables from Unit 1 Intake during 1975 (Page 1 of 2)



Unit 1 was inoperational during September through December 1975.

Figure IV-2. (Page 2 of 2)



DO data for the period January through April were invalidated by DO meter malfunction.

Figure IV-3. Plots of Daily Atlantic Tomcod Impingement Rates with Physico-chemical Variables from Unit 2 Intake during 1975 (Page 1 of 2)

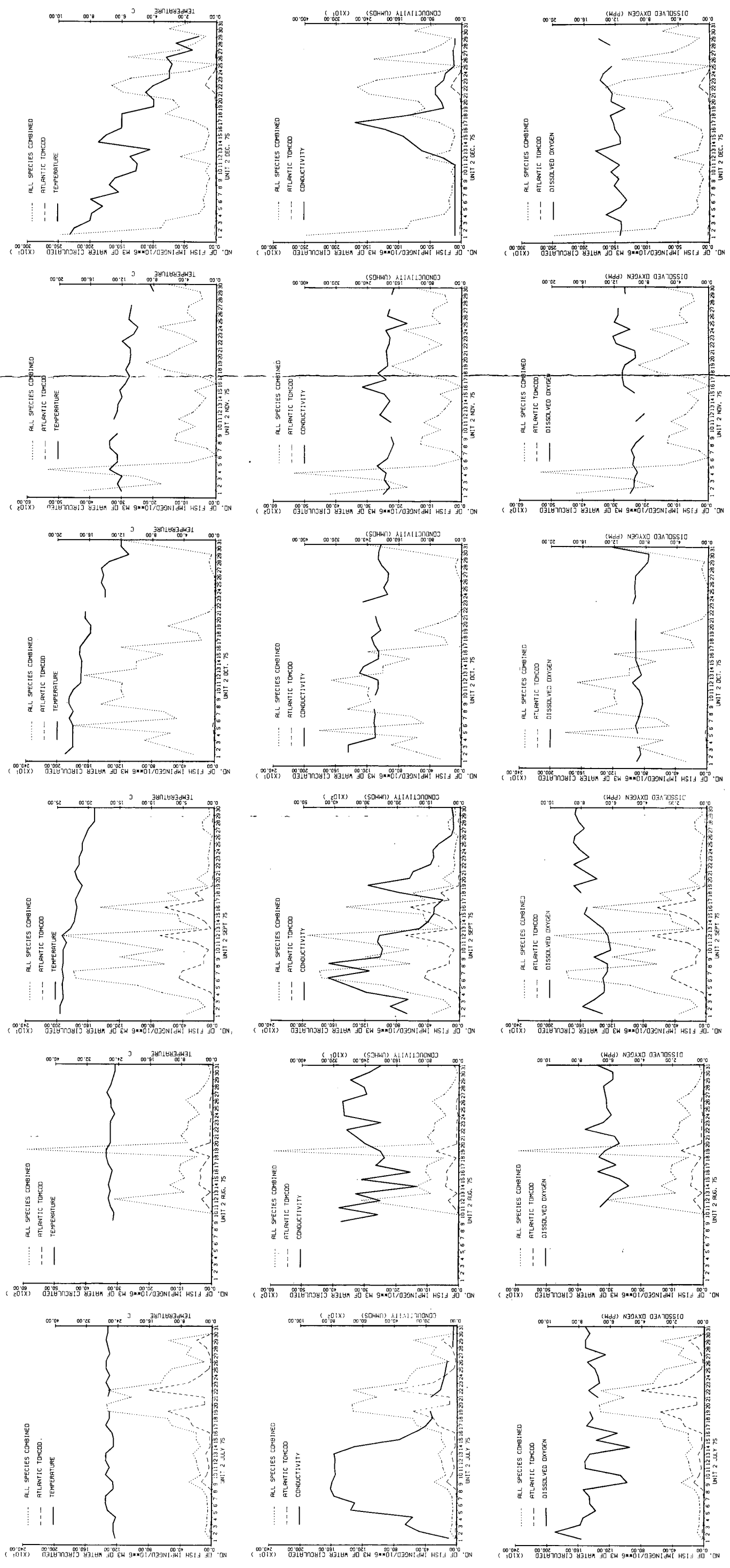

Figure IV-3. (Page 2 of 2)

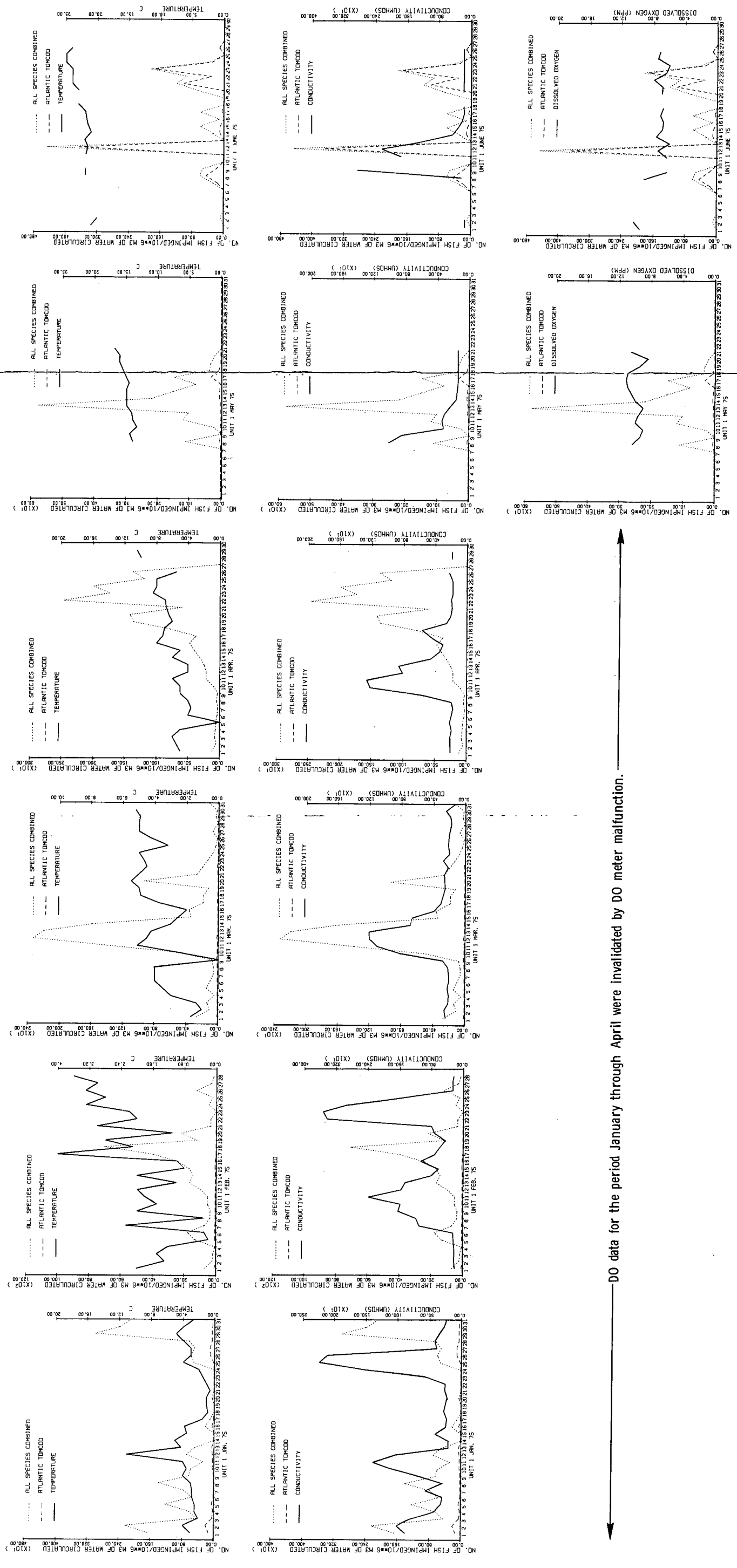
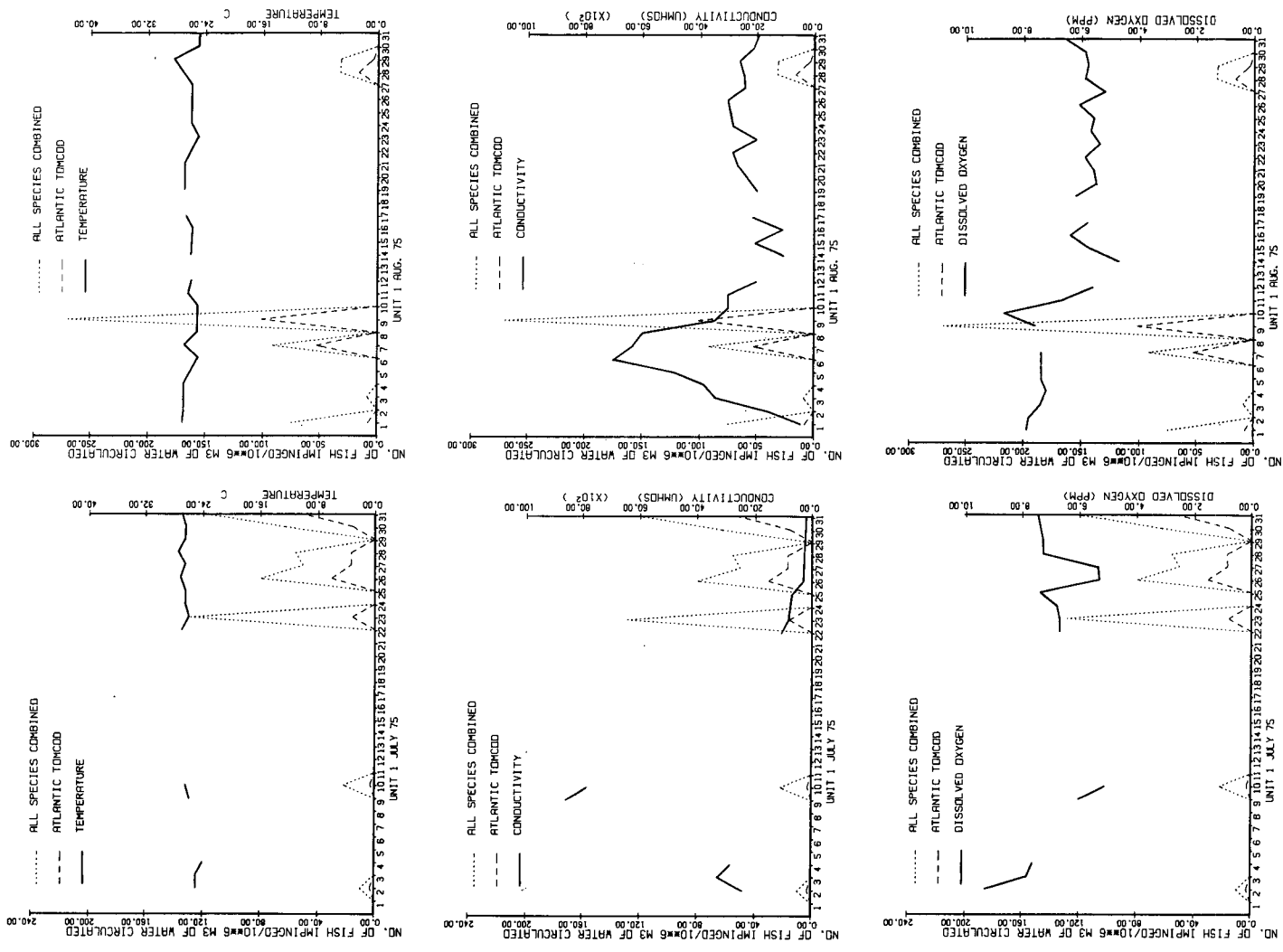

Figure IV-4. Plots of Daily Atlantic Tomcod Impingement Rates with Physicochemical Variables from Unit 1 Intake during 1975 (Page 1 of 2)



Unit 1 was inoperational during September through December 1975.

Figure IV-4. (Page 2 of 2)



SECTION V

LITERATURE CITED

- Brown, M.B. and A.D. Forsythe. 1974. Robust tests for the equality of variances. *Trans. Am. Stat. Assn.* 69: 364-367.
- Brownlee, K.A. 1965. *Statistical theory and methodology.* John Wiley and Sons, New York. p. 376-388.
- Cochran, W.G. 1963. *Sampling techniques.* John Wiley and Sons, New York. 413 p.
- Conover, W.T. 1971. *Practical nonparametric statistics.* John Wiley and Sons, New York. 462 p.
- Draper, N.R. and W.G. Aunter. 1969. Transformations: some examples revisited. *Technometrics* 11:23-40.
- Draper, N.R. and H. Smith. 1966. *Applied regression analysis.* John Wiley and Sons, New York. 407 p.
- Stephens, M.A. 1974. EDF statistics for goodness of fit and some comparisons. *J. Am. Stat. Assn.* 69:730-737.
- Texas Instruments Incorporated. 1974a. Hudson River ecological study in the area of Indian Point. 1973 Annual Rpt. Prepared for Consolidated Edison Company of New York, Inc.
- Texas Instruments Incorporated. 1974b. Indian Point impingement study report for the period 15 June 1972 through 31 December 1973. Prepared for Consolidated Edison Company of New York, Inc.
- Texas Instruments Incorporated. 1975a. Fisheries survey of the Hudson River, March-December 1973, Vol. IV. Draft. Prepared for Consolidated Edison Company of New York, Inc.
- Texas Instruments Incorporated. 1975b. Hudson River ecological study in the area of Indian Point. 1974 Annual Rpt. Prepared for Consolidated Edison Company of New York, Inc.
- Texas Instruments Incorporated. 1975c. Hudson River ecological study in the area of Indian Point. Thermal effects. Draft. Prepared for Consolidated Edison Company of New York, Inc.
- Texas Instruments Incorporated. 1975d. Indian Point impingement study for the period 1 January 1974 to 31 December 1974. Prepared for Consolidated Edison Company of New York, Inc.



Texas Instruments Incorporated. 1975e. 1974 year-class report of the multiplant impact study for the Hudson River estuary, Vol. I and II. Draft. Prepared for Consolidated Edison Company of New York, Inc.

United States Atomic Energy Commission. 1972. Final environmental statement for Indian Point Unit No. 2, September 1972.

Winer, B.J. 1971. Statistical principles in experimental design. McGraw-Hill, New York. 907 p.



APPENDIX A
FISH MONITORING DATA



Table A-1

Dates Used To Delineate Weeks for Impingement Summaries in 1975

Weeks	Dates	Weeks	Dates
1	Jan 1 - Jan 7	27	Jul 2 - Jul 8
2	Jan 8 - Jan 14	28	Jul 9 - Jul 15
3	Jan 15 - Jan 21	29	Jul 16 - Jul 22
4	Jan 22 - Jan 28	30	Jul 23 - Jul 29
5	Jan 29 - Feb 4	31	Jul 30 - Aug 5
6	Feb 5 - Feb 11	32	Aug 6 - Aug 12
7	Feb 12 - Feb 18	33	Aug 13 - Aug 19
8	Feb 19 - Feb 25	34	Aug 20 - Aug 26
9	Feb 26 - Mar 4	35	Aug 27 - Sep 2
10	Mar 5 - Mar 11	36	Sep 3 - Sep 9
11	Mar 12 - Mar 18	37	Sep 10 - Sep 16
12	Mar 19 - Mar 25	38	Sep 17 - Sep 23
13	Mar 26 - Apr 1	39	Sep 24 - Sep 30
14	Apr 2 - Apr 8	40	Oct 1 - Oct 7
15	Apr 9 - Apr 15	41	Oct 8 - Oct 14
16	Apr 16 - Apr 22	42	Oct 15 - Oct 21
17	Apr 23 - Apr 29	43	Oct 22 - Oct 28
18	Apr 30 - May 6	44	Oct 29 - Nov 4
19	May 7 - May 13	45	Nov 5 - Nov 11
20	May 14 - May 20	46	Nov 12 - Nov 18
21	May 21 - May 27	47	Nov 19 - Nov 25
22	May 28 - Jun 3	48	Nov 26 - Dec 2
23	Jun 4 - Jun 10	49	Dec 3 - Dec 9
24	Jun 11 - Jun 17	50	Dec 10 - Dec 16
25	Jun 18 - Jun 24	51	Dec 17 - Dec 23
26	Jun 25 - Jul 1	52	Dec 24 - Dec 30
		53	Dec 31



Table A-2

Daily Impingement Rates for Major Species Impinged
at Unit 1 during 1975

		Number/Million m ³ *						Weight (g/million m ³)*							
		All Species Combined	SB [†]	WP	TC	BH	AL	BA	All Species Combined	SB	WP	TC	BH	AL	BA
Jan	1	1675	28	1489	130	0	4	0	13633	228	9945	2940	0	378	0
	2	2240	37	1943	209	0	0	0	18827	388	12498	5651	0	0	0
	3	442	6	386	36	2	0	0	2895	41	1743	1069	2	0	0
	4	629	2	599	19	0	0	0	2649	13	2001	604	0	0	0
	5	1244	2	1173	53	2	0	0	6440	9	5201	1111	75	0	0
	6	570	2	552	6	0	0	0	2150	348	1542	222	0	0	0
	7	785	2	774	4	0	0	0	2854	126	2575	139	0	0	0
	8	1407	0	1394	11	0	0	0	4926	0	4643	272	0	0	0
	9	637	4	620	6	0	0	0	2320	31	2150	119	0	0	0
	10	584	4	535	38	0	0	0	4074	459	2794	785	0	0	0
	11	277	2	233	30	0	0	0	2406	17	1261	710	0	0	0
	12	702	0	655	41	0	0	0	4025	0	2756	1009	0	0	0
	13	488	2	422	53	2	0	0	4153	23	2841	1242	21	0	0
	14	0	0	0	0	0	0	0	0	0	0	0	0	0	0
	15	0	0	0	0	0	0	0	0	0	0	0	0	0	0
	16	230	2	175	49	0	0	0	4135	23	723	1219	0	0	0
	17	97	0	84	5	0	0	0	522	0	317	154	0	0	0
	18	0	0	0	0	0	0	0	0	0	0	0	0	0	0
	19	0	0	0	0	0	0	0	0	0	0	0	0	0	0
	20	52	0	43	7	0	0	0	581	0	327	137	0	0	0
	21	0	0	0	0	0	0	0	0	0	0	0	0	0	0
	22	0	0	0	0	0	0	0	0	0	0	0	0	0	0
	23	6	0	6	0	0	0	0	34	0	34	0	0	0	0
	24	9	0	2	4	0	0	0	492	0	7	88	0	0	0
	25	526	10	459	20	0	2	0	3936	91	2922	384	0	37	0
	26	601	45	385	107	0	0	0	7103	345	3920	1676	0	0	0
	27	505	24	216	110	2	6	2	8549	231	2191	1703	58	115	2
	28	648	36	491	55	0	2	0	9868	245	7879	914	0	19	0
	29	3018	45	2835	62	0	0	0	32693	796	29459	1082	0	0	0
	30	2382	35	2208	46	6	0	0	28668	388	25704	850	85	0	0
	31	2107	36	1907	48	2	0	0	21286	245	18083	791	17	0	0
Feb	1	696	0	564	85	0	0	0	12701	0	2107	2079	0	0	0
	2	219	4	180	7	0	0	0	1020	35	713	169	0	0	0
	3	173	4	131	18	4	0	0	1492	589	377	427	32	0	0
	4	63	2	38	13	0	0	0	483	23	155	252	0	0	0
	5	1352	10	1194	71	3	0	0	14397	87	10793	1210	23	0	0
	6	1771	19	1625	77	0	0	0	13134	128	11054	1316	0	0	0
	7	697	4	582	57	0	0	0	8252	41	5416	965	0	0	0
	8	372	13	286	38	2	0	0	2645	125	616	702	81	0	0
	9	360	11	226	61	7	0	0	5924	73	3058	1001	601	0	0
	10	551	21	370	60	4	0	0	7028	164	4412	876	90	0	0
	11	513	41	335	50	2	4	0	10624	433	7281	721	61	31	0
	12	988	72	720	61	4	9	0	24432	825	13229	920	81	112	0
	13	1665	157	1341	46	2	11	0	31467	1968	24218	828	14	159	0
	14	1444	97	1183	38	5	5	0	23534	1345	17975	599	38	81	0
	15	1705	113	1379	85	0	7	0	28349	1257	21845	1394	0	58	0
	16	2486	160	2138	50	0	16	0	36691	1879	31214	811	0	165	0
	17	4005	144	3759	14	0	5	0	48800	1324	44239	230	0	47	0
	18	7085	174	6772	22	7	13	0	82369	1689	78027	358	200	95	0
	19	1207	13	1169	5	2	0	0	13842	95	13036	121	16	0	0
	20	2196	72	1946	36	2	9	0	21948	831	17698	612	20	498	0
	21	344	5	315	11	0	0	0	3601	49	3191	209	0	0	0
	22	349	7	293	13	2	0	0	3633	41	2656	282	14	0	0
	23	0	0	0	0	0	0	0	0	0	0	0	0	0	0
	24	487	18	445	1	0	2	0	5270	123	4835	20	0	12	0
	25	225	4	209	2	0	2	0	2680	49	2245	32	0	9	0
	26	1255	41	1108	9	5	5	0	21320	588	11703	185	38	129	0
	27	304	20	234	5	2	2	0	2849	162	1869	90	11	13	0
	28	171	13	124	0	5	0	0	1471	110	1081	0	36	0	0

*Recorded to the nearest whole number.

[†]SB = striped bass; WP = white perch; TC = Atlantic tomcod; BH = blueback herring; AL = alewife; BA = bay anchovy.



Table A-2 (Contd)

	Number/Million m ³ *							Weight (g/million m ³)*						
	All Species Combined	SB [†]	WP	TC	BH	AL	BA	All Species Combined	SB	WP	TC	BH	AL	BA
Mar 1	270	9	223	4	2	0	0	2345	68	1588	68	14	0	0
2	103	2	94	0	0	0	0	586	9	520	0	0	0	0
3	135	4	99	2	2	0	0	1969	14	1468	36	13	0	0
4	41	2	19	4	0	0	0	266	18	123	37	0	0	0
5	142	11	58	0	0	0	0	3156	183	674	0	0	0	0
6	94	5	38	5	0	0	0	1387	92	543	76	0	0	0
7	52	2	38	0	0	0	0	1414	22	462	0	0	0	0
8	56	5	30	7	0	0	0	1035	81	485	111	0	0	0
9	74	0	13	13	0	0	0	2284	0	626	216	0	0	0
10	489	11	412	5	0	2	0	4656	81	3374	122	0	20	0
11	1403	11	1351	4	0	0	0	9719	81	8709	74	0	0	0
12	2333	18	2241	13	7	0	0	15335	155	14272	180	128	0	0
13	2198	40	2072	0	0	4	0	18178	311	16381	0	0	34	0
14	1576	23	1477	2	2	4	0	13385	194	12309	32	13	25	0
15	344	2	329	0	0	4	0	6871	18	4914	0	0	640	0
16	369	7	320	2	0	0	0	9633	487	7121	43	0	0	0
17	185	2	166	9	0	0	0	2207	7	804	218	0	0	0
18	186	0	166	4	0	0	0	840	0	700	70	0	0	0
19	122	0	122	0	0	0	0	734	0	734	0	0	0	0
20	934	6	919	0	0	0	0	3200	43	3112	0	0	0	0
21	265	4	241	6	0	0	0	1666	34	1109	122	0	0	0
22	196	0	160	13	0	0	0	2338	0	1792	213	0	0	0
23	130	2	115	0	0	0	0	1485	6	1429	0	0	0	0
24	68	2	45	2	0	2	0	1837	6	454	45	0	922	0
25	30	0	21	2	0	0	0	651	0	540	83	0	0	0
26	13	2	2	2	0	0	0	316	245	6	41	0	0	0
27	72	0	30	0	0	0	0	488	0	272	0	0	0	0
28	10	0	2	0	0	0	0	334	0	38	0	0	0	0
29	27	0	22	0	0	0	0	254	0	223	0	0	0	0
30	17	0	13	0	0	0	0	72	0	54	0	0	0	0
31	120	0	70	2	0	0	0	1656	0	1078	22	0	0	0
Apr 1	118	2	100	0	0	0	0	1277	7	1179	0	0	0	0
2	58	0	32	0	0	0	0	849	0	495	0	0	0	0
3	81	0	59	0	0	0	0	683	0	596	0	0	0	0
4	66	0	47	4	0	0	0	932	0	781	96	0	0	0
5	60	0	38	0	0	0	0	407	0	316	0	0	0	0
6	39	0	17	0	0	0	0	259	0	179	0	0	0	0
7	31	0	19	2	0	0	0	428	0	148	23	0	0	0
8	51	0	28	2	0	0	0	535	0	260	36	0	0	0
9	34	0	26	0	0	0	0	177	0	149	0	0	0	0
10	102	0	37	2	0	0	0	518	0	298	47	0	0	0
11	220	2	87	2	0	0	0	1361	12	874	45	0	0	0
12	218	0	105	0	0	0	0	1797	0	1250	0	0	0	0
13	254	2	90	0	0	0	0	1945	11	1250	0	0	0	0
14	322	2	127	4	2	0	0	2081	8	1431	50	6	0	0
15	407	6	188	2	6	4	0	3437	47	2562	28	23	32	0
16	477	4	244	4	17	0	0	3807	17	2971	71	63	0	0
17	375	10	248	0	2	0	0	3748	81	3200	0	6	0	0
18	798	6	746	0	8	0	0	9198	52	8237	0	23	0	0
19	1372	8	1188	2	25	0	0	12114	48	11345	44	79	0	0
20	1418	10	1288	2	4	2	0	13945	138	12925	42	75	348	0
21	598	3	541	1	2	0	0	7440	31	7040	13	6	0	0
22	2458	21	2215	7	13	1	0	28323	193	25389	197	257	334	0
23	1742	20	1609	0	11	0	0	21960	203	20055	0	39	0	0
24	1994	19	1875	1	9	4	0	26336	157	23778	31	41	1005	0
25	1195	6	1147	1	3	0	0	17813	78	17231	45	213	0	0
26	1376	4	1246	5	4	4	0	21918	60	19442	111	254	620	0
27	0	0	0	0	0	0	0	0	0	0	0	0	0	0
28	0	0	0	0	0	0	0	0	0	0	0	0	0	0
29	0	0	0	0	0	0	0	0	0	0	0	0	0	0
30	0	0	0	0	0	0	0	0	0	0	0	0	0	0

*Recorded to the nearest whole number.

†SB = striped bass; WP = white perch; TC = Atlantic tomcod; BH = blueback herring; AL = alewife; BA = bay anchovy.



Table A-2 (Contd)

	Number/Million m ³ *							Weight (g/million m ³)*						
	All Species Combined	SB†	WP	TC	BH	AL	BA	All Species Combined	SB	WP	TC	BH	AL	BA
May 1	0	0	0	0	0	0	0	0	0	0	0	0	0	0
2	0	0	0	0	0	0	0	0	0	0	0	0	0	0
3	0	0	0	0	0	0	0	0	0	0	0	0	0	0
4	0	0	0	0	0	0	0	0	0	0	0	0	0	0
5	0	0	0	0	0	0	0	0	0	0	0	0	0	0
6	0	0	0	0	0	0	0	0	0	0	0	0	0	0
7	0	0	0	0	0	0	0	0	0	0	0	0	0	0
8	112	0	44	5	1	2	0	897	0	250	5	6	241	0
9	0	0	0	0	0	0	0	0	0	0	0	0	0	0
10	23	0	17	0	0	0	0	260	0	228	0	0	0	0
11	120	3	73	0	1	0	0	1325	9	808	0	3	0	0
12	102	0	39	4	1	2	0	813	0	225	4	5	216	0
13	579	0	541	2	3	2	0	1072	0	541	2	16	303	0
14	218	1	131	6	19	3	0	1632	8	585	6	110	549	0
15	149	1	66	4	9	1	0	1517	5	504	4	50	317	0
16	79	0	50	1	0	3	0	1029	0	187	1	0	529	0
17	148	1	66	32	6	1	0	2935	6	422	32	27	268	0
18	36	0	18	6	3	0	0	405	0	169	6	13	0	0
19	32	0	10	0	1	1	0	317	0	71	0	4	46	0
20	20	0	8	1	0	0	0	259	0	56	1	0	0	0
21	0	0	0	0	0	0	0	0	0	0	0	0	0	0
22	0	0	0	0	0	0	0	0	0	0	0	0	0	0
23	0	0	0	0	0	0	0	0	0	0	0	0	0	0
24	0	0	0	0	0	0	0	0	0	0	0	0	0	0
25	0	0	0	0	0	0	0	0	0	0	0	0	0	0
26	0	0	0	0	0	0	0	0	0	0	0	0	0	0
27	0	0	0	0	0	0	0	0	0	0	0	0	0	0
28	0	0	0	0	0	0	0	0	0	0	0	0	0	0
29	0	0	0	0	0	0	0	0	0	0	0	0	0	0
30	0	0	0	0	0	0	0	0	0	0	0	0	0	0
31	0	0	0	0	0	0	0	0	0	0	0	0	0	0
Jun 1	0	0	0	0	0	0	0	0	0	0	0	0	0	0
2	9	0	4	1	0	2	0	633	0	137	1	0	304	0
3	0	0	0	0	0	0	0	0	0	0	0	0	0	0
4	0	0	0	0	0	0	0	0	0	0	0	0	0	0
5	0	0	0	0	0	0	0	0	0	0	0	0	0	0
6	0	0	0	0	0	0	0	0	0	0	0	0	0	0
7	28	0	3	17	3	0	0	102	0	23	26	15	0	0
8	61	0	5	45	3	0	0	422	0	36	102	130	0	0
9	52	0	1	19	0	1	16	606	0	71	32	0	235	58
10	0	0	0	0	0	0	0	0	0	0	0	0	0	0
11	0	0	0	0	0	0	0	0	0	0	0	0	0	0
12	448	0	17	368	7	0	2	1553	0	96	829	71	0	7
13	0	0	0	0	0	0	0	0	0	0	0	0	0	0
14	29	0	13	11	3	1	0	708	0	262	52	148	122	0
15	60	0	29	9	1	1	3	1663	0	678	64	47	152	9
16	11	0	4	0	1	0	0	1773	0	111	0	147	0	0
17	60	0	19	6	6	3	0	1553	0	755	18	391	129	0
18	0	0	0	0	0	0	0	0	0	0	0	0	0	0
19	0	0	0	0	0	0	0	0	0	0	0	0	0	0
20	67	0	37	0	0	0	11	923	0	673	0	0	0	27
21	120	0	3	102	1	8	0	557	0	187	240	6	19	0
22	93	0	9	31	0	0	30	664	0	190	222	0	0	74
23	185	0	3	174	0	4	3	1125	0	186	486	0	444	6
24	40	0	3	30	0	0	5	305	0	57	81	0	0	14
25	0	0	0	0	0	0	0	0	0	0	0	0	0	0
26	13	0	0	12	0	1	1	118	0	0	25	0	91	2
27	0	0	0	0	0	0	0	0	0	0	0	0	0	0
28	0	0	0	0	0	0	0	0	0	0	0	0	0	0
29	0	0	0	0	0	0	0	0	0	0	0	0	0	0
30	0	0	0	0	0	0	0	0	0	0	0	0	0	0

*Recorded to the nearest whole number.

†SB = striped bass; WP = white perch; TC = Atlantic tomcod; BH = blueback herring; AL = alewife; BA = bay anchovy.



Table A-2 (Contd)

		Number/Million m ³ *						Weight (g/million m ³)*							
		All Species Combined	SB [†]	WP	TC	BH	AL	BA	All Species Combined	SB	WP	TC	BH	AL	BA
Jul	1	0	0	0	0	0	0	0	0	0	0	0	0	0	0
	2	10	0	0	3	0	3	3	313	0	0	307	0	3	3
	3	0	0	0	0	0	0	0	0	0	0	0	0	0	0
	4	0	0	0	0	0	0	0	0	0	0	0	0	0	0
	5	0	0	0	0	0	0	0	0	0	0	0	0	0	0
	6	0	0	0	0	0	0	0	0	0	0	0	0	0	0
	7	0	0	0	0	0	0	0	0	0	0	0	0	0	0
	8	0	0	0	0	0	0	0	0	0	0	0	0	0	0
	9	0	0	0	0	0	0	0	0	0	0	0	0	0	0
	10	22	0	0	0	0	0	17	82	0	0	0	0	0	63
	11	0	0	0	0	0	0	0	0	0	0	0	0	0	0
	12	0	0	0	0	0	0	0	0	0	0	0	0	0	0
	13	0	0	0	0	0	0	0	0	0	0	0	0	0	0
	14	0	0	0	0	0	0	0	0	0	0	0	0	0	0
	15	0	0	0	0	0	0	0	0	0	0	0	0	0	0
	16	0	0	0	0	0	0	0	0	0	0	0	0	0	0
	17	0	0	0	0	0	0	0	0	0	0	0	0	0	0
	18	0	0	0	0	0	0	0	0	0	0	0	0	0	0
	19	0	0	0	0	0	0	0	0	0	0	0	0	0	0
	20	0	0	0	0	0	0	0	0	0	0	0	0	0	0
	21	0	0	0	0	0	0	0	0	0	0	0	0	0	0
	22	0	0	0	0	0	0	0	0	0	0	0	0	0	0
	23	129	0	16	16	10	8	55	621	0	166	57	16	65	112
	24	0	0	0	0	0	0	0	0	0	0	0	0	0	0
	25	0	0	0	0	0	0	0	0	0	0	0	0	0	0
	26	80	1	1	31	7	3	30	343	1	79	122	10	26	84
	27	51	0	7	17	1	0	20	201	0	10	53	2	0	57
	28	56	0	14	17	2	1	14	533	0	202	50	21	26	37
	29	0	0	0	0	0	0	0	0	0	0	0	0	0	0
	30	64	5	13	16	2	0	13	380	5	166	76	4	0	26
	31	120	7	33	52	2	2	13	938	8	348	243	7	5	39
Aug	1	75	7	14	8	1	2	36	419	11	169	80	1	39	74
	2	0	0	0	0	0	0	0	0	0	0	0	0	0	0
	3	9	0	2	1	0	1	4	326	0	14	2	0	2	4
	4	0	0	0	0	0	0	0	0	0	0	0	0	0	0
	5	0	0	0	0	0	0	0	0	0	0	0	0	0	0
	6	0	0	0	0	0	0	0	0	0	0	0	0	0	0
	7	92	1	13	53	0	1	13	631	5	19	268	0	2	25
	8	0	0	0	0	0	0	0	0	0	0	0	0	0	0
	9	270	0	65	102	0	0	56	2017	0	367	599	0	0	177
	10	0	0	0	0	0	0	0	0	0	0	0	0	0	0
	11	0	0	0	0	0	0	0	0	0	0	0	0	0	0
	12	0	0	0	0	0	0	0	0	0	0	0	0	0	0
	13	0	0	0	0	0	0	0	0	0	0	0	0	0	0
	14	0	0	0	0	0	0	0	0	0	0	0	0	0	0
	15	0	0	0	0	0	0	0	0	0	0	0	0	0	0
	16	0	0	0	0	0	0	0	0	0	0	0	0	0	0
	17	0	0	0	0	0	0	0	0	0	0	0	0	0	0
	18	0	0	0	0	0	0	0	0	0	0	0	0	0	0
	19	0	0	0	0	0	0	0	0	0	0	0	0	0	0
	20	0	0	0	0	0	0	0	0	0	0	0	0	0	0
	21	0	0	0	0	0	0	0	0	0	0	0	0	0	0
	22	0	0	0	0	0	0	0	0	0	0	0	0	0	0
	23	0	0	0	0	0	0	0	0	0	0	0	0	0	0
	24	0	0	0	0	0	0	0	0	0	0	0	0	0	0
	25	0	0	0	0	0	0	0	0	0	0	0	0	0	0
	26	0	0	0	0	0	0	0	0	0	0	0	0	0	0
	27	0	0	0	0	0	0	0	0	0	0	0	0	0	0
	28	33	0	4	17	0	0	8	95	0	8	54	0	0	17
	29	32	0	3	4	1	0	17	141	0	48	14	3	0	45
	30	0	0	0	0	0	0	0	0	0	0	0	0	0	0
	31	0	0	0	0	0	0	0	0	0	0	0	0	0	0

Sep-Dec^{††}

*Recorded to the nearest whole number.

[†]SB = striped bass; WP = white perch; TC = Atlantic tomcod; BH = blueback herring; AL = alewife; BA = bay anchovy.

^{††}During these months, Unit 1 did not operate.



Table A-3

Daily Impingement Rates for Major Species Impinged
at Unit 2 during 1975

		Number/Million m ³ *						Weight (g/million m ³)*							
		All Species Combined	SB [†]	WP	TC	BH	AL	BA	All Species Combined	SB	WP	TC	BH	AL	BA
Jan	1	5127	27	5017	24	0	0	0	27097	242	25681	520	0	0	0
	2	1171	2	1167	2	0	0	0	4064	20	4006	38	0	0	0
	3	513	0	509	0	0	0	0	1723	0	1599	0	0	0	0
	4	662	0	657	0	0	0	0	1872	0	1859	0	0	0	0
	5	2806	7	2765	11	2	0	0	12650	35	12283	234	15	0	0
	6	1254	3	1241	4	0	0	0	4870	22	4760	63	0	0	0
	7	368	1	366	0	0	0	0	1458	4	1450	0	0	0	0
	8	974	1	966	2	0	0	0	4131	1	4031	83	0	0	0
	9	1544	3	1518	12	0	0	0	8394	17	7593	296	0	0	0
	10	2133	6	2098	19	0	0	0	10854	52	9893	364	0	0	0
	11	2177	5	2143	20	0	0	0	11236	40	10209	399	0	0	0
	12	1237	2	1225	5	0	0	0	6527	33	6301	130	0	0	0
	13	429	0	406	14	1	0	0	3699	0	2992	283	60	0	0
	14	92	1	82	7	0	0	0	601	1	456	132	0	0	0
	15	61	1	52	6	0	0	0	433	34	262	98	0	0	0
	16	162	1	138	14	0	0	0	1155	5	665	295	0	0	0
	17	75	1	60	7	0	0	0	667	3	303	122	0	0	0
	18	80	1	58	7	0	0	0	494	4	276	102	0	0	0
	19	109	1	97	6	0	0	0	536	4	386	93	0	0	0
	20	72	1	60	6	0	0	0	415	10	205	115	0	0	0
	21	28	1	22	2	0	0	0	209	15	146	32	0	0	0
	22	95	0	79	11	0	0	0	574	0	319	197	0	0	0
	23	77	0	70	4	0	0	0	622	0	450	64	0	0	0
	24	236	1	230	2	0	0	0	908	5	817	68	0	0	0
	25	658	5	648	0	0	1	0	2214	24	2170	0	0	3	0
	26	329	7	307	6	0	0	0	2461	58	2186	107	0	0	0
	27	389	7	299	55	0	0	0	3953	232	2268	1036	0	0	0
	28	229	3	210	9	0	0	0	1461	17	1206	168	0	0	0
	29	642	8	616	6	0	0	0	4083	57	3778	111	0	3	0
	30	945	11	883	18	0	0	0	6262	77	5032	325	0	0	0
	31	158	1	135	9	0	0	0	982	4	790	143	0	0	0
Feb	1	161	0	153	8	0	0	0	1230	0	1121	109	0	0	0
	2	395	6	349	9	0	0	0	1659	30	1410	112	0	0	0
	3	135	5	107	7	0	0	0	752	35	446	178	0	0	0
	4	44	2	36	3	0	0	0	334	13	236	46	0	0	0
	5	58	1	50	3	0	0	0	288	3	203	37	0	0	0
	6	59	1	54	2	1	0	0	478	4	421	41	5	0	0
	7	451	2	438	4	0	0	0	3388	12	3034	68	0	0	0
	8	391	7	370	2	0	1	2	3126	78	2925	32	0	5	3
	9	121	3	112	2	0	0	0	1430	37	1308	28	0	0	0
	10	330	8	283	13	0	1	0	4049	75	3504	182	0	3	0
	11	470	16	414	14	1	0	0	7237	129	6296	203	3	0	0
	12	382	8	355	5	0	0	0	3866	51	3586	73	0	0	0
	13	1401	60	1266	25	1	2	0	19498	554	17421	444	12	17	0
	14	1734	47	1577	19	1	2	0	17571	553	14708	319	6	47	0
	15	401	21	356	9	0	2	0	3473	182	2930	132	0	39	0
	16	661	15	624	8	1	2	0	5861	124	5516	118	1	30	0
	17	1821	13	1785	7	0	1	0	11673	139	11150	129	0	19	0
	18	2117	26	2074	3	0	2	0	11865	319	11347	43	0	13	0
	19	520	6	507	3	1	1	0	3396	56	3262	54	3	4	0
	20	667	9	646	1	0	1	0	3851	70	3622	18	0	4	0
	21	290	5	272	1	1	0	0	1381	48	1266	21	5	0	0
	22	195	4	179	1	0	0	0	1296	49	1190	14	0	0	0
	23	66	1	60	0	0	1	0	527	8	474	0	0	4	0
	24	622	5	589	2	1	2	0	3566	32	3353	26	3	34	0
	25	932	17	890	1	0	2	0	6334	133	5733	13	0	10	0
	26	245	10	208	9	1	0	0	2585	62	1715	139	4	0	0
	27	46	1	43	0	0	0	0	353	10	341	0	0	0	0
	28	73	3	54	2	0	1	0	535	23	393	29	0	14	0

*Recorded to the nearest whole number.

[†]SB = striped bass; WP = white perch; TC = Atlantic tomcod; BH = blueback herring; AL = alewife; BA = bay anchovy.



Table A-3 (Contd)

		Number/Million m ³ *						Weight (g/million m ³)*							
		All Species Combined	SB†	WP	TC	BH	AL	BA	All Species Combined	SB	WP	TC	BH	AL	BA
Mar	1	60	1	54	1	1	0	0	431	6	266	10	4	0	0
	2	26	2	21	2	0	0	0	245	9	182	30	0	0	0
	3	42	1	28	2	1	0	0	591	6	337	42	9	0	0
	4	31	2	15	2	1	0	0	489	14	201	50	3	0	0
	5	43	2	25	3	0	0	0	247	12	132	61	0	0	0
	6	22	0	19	2	0	0	0	138	0	93	43	0	0	0
	7	25	2	20	0	0	0	0	464	19	385	0	0	0	0
	8	14	0	13	0	0	0	0	296	0	209	0	0	0	0
	9	38	1	24	0	0	0	0	385	5	284	0	0	0	0
	10	205	0	190	0	1	0	0	1262	0	1094	0	11	0	0
	11	446	1	436	0	0	0	0	2111	11	2027	0	0	0	0
	12	703	4	697	0	0	0	0	4693	869	3700	0	0	0	0
	13	638	4	571	0	0	0	0	3563	18	3078	0	0	0	0
	14	297	0	297	0	0	0	0	1538	0	1531	0	0	0	0
	15	1636	7	1621	0	0	0	0	11791	46	11630	0	0	0	0
	16	1738	37	1688	2	0	0	0	11767	227	11125	33	0	0	0
	17	3542	11	3514	2	0	0	2	15600	57	15430	41	0	0	0
	18	2101	13	2075	2	0	0	0	10345	70	10219	33	0	0	0
	19	5166	6	5153	0	0	0	0	22484	25	22016	0	0	0	0
	20	3668	4	3660	0	0	0	0	14341	29	14304	0	0	0	0
	21	472	3	464	2	0	1	0	3806	20	3718	51	0	10	0
	22	363	0	352	0	0	0	0	2636	0	2506	0	0	0	0
	23	327	0	319	0	0	0	0	2381	0	2325	0	0	0	0
	24	0	0	0	0	0	0	0	0	0	0	0	0	0	0
	25	0	0	0	0	0	0	0	0	0	0	0	0	0	0
	26	35	0	32	0	0	0	0	462	0	447	0	0	0	0
	27	12	0	8	1	0	0	0	62	0	27	11	0	0	0
	28	50	0	42	0	0	0	0	1116	0	736	0	0	0	0
	29	36	0	34	0	0	0	0	448	0	351	0	0	0	0
	30	62	0	57	0	0	0	0	608	0	535	0	0	0	0
	31	135	0	129	0	0	0	0	1060	0	1043	0	0	0	0
Apr	1	356	1	346	0	0	0	0	4017	10	3942	0	0	0	0
	2	144	1	134	0	0	0	0	1240	7	1114	0	0	0	0
	3	116	0	115	0	0	0	0	710	0	699	0	0	0	0
	4	298	1	276	0	0	0	0	2204	7	1897	0	0	0	0
	5	147	0	78	0	0	0	0	2113	0	1643	8	0	0	0
	6	75	0	41	0	1	0	0	849	0	614	6	3	0	0
	7	78	0	45	0	1	0	0	1139	0	646	6	4	0	0
	8	58	0	48	0	0	0	0	850	0	600	0	0	156	0
	9	108	1	92	0	0	0	0	976	10	910	0	0	0	0
	10	225	4	195	0	1	0	0	2003	36	1785	1	3	0	0
	11	98	2	76	0	0	0	0	1251	15	1164	0	0	0	0
	12	136	5	92	0	0	0	0	1956	46	1647	0	0	0	0
	13	152	3	108	0	0	0	0	1863	21	1674	0	0	0	0
	14	141	4	86	0	1	0	0	1183	33	867	13	3	0	0
	15	691	7	490	0	2	0	0	5465	50	4701	0	7	4	0
	16	694	8	556	1	5	0	0	8847	69	8218	52	15	0	0
	17	693	5	590	0	3	0	0	7468	28	7016	5	11	0	0
	18	478	2	431	1	1	0	0	4623	14	4423	19	3	1	0
	19	4675	27	4507	1	6	0	0	49848	189	48409	30	33	61	0
	20	1958	9	1861	1	4	0	0	14108	80	13707	38	12	0	0
	21	811	6	732	0	2	0	0	9616	48	9131	9	5	57	0
	22	311	1	284	0	1	0	0	2861	3	2766	0	3	0	0
	23	1896	8	1811	4	2	0	0	28423	86	27220	118	35	0	0
	24	3183	22	3049	6	6	0	0	40476	282	38867	183	20	0	0
	25	1705	9	1591	4	8	0	0	24778	56	23641	129	114	0	0
	26	13058	57	12476	16	19	0	0	144638	456	135612	582	214	0	0
	27	633	1	606	0	2	0	0	11136	5	10487	0	58	0	0
	28	500	2	455	1	2	0	0	8348	26	7814	32	6	0	0
	29	643	2	589	0	4	0	0	10963	22	9877	0	15	0	0
	30	400	2	361	0	6	0	0	5442	13	4896	9	19	51	0

*Recorded to the nearest whole number.

†SB = striped bass; WP = white perch; TC = Atlantic tomcod; BH = blueback herring; AL = alewife; BA = bay anchovy.



Table A-3 (Contd)

		Number/Million m ³ *							Weight (g/million m ³)*						
		All Species Combined	SB†	WP	TC	BH	AL	BA	All Species Combined	SB	WP	TC	BH	AL	BA
May	1	991	2	912	0	21	0	0	7112	55	6342	5	66	0	0
	2	619	2	544	0	10	0	0	7901	21	6761	0	40	87	0
	3	300	1	278	0	3	0	0	3157	9	2720	0	13	0	0
	4	595	1	530	0	6	1	0	3931	2	3448	0	19	7	0
	5	115	0	85	0	0	0	0	1437	2	1046	0	0	84	0
	6	119	0	88	0	0	0	0	1181	0	826	0	1	0	0
	7	87	1	64	0	0	0	0	1246	5	943	5	1	0	0
	8	135	1	83	1	1	1	0	2061	8	1274	10	4	148	0
	9	160	1	87	1	2	0	1	1938	10	1107	6	147	0	4
	10	56	0	40	0	0	1	0	1110	0	810	14	0	137	0
	11	111	1	81	0	1	0	0	1073	4	713	10	68	0	1
	12	327	2	206	14	2	2	0	3237	16	1820	28	36	401	0
	13	397	1	279	19	5	0	0	3185	6	1997	26	23	119	1
	14	446	3	322	22	6	2	0	3287	19	1942	44	34	205	0
	15	245	1	143	11	6	2	0	2298	6	884	33	34	404	0
	16	130	0	97	2	1	0	1	937	0	599	2	12	56	3
	17	133	1	74	12	2	1	0	1327	2	540	12	12	191	0
	18	105	0	63	7	1	1	0	990	0	322	7	6	115	0
	19	131	0	56	12	1	1	0	1961	0	410	12	3	283	0
	20	34	0	14	1	1	1	0	716	0	232	1	4	124	0
	21	66	0	23	5	1	1	0	1174	0	331	5	3	110	0
	22	44	0	12	1	1	1	0	895	0	212	1	5	99	0
	23	109	1	11	3	1	0	0	1644	8	265	3	18	0	0
	24	72	0	5	1	1	1	0	1683	0	114	1	10	141	1
	25	58	0	4	2	1	1	0	933	0	120	11	8	90	0
	26	96	0	11	7	1	1	0	1783	7	303	7	75	149	0
	27	56	0	26	12	0	1	0	782	0	427	15	2	29	1
	28	0	0	0	0	0	0	0	0	0	0	0	0	0	0
	29	0	0	0	0	0	0	0	0	0	0	0	0	0	0
	30	43	0	16	19	0	1	0	432	0	257	19	1	90	0
	31	55	0	22	20	2	1	0	887	0	299	20	27	121	0
Jun	1	56	0	18	20	2	0	0	895	0	430	30	25	96	1
	2	60	0	16	27	1	2	0	1073	0	277	35	7	255	1
	3	11	0	4	3	0	1	0	299	0	83	4	0	147	0
	4	49	0	9	28	0	1	0	826	0	310	126	0	124	0
	5	140	0	11	109	2	0	1	1254	0	336	333	135	84	2
	6	122	0	6	111	1	0	0	806	0	184	289	117	0	1
	7	64	0	3	59	0	1	0	507	1	91	76	40	103	0
	8	119	0	5	109	0	0	1	519	0	138	133	17	0	2
	9	125	1	20	81	3	0	8	1593	7	591	246	195	0	25
	10	427	0	40	343	2	3	18	2594	8	802	1009	95	203	52
	11	1668	0	30	1578	3	4	12	5700	0	676	3771	53	481	31
	12	1252	0	63	1113	5	3	16	4105	6	762	2424	73	365	46
	13	1326	0	54	1140	5	5	43	3832	3	735	2194	58	425	110
	14	192	0	7	156	1	2	14	944	0	368	328	3	89	36
	15	230	1	21	160	1	1	16	1688	12	912	355	6	115	32
	16	265	0	19	197	1	1	19	1450	17	613	456	11	110	43
	17	77	0	17	43	0	1	8	1214	0	807	141	2	124	22
	18	104	0	7	82	0	1	4	902	1	345	223	26	162	11
	19	192	0	12	146	0	0	21	1215	4	463	405	24	5	53
	20	89	0	8	64	0	0	11	631	0	245	177	26	0	29
	21	373	1	8	327	1	13	0	1558	31	381	786	90	33	0
	22	241	0	3	171	1	0	52	963	24	91	394	38	47	192
	23	140	0	5	97	0	2	28	936	9	268	358	4	10	66
	24	89	0	3	52	1	1	24	772	0	177	184	21	93	60
	25	23	0	3	10	0	1	7	519	0	190	64	29	95	16
	26	47	1	5	21	1	2	16	669	18	271	95	29	118	40
	27	32	0	3	11	1	14	0	423	6	168	48	28	38	0
	28	38	0	5	15	1	1	12	729	0	290	83	4	73	36
	29	30	0	2	10	0	8	9	318	2	72	60	2	81	25
	30	48	1	3	27	0	10	4	432	1	133	73	3	37	11

*Recorded to the nearest whole number.

†SB = striped bass; WP = white perch; TC = Atlantic tomcod; BH = blueback herring; AL = alewife; BA = bay anchovy.



Table A-3 (Contd)

		Number/Million m ³ *						Weight (g/million m ³)*							
		All Species Combined	SB [†]	WP	TC	BH	AL	BA	All Species Combined	SB	WP	TC	BH	AL	BA
Jul	1	27	0	2	16	0	3	4	336	0	141	45	0	49	9
	2	82	1	4	19	0	8	44	719	4	243	45	1	36	157
	3	58	1	2	8	0	7	29	626	1	119	40	0	9	106
	4	58	0	2	0	0	2	51	265	6	100	15	0	6	113
	5	48	0	2	1	0	1	41	258	19	77	3	0	2	108
	6	56	1	3	1	0	0	44	492	21	160	5	0	0	124
	7	64	2	1	6	0	0	44	665	37	61	18	0	1	194
	8	121	1	1	16	0	1	95	778	10	101	57	18	4	254
	9	292	2	2	132	1	3	142	1138	29	84	475	80	7	397
	10	142	1	3	64	0	2	66	871	27	154	267	42	67	206
	11	182	0	2	34	0	5	138	760	0	70	145	29	11	433
	12	200	1	9	53	0	8	101	1312	1	336	520	27	55	295
	13	242	1	5	77	1	9	148	1217	1	209	390	31	73	457
	14	148	5	9	21	1	33	72	919	7	266	124	51	81	213
	15	203	6	9	33	0	35	106	1458	67	316	180	29	151	275
	16	205	5	6	34	1	24	129	894	29	81	161	16	54	375
	17	520	24	9	254	6	17	182	2115	41	128	1041	38	34	481
	18	569	40	35	304	7	21	98	3238	81	433	1425	24	46	247
	19	1323	16	27	567	5	38	603	5237	54	185	2413	11	103	1834
	20	1341	23	12	95	19	75	1080	3458	73	234	362	24	152	2180
	21	1022	21	37	104	19	37	761	2986	60	195	376	30	113	1781
	22	1320	20	26	804	7	31	388	5068	43	154	3359	15	120	1020
	23	656	12	22	309	16	19	247	2389	77	161	1171	24	56	635
	24	604	10	19	154	129	13	252	1790	29	102	587	217	46	640
	25	514	10	27	39	6	101	306	1465	21	133	176	16	183	629
	26	103	7	10	17	16	8	30	540	16	153	60	28	14	74
	27	333	22	33	38	16	3	192	1415	38	286	161	36	28	528
	28	269	34	58	79	26	3	23	1327	45	117	282	74	95	57
	29	560	58	39	204	22	12	139	3335	71	326	780	41	71	377
	30	0	0	0	0	0	0	0	0	0	0	0	0	0	0
	31	0	0	0	0	0	0	0	0	0	0	0	0	0	0
Aug	1	0	0	0	0	0	0	0	0	0	0	0	0	0	0
	2	0	0	0	0	0	0	0	0	0	0	0	0	0	0
	3	0	0	0	0	0	0	0	0	0	0	0	0	0	0
	4	0	0	0	0	0	0	0	0	0	0	0	0	0	0
	5	0	0	0	0	0	0	0	0	0	0	0	0	0	0
	6	0	0	0	0	0	0	0	0	0	0	0	0	0	0
	7	0	0	0	0	0	0	0	0	0	0	0	0	0	0
	8	0	0	0	0	0	0	0	0	0	0	0	0	0	0
	9	0	0	0	0	0	0	0	0	0	0	0	0	0	0
	10	0	0	0	0	0	0	0	0	0	0	0	0	0	0
	11	1515	33	288	150	8	9	834	5166	68	742	706	40	30	2493
	12	3118	64	1532	344	38	2	429	12083	112	2791	1758	154	17	13040
	13	901	20	248	61	10	0	409	4590	295	529	385	27	10	1060
	14	1360	10	190	435	24	0	546	5540	53	578	2136	23	0	1448
	15	885	19	138	373	11	3	259	4730	54	320	2085	72	16	672
	16	1064	9	112	405	3	4	416	4654	70	346	1969	5	22	1228
	17	1012	4	55	266	75	1	510	3592	12	181	113	221	6	1426
	18	498	8	33	97	6	0	322	1971	69	178	446	44	0	825
	19	5902	73	584	736	21	14	4132	20334	169	1808	2843	225	115	12433
	20	810	4	43	74	3	1	646	2751	8	207	290	7	9	1829
	21	1010	6	62	97	2	1	792	3310	13	143	396	9	19	2413
	22	805	3	32	72	1	1	657	2635	7	131	233	2	6	2080
	23	773	4	39	79	3	0	614	2833	10	186	274	8	1	1860
	24	434	3	23	41	3	2	348	1482	8	105	130	6	5	1150
	25	617	10	47	105	5	0	374	2449	23	231	481	27	0	1174
	26	859	6	65	91	8	3	589	2992	46	197	404	24	21	1490
	27	476	3	41	27	2	0	365	1697	10	200	87	3	0	991
	28	277	3	35	17	1	0	193	1100	9	196	58	17	0	477
	29	140	0	15	5	2	0	97	746	2	119	15	34	0	287
	30	73	0	5	2	1	0	55	360	1	36	12	2	1	155
	31	173	1	14	5	2	0	129	801	3	49	27	52	0	348

*Recorded to the nearest whole number.

[†]SB = striped bass; WP = white perch; TC = Atlantic tomcod; BH = blueback herring; AL = alewife; BA = bay anchovy.



Table A-3 (Contd)

		Number/Million m ³ *						Weight (g/million m ³)*							
		All Species Combined						All Species Combined							
		SB	WP	TC	BH	AL	BA	SB	WP	TC	BH	AL	BA		
Sep	1	349	1	15	8	2	0	305	1425	3	153	61	62	2	900
	2	114	0	10	4	0	0	82	774	2	49	33	0	0	261
	3	210	1	18	3	0	0	162	1323	3	155	20	1	4	561
	4	670	7	83	43	1	2	452	3569	36	539	379	3	89	1441
	5	975	11	95	256	3	1	332	6683	75	479	1305	21	13	987
	6	1758	30	292	45	5	3	571	12272	161	1161	2375	16	41	1918
	7	1789	16	233	411	6	3	549	14812	104	924	1940	56	54	1663
	8	634	5	72	134	5	2	265	4672	20	373	668	17	21	938
	9	1199	7	177	136	10	5	582	9588	36	1381	843	35	35	1851
	10	654	2	166	73	6	1	271	5148	10	1119	428	57	24	833
	11	1223	21	283	241	12	9	345	9760	73	1436	1570	41	115	1220
	12	1942	14	331	695	8	5	348	12712	71	1151	3249	23	41	953
	13	201	2	19	42	0	0	53	2506	303	210	223	0	0	97
	14	442	5	82	124	5	0	0	3031	56	218	632	7	0	0
	15	475	1	57	307	2	1	62	2583	2	222	1522	6	21	224
	16	1451	9	380	635	6	3	246	7409	67	1163	3058	51	28	854
	17	451	2	69	138	4	0	180	2434	10	287	494	35	5	517
	18	599	2	90	25	3	1	172	3440	23	341	1259	30	16	548
	19	92	0	6	18	0	0	36	928	1	71	111	26	1	108
	20	223	2	16	25	1	0	124	1676	5	135	105	6	8	371
	21	86	0	8	4	1	0	56	427	0	67	16	1	1	171
	22	67	0	6	2	1	0	46	347	3	61	11	5	11	139
	23	84	0	9	5	1	0	58	451	0	85	23	9	1	167
	24	65	0	6	3	1	0	50	336	0	85	29	1	4	123
	25	53	1	15	3	2	0	24	485	3	226	19	57	0	49
	26	27	1	5	1	2	0	14	229	8	32	6	27	14	26
	27	148	2	37	4	48	1	42	703	9	329	26	122	12	83
	28	157	2	44	29	22	0	44	931	9	278	207	89	0	77
	29	60	1	25	5	11	0	9	520	3	146	29	26	1	13
	30	74	1	30	2	17	0	21	282	3	105	7	39	9	38
Oct	1	270	1	41	3	127	0	80	771	6	236	20	298	1	146
	2	581	2	87	3	326	1	136	1515	38	338	21	699	16	220
	3	897	9	284	10	231	12	270	3003	44	1116	83	497	58	376
	4	564	7	127	14	291	6	85	2106	37	611	104	587	47	132
	5	1809	12	257	27	1067	9	372	5171	69	1150	205	2264	40	558
	6	486	3	64	1	355	1	55	1304	23	297	6	815	19	80
	7	649	2	52	1	451	0	128	1467	14	247	8	828	1	177
	8	1450	2	84	1	1141	4	201	3164	9	374	8	2203	18	270
	9	1156	1	106	3	875	1	154	2719	4	428	27	1817	4	232
	10	1197	2	80	1	987	0	107	2721	19	483	5	1925	2	145
	11	1177	1	60	0	994	1	106	2641	6	390	3	1898	7	138
	12	1658	2	88	1	1400	2	146	3771	9	512	12	2870	8	186
	13	1002	2	48	1	874	2	63	2306	81	315	20	1626	7	75
	14	999	1	79	4	861	3	40	2552	9	446	57	1768	29	46
	15	667	1	48	0	578	1	29	1502	36	279	0	1058	4	33
	16	1196	1	79	1	1074	2	20	3022	17	538	9	2195	13	25
	17	177	1	12	0	149	0	9	474	4	51	0	295	0	12
	18	225	0	12	0	164	0	46	708	0	142	0	324	0	54
	19	603	2	57	0	509	0	10	1425	5	390	0	891	0	10
	20	296	0	11	0	227	0	11	500	0	11	0	318	0	23
	21	71	0	3	0	67	0	0	215	0	94	0	117	0	0
	22	0	0	0	0	0	0	0	0	0	0	0	0	0	0
	23	4	0	0	0	2	0	0	4	0	0	0	2	0	0
	24	12	1	3	0	7	0	0	88	7	13	0	10	0	0
	25	7	0	4	0	3	0	0	39	0	35	0	4	0	0
	26	18	0	3	0	12	0	0	143	0	14	0	17	0	0
	27	61	0	14	0	36	0	0	305	0	81	0	56	0	0
	28	84	1	43	1	26	0	0	730	14	523	16	41	0	0
	29	49	0	1	0	45	0	0	200	0	3	0	105	0	0
	30	623	8	165	0	419	3	0	1817	42	881	0	755	11	0
	31	1225	10	357	1	786	4	0	4483	85	2102	25	1395	18	0

*Recorded to the nearest whole number.

†SB = striped bass; WP = white perch; TC = Atlantic tomcod; BH = blueback herring; AL = alewife; BA = bay anchovy.



Table A-3 (Contd)

		Number/Million m ³ *							Weight (g/million m ³)*						
		All Species Combined	SB	WP	TC	BH	AL	BA	All Species Combined	SB	WP	TC	BH	AL	BA
Nov	1	4182	9	710	8	3268	19	0	11898	66	4636	127	5572	80	0
	2	1741	7	638	3	923	7	0	6512	61	3249	64	1721	27	0
	3	2468	6	815	2	1473	12	0	8231	69	4269	47	2514	50	0
	4	5350	9	1527	10	3507	34	0	15296	85	7280	223	5885	112	0
	5	852	1	315	1	466	2	0	2618	7	1413	9	821	6	0
	6	0	0	0	0	0	0	0	0	0	0	0	0	0	0
	7	310	2	97	0	180	1	0	1113	42	517	6	291	6	0
	8	1323	4	415	3	0	6	0	4643	37	2293	59	0	34	0
	9	1251	3	351	2	761	13	0	3996	26	1884	44	1142	52	0
	10	670	1	179	1	389	8	0	2608	9	1123	28	647	39	0
	11	1209	1	347	2	688	22	0	4603	12	2206	31	1157	99	0
	12	730	1	200	3	411	12	0	3248	2	1558	88	765	47	0
	13	514	1	124	2	298	5	0	2313	8	1010	50	520	21	0
	14	331	1	83	1	187	5	0	1159	11	352	26	339	21	0
	15	692	0	80	0	476	8	0	2087	0	393	0	852	27	0
	16	0	0	0	0	0	0	0	0	0	0	0	0	0	0
	17	509	0	250	0	191	1	0	1275	4	404	11	386	4	0
	18	1668	0	324	3	1226	8	0	4976	1	1563	49	2477	36	0
	19	2230	1	335	1	1717	8	0	6452	11	1697	24	3392	31	0
	20	1555	2	202	4	1241	5	0	4506	26	1171	103	2456	23	0
	21	1172	1	117	2	985	6	0	3325	27	602	62	2169	27	0
	22	631	0	101	1	460	10	0	2377	12	955	20	853	44	0
	23	1117	1	104	2	901	10	0	3682	11	1055	73	1662	45	0
	24	1852	1	79	4	1684	3	0	4892	17	648	115	3470	18	0
	25	680	0	22	0	625	1	0	1739	4	161	13	1181	2	0
	26	949	0	48	1	851	0	0	2528	0	333	25	1583	1	0
	27	887	0	49	4	808	1	0	2373	0	337	129	1640	3	0
	28	458	0	93	2	334	2	0	1494	0	540	53	715	9	0
	29	541	1	85	2	427	0	0	1844	6	644	70	867	0	0
	30	1533	1	231	17	1233	4	0	5082	13	1688	449	2428	15	0
Dec	1	2470	5	487	25	1845	10	0	8818	61	3480	675	3326	42	0
	2	868	2	386	25	400	6	0	4729	41	2732	777	716	30	0
	3	802	2	270	5	491	4	0	3263	22	1899	147	846	18	0
	4	275	2	132	10	102	5	0	2025	33	948	322	198	21	0
	5	182	1	97	3	70	1	0	1088	24	623	112	141	6	0
	6	208	2	123	4	65	0	0	1272	31	871	138	138	0	0
	7	155	2	103	4	33	0	0	988	35	608	117	70	1	0
	8	152	1	95	14	26	1	0	1337	13	621	420	49	2	0
	9	101	0	58	7	21	0	0	950	2	312	199	38	1	0
	10	170	2	128	7	23	0	0	1070	24	701	210	47	0	0
	11	98	2	65	7	14	0	0	624	22	353	185	28	0	0
	12	575	2	547	4	4	0	0	2711	21	2430	99	8	0	0
	13	187	1	178	2	1	0	1	828	5	743	36	1	0	0
	14	154	1	138	1	7	0	0	1536	8	1385	40	11	0	0
	15	114	1	103	2	1	0	1	627	14	496	74	2	0	1
	16	145	1	135	3	0	0	0	827	6	730	61	1	0	1
	17	367	1	349	5	1	0	1	2314	9	2096	155	2	0	2
	18	812	2	773	8	1	1	2	4950	20	4223	277	1	10	5
	19	588	12	528	15	0	0	1	4093	259	3193	426	0	1	1
	20	695	15	628	22	0	0	0	4994	245	3731	771	1	0	0
	21	1481	10	1389	38	1	0	0	9154	223	7452	1062	1	0	0
	22	1662	16	1323	177	0	0	0	12270	218	5503	4636	0	0	0
	23	1348	10	1158	115	0	0	0	11508	139	6037	4839	0	0	0
	24	418	6	354	28	0	0	0	3448	78	1761	922	0	0	0
	25	0	0	0	0	0	0	0	0	0	0	0	0	0	0
	26	1404	5	1351	17	0	0	0	7080	36	5959	648	0	0	0
	27	586	4	567	3	0	0	0	2903	41	2543	70	0	0	0
	28	333	2	312	5	0	0	0	2078	13	1367	404	0	0	0
	29	169	1	158	2	0	0	0	921	8	775	88	0	0	0
	30	752	5	718	4	0	0	0	3695	42	3011	186	0	0	0
	31	381	0	371	1	0	0	1	1817	0	1609	60	0	0	0

*Recorded to the nearest whole number

†SB = striped bass; WP = white perch; TC = Atlantic tomcod; BH = blueback herring; AL = alewife; BA = bay anchovy.



Table A-4

Numbers and Weights of Major Impinged Species and All Species Combined
Collected at Indian Point Unit 2 during 1975

Year	Season	Month	Week	Total Number*							Total Weight (g)*						
				All Species Combined							All Species Combined						
				WP†	SB	TC	BH	AL	BA	WP†	SB	TC	BH	AL	BA		
1			1	11629	11433	46	44	1	0	0	55215	52851	393	924	7	0	0
2			2	13012	12778	24	128	1	0	0	69686	63393	208	2686	108	0	0
3			3	1008	837	10	81	0	0	0	6589	3839	141	1456	0	0	0
4			4	3641	3391	41	112	0	1	0	20898	17169	449	2111	0	5	0
5			5	4037	3752	51	82	0	1	0	25868	21832	364	1475	0	7	0
6			6	3443	3152	67	71	2	2	3	36624	32401	618	1084	15	15	6
7			7	15318	14458	358	144	4	20	0	136797	124361	3522	2410	39	276	0
8			8	6754	6449	99	15	3	11	0	42212	39083	830	277	21	110	0
9			9	869	700	31	29	6	1	0	8709	5664	216	515	37	25	0
10			10	685	627	6	5	1	0	0	4237	3649	43	95	8	0	0
11			11	4726	4656	34	3	0	0	1	26283	25243	585	49	0	0	2
12			12	7702	7660	11	2	0	1	0	35502	34894	61	47	0	9	0
13			13	694	653	1	1	0	0	0	7940	7295	9	11	0	0	0
14			14	1276	935	2	3	5	1	0	14383	10883	12	42	15	334	0
15			15	4159	3040	70	2	10	1	0	39443	34156	568	38	34	10	0
16			16	32589	30528	193	14	68	3	0	331237	319179	1433	472	267	411	0
17			17	33019	31342	166	56	76	0	0	465701	442525	1807	1805	665	0	0
18			18	8152	7239	20	2	124	4	0	80421	69416	290	53	415	707	0
19			19	4768	3157	26	138	42	14	6	51243	32042	174	371	1044	2958	21
20			20	4683	2927	17	261	71	32	2	44283	18752	108	438	411	5402	9
21			21	1924	347	4	117	19	16	2	34240	6723	60	162	483	2394	8
22			22	1156	493	1	372	26	23	2	20569	9393	7	491	418	3259	9
23			23	4880	432	6	3920	38	23	131	37638	11403	73	10345	2754	2404	388
24			24	22361	934	9	19595	67	80	558	84340	21555	172	43251	924	7612	1403
25			25	5525	214	10	4217	21	77	644	31601	8949	304	11373	1029	1593	1885
26			26	1131	108	9	501	12	176	241	15743	5806	122	2155	435	2260	631
27			27	2047	64	27	226	3	87	1448	16102	3601	399	799	91	257	4434
28			28	6427	180	76	1884	18	438	3510	35256	6641	624	8341	1324	2056	10317
29			29	28746	685	674	9829	292	1115	14843	104688	6448	1740	41474	729	2846	36122
30			30	12060	817	512	3183	969	690	4975	45507	4843	1132	12210	1831	2020	12207
31			31	0	0	0	0	0	0	0	0	0	0	0	0	0	0
32			32	20194	8232	423	2164	207	46	5098	75649	15803	775	10836	868	193	15347
33			33	28178	3434	328	7699	653	50	13132	118510	9800	2154	37520	2083	294	36363
34			34	21780	1298	149	2317	105	34	16379	75538	4908	489	9317	358	267	48634
35			35	7099	604	45	302	47	6	5424	30508	3571	134	1305	760	16	15105
36			36	31304	4157	329	6284	127	71	12486	229668	21282	1895	32782	655	1086	39973
37			37	25355	5386	219	8363	156	91	5706	169359	23092	1301	42575	799	1071	18402
38			38	6828	896	22	1985	48	10	2772	41122	4440	185	9206	494	175	8352
39			39	1863	505	20	134	316	8	687	11104	3819	118	928	1169	154	1401
40			40	20517	3446	140	236	11298	111	4367	59602	15179	903	1785	23724	686	6601
41			41	31951	2032	37	39	26327	44	3057	73416	10910	520	466	52099	257	4105
42			42	8214	561	11	3	7232	12	251	20020	3696	233	35	14118	71	302
43			43	152	55	2	1	70	0	0	1642	516	16	12	106	0	0
44			44	44514	11603	133	69	30003	205	1	140740	64404	1154	1309	51839	833	1
45			45	22047	6556	52	43	9908	212	0	78130	37119	703	917	16069	980	0
46			46	14961	3785	12	37	9261	121	0	52351	19565	101	856	17826	517	0
47			47	33706	3567	24	54	27716	156	1	98516	23206	392	1461	55252	691	1
48			48	30674	5165	29	288	23866	83	0	105006	36824	421	8246	45946	374	0
49			49	7090	3276	36	176	3133	36	0	40051	21623	569	5356	5716	167	0
50			50	5623	5046	33	100	197	0	8	32036	26648	390	2754	379	0	9
51			51	20301	18109	191	989	11	4	19	141498	96268	3256	31474	17	41	30
52			52	14613	13940	78	199	1	0	0	78165	62114	758	7945	1	0	0
53			53	1047	1018	0	4	0	0	2	4993	4420	0	164	0	0	1
1	Winter			32932	31858	162	429	2	2	0	175991	157433	1484	8313	115	12	0
2	Spring			26488	24875	557	265	11	34	3	223393	201354	5193	4382	82	426	6
3	Summer			13772	13496	59	23	5	1	1	73497	69277	753	445	38	9	2
4	Fall			73034	67665	440	76	184	6	0	877133	830749	3885	2393	1060	969	0
5				18512	12506	60	698	246	77	10	199049	112665	583	1209	2554	12542	38
6				34280	1831	34	28351	149	354	1559	176820	50343	671	67188	5280	15609	4275
7				49403	1757	1289	15195	1282	2343	24793	203092	22178	3895	63030	3975	7403	63121
8				75203	13458	939	12430	1003	132	38316	290573	33189	3527	58564	3787	760	110302
9				67398	11054	596	16818	656	184	23368	460885	53526	3524	85905	3399	2496	73275
10				64535	7158	220	283	47319	179	7675	168084	36531	1927	2367	94315	1070	11008
11				131664	26901	198	333	91232	715	2	418679	155406	2200	8264	169820	3104	2
12				59211	44100	360	1622	10472	90	29	339403	230555	5289	52149	18957	443	40
1975				646432	256659	4914	76523	152561	4117	95756	3606599	1953196	32931	354209	303382	44843	262069

*Recorded to the nearest whole number.

†WP = white perch; SP = striped bass; TC = Atlantic tomcod; BH = blueback herring; AL = alewife; BA = bay anchovy.



Table A-5

Numbers and Weights of Major Impinged Species and All Species Combined
Collected at Indian Point Unit 1 during 1975

	Total Number*							Total Weight (g)*						
	All Species Combined	WP†	SB	TC	BH	AL	BA	All Species Combined	WP	SB	TC	BH	AL	BA
Week 1	3533	3224	37	213	2	2	0	22997	16522	536	5446	36	177	0
2	1919	1808	6	84	1	0	0	10266	7706	249	1939	10	0	0
3	342	260	2	68	0	0	0	4783	1119	20	1687	0	0	0
4	1097	736	53	146	1	5	1	14641	7770	428	2370	31	89	1
5	3794	3467	58	104	5	0	0	41746	35470	881	1971	60	0	0
6	2541	2055	61	197	9	2	0	28794	19525	540	3214	458	17	0
7	10782	9622	511	175	10	37	0	153338	128423	5733	2857	184	399	0
8	2943	2681	76	38	3	8	0	31271	26963	729	720	28	295	0
9	1267	1057	50	13	9	4	0	17132	10205	539	232	62	79	0
10	1285	1078	25	19	0	1	0	13162	8275	301	334	0	11	0
11	3963	3734	51	15	5	6	0	36658	31275	651	275	78	389	0
12	818	761	7	11	0	1	0	5583	4299	42	217	0	432	0
13	178	113	2	2	0	0	0	2090	1349	118	30	0	0	0
14	182	113	0	4	0	0	0	1928	1306	0	73	0	0	0
15	723	306	6	5	4	2	0	5250	3626	36	80	14	15	0
16	6843	6033	57	16	50	3	0	75645	68484	509	403	531	691	0
17	4950	4613	39	6	21	6	0	69095	63192	390	146	429	1276	0
18	0	0	0	0	0	0	0	0	0	0	0	0	0	0
19	691	503	2	9	5	5	0	3662	1759	7	9	22	603	0
20	535	274	3	40	30	7	0	6354	1556	15	40	159	1341	0
21	0	0	0	0	0	0	0	0	0	0	0	0	0	0
22	16	7	0	1	0	4	0	1179	255	0	1	0	567	0
23	107	7	0	62	4	1	12	870	100	0	123	112	182	45
24	552	76	0	360	17	4	4	6424	1710	0	892	755	411	13
25	377	34	0	261	1	9	35	2573	860	0	804	5	359	88
26	21	0	0	19	0	1	1	185	0	0	39	0	143	3
27	3	0	0	1	0	1	1	96	0	0	94	0	1	1
28	19	0	0	3	0	0	15	71	0	0	13	0	0	54
29	0	0	0	0	0	0	0	0	0	0	0	0	0	0
30	227	27	1	65	14	8	83	1244	336	1	223	37	77	210
31	220	49	15	59	4	4	58	1855	556	19	300	9	38	120
32	136	25	1	67	0	1	23	968	95	4	356	0	2	59
33	0	0	0	0	0	0	0	0	0	0	0	0	0	0
34	0	0	0	0	0	0	0	0	0	0	0	0	0	0
35	33	3	0	7	1	0	15	132	39	0	24	2	0	39
36	0	0	0	0	0	0	0	0	0	0	0	0	0	0
37	0	0	0	0	0	0	0	0	0	0	0	0	0	0
38	0	0	0	0	0	0	0	0	0	0	0	0	0	0
39	0	0	0	0	0	0	0	0	0	0	0	0	0	0
40	0	0	0	0	0	0	0	0	0	0	0	0	0	0
41	0	0	0	0	0	0	0	0	0	0	0	0	0	0
42	0	0	0	0	0	0	0	0	0	0	0	0	0	0
43	0	0	0	0	0	0	0	0	0	0	0	0	0	0
44	0	0	0	0	0	0	0	0	0	0	0	0	0	0
45	0	0	0	0	0	0	0	0	0	0	0	0	0	0
46	0	0	0	0	0	0	0	0	0	0	0	0	0	0
47	0	0	0	0	0	0	0	0	0	0	0	0	0	0
48	0	0	0	0	0	0	0	0	0	0	0	0	0	0
49	0	0	0	0	0	0	0	0	0	0	0	0	0	0
50	0	0	0	0	0	0	0	0	0	0	0	0	0	0
51	0	0	0	0	0	0	0	0	0	0	0	0	0	0
52	0	0	0	0	0	0	0	0	0	0	0	0	0	0
53	0	0	0	0	0	0	0	0	0	0	0	0	0	0
Month 1	10424	9301	152	584	8	7	1	91791	67868	1910	12721	128	266	1
2	17489	15367	693	449	30	51	0	230301	183777	7684	7636	726	790	0
3	6495	5882	93	52	7	8	0	59783	46715	1170	935	93	832	0
4	12752	11111	103	31	75	11	0	152504	137149	938	702	974	1982	0
5	1226	777	5	49	35	12	0	10016	3325	22	49	181	1944	0
6	1073	124	0	703	22	19	52	11231	2925	0	1859	872	1662	149
7	392	61	10	119	17	10	121	2399	730	11	561	45	81	317
8	246	43	7	83	2	4	74	1967	296	13	449	3	37	166
9	0	0	0	0	0	0	0	0	0	0	0	0	0	0
10	0	0	0	0	0	0	0	0	0	0	0	0	0	0
11	0	0	0	0	0	0	0	0	0	0	0	0	0	0
12	0	0	0	0	0	0	0	0	0	0	0	0	0	0
Season Winter	34715	30741	939	1090	45	66	1	384750	300437	10767	21390	947	1888	1
Spring	14346	11787	107	498	131	32	16	168118	140462	957	1669	2022	5086	58
Summer	1036	138	17	482	20	24	231	7124	1886	24	1853	53	620	574
Fall	0	0	0	0	0	0	0	0	0	0	0	0	0	0
Year 1975	50097	42666	1063	2070	196	122	248	559992	442785	11748	24912	3022	7594	633

*Recorded to the nearest whole number.

† WP = white perch; SB = striped bass; TC = Atlantic tomcod; BH = blueback herring; AL = alewife; BA = bay anchovy.



Table A-6

Numbers and Weights of Major Impinged Species per 1,000,000 m³
of Water Pumped at Unit 1 during 1975

	Total Number*							Total Weight (g)*						
	All Species Combined	WP†	SB	TC	BH	AL	BA	All Species Combined	WP	SB	TC	BH	AL	BA
Week 1	2211	2018	23	133	1	1	0	14393	10340	335	3408	23	111	0
2	1360	1281	4	60	1	0	0	7275	5461	176	1374	7	0	0
3	197	150	1	39	0	0	0	2759	646	12	973	0	0	0
4	519	348	25	69	0	2	0	6947	3680	203	1127	15	42	0
5	3762	3460	58	92	4	0	0	41365	36417	734	1648	53	0	0
6	1535	1241	37	119	5	1	0	17390	11792	326	1941	277	10	0
7	5651	5043	268	92	5	19	0	80373	67313	3005	1498	96	209	0
8	1543	1405	40	20	2	4	0	16391	14133	382	377	15	155	0
9	660	551	26	7	5	2	0	8929	5319	281	121	32	41	0
10	670	562	13	10	0	1	0	6860	4313	157	174	0	6	0
11	2157	2032	28	8	3	3	0	19951	17021	354	150	42	212	0
12	487	453	4	7	0	1	0	3325	2561	25	129	0	257	0
13	106	68	1	1	0	0	0	1249	806	70	18	0	0	0
14	108	67	0	2	0	0	0	1145	776	0	43	0	0	0
15	431	182	4	3	2	1	0	3127	2160	21	48	8	9	0
16	2004	1767	17	5	15	1	0	22151	20054	149	118	155	202	0
17	3153	2938	25	4	13	4	0	44013	40253	248	93	273	813	0
18	0	0	0	0	0	0	0	0	0	0	0	0	0	0
19	289	211	1	4	2	2	0	1534	636	3	4	9	253	0
20	195	100	1	15	11	3	0	2313	570	5	15	58	488	0
21	0	0	0	0	0	0	0	0	0	0	0	0	0	0
22	13	5	0	1	0	3	0	926	200	0	1	0	445	0
23	95	6	0	55	4	1	11	776	89	0	110	100	162	40
24	229	32	0	149	7	2	2	2663	709	0	370	313	170	5
25	209	19	0	145	1	5	19	1426	477	0	446	3	199	49
26	27	0	0	25	0	1	1	240	0	0	51	0	185	4
27	20	0	0	7	0	7	7	636	0	0	622	0	7	7
28	32	0	0	5	0	0	26	121	0	0	22	0	0	92
29	0	0	0	0	0	0	0	0	0	0	0	0	0	0
30	145	17	1	41	9	5	53	794	214	1	142	24	49	134
31	107	24	7	29	2	2	28	903	271	9	146	4	18	58
32	248	46	2	122	0	2	42	1763	173	7	648	0	4	107
33	0	0	0	0	0	0	0	0	0	0	0	0	0	0
34	0	0	0	0	0	0	0	0	0	0	0	0	0	0
35	66	6	0	14	2	0	30	264	78	0	48	4	0	78
36	0	0	0	0	0	0	0	0	0	0	0	0	0	0
37	0	0	0	0	0	0	0	0	0	0	0	0	0	0
38	0	0	0	0	0	0	0	0	0	0	0	0	0	0
39	0	0	0	0	0	0	0	0	0	0	0	0	0	0
40	0	0	0	0	0	0	0	0	0	0	0	0	0	0
41	0	0	0	0	0	0	0	0	0	0	0	0	0	0
42	0	0	0	0	0	0	0	0	0	0	0	0	0	0
43	0	0	0	0	0	0	0	0	0	0	0	0	0	0
44	0	0	0	0	0	0	0	0	0	0	0	0	0	0
45	0	0	0	0	0	0	0	0	0	0	0	0	0	0
46	0	0	0	0	0	0	0	0	0	0	0	0	0	0
47	0	0	0	0	0	0	0	0	0	0	0	0	0	0
48	0	0	0	0	0	0	0	0	0	0	0	0	0	0
49	0	0	0	0	0	0	0	0	0	0	0	0	0	0
50	0	0	0	0	0	0	0	0	0	0	0	0	0	0
51	0	0	0	0	0	0	0	0	0	0	0	0	0	0
52	0	0	0	0	0	0	0	0	0	0	0	0	0	0
53	0	0	0	0	0	0	0	0	0	0	0	0	0	0
Month 1	1383	1234	20	78	1	1	0	12182	9006	254	1689	17	35	0
2	2637	2319	105	66	4	8	0	34784	27926	1144	1104	109	120	0
3	814	738	12	7	1	1	0	7496	5858	147	117	12	104	0
4	1486	1295	12	4	9	1	0	17769	15980	109	82	113	231	0
5	223	142	1	9	6	2	0	1824	606	4	9	33	354	0
6	153	18	0	100	3	3	7	1598	416	0	265	124	237	21
7	125	19	3	38	5	3	38	763	232	3	178	14	26	101
8	109	19	3	37	1	2	33	869	131	6	198	1	16	73
9	0	0	0	0	0	0	0	0	0	0	0	0	0	0
10	0	0	0	0	0	0	0	0	0	0	0	0	0	0
11	0	0	0	0	0	0	0	0	0	0	0	0	0	0
12	0	0	0	0	0	0	0	0	0	0	0	0	0	0
Year Season														
Winter	1737	1544	48	55	2	3	0	19438	15269	543	1076	49	76	0
Spring	726	596	5	24	6	2	1	8305	6883	52	94	94	258	3
Summer	130	17	2	60	3	3	29	892	236	3	232	7	78	72
Fall	0	0	0	0	0	0	0	0	0	0	0	0	0	0
Year 1975	1027	875	22	42	4	3	5	11485	9104	238	505	62	156	13

*Recorded to the nearest whole number.

†WP = white perch; SB = striped bass; TC = Atlantic tomcod; BH = blueback herring; AL = alewife; BA = bay anchovy.



Table A-7

Numbers and Weights of Major Impinged Species per 1,000,000 m³
of Water Pumped at Unit 2 during 1975

	Total Number*							Total Weight (g)*						
	All Species Combined	WP†	SB	TC	BH	AL	BA	All Species Combined	WP	SB	TC	BH	AL	BA
1	3355	3293	15	14	0	0	0	16612	15850	133	289	0	0	0
2	1734	1703	3	17	0	0	0	9288	8449	28	358	14	0	0
3	111	92	1	9	0	0	0	724	422	15	160	0	0	0
4	380	354	4	12	0	0	0	2182	1793	47	220	0	1	0
5	569	530	7	11	0	0	0	3682	3104	52	208	0	1	0
6	358	328	7	7	0	0	0	3809	3370	64	113	2	2	1
7	1593	1504	37	15	0	2	0	14227	12933	366	251	4	29	0
8	663	633	10	1	0	1	0	4143	3836	81	27	2	11	0
9	99	80	4	3	1	0	0	990	644	25	59	4	3	0
10	228	209	2	2	0	0	0	1410	1214	14	32	3	0	0
11	0	0	0	0	0	0	0	0	0	0	0	0	0	0
12	3526	3509	5	1	0	0	0	16177	15910	28	22	0	4	0
13	167	157	0	0	0	0	0	1909	1754	2	3	0	0	0
14	152	111	0	0	1	0	0	1711	1294	1	5	2	40	0
15	319	233	5	0	1	0	0	3027	2621	44	3	3	1	0
16	2145	2010	13	1	4	0	0	21808	21013	94	31	18	27	0
17	1789	1698	9	3	4	0	0	25230	23974	98	98	36	0	0
18	529	469	1	0	8	0	0	5211	4498	19	4	27	47	0
19	247	164	1	7	2	1	0	2657	1661	9	19	54	153	1
20	233	146	1	13	4	2	0	2207	935	5	22	20	269	0
21	94	17	0	6	1	1	0	1679	330	3	8	24	117	0
22	41	14	0	16	1	1	0	668	253	0	20	12	130	0
23	187	17	0	150	1	1	5	1440	436	3	396	105	92	15
24	890	37	0	780	3	3	22	3355	858	7	1721	37	303	56
25	209	8	0	159	1	3	24	1195	338	11	430	39	60	71
26	44	4	0	19	0	7	9	611	225	5	84	17	88	24
27	88	3	1	10	0	4	63	696	156	17	35	4	11	192
28	246	7	3	72	1	17	134	1351	254	24	320	51	79	395
29	1115	27	26	381	11	43	576	4062	250	68	1609	28	110	1402
30	525	36	22	139	42	30	217	1982	211	49	532	80	88	532
31	0	0	0	0	0	0	0	0	0	0	0	0	0	0
32	2915	1188	61	312	30	7	736	10920	2281	112	1564	125	28	2215
33	1329	162	15	363	31	2	620	5591	462	102	1770	98	14	1716
34	906	54	6	96	4	1	682	3143	204	20	388	15	11	2024
35	284	24	2	12	2	0	217	1222	143	5	52	30	1	605
36	1267	168	13	254	5	3	505	9296	861	77	1327	27	44	1618
37	1463	311	13	483	9	5	329	9771	1332	75	2456	46	62	1062
38	297	39	1	86	2	0	121	1789	193	8	400	21	8	363
39	100	27	1	7	17	0	37	594	204	6	50	63	8	75
40	984	165	7	11	542	5	210	2860	728	43	86	1138	33	317
41	1524	97	2	2	1255	2	146	3501	520	25	22	2484	12	196
42	1345	92	2	0	1185	2	41	3279	605	38	6	2312	12	49
43	199	72	3	1	92	0	0	2152	676	21	16	139	0	0
44	3544	924	11	5	2388	16	0	11204	5127	92	104	4127	66	0
45	1166	347	3	2	524	11	0	4133	1963	37	49	850	52	0
46	990	247	1	3	620	8	0	3449	1289	6	58	1197	35	0
47	1816	192	1	3	1493	8	0	5307	1250	21	79	2977	37	0
48	1370	231	1	13	1066	4	0	4691	1645	19	368	2053	17	0
49	348	161	2	8	152	2	0	1985	1072	29	258	278	9	0
50	250	224	1	4	9	0	0	1422	1183	17	122	17	0	0
51	1238	1104	12	60	1	0	1	8626	5869	198	1919	1	2	2
52	627	593	4	10	0	0	0	3462	2640	37	396	0	0	0
53	457	445	0	2	0	0	1	2181	1931	0	72	0	0	0
1	913	881	5	13	0	0	0	4976	4430	44	244	3	0	0
2	753	707	16	7	0	1	0	6367	5739	148	124	2	12	0
3	624	610	2	1	0	0	0	3249	3030	12	28	3	1	0
4	1248	1157	8	1	3	0	0	14994	14201	66	41	18	17	0
5	217	146	1	8	3	1	0	2293	1284	7	14	29	146	0
6	311	17	0	257	1	3	14	1603	456	6	609	48	142	39
7	486	17	13	150	13	23	244	1999	218	38	620	39	73	621
8	1071	192	13	177	14	2	546	4139	473	50	834	54	11	1571
9	744	122	7	186	7	2	258	5085	591	39	948	37	28	808
10	1265	140	4	6	928	4	150	3295	716	38	46	1849	21	216
11	1652	337	2	4	1146	9	0	5248	1948	28	104	2134	39	0
12	663	483	4	19	126	1	0	3849	2564	62	613	227	5	0
Year														
Season														
Winter	791	755	9	9	0	0	0	5318	4767	88	166	3	6	0
Spring	591	412	2	117	3	1	3	5860	4778	23	275	35	120	9
Summer	703	93	10	174	10	11	310	3512	425	41	780	41	51	885
Fall	1026	298	3	15	596	4	41	3762	1631	38	275	1135	20	74
1975	782	302	6	94	188	5	118	4367	2335	40	435	374	55	324

*Recorded to the nearest whole number.

†WP = white perch; SB = striped bass; TC = Atlantic tomcod; BH = blueback herring; AL = alewife; BA = bay anchovy.



Table A-9

Length Strata Distribution of Key Species Subsampled from Impingement Collections at Unit 2 during 1975

Date (1975)	Length Class	Striped Bass						Atlantic Tomcod						White Perch													
		No.	\bar{x}	SE	Min.	Max.	No.	\bar{x}	SE	Min.	Max.	No.	\bar{x}	SE	Min.	Max.	No.	\bar{x}	SE	Min.	Max.						
Jan 1	1	25	93.8	3.3	60	123	25	8.6	0.8	2	18	179	25	22.0	2.8	4	75	25	67.2	2.2	53	92	25	3.9	0.5	1	10
	2	0	0.0	0.0	0	0	0	0.0	0.0	0	0	0	0	0.0	0.0	0	0	0	122.9	2.4	105	149	25	26.7	1.9	15	47
	3	2	167.5	11.5	156	179	0	54.5	12.5	42	67	0	0	0.0	0.0	0	0	0	172.0	3.5	150	225	24	78.4	5.6	51	182
	4	0	0.0	0.0	0	0	0	0.0	0.0	0	0	0	0	0.0	0.0	0	0	0	0.0	0.0	0	0	0	0.0	0.0	0	0
Jan 15	1	25	87.0	2.8	65	120	25	7.1	0.7	2	18	169	25	20.0	1.4	11	39	25	66.2	1.8	46	84	25	3.7	0.3	1	8
	2	1	137.0	0.0	137	137	1	28.0	0.0	28	28	0	0	0.0	0.0	0	0	0	120.8	2.5	108	149	25	26.8	2.3	15	53
	3	3	224.0	12.3	205	247	3	121.7	23.7	95	169	0	0	0.0	0.0	0	0	0	173.4	2.6	151	201	25	79.7	4.8	53	143
	4	0	0.0	0.0	0	0	0	0.0	0.0	0	0	0	0	0.0	0.0	0	0	0	0.0	0.0	0	0	0	0.0	0.0	0	0
Feb 1	1	25	93.3	3.0	65	125	25	8.5	0.8	3	19	195	25	17.7	2.3	9	65	25	63.9	2.3	47	90	25	3.2	0.4	1	9
	2	0	0.0	0.0	0	0	0	0.0	0.0	0	0	0	0	0.0	0.0	0	0	0	126.5	2.0	105	146	25	28.4	1.7	15	45
	3	1	161.0	0.0	161	161	1	50.0	0.0	50	50	0	0	0.0	0.0	0	0	0	177.5	3.9	151	241	25	92.2	8.3	49	199
	4	2	256.0	1.0	255	257	2	171.5	4.5	167	176	0	0	0.0	0.0	0	0	0	0.0	0.0	0	0	0	0.0	0.0	0	0
Feb 15	1	25	98.6	3.2	74	134	25	9.8	1.0	4	22	187	25	16.4	1.6	9	45	25	66.4	1.4	52	78	25	3.5	0.2	1	6
	2	2	142.0	0.0	142	142	2	26.5	1.5	25	28	0	0	0.0	0.0	0	0	0	125.6	2.6	99	149	25	30.9	2.1	14	50
	3	6	169.0	2.3	164	178	6	39.8	3.3	25	49	0	0	0.0	0.0	0	0	0	178.0	3.8	153	222	24	93.9	7.8	51	196
	4	0	0.0	0.0	0	0	0	0.0	0.0	0	0	0	0	0.0	0.0	0	0	0	0.0	0.0	0	0	0	0.0	0.0	0	0
Mar 1	1	12	92.6	3.7	71	110	12	8.0	0.9	4	12	176	14	20.1	2.1	10	35	25	69.3	1.5	53	82	25	4.2	0.3	2	7
	2	0	0.0	0.0	0	0	0	0.0	0.0	0	0	0	0	0.0	0.0	0	0	0	121.0	2.7	98	150	24	27.0	2.3	14	59
	3	0	0.0	0.0	0	0	0	0.0	0.0	0	0	0	0	0.0	0.0	0	0	0	175.6	7.8	153	216	8	84.8	10.0	54	141
	4	1	333.0	0.0	333	333	1	393.0	0.0	393	393	0	0	0.0	0.0	0	0	0	0.0	0.0	0	0	0	0.0	0.0	0	0
Mar 15	1	0	0.0	0.0	0	0	0	0.0	0.0	0	0	0	0	0.0	0.0	0	0	0	0.0	0.0	0	0	0	0.0	0.0	0	0
	2	25	85.9	2.2	72	116	25	5.8	0.5	3	14	145	5	15.0	1.3	11	19	25	91.8	5.1	63	136	25	12.4	2.1	3	36
	3	0	0.0	0.0	0	0	0	0.0	0.0	0	0	0	0	0.0	0.0	0	0	0	164.0	2.2	151	192	25	61.3	2.2	46	87
	4	0	0.0	0.0	0	0	0	0.0	0.0	0	0	0	0	0.0	0.0	0	0	0	169.4	2.3	152	195	25	73.7	3.5	44	109
Apr 1	1	0	0.0	0.0	0	0	0	0.0	0.0	0	0	0	0	0.0	0.0	0	0	0	0.0	0.0	0	0	0	0.0	0.0	0	0
	2	24	97.7	2.9	75	127	24	9.1	0.8	3	20	140	4	11.0	3.2	2	17	25	87.9	4.3	58	119	25	9.7	1.5	2	24
	3	0	0.0	0.0	0	0	0	0.0	0.0	0	0	0	0	0.0	0.0	0	0	0	164.2	2.2	151	192	25	61.3	2.2	46	87
	4	0	0.0	0.0	0	0	0	0.0	0.0	0	0	0	0	0.0	0.0	0	0	0	253.0	0.0	253	253	1	238.0	0.0	238	238
Apr 15	1	0	0.0	0.0	0	0	0	0.0	0.0	0	0	0	0	0.0	0.0	0	0	0	0.0	0.0	0	0	0	0.0	0.0	0	0
	2	25	93.7	2.6	71	128	25	8.3	0.7	4	20	149	7	25.6	3.0	15	38	25	101.8	5.6	55	150	25	17.7	2.5	2	50
	3	1	194.0	0.0	194	194	1	194.0	0.0	194	194	0	0	56.0	5.2	45	68	25	172.4	2.9	152	205	25	79.0	4.1	52	134
	4	0	0.0	0.0	0	0	0	0.0	0.0	0	0	0	0	0.0	0.0	0	0	0	0.0	0.0	0	0	0	0.0	0.0	0	0
May 1	1	0	0.0	0.0	0	0	0	0.0	0.0	0	0	0	0	0.0	0.0	0	0	0	0.0	0.0	0	0	0	0.0	0.0	0	0
	2	24	86.0	3.4	67	147	24	6.9	1.3	3	35	138	2	18.0	3.0	15	21	25	97.4	5.5	57	137	25	14.4	2.2	3	36
	3	0	0.0	0.0	0	0	0	0.0	0.0	0	0	0	0	0.0	0.0	0	0	0	175.7	3.0	152	212	25	78.3	4.8	48	154
	4	0	0.0	0.0	0	0	0	0.0	0.0	0	0	0	0	0.0	0.0	0	0	0	261.0	1.0	260	262	2	262.5	42.5	220	305
May 15	1	0	0.0	0.0	0	0	0	0.0	0.0	0	0	0	0	0.0	0.0	0	0	0	0.0	0.0	0	0	0	0.0	0.0	0	0
	2	10	87.8	5.5	73	123	10	7.5	1.8	4	22	146	2	28.5	5.5	23	34	25	60.6	1.3	50	77	25	2.7	0.2	1	6
	3	0	0.0	0.0	0	0	0	0.0	0.0	0	0	0	0	37.5	0.5	37	38	25	178.0	3.4	153	208	25	82.8	5.4	48	133
	4	0	0.0	0.0	0	0	0	0.0	0.0	0	0	0	0	0.0	0.0	0	0	0	0.0	0.0	0	0	0	0.0	0.0	0	0
Jun 1	1	0	0.0	0.0	0	0	0	0.0	0.0	0	0	0	0	0.0	0.0	0	0	0	0.0	0.0	0	0	0	0.0	0.0	0	0
	2	10	102.9	6.9	52	132	10	11.5	1.9	4	24	66	25	1.2	0.1	1	2	0	0.0	0.0	0	0	0	0.0	0.0	0	0
	3	0	0.0	0.0	0	0	0	0.0	0.0	0	0	0	0	53.2	3.0	24	84	25	180.0	3.1	151	213	25	73.0	4.1	34	120
	4	0	0.0	0.0	0	0	0	0.0	0.0	0	0	0	0	0.0	0.0	0	0	0	258.0	0.0	258	258	1	276.0	0.0	276	276
Jun 15	1	3	31.3	2.0	28	35	3	1.0	0.0	1	4	78	25	1.7	0.1	1	4	0	0.0	0.0	0	0	0	0.0	0.0	0	0
	2	13	113.2	5.2	84	139	13	13.9	2.1	5	25	148	7	33.9	7.1	13	61	25	101.4	5.4	70	150	25	15.4	2.4	4	43
	3	3	193.0	6.6	180	201	3	71.0	7.5	63	86	207	24	54.0	3.0	33	90	25	180.0	3.6	152	218	25	79.7	5.6	42	145
	4	0	0.0	0.0	0	0	0	0.0	0.0	0	0	0	0	0.0	0.0	0	0	0	0.0	0.0	0	0	0	0.0	0.0	0	0



Table A-9 (Contd)

Date (1975)	Length Class	Striped Bass						Atlantic Tomcod						White Perch																	
		No.	Length SE	Min.	Max.	No.	Weight SE	No.	Length SE	Min.	Max.	No.	Weight SE	No.	Length SE	Min.	Max.	No.	Weight SE												
Jul 1	1	25	36.2	1.4	24	48	1.0	0.0	1	1	25	71.1	0.8	62	76	25	2.6	0.1	2	4	1	45.0	0.0	45	45	1	1.0	0.0	1	1	
	2	5	128.6	4.8	118	145	17.2	2.9	10	25	2	145.5	0.5	145	146	2	22.0	1.0	21	23	25	105.9	3.5	68	140	25	15.2	1.6	8	42	
	3	6	208.8	12.0	168	245	80.2	15.7	28	126	16	183.4	4.1	156	211	16	57.0	4.2	31	91	25	182.7	3.9	155	224	25	77.3	5.4	37	134	
	4	0	0.0	0.0	0	0	0.0	0.0	0	0	0	0.0	0.0	0	0	0	0.0	0.0	0	0	0	0.0	0.0	0	0	0	0.0	0.0	0	0	0
Jul 15	1	25	43.8	0.6	40	51	1.4	0.1	1	3	25	81.0	1.8	60	94	25	5.3	0.3	3	8	25	44.1	0.6	39	49	25	1.0	0.0	1	1	
	2	19	127.9	2.6	104	150	16.4	0.9	8	25	145.5	4.5	141	150	2	27.5	5.5	22	33	25	94.1	2.6	73	134	25	11.1	1.0	5	30		
	3	11	188.8	9.3	155	250	58.4	10.2	28	123	25	176.6	3.4	153	213	25	50.1	2.8	30	78	25	181.5	2.6	151	207	25	67.7	3.6	35	110	
	4	0	0.0	0.0	0	0	0.0	0.0	0	0	0	0.0	0.0	0	0	0	0.0	0.0	0	0	0	0.0	0.0	0	0	0	0.0	0.0	0	0	0
Aug 1	1	25	62.4	1.0	55	82	2.4	0.2	1	5	25	79.6	1.8	63	101	25	3.9	0.3	2	9	25	58.3	1.6	41	74	25	2.3	0.2	1	5	
	2	14	132.0	3.6	113	148	22.3	2.6	11	39	6	145.8	1.4	141	150	6	22.3	1.3	17	25	25	112.4	3.3	91	147	25	18.0	1.7	8	38	
	3	16	176.4	7.5	151	240	49.6	3.6	32	77	25	175.7	3.6	154	219	25	42.2	2.6	24	65	25	183.6	3.7	154	228	25	68.9	5.6	32	166	
	4	2	254.0	1.0	253	255	92.5	12.5	80	105	0	0.0	0.0	0	0	0	0.0	0.0	0	0	0	0.0	0.0	0	0	0	0.0	0.0	0	0	0
Aug 15	1	25	65.9	1.6	51	78	2.8	0.2	1	5	25	84.3	2.9	61	109	25	5.1	0.5	2	9	25	56.4	1.8	45	78	25	2.0	0.3	1	6	
	2	0	0.0	0.0	0	0	0.0	0.0	0	0	1	150.0	0.0	150	150	1	22.0	0.0	22	22	25	115.3	2.6	99	145	25	19.6	1.8	10	46	
	3	2	210.0	33.0	177	243	71.0	12.0	59	83	25	176.0	2.3	154	197	25	40.6	2.8	28	94	25	185.5	4.0	151	223	25	78.3	6.0	41	164	
	4	0	0.0	0.0	0	0	0.0	0.0	0	0	0	0.0	0.0	0	0	0	0.0	0.0	0	0	0	0.0	0.0	0	0	0	0.0	0.0	0	0	0
Sep 1	1	24	78.3	1.8	61	93	4.3	0.3	2	8	25	81.1	2.5	62	110	25	4.0	0.4	2	8	25	54.1	1.5	40	79	25	1.8	0.2	1	5	
	2	2	126.5	14.5	112	141	20.0	7.0	13	27	2	147.5	2.5	145	150	2	21.5	1.5	20	23	25	126.1	2.8	101	149	25	26.5	1.8	13	47	
	3	2	165.0	0.0	165	165	42.5	1.5	41	44	25	178.6	2.9	157	209	25	39.9	2.4	25	66	25	181.2	3.8	152	237	25	70.5	4.9	44	148	
	4	3	304.0	16.9	277	335	214.7	31.3	179	277	0	0.0	0.0	0	0	0	0.0	0.0	0	0	0	0.0	0.0	0	0	0	0.0	0.0	0	0	0
Sep 15	1	25	77.7	3.5	60	116	4.9	0.7	2	13	25	84.9	1.9	71	102	25	4.6	0.4	2	9	25	62.6	2.1	48	85	25	3.1	0.2	2	7	
	2	0	0.0	0.0	0	0	0.0	0.0	0	0	0	0.0	0.0	0	0	0	0.0	0.0	0	0	25	126.6	2.4	108	150	25	26.8	1.6	15	46	
	3	1	160.0	0.0	160	160	30.0	0.0	30	30	23	188.0	4.2	157	223	23	47.9	3.5	17	79	25	179.4	4.3	154	246	25	69.9	6.3	33	194	
	4	0	0.0	0.0	0	0	0.0	0.0	0	0	0	0.0	0.0	0	0	0	0.0	0.0	0	0	0	0.0	0.0	0	0	0	0.0	0.0	0	0	0
Oct 1	1	12	97.0	5.1	71	129	8.8	1.7	2	22	13	116.2	3.2	93	134	13	13.1	1.1	5	20	25	69.4	1.7	53	85	25	3.6	0.2	2	6	
	2	0	0.0	0.0	0	0	0.0	0.0	0	0	0	0.0	0.0	0	0	0	0.0	0.0	0	0	25	129.4	1.8	112	144	25	28.0	1.4	17	40	
	3	0	0.0	0.0	0	0	0.0	0.0	0	0	0	0.0	0.0	0	0	0	0.0	0.0	0	0	8	163.4	3.2	151	173	8	61.5	3.6	48	75	
	4	1	328.0	0.0	328	328	253.0	0.0	253	253	0	0.0	0.0	0	0	0	0.0	0.0	0	0	0	0.0	0.0	0	0	0	0.0	0.0	0	0	0
Oct 15	1	25	87.5	3.4	65	122	7.9	0.9	3	18	9	127.4	3.7	111	145	9	19.3	2.2	11	32	25	76.0	1.9	58	95	25	5.6	0.4	2	9	
	2	0	0.0	0.0	0	0	0.0	0.0	0	0	0	0.0	0.0	0	0	0	0.0	0.0	0	0	25	128.7	2.8	110	150	25	29.2	2.0	15	45	
	3	1	189.0	0.0	189	189	64.0	0.0	64	64	3	159.3	3.4	155	166	3	34.7	3.7	31	42	25	169.9	2.6	154	200	25	67.1	2.7	45	91	
	4	0	0.0	0.0	0	0	0.0	0.0	0	0	0	0.0	0.0	0	0	0	0.0	0.0	0	0	0	0.0	0.0	0	0	0	0.0	0.0	0	0	0
Nov 1	1	25	89.0	4.2	63	141	7.8	1.3	2	31	13	136.0	2.7	120	151	13	24.5	1.8	13	35	25	65.9	1.7	52	83	25	3.0	0.3	2	7	
	2	0	0.0	0.0	0	0	0.0	0.0	0	0	0	0.0	0.0	0	0	0	0.0	0.0	0	0	15	127.5	2.5	115	145	15	25.9	1.6	19	38	
	3	1	191.0	0.0	191	191	71.0	0.0	71	71	0	0.0	0.0	0	0	0	0.0	0.0	0	0	4	161.0	7.1	151	182	4	49.8	5.1	36	59	
	4	0	0.0	0.0	0	0	0.0	0.0	0	0	0	0.0	0.0	0	0	0	0.0	0.0	0	0	0	0.0	0.0	0	0	0	0.0	0.0	0	0	0
Nov 15	1	6	103.2	7.2	81	123	12.7	2.7	5	20	22	149.7	1.6	131	163	22	30.6	1.0	21	38	25	75.9	1.9	59	96	25	5.9	0.4	2	11	
	2	0	0.0	0.0	0	0	0.0	0.0	0	0	0	0.0	0.0	0	0	0	0.0	0.0	0	0	25	127.4	2.3	106	150	25	28.8	1.7	17	49	
	3	2	159.0	0.0	159	159	43.0	0.0	43	43	1	180.0	0.0	180	180	1	64.0	0.0	64	64	11	168.5	4.3	151	191	11	70.6	6.5	48	108	
	4	0	0.0	0.0	0	0	0.0	0.0	0	0	0	0.0	0.0	0	0	0	0.0	0.0	0	0	0	0.0	0.0	0	0	0	0.0	0.0	0	0	0
Dec 1	1	18	105.4	4.2	85	142	12.6	1.7	3	29	25	145.5	2.8	118	162	25	28.7	1.8	13	48	25	76.1	1.3	65	95	25	5.6	0.3	4	10	
	2	0	0.0	0.0	0	0	0.0	0.0	0	0	0	0.0	0.0	0	0	0	0.0	0.0	0	0	12	126.7	2.5	111	142	12	27.1	1.7	16	38	
	3	2	162.5	1.5	161	164	45.5	0.5	45	46	4	171.5	2.5	166	178	4	50.0	1.5	47	54	0	0.0	0.0	0	0	0	0.0	0.0	0	0	0
	4	0	0.0	0.0	0	0	0.0	0.0	0	0	0	0.0	0.0	0	0	0	0.0	0.0	0	0	0	0.0	0.0	0	0	0	0.0	0.0	0	0	0
Dec 15	1	25	103.4	4.4	78	151	12.1	1.7	5	34	25	166.4	4.7	119	212	25	51.2	5.1	16	108	25	68.2	1.9	48	86	25	4.2	0.4	1	9	
	2	0	0.0	0.0	0	0	0.0	0.0	0	0	0	0.0	0.0	0	0	0	0.0	0.0	0	0	25	120.8	1.9	109							



APPENDIX B
WATER CHEMISTRY DATA



Table B-1

Water Chemistry Data Collected at Indian Point Unit 1 during 1975

Date	DO** (ppm)	Conductivity† (μ mho/cm)	Temperature (°C)
Jan 1	*	875.0	3.0
2	*	1007.0	4.0
3	*	777.0	2.0
4	*	425.0	2.5
5	*	314.0	2.5
6	*	286.0	2.8
7	*	556.0	2.8
8	*	284.0	3.0
9	*	650.0	4.0
10	*	1080.0	3.5
11	*	1380.0	4.0
12	*	1036.0	10.9
13	*	203.0	4.2
14	*	197.0	5.0
15	*	412.0	3.5
16	*	235.0	3.8
17	*	225.0	1.5
18	*	269.0	0.8
19	*	250.0	1.0
20	*	218.0	1.0
21	*	254.0	0.5
22	*	250.0	1.0
23	*	544.0	1.5
24	*	1519.0	2.0
25	*	2241.0	4.0
26	*	2108.0	3.0
27	*	385.0	3.0
28	*	422.0	4.0
29	*	354.0	4.9
30	*	273.0	4.0
31	*	234.0	2.6
Feb 1	*	207.0	2.0
2	*	230.0	1.3
3	*	211.0	1.5
4	*	227.0	1.2
5	*	238.0	0.2
6	*	256.0	0.3
7	*	1112.0	2.3
8	*	1187.0	0.3
9	*	1640.0	2.0
10	*	1579.0	1.5
11	*	2381.0	1.8
12	*	1566.0	2.0
13	*	1463.0	1.0
14	*	811.0	2.0
15	*	629.0	0.8
16	*	1070.0	1.0
17	*	723.0	4.0
18	*	585.0	2.1
19	*	455.0	2.8
20	*	729.0	1.1
21	*	803.0	3.0
22	*	3436.0	2.0
23	*	3534.0	2.2
24	*	2910.0	3.3
25	*	1515.0	2.8
26	*	260.0	3.3
27	*	273.0	3.0
28	*	240.0	3.6

* No data taken.

**DO corrected for the change in conductivity when it was converted to 25°C.

† Conductivity converted from conductivity at recorded temperature to conductivity at 25°C.



Table B-1 (Contd)

Date	DO** (ppm)	Conductivity† (μ mho/cm)	Temperature (°C)
Mar 1	*	244.0	1.7
2	*	259.0	1.0
3	*	209.0	1.4
4	*	201.0	3.0
5	*	218.0	3.5
6	*	203.0	4.0
7	*	201.0	4.0
8	*	214.0	4.0
9	*	277.0	0.0
10	*	810.0	2.4
11	*	1101.0	5.1
12	*	1204.0	4.5
13	*	1211.0	4.2
14	*	686.0	3.0
15	*	663.0	2.5
16	*	397.0	2.0
17	*	302.0	3.8
18	*	277.0	4.9
19	*	252.0	5.0
20	*	264.0	5.5
21	*	263.0	5.0
22	*	213.0	4.5
23	*	278.0	4.7
24	*	197.0	5.0
25	*	216.0	3.2
26	*	210.0	4.2
27	*	199.0	5.0
28	*	174.0	5.0
29	*	188.0	4.9
30	*	246.0	5.2
31	*	122.0	*
Apr 1	*	205.0	5.0
2	*	202.0	5.5
3	*	209.0	6.0
4	*	189.0	5.0
5	*	212.0	0.0
6	*	195.0	4.0
7	*	174.0	3.6
8	*	195.0	4.0
9	*	566.0	5.0
10	*	1215.0	5.0
11	*	1258.0	6.0
12	*	812.0	4.0
13	*	861.0	4.0
14	*	460.0	6.0
15	*	342.0	5.0
16	*	300.0	8.0
17	*	446.0	7.2
18	*	568.0	7.0
19	*	253.0	6.0
20	*	203.0	6.5
21	*	189.0	6.8
22	*	202.0	6.9
23	*	178.0	8.5
24	*	182.0	8.0
25	*	189.0	8.0
26	*	230.0	5.5
27	*	*	*
28	*	191.0	10.0
29	*	191.0	10.5
30	*	*	*

* No data taken.

**DO corrected for the change in conductivity when it was converted to 25°C.

† Conductivity converted from conductivity at recorded temperature to conductivity at 25°C.



Table B-1 (Contd)

Date	DO** (ppm)	Conductivity† (μ mho/cm)	Temperature (°C)
May 1	*	*	*
2	*	*	*
3	*	*	*
4	*	*	*
5	*	*	*
6	*	*	*
7	*	*	*
8	10.4	1008.0	14.0
9	9.4	847.0	14.5
10	9.0	320.0	13.3
11	10.0	340.0	14.0
12	9.6	307.0	14.2
13	9.0	234.0	15.0
14	10.0	160.0	15.0
15	10.5	148.0	15.0
16	11.0	137.0	14.5
17	11.2	138.0	15.0
18	11.0	134.0	15.5
19	9.4	139.0	16.0
20	8.4	136.0	16.0
21	10.6	140.0	16.8
22	*	*	*
23	*	*	*
24	*	*	*
25	*	*	*
26	*	*	*
27	*	*	*
28	*	*	*
29	*	*	*
30	*	*	*
31	9.8	153.0	20.5
Jun 1	9.8	146.0	21.0
2	10.5	144.0	20.0
3	*	*	*
4	*	758.0	21.0
5	*	*	*
6	*	*	*
7	*	*	*
8	9.1	265.0	22.0
9	6.3	2872.0	22.0
10	*	*	*
11	6.3	1788.0	21.8
12	7.5	2249.0	21.5
13	6.0	1272.0	22.0
14	7.7	465.0	21.0
15	6.9	321.0	21.5
16	6.8	213.0	21.8
17	7.2	159.0	22.0
18	6.8	182.0	23.0
19	*	*	*
20	7.0	182.0	23.0
21	6.9	178.0	24.0
22	8.0	173.0	24.0
23	6.4	178.0	24.0
24	6.0	175.0	25.0
25	7.5	184.0	25.0
26	7.2	188.0	24.0
27	*	*	*
28	*	*	*
29	*	*	*
30	*	*	*

* No data taken.

**DO corrected for the change in conductivity when it was converted to 25°C.

† Conductivity converted from conductivity at recorded temperature to conductivity at 25°C.



Table B-1 (Contd)

Date	DO** (ppm)	Conductivity† (μ mho/cm)	Temperature (°C)
Jul 1	*	*	*
2	9.3	2440.0	25.0
3	7.8	3287.0	25.0
4	7.6	2847.0	24.0
5	*	*	*
6	*	*	*
7	*	*	*
8	*	*	*
9	6.0	8588.0	26.0
10	5.1	7825.0	26.5
11	*	*	*
12	*	*	*
13	*	*	*
14	*	*	*
15	*	*	*
16	*	*	*
17	*	*	*
18	*	*	*
19	*	*	*
20	*	*	*
21	*	*	*
22	6.7	1052.0	27.0
23	6.7	800.0	26.0
24	6.8	744.0	26.5
25	7.4	676.0	26.5
26	5.3	299.0	27.2
27	5.4	272.0	26.5
28	7.3	276.0	27.5
29	7.3	227.0	26.5
30	7.4	222.0	26.5
31	7.5	220.0	27.0
Aug 1	7.9	467.0	27.2
2	7.8	1607.0	27.0
3	7.4	3443.0	27.0
4	7.2	3835.0	27.0
5	7.4	4929.0	26.0
6	7.4	6973.0	25.0
7	7.4	6311.0	27.0
8	*	5964.0	25.1
9	7.6	3452.0	25.2
10	8.7	2993.0	25.0
11	6.7	2995.0	26.5
12	5.6	2025.0	26.0
13	*	*	*
14	4.7	1083.0	26.0
15	5.7	2073.0	25.9
16	6.4	1127.0	25.8
17	5.8	2160.0	26.8
18	*	*	*
19	6.2	2008.0	27.0
20	5.5	2343.0	27.0
21	5.6	2687.0	27.0
22	5.9	2869.0	26.0
23	5.4	2017.0	25.0
24	5.7	2850.0	26.0
25	5.6	2928.0	26.0
26	6.1	3064.0	26.0
27	5.2	2440.0	26.0
28	5.9	2486.0	27.2
29	5.8	2620.0	28.6
30	5.9	2116.0	24.9
31	6.6	1930.0	24.8

* No data taken.

**DO corrected for the change in conductivity when it was converted to 25°C.

† Conductivity converted from conductivity at recorded temperature to conductivity at 25°C.



Table B-1 (Contd)

Date	DO** (ppm)	Conductivity† (μ mho/cm)	Temperature (°C)
Sep 1	6.6	1661.0	24.5
2	7.9	2135.0	24.0
3	7.3	1718.0	24.0
4	6.5	3069.0	24.5
5	6.8	3401.0	24.8
6	6.0	4018.0	24.1
7	6.6	2961.0	23.8
8	6.6	3605.0	24.2
9	7.2	2425.0	24.1
10	6.9	2044.0	24.0
11	7.1	2106.0	23.5
12	6.6	2376.0	25.5
13	6.5	1230.0	22.8
14	7.9	954.0	22.0
15	7.6	858.0	22.0
16	7.2	751.0	22.1
17	*	582.0	22.1
18	7.6	*	22.0
19	8.4	2135.0	21.9
20	7.5	1592.0	23.2
21	7.6	1653.0	22.0
22	8.5	765.0	21.9
23	7.3	768.0	21.0
24	7.8	857.0	21.5
25	8.0	643.0	21.5
26	7.6	350.0	20.5
27	8.0	221.0	20.0
28	8.0	226.0	19.0
29	8.3	233.0	18.7
30	8.3	275.0	19.0
Oct 1	8.8	*	19.0
2	8.4	240.0	18.5
3	8.6	242.0	18.0
4	*	219.0	18.8
5	8.7	219.0	18.0
6	8.2	223.0	18.5
7	8.2	219.0	18.0
8	8.0	225.0	18.0
9	8.1	*	18.5
10	8.5	224.0	17.0
11	8.0	222.0	17.5
12	9.2	219.0	18.0
13	8.4	258.0	17.2
14	8.8	258.0	17.2
15	9.0	211.0	17.2
16	9.2	208.0	17.1
17	9.3	223.0	16.0
18	9.6	235.0	16.0
19	9.6	217.0	16.0
20	9.0	217.0	16.0
21	*	*	*
22	*	*	*
23	9.6	251.0	14.0
24	9.4	189.0	14.0
25	9.8	202.0	14.0
26	9.9	189.0	14.0
27	9.9	189.0	14.0
28	8.4	197.0	13.7
29	7.4	207.0	12.9
30	7.8	206.0	13.0
31	12.6	198.0	12.0

* No data taken.

**DO corrected for the change in conductivity when it was converted to 25°C.

† Conductivity converted from conductivity at recorded temperature to conductivity at 25°C.



Table B-1 (Contd)

Date	DO** (ppm)	Conductivity† (µmho/cm)	Temperature (°C)
Nov 1	9.7	196.0	12.5
2	8.7	200.0	11.5
3	9.5	195.0	12.0
4	8.9	191.0	13.0
5	9.5	206.0	13.0
6	9.4	191.0	12.0
7	9.2	180.0	13.0
8	8.6	181.0	14.0
9	8.7	180.0	13.0
10	9.5	191.0	11.3
11	9.4	181.0	12.9
12	8.5	181.0	12.8
13	*	180.0	12.5
14	*	182.0	12.0
15	9.5	191.0	12.0
16	10.7	258.0	11.2
17	10.9	190.0	11.5
18	11.5	203.0	11.0
19	10.2	186.0	11.0
20	9.6	191.0	10.5
21	9.4	191.0	10.5
22	11.0	187.0	12.5
23	11.8	184.0	11.5
24	9.8	189.0	10.5
25	12.4	138.0	11.2
26	10.5	196.0	11.0
27	10.8	176.0	11.0
28	*	173.0	9.0
29	10.2	204.0	8.0
30	10.6	170.0	9.0
Dec 1	11.2	188.0	8.2
2	11.5	187.0	8.5
3	11.6	160.0	8.0
4	13.8	176.0	6.0
5	11.2	171.0	7.1
6	10.4	171.0	8.2
7	7.3	175.0	7.2
8	12.8	170.0	6.5
9	11.5	167.0	6.4
10	12.6	174.0	5.0
11	12.3	189.0	5.0
12	11.8	489.0	5.0
13	10.6	994.0	5.0
14	11.7	1373.0	5.0
15	12.5	1529.0	6.5
16	12.1	1877.0	6.8
17	12.3	2678.0	6.1
18	13.0	1228.0	6.0
19	12.1	599.0	4.0
20	12.4	728.0	4.5
21	12.3	877.0	4.0
22	12.8	828.0	4.0
23	*	*	*
24	*	*	*
25	12.6	211.0	1.5
26	12.1	219.0	2.8
27	*	225.0	1.9
28	13.2	185.0	1.3
29	14.2	186.0	1.2
30	12.6	171.0	2.9
31	14.2	178.0	1.1

* No data taken.

**DO corrected for the change in conductivity when it was converted to 25°C.

† Conductivity converted from conductivity at recorded temperature to conductivity at 25°C.



Table B-2

Water Chemistry Data Collected at Indian Point Unit 2 during 1975

Date	DO** (ppm)	Conductivity† (μ mho/cm)	Temperature (°C)
Jan 1	*	872.0	3.1
2	*	974.0	4.0
3	*	777.0	2.0
4	*	386.0	2.2
5	*	315.0	2.1
6	*	275.0	2.1
7	*	544.0	2.5
8	*	284.0	3.0
9	*	631.0	5.0
10	*	1136.0	4.5
11	*	1388.0	3.8
12	*	1043.0	9.8
13	*	195.0	4.0
14	*	201.0	3.0
15	*	412.0	3.5
16	*	245.0	2.0
17	*	209.0	1.8
18	*	266.0	0.6
19	*	237.0	1.3
20	*	207.0	0.0
21	*	245.0	0.5
22	*	234.0	1.0
23	*	491.0	1.5
24	*	1505.0	2.3
25	*	2260.0	4.2
26	*	1841.0	3.0
27	*	397.0	2.0
28	*	438.0	4.0
29	*	368.0	3.8
30	*	227.0	4.5
31	*	231.0	2.0
Feb 1	*	225.0	1.5
2	*	221.0	1.0
3	*	230.0	1.2
4	*	222.0	1.1
5	*	236.0	0.5
6	*	255.0	0.4
7	*	1088.0	3.0
8	*	1183.0	0.4
9	*	1625.0	2.3
10	*	1595.0	1.2
11	*	2573.0	2.0
12	*	1628.0	1.5
13	*	1475.0	2.2
14	*	820.0	2.0
15	*	772.0	0.1
16	*	1070.0	1.0
17	*	904.0	3.0
18	*	566.0	2.7
19	*	437.0	3.5
20	*	647.0	1.2
21	*	777.0	2.0
22	*	3280.0	2.0
23	*	3643.0	2.0
24	*	2736.0	2.7
25	*	1539.0	2.3
26	*	257.0	2.9
27	*	246.0	3.2
28	*	213.0	3.2

* No data taken.

**DO corrected for the change in conductivity when it was converted to 25°C.

† Conductivity converted from conductivity at recorded temperature to conductivity at 25°C.



Table B-2 (Contd)

Date	DO** (ppm)	Conductivity† (μ mho/cm)	Temperature (°C)
Mar 1	*	244.0	1.7
2	*	259.0	1.0
3	*	198.0	1.3
4	*	201.0	3.0
5	*	214.0	3.0
6	*	198.0	4.0
7	*	198.0	4.0
8	*	219.0	3.0
9	*	273.0	0.0
10	*	818.0	2.4
11	*	1101.0	5.1
12	*	1200.0	4.5
13	*	1200.0	4.5
14	*	595.0	2.5
15	*	646.0	2.5
16	*	388.0	2.0
17	*	299.0	3.8
18	*	276.0	5.0
19	*	252.0	5.0
20	*	257.0	5.5
21	*	257.0	5.0
22	*	213.0	4.5
23	*	271.0	4.7
24	*	190.0	4.8
25	*	210.0	3.2
26	*	211.0	4.0
27	*	200.0	4.0
28	*	174.0	5.0
29	*	188.0	4.9
30	*	248.0	5.0
31	*	122.0	*
Apr 1	*	205.0	5.0
2	*	213.0	5.0
3	*	197.0	7.0
4	*	195.0	4.0
5	*	216.0	0.0
6	*	195.0	4.0
7	*	174.0	3.6
8	*	195.0	4.0
9	*	511.0	6.0
10	*	1223.0	5.0
11	*	1228.0	6.0
12	*	779.0	4.0
13	*	844.0	4.0
14	*	417.0	5.8
15	*	379.0	5.0
16	*	351.0	7.0
17	*	418.0	7.0
18	*	553.0	7.0
19	*	253.0	6.0
20	*	194.0	7.0
21	*	185.0	7.0
22	*	202.0	6.9
23	*	180.0	7.5
24	*	182.0	8.0
25	*	188.0	8.3
26	*	230.0	5.5
27	*	251.0	7.2
28	*	194.0	10.0
29	*	201.0	10.0
30	*	195.0	9.2

* No data taken.

**DO corrected for the change in conductivity when it was converted to 25°C.

† Conductivity converted from conductivity at recorded temperature to conductivity at 25°C.



Table B-2 (Contd)

Date	DO** (ppm)	Conductivity† (µmho/cm)	Temperature (°C)
May 1	10.2	203.0	11.0
2	10.4	195.0	11.3
3	13.0	191.0	10.5
4	9.8	218.0	12.0
5	10.2	227.0	11.5
6	10.2	385.0	12.5
7	10.1	1361.0	14.0
8	10.2	895.0	14.0
9	9.5	781.0	14.0
10	10.2	322.0	13.0
11	10.0	328.0	14.0
12	9.6	302.0	14.0
13	9.8	234.0	15.0
14	9.9	164.0	14.0
15	10.5	148.0	15.0
16	10.8	137.0	14.5
17	11.0	140.0	15.0
18	11.2	136.0	15.0
19	9.4	139.0	16.0
20	8.6	137.0	16.5
21	11.2	140.0	17.0
22	9.4	158.0	19.0
23	9.2	147.0	17.0
24	9.0	150.0	18.0
25	10.2	127.0	18.0
26	10.0	130.0	21.0
27	*	144.0	20.0
28	9.2	135.0	19.0
29	9.0	128.0	19.7
30	9.2	155.0	20.0
31	10.0	147.0	21.0
Jun 1	9.5	141.0	21.0
2	10.0	144.0	20.0
3	*	141.0	20.8
4	*	754.0	21.2
5	12.6	206.0	21.0
6	9.3	346.0	21.0
7	9.1	334.0	21.2
8	9.0	265.0	22.0
9	7.5	2703.0	22.0
10	8.1	2495.0	21.3
11	7.2	1844.0	22.0
12	9.1	2543.0	21.0
13	7.5	1272.0	22.0
14	7.6	477.0	22.0
15	8.0	287.0	21.8
16	7.6	227.0	21.0
17	7.2	148.0	22.0
18	6.8	176.0	23.0
19	6.9	134.0	23.5
20	7.1	187.0	23.0
21	7.1	183.0	24.0
22	8.4	171.0	24.5
23	7.2	176.0	23.0
24	7.1	177.0	25.0
25	7.7	184.0	25.0
26	7.0	183.0	24.0
27	7.0	183.0	24.0
28	7.0	179.0	25.0
29	7.2	179.0	25.0
30	7.5	179.0	25.0

* No data taken.

**DO corrected for the change in conductivity when it was converted to 25°C.

† Conductivity converted from conductivity at recorded temperature to conductivity at 25°C.



Table B-2 (Contd)

Date	DO** (ppm)	Conductivity† (μ mho/cm)	Temperature (°C)
Jul 1	7.8	503.0	24.5
2	9.5	2440.0	25.0
3	7.9	3287.0	25.0
4	7.7	2829.0	24.3
5	6.9	6762.0	26.5
6	7.3	6503.0	27.0
7	7.3	7841.0	27.0
8	7.7	8049.0	25.0
9	4.9	7936.0	25.2
10	5.3	7746.0	27.0
11	7.6	7807.0	26.0
12	7.6	7746.0	27.0
13	7.3	7841.0	27.0
14	4.7	6475.0	25.0
15	6.9	3686.0	25.0
16	5.5	2761.0	25.5
17	7.5	2008.0	27.0
18	7.1	1591.0	26.0
19	7.3	1757.0	26.0
20	6.8	1691.0	26.5
21	7.4	1074.0	26.0
22	6.7	956.0	27.0
23	6.8	795.0	26.0
24	7.0	746.0	27.0
25	7.5	622.0	27.0
26	6.3	*	26.0
27	7.6	287.0	26.5
28	7.6	273.0	27.0
29	7.3	222.0	26.5
30	7.6	232.0	26.5
31	7.6	222.0	26.5
Aug 1	8.3	449.0	27.0
2	*	*	*
3	*	*	*
4	*	*	*
5	*	*	*
6	*	*	*
7	*	*	*
8	*	*	*
9	7.1	3006.0	25.2
10	*	2073.0	25.0
11	6.6	3074.0	26.0
12	6.2	2019.0	26.5
13	5.7	2635.0	26.0
14	4.8	1077.0	26.5
15	5.4	2489.0	26.0
16	6.8	1232.0	25.5
17	5.6	2131.0	26.6
18	6.7	1909.0	27.1
19	6.3	2008.0	27.0
20	5.4	2391.0	26.0
21	5.7	2645.0	26.0
22	7.6	2860.0	26.0
23	6.4	1987.0	26.0
24	5.9	2939.0	25.0
25	6.2	2947.0	26.0
26	6.2	2977.0	26.0
27	6.3	2372.0	27.0
28	6.4	2440.0	26.0
29	5.8	2790.0	25.5
30	5.8	2326.0	24.9
31	6.8	1996.0	24.9

* No data taken .

**DO corrected for the change in conductivity when it was converted to 25°C.

† Conductivity converted from conductivity at recorded temperature to conductivity at 25°C.



Table B-2 (Contd)

Date	DO** (ppm)	Conductivity† (µmho/cm)	Temperature (°C)
Sep 1	6.6	1661.0	24.5
2	7.9	2204.0	24.5
3	7.1	1627.0	24.0
4	6.5	2993.0	24.1
5	6.5	3595.0	24.2
6	6.6	4210.0	24.0
7	6.3	2866.0	24.2
8	6.3	4189.0	24.0
9	7.2	2516.0	24.1
10	6.1	2450.0	24.0
11	6.2	2620.0	23.5
12	6.3	2542.0	24.2
13	6.6	1282.0	22.8
14	7.2	1013.0	22.2
15	7.8	837.0	22.0
16	7.6	819.0	21.8
17	*	539.0	22.1
18	8.0	1906.0	21.5
19	8.5	2922.0	21.0
20	7.0	1618.0	21.8
21	7.8	1499.0	22.2
22	8.5	942.0	21.5
23	7.5	846.0	21.5
24	8.1	877.0	21.0
25	8.5	649.0	21.0
26	8.4	295.0	20.5
27	7.8	210.0	20.0
28	8.2	226.0	19.0
29	8.4	226.0	19.0
30	8.3	269.0	19.0
Oct 1	9.0	*	19.0
2	8.5	288.0	18.0
3	8.7	288.0	18.0
4	*	219.0	18.0
5	8.9	219.0	18.0
6	9.2	223.0	18.5
7	8.8	219.0	18.0
8	8.6	223.0	18.5
9	8.3	*	18.5
10	8.4	219.0	18.0
11	8.8	212.0	17.0
12	9.6	212.0	17.0
13	8.5	260.0	16.9
14	8.8	248.0	16.9
15	9.2	211.0	17.2
16	9.2	211.0	17.1
17	9.2	223.0	16.5
18	9.3	230.0	15.8
19	9.3	206.0	15.8
20	9.2	215.0	16.5
21	9.2	220.0	16.5
22	*	*	*
23	9.6	251.0	14.0
24	9.3	189.0	14.0
25	9.4	199.0	14.5
26	9.3	188.0	14.2
27	9.3	187.0	14.5
28	8.4	203.0	13.5
29	7.7	213.0	11.0
30	7.6	211.0	12.0
31	12.6	205.0	12.0

* No data taken.

**DO corrected for the change in conductivity when it was converted to 25°C.

† Conductivity converted from conductivity at recorded temperature to conductivity at 25°C.



Table B-2 (Contd)

Date	DO** (ppm)	Conductivity† (μmho/cm)	Temperature (°C)
Nov 1	9.9	198.0	12.0
2	9.4	183.0	12.5
3	9.4	197.0	11.9
4	9.0	191.0	13.5
5	9.6	215.0	12.5
6	9.4	189.0	12.5
7	9.8	181.0	13.5
8	9.2	173.0	13.5
9	8.2	180.0	12.5
10	*	*	*
11	9.2	180.0	13.0
12	8.2	208.0	12.6
13	*	196.0	12.5
14	*	182.0	12.0
15	9.4	197.0	12.3
16	10.8	254.0	11.5
17	11.0	192.0	11.0
18	11.0	214.0	11.5
19	10.6	189.0	11.0
20	9.3	190.0	10.9
21	9.4	193.0	11.0
22	11.8	185.0	12.0
23	12.2	183.0	10.5
24	10.0	194.0	10.0
25	12.0	140.0	11.1
26	11.5	189.0	11.0
27	11.5	183.0	10.8
28	*	*	*
29	10.6	178.0	8.0
30	10.7	172.0	8.5
Dec 1	11.4	172.0	9.3
2	11.2	177.0	9.0
3	11.3	167.0	8.0
4	13.2	172.0	7.9
5	11.4	171.0	7.2
6	10.6	167.0	8.0
7	11.3	168.0	6.2
8	12.2	173.0	6.8
9	11.6	167.0	6.4
10	12.6	173.0	5.1
11	11.5	189.0	5.0
12	13.0	498.0	5.5
13	14.6	1017.0	4.2
14	11.4	1253.0	7.5
15	11.5	1494.0	7.0
16	12.1	1964.0	6.0
17	12.3	2732.0	6.0
18	12.7	1381.0	6.0
19	10.8	471.0	4.0
20	12.6	536.0	4.0
21	12.4	680.0	4.5
22	13.0	682.0	4.0
23	14.0	469.0	3.0
24	13.5	418.0	3.0
25	12.5	202.0	2.8
26	*	225.0	3.2
27	*	235.0	1.5
28	12.7	183.0	2.6
29	14.2	187.0	1.1
30	*	*	*
31	14.2	176.0	2.0

* No data taken.

**DO corrected for the change in conductivity when it was converted to 25°C.

† Conductivity converted from conductivity at recorded temperature to conductivity at 25°C.



Table B-3

Water Chemistry Data Collected at Indian Point Effluent Canal during 1975

Date	DO** (ppm)	Conductivity† (μ mo/cm)	Temperature (°C)
Jan 1	*	770.0	3.0
2	*	980.0	3.8
3	*	767.0	1.0
4	*	450.0	3.1
5	*	270.0	14.1
6	*	288.0	3.5
7	*	539.0	2.8
8	*	237.0	19.0
9	*	508.0	18.0
10	*	768.0	19.0
11	*	867.0	21.5
12	*	918.0	18.8
13	*	170.0	14.0
14	*	163.0	17.5
15	*	240.0	18.5
16	*	200.0	15.0
17	*	181.0	12.9
18	*	193.0	15.0
19	*	215.0	12.5
20	*	185.0	12.0
21	*	189.0	14.0
22	*	228.0	10.0
23	*	524.0	8.0
24	*	1477.0	10.5
25	*	1979.0	12.0
26	*	1928.0	16.0
27	*	330.0	17.0
28	*	408.0	17.5
29	*	315.0	17.2
30	*	210.0	17.5
31	*	231.0	2.0
Feb 1	*	207.0	2.0
2	*	245.0	1.1
3	*	195.0	14.0
4	*	202.0	14.0
5	*	195.0	15.0
6	*	202.0	15.2
7	*	962.0	13.2
8	*	908.0	12.1
9	*	1272.0	12.7
10	*	1188.0	9.6
11	*	1998.0	13.0
12	*	1336.0	14.7
13	*	1238.0	13.9
14	*	722.0	13.0
15	*	565.0	9.2
16	*	762.0	14.4
17	*	580.0	16.5
18	*	516.0	16.2
19	*	403.0	14.7
20	*	646.0	15.5
21	*	627.0	16.0
22	*	2264.0	19.0
23	*	2376.0	18.0
24	*	2366.0	17.4
25	*	1430.0	16.5
26	*	205.0	17.4
27	*	198.0	16.9
28	*	183.0	15.5

* No data taken.

**DO corrected for the change in conductivity when it was converted to 25°C.

† Conductivity converted from conductivity at recorded temperature to conductivity at 25°C.



Table B-3 (Contd)

Date	DO** (ppm)	Conductivity† (µmho/cm)	Temperature (°C)
Mar 1	*	244.0	1.7
2	*	265.0	1.3
3	*	195.0	1.5
4	*	197.0	5.0
5	*	216.0	3.0
6	*	200.0	4.0
7	*	203.0	4.0
8	*	216.0	3.5
9	*	258.0	0.0
10	*	816.0	2.5
11	*	1137.0	4.0
12	*	1226.0	4.0
13	*	1211.0	4.2
14	*	650.0	4.0
15	*	659.0	2.7
16	*	519.0	3.0
17	*	310.0	3.8
18	*	275.0	5.1
19	*	258.0	5.1
20	*	260.0	5.5
21	*	267.0	5.0
22	*	206.0	4.8
23	*	284.0	5.0
24	*	187.0	4.2
25	*	208.0	3.4
26	*	222.0	3.9
27	*	207.0	4.2
28	*	174.0	5.0
29	*	174.0	5.0
30	*	248.0	5.0
31	*	125.0	*
Apr 1	*	213.0	5.0
2	*	205.0	5.0
3	*	199.0	7.0
4	*	199.0	5.5
5	*	200.0	3.2
6	*	170.0	7.5
7	*	184.0	3.0
8	*	176.0	14.0
9	*	444.0	17.0
10	*	1071.0	14.5
11	*	1012.0	16.0
12	*	670.0	13.0
13	*	630.0	14.0
14	*	428.0	14.0
15	*	338.0	13.0
16	*	258.0	13.0
17	*	391.0	18.8
18	*	427.0	18.0
19	*	198.0	19.0
20	*	175.0	18.0
21	*	171.0	18.0
22	*	166.0	16.7
23	*	168.0	16.8
24	*	153.0	17.0
25	*	166.0	20.0
26	*	184.0	16.6
27	*	195.0	17.7
28	*	179.0	20.0
29	*	192.0	19.0
30	*	186.0	19.0

* No data taken

**DO corrected for the change in conductivity when it was converted to 25°C.

† Conductivity converted from conductivity at recorded temperature to conductivity at 25°C



Table B-3 (Contd)

Date	DO** (ppm)	Conductivity† (µmho/cm)	Temperature (°C)
May 1	9.9	238.0	21.0
2	9.9	188.0	18.5
3	12.8	193.0	10.8
4	10.4	221.0	11.3
5	9.9	202.0	21.8
6	10.0	359.0	21.0
7	9.9	1166.0	22.0
8	9.6	964.0	21.5
9	9.0	779.0	21.0
10	10.0	338.0	20.7
11	10.5	325.0	21.0
12	9.4	279.0	22.3
13	9.2	214.0	24.0
14	9.2	148.0	22.0
15	10.2	136.0	22.5
16	11.8	139.0	25.0
17	10.5	121.0	24.5
18	10.8	122.0	23.0
19	9.0	137.0	23.2
20	6.4	138.0	25.5
21	10.2	142.0	27.5
22	9.0	143.0	27.0
23	8.9	127.0	26.0
24	8.5	133.0	27.5
25	*	116.0	26.5
26	8.5	119.0	29.0
27	15.5	129.0	29.0
28	7.4	124.0	27.0
29	8.5	116.0	28.5
30	8.0	138.0	32.0
31	8.8	139.0	30.0
Jun 1	9.5	129.0	28.7
2	9.5	148.0	20.5
3	*	149.0	28.4
4	*	1391.0	29.0
5	13.0	192.0	28.0
6	7.9	360.0	30.0
7	7.7	328.0	30.7
8	7.9	270.0	30.0
9	6.7	2892.0	29.0
10	6.6	2520.0	30.0
11	6.5	1798.0	29.8
12	7.7	2700.0	30.0
13	6.3	1305.0	31.0
14	7.0	454.0	30.5
15	7.7	324.0	30.0
16	6.9	225.0	30.0
17	6.9	176.0	31.0
18	6.8	173.0	32.0
19	6.0	159.0	31.0
20	6.5	176.0	31.0
21	6.7	185.0	31.0
22	6.5	173.0	32.0
23	6.7	171.0	32.0
24	6.8	168.0	34.0
25	6.0	176.0	31.2
26	6.5	174.0	34.0
27	6.8	183.0	34.0
28	6.8	183.0	34.0
29	7.0	174.0	34.2
30	7.6	186.0	33.0

* No data taken.

**DO corrected for the change in conductivity when it was converted to 25°C.

† Conductivity converted from conductivity at recorded temperature to conductivity at 25°C.



Table B-3 (Contd)

Date	DO** (ppm)	Conductivity† (µmho/cm)	Temperature (°C)
Jul 1	8.5	581.0	34.0
2	9.9	3403.0	34.0
3	6.9	3557.0	33.0
4	6.8	2766.0	32.0
5	6.1	6776.0	33.0
6	6.9	6226.0	34.0
7	6.8	8046.0	33.0
8	6.8	8301.0	34.0
9	6.8	8301.0	34.0
10	6.1	7969.0	34.0
11	6.9	6914.0	32.0
12	6.8	7623.0	33.0
13	6.8	7139.0	34.0
14	6.6	5413.0	31.5
15	8.5	3806.0	26.0
16	7.2	2706.0	31.5
17	7.8	2117.0	33.0
18	6.9	887.0	35.0
19	7.4	1691.0	35.5
20	7.6	1668.0	35.0
21	7.2	976.0	35.0
22	7.3	936.0	35.0
23	7.3	740.0	34.5
24	7.1	664.0	37.0
25	7.7	625.0	37.0
26	5.1	299.0	34.0
27	7.5	278.0	34.0
28	7.5	539.0	3.6
29	*	227.0	26.5
30	7.9	232.0	26.5
31	7.9	216.0	26.7
Aug 1	7.9	574.0	27.0
2	7.1	1758.0	27.3
3	6.1	3873.0	27.0
4	7.4	3921.0	27.0
5	7.5	5796.0	26.5
6	7.5	7023.0	25.0
7	7.5	6388.0	27.0
8	*	6916.0	25.4
9	7.7	3540.0	26.3
10	8.7	2891.0	28.0
11	7.6	2988.0	34.0
12	6.2	2608.0	26.5
13	6.1	2725.0	35.0
14	5.5	1130.0	26.5
15	5.9	2421.0	32.5
16	6.7	1154.0	34.0
17	6.1	2216.0	34.0
18	7.7	2024.0	33.0
19	5.8	2074.0	32.0
20	4.9	2324.0	34.0
21	5.6	2634.0	33.0
22	7.8	2879.0	26.0
23	5.8	1981.0	26.0
24	5.7	2930.0	32.0
25	5.7	3125.0	33.0
26	6.0	3320.0	34.0
27	6.4	2474.0	34.0
28	6.4	2429.0	34.4
29	6.0	2756.0	33.7
30	6.0	2328.0	32.3
31	6.8	2074.0	31.8

* No data taken.

**DO corrected for the change in conductivity when it was converted to 25°C.

† Conductivity converted from conductivity at recorded temperature to conductivity at 25°C.



Table B-3 (Contd)

Date	DO** (ppm)	Conductivity† (μ mho/cm)	Temperature (°C)
Sep 1	7.4	2064.0	31.2
2	*	*	*
3	7.8	1735.0	31.8
4	6.6	3028.0	31.8
5	6.6	3792.0	31.0
6	6.9	4283.0	30.0
7	6.4	2926.0	24.2
8	6.0	4220.0	30.0
9	7.2	2488.0	30.1
10	6.1	2421.0	30.0
11	6.0	2700.0	30.0
12	6.4	2512.0	30.5
13	7.9	1274.0	23.1
14	7.9	1013.0	22.2
15	*	802.0	31.0
16	7.7	820.0	30.5
17	*	556.0	31.0
18	8.1	2202.0	28.0
19	7.8	3039.0	29.0
20	7.8	1563.0	29.8
21	7.1	1571.0	31.5
22	8.6	800.0	30.6
23	7.3	624.0	30.5
24	7.8	900.0	30.0
25	8.2	648.0	30.0
26	8.2	264.0	30.0
27	8.2	220.0	29.0
28	8.0	226.0	19.0
29	8.4	234.0	28.0
30	8.2	223.0	28.0
Oct 1	8.9	*	28.0
2	8.5	285.0	29.0
3	8.8	293.0	26.0
4	*	220.0	26.0
5	8.8	227.0	25.5
6	8.1	220.0	26.0
7	8.2	224.0	26.0
8	8.1	222.0	26.5
9	8.0	*	26.5
10	8.2	239.0	24.0
11	8.3	226.0	19.0
12	9.4	224.0	26.0
13	8.5	264.0	26.0
14	8.6	277.0	27.0
15	9.0	210.0	27.0
16	9.7	208.0	18.0
17	9.5	218.0	17.0
18	9.4	232.0	16.5
19	9.9	215.0	16.5
20	9.0	203.0	16.5
21	9.0	226.0	16.5
22	*	*	*
23	10.4	248.0	14.8
24	10.4	187.0	14.5
25	11.1	197.0	15.0
26	10.5	199.0	11.8
27	10.5	196.0	12.5
28	7.8	194.0	13.5
29	7.7	203.0	13.1
30	7.9	200.0	13.0
31	12.6	202.0	19.0

* No data taken.

**DO corrected for the change in conductivity when it was converted to 25°C.

† Conductivity converted from conductivity at recorded temperature to conductivity at 25°C.



Table B-3 (Contd)

Date	DO** (ppm)	Conductivity† (µmho/cm)	Temperature (°C)
Nov 1	9.9	229.0	16.0
2	8.8	191.0	22.0
3	8.0	204.0	26.0
4	9.0	205.0	18.5
5	9.8	200.0	17.0
6	9.5	193.0	22.0
7	9.4	187.0	22.5
8	8.6	187.0	23.0
9	9.0	178.0	13.5
10	9.5	186.0	21.4
11	9.4	183.0	21.0
12	8.1	200.0	19.8
13	*	186.0	20.5
14	*	185.0	19.3
15	9.5	200.0	12.2
16	12.3	260.0	11.5
17	11.8	198.0	19.0
18	11.8	201.0	19.5
19	10.2	190.0	19.5
20	9.2	190.0	18.0
21	9.2	191.0	19.2
22	11.3	190.0	20.0
23	11.8	192.0	18.5
24	10.2	192.0	19.0
25	12.8	175.0	21.0
26	11.0	195.0	21.0
27	11.2	175.0	20.5
28	*	*	*
29	10.4	185.0	18.0
30	10.4	179.0	18.0
Dec 1	11.2	181.0	19.5
2	11.2	182.0	20.0
3	11.4	172.0	18.3
4	12.0	183.0	13.1
5	9.5	181.0	16.0
6	11.0	177.0	17.5
7	8.1	179.0	16.4
8	12.0	176.0	16.8
9	11.2	170.0	15.7
10	12.2	176.0	14.0
11	11.3	197.0	15.0
12	11.4	579.0	15.0
13	12.0	1111.0	4.8
14	11.9	1371.0	14.9
15	11.7	1663.0	16.0
16	11.9	1975.0	15.2
17	10.5	2716.0	14.9
18	11.5	1271.0	15.8
19	12.0	645.0	13.0
20	12.7	586.0	14.0
21	12.2	945.0	14.0
22	11.2	731.0	15.5
23	13.5	438.0	4.0
24	12.5	339.0	12.5
25	11.9	225.0	9.3
26	*	236.0	10.3
27	*	245.0	10.2
28	11.5	187.0	6.0
29	8.0	189.0	9.5
30	13.6	192.0	7.5
31	10.5	186.0	10.1

* No data taken.

**DO corrected for the change in conductivity when it was converted to 25°C.

† Conductivity converted from conductivity at recorded temperature to conductivity at 25°C.



APPENDIX C
PLANT VARIABLE DATA



Table C-1

Plant Variables Monitored at Indian Point Unit 1 during 1975

		No. of Circulators Operating**	Avg. Time Circulators Operating (hr)	Avg. Flow Rate per Screen (m ³ /min)	Avg. Head Loss (ft)	Avg. Time Air Curtain Operating (hr)	Total Flow for Unit (million m ³)
Jan	1	1	24.0	162.8	*	24.0	0.469
	2	1	23.5	162.8	*	23.5	0.459
	3	1	24.0	162.8	*	24.0	0.469
	4	1	24.0	162.8	*	24.0	0.469
	5	1	24.0	162.8	*	24.0	0.469
	6	1	24.0	162.8	*	24.0	0.469
	7	1	24.0	162.8	*	24.0	0.469
	8	1	23.5	162.8	*	23.5	0.459
	9	1	25.0	162.8	*	25.0	0.488
	10	1	24.0	162.8	*	24.0	0.469
	11	1	24.0	162.8	*	24.0	0.469
	12	1	24.0	162.8	*	24.0	0.469
	13	1	24.0	162.8	*	24.0	0.469
	14-15	1	*	*	*	*	*
	16	1	44.5	162.8	*	44.5	0.855
	17	1	20.0	162.8	*	20.0	0.391
	18	1	*	*	*	*	*
	19	0	*	*	*	*	*
	20	1	24.0	193.1	*	24.0	0.556
	21-22	1	*	*	*	*	*
	23	1	72.0	196.8	*	72.0	0.850
	24	1	59.0	196.8	*	59.0	1.394
	25	1	26.0	162.8	*	26.0	0.508
	26	1	23.0	162.8	*	23.0	0.449
	27	1	27.5	162.8	*	27.5	0.537
	28	1	21.5	162.8	*	21.5	0.420
	29	1	24.0	162.8	*	24.0	0.469
	30	1	26.5	162.8	*	26.5	0.518
	31	1	21.5	162.8	*	21.5	0.420
Feb	1	1	9.0	196.8	*	24.0	0.106
	2	1	24.0	196.8	*	24.0	0.283
	3	1	24.0	196.8	*	24.0	0.283
	4	1	51.3	193.1	*	51.3	1.200
	5	1	15.9	162.8	*	15.9	0.310
	6	1	24.0	162.8	*	24.0	0.469
	7	1	23.5	162.8	*	23.5	0.459
	8	1	24.5	162.8	*	24.5	0.479
	9	1	23.5	193.1	*	23.5	0.544
	10	1	24.5	193.1	*	24.5	0.568
	11	1	24.0	193.1	*	24.0	0.556
	12	1	23.5	193.1	*	23.5	0.544
	13	1	24.5	193.1	*	24.5	0.568
	14	1	24.0	193.1	*	24.0	0.556
	15	1	24.0	193.1	*	24.0	0.556
	16	1	24.0	193.1	*	24.0	0.556
	17	1	24.0	193.1	*	24.0	0.556
	18	1	24.0	193.1	*	24.0	0.556
	19	1	24.0	193.1	*	24.0	0.556
	20	1	24.0	193.1	*	24.0	0.556
	21	1	24.0	193.1	*	24.0	0.556
	22	1	24.0	193.1	*	24.0	0.556
	23	1	*	*	*	*	*
	24	1	48.0	193.1	*	48.0	1.112
	25	1	24.0	193.1	*	24.0	0.556
	26	1	24.0	193.1	*	24.0	0.556
	27	1	24.0	193.1	*	24.0	0.556
	28	1	24.0	193.1	*	24.0	0.556

*No data taken.

** Each circulator at Unit 1 serves 2 screens.



Table C-1 (Contd)

		No. of Circulators Operating **	Avg. Time Circulators Operating (hr)	Avg. Flow Rate per Screen (m ³ /min)	Avg. Head Loss (ft)	Avg. Time Air Curtain Operating (hr)	Total Flow for Unit (million m ³)
Mar	1	1	24.0	193.1	*	24.0	0.556
	2	1	24.0	193.1	*	24.0	0.556
	3	1	24.0	193.1	*	24.0	0.556
	4	1	24.0	196.8	*	24.0	0.567
	5	1	24.0	193.1	*	24.0	0.556
	6	1	24.0	193.1	*	24.0	0.556
	7	1	24.0	193.1	*	24.0	0.556
	8	1	24.0	196.8	*	24.0	0.567
	9	1	24.0	193.1	*	24.0	0.556
	10	1	24.0	193.1	*	24.0	0.556
	11	1	24.0	193.1	*	24.0	0.556
	12	1	24.0	193.1	*	24.0	0.556
	13	1	24.0	193.1	*	24.0	0.556
	14	1	24.0	193.1	*	24.0	0.556
	15	1	24.0	193.1	*	24.0	0.556
	16	1	24.0	193.1	*	24.0	0.556
	17	1	23.5	162.8	*	24.0	0.459
	18	1	24.0	162.8	*	24.0	0.469
	19	1	24.0	162.8	*	24.0	0.469
	20	1	24.0	162.8	*	24.0	0.469
	21	1	24.0	162.8	*	24.0	0.469
	22	1	24.0	162.8	*	24.0	0.469
	23	1	24.0	162.8	*	24.0	0.469
	24	1	24.0	162.8	*	24.0	0.469
	25	1	24.0	162.8	*	24.0	0.469
	26	1	24.0	162.8	*	24.0	0.469
	27	1	23.5	162.8	*	23.5	0.459
	28	1	24.5	162.8	*	24.5	0.479
	29	1	23.0	162.8	*	23.0	0.449
	30	1	23.5	162.8	*	23.5	0.459
	31	1	25.5	162.8	*	25.5	0.498
Apr	1	1	23.5	162.8	*	23.5	0.459
	2	1	24.0	162.8	*	24.0	0.469
	3	1	24.5	162.8	*	24.5	0.479
	4	1	24.0	162.8	*	24.0	0.469
	5	1	24.0	162.8	*	24.0	0.469
	6	1	23.5	162.8	*	23.5	0.459
	7	1	24.5	162.8	*	24.5	0.479
	8	1	24.0	162.8	*	24.0	0.469
	9	1	24.0	162.8	*	24.0	0.469
	10	1	27.5	162.8	*	27.5	0.537
	11	1	20.5	162.8	*	20.5	0.400
	12	1	23.5	162.8	*	23.5	0.459
	13	1	24.0	162.8	*	24.0	0.469
	14	1	24.5	162.8	*	24.5	0.479
	15	1	24.0	162.8	*	24.0	0.469
	16	1	24.0	166.6	*	24.0	0.480
	17	1	24.0	166.6	*	24.0	0.480
	18	1	24.0	166.6	*	24.0	0.480
	19	1	24.0	166.6	*	24.0	0.480
	20	1	24.0	166.6	*	24.0	0.480
	21	2	21.9	272.5	*	24.0	1.431
	22	2	24.0	272.5	*	24.0	1.570
	23	1	24.0	272.5	*	20.0	0.785
	24	1	24.0	272.5	*	*	0.785
	25	1	24.0	272.5	*	3.0	0.785
	26	1	24.0	272.5	*	24.0	0.785
	27-30	0	*	*	*	*	*



Table C-1 (Contd)

		No. of Circulators Operating**	Avg. Time Circulators Operating (hr)	Avg. Flow Rate per Screen (m ³ /min)	Avg. Head Loss (ft)	Avg. Time Air Curtain Operating (hr)	Total Flow for Unit (million m ³)
May	1-5	0	*	*	*	*	*
	6	1	*	*	*	*	*
	7	2	*	*	*	*	*
	8	1	26.0	272.5	*	26.0	0.850
	9	1	*	*	*	*	*
	10	1	47.5	272.5	*	47.5	1.554
	11	1	24.0	272.5	*	24.0	0.785
	12	1	29.0	272.5	*	29.0	0.948
	13	1	19.5	272.5	*	19.5	0.638
	14	1	24.0	272.5	*	24.0	0.785
	15	1	24.0	272.5	*	24.0	0.785
	16	1	24.0	272.5	*	24.0	0.785
	17	1	24.0	272.5	*	24.0	0.785
	18	1	24.0	272.5	*	24.0	0.785
	19	1	24.0	272.5	*	24.0	0.785
	20	1	24.0	272.5	*	24.0	0.785
	21-30	0	*	*	*	*	*
	31	1	21.8	272.5	*	21.8	0.711
Jun	1	1	*	*	*	*	*
	2	1	57.8	268.8	*	24.0	1.863
	3-6	0	*	*	*	*	*
	7	1	22.5	268.8	*	22.5	0.726
	8	1	24.0	268.8	*	24.0	0.774
	9	1	24.0	268.8	*	24.0	0.774
	10-11	0	*	*	*	*	*
	12	1	27.5	272.5	*	27.5	0.899
	13	1	*	*	*	*	*
	14	1	48.0	272.5	*	48.0	1.570
	15	1	24.0	272.5	*	24.0	0.785
	16	1	24.0	272.5	*	24.0	0.785
	17	1	24.0	272.5	*	24.0	0.785
	18-19	0	*	*	*	*	*
	20	1	17.5	268.8	*	*	0.564
	21	1	24.0	268.8	*	23.0	0.774
	22	1	24.0	268.8	*	24.0	0.774
	23	1	24.0	268.8	*	24.0	0.774
	24	1	24.0	268.8	*	24.0	0.774
	25	1	*	*	*	*	*
	26	1	48.5	268.8	*	48.5	1.564
	27-30	0	*	*	*	*	*
Jul	1	0	*	*	*	*	*
	2	1	9.5	268.8	*	9.5	0.306
	3-8	0	*	*	*	*	*
	9	1	9.0	299.0	*	*	0.323
	10	1	24.0	299.0	*	*	0.861
	11-22	0	*	*	*	*	*
	23	1	15.8	268.8	*	*	0.511
	24	0	*	*	*	*	*
	25	1	2.3	299.0	*	*	0.081
	26	1	24.0	299.0	*	*	0.861
	27	1	24.0	299.0	*	*	0.861
	28	1	24.0	299.0	*	*	0.861
	29	1	*	*	*	*	*
	30	1	30.5	299.0	*	*	1.095
	31	1	17.0	299.0	*	*	0.610



Table C-1 (Contd)

		No. of Circulators Operating**	Avg. Time Circulators Operating (hr)	Avg. Flow Rate per Screen (m ³ /min)	Avg. Head Loss (ft)	Avg. Time Air Curtain Operating (hr)	Total Flow for Unit (million m ³)
Aug	1	1	24.0	287.7	*	*	0.829
	2	1	*	*	*	*	*
	3	1	47.5	280.1	*	*	1.597
	4-5	1	*	*	*	*	*
	6	1	1.1	287.7	*	1.1	0.037
	7	1	24.5	287.7	*	24.0	0.846
	8	0	*	*	*	*	*
	9	1	6.2	287.7	*	*	0.215
	10-27	0	*	*	*	*	*
	28	1	7.5	268.8	*	0.0	0.242
	29	1	24.0	268.8	*	0.0	0.774
	30-31	0	*	*	*	*	*

Sep-Dec[†]

[†]During these months, Unit 1 did not operate.



Table C-2

Plant Variables Monitored at Indian Point Unit 2 during 1975

Date	No. of Circulators Operating	Avg. Time Circulators Operating (hr)	Avg. Flow Rate per Screen (m ³ /min)	Avg. Head Loss (ft)	Avg. Time Air Curtain Operating (ft)	Total Flow for Unit (million m ³)	
Jan	1	3	24.0	318.0	0.1667	24.0	1.374
	2	1	23.5	318.0	0.0	23.5	0.448
	3	1	24.0	318.0	0.0	24.0	0.458
	4	1	24.0	318.0	0.0	24.0	0.458
	5	3	24.0	318.0	0.0	23.0	0.458
	6	3	24.0	318.0	0.0667	24.0	1.374
	7	3	24.5	318.0	0.0	24.5	1.402
	8	3	24.0	318.0	0.0	24.0	1.374
	9	3	32.6	318.0	0.3200	32.6	1.867
	10	3	15.4	318.0	0.0	15.4	0.881
	11	3	33.0	318.0	0.3000	33.0	1.889
	12	4	19.7	318.0	0.1250	19.7	1.506
	13	4	23.5	318.0	0.0	24.0	1.793
	14	4	24.0	318.0	0.0	24.0	1.832
	15	4	26.0	318.0	0.0	26.0	1.984
	16	4	22.0	318.0	0.0	22.0	1.679
	17	4	15.0	318.0	0.0	15.0	1.145
	18	4	24.0	318.0	0.0	24.0	1.832
	19	4	24.0	318.0	0.0	24.0	1.832
	20	4	24.0	318.0	0.0	24.0	1.832
	21	4	24.0	318.0	0.0	24.0	1.832
	22	4	23.5	318.0	0.0	23.5	1.793
	23	4	24.0	318.0	0.0	24.0	1.832
	24	4	23.5	318.0	0.0500	23.5	1.793
	25	4	24.5	318.0	0.0	24.5	1.870
	26	4	36.0	318.0	0.0	36.0	2.747
	27	4	11.5	318.0	0.0	11.5	0.878
	28	4	24.5	318.0	0.1000	24.5	1.870
	29	4	32.0	318.0	0.0250	32.0	2.442
	30	4	25.0	318.0	0.7125	25.0	1.908
	31	4	22.5	318.0	0.0	22.5	1.717
Feb	1	1	13.0	318.0	0.1000	13.0	0.248
	2	1	17.3	318.0	0.2000	17.3	0.329
	3	4	14.0	318.0	0.1250	14.0	1.068
	4	4	24.0	318.0	0.1250	24.0	1.832
	5	4	24.0	318.0	0.1250	24.0	1.832
	6	4	24.0	318.0	0.0750	24.0	1.832
	7	4	24.0	318.0	0.0	24.0	1.832
	8	4	24.0	318.0	0.0250	24.0	1.832
	9	4	24.0	318.0	0.0	24.0	1.832
	10	4	24.0	318.0	0.1750	24.0	1.832
	11	4	24.0	318.0	0.1500	24.0	1.832
	12	4	24.0	318.0	0.3000	24.0	1.832
	13	4	35.0	318.0	0.1500	35.0	2.671
	14	4	13.0	318.0	0.0	13.0	0.992
	15	4	24.0	318.0	0.1750	24.0	1.832
	16	4	24.0	318.0	0.7000	24.0	1.832
	17	4	24.0	318.0	0.0	24.0	1.832
	18	4	24.0	318.0	0.3000	24.0	1.832
	19	4	24.0	318.0	0.2250	24.0	1.832
	20	4	24.0	318.0	0.1250	24.0	1.832
	21	4	24.0	318.0	0.0	24.0	1.832
	22	4	24.0	318.0	*	24.0	1.832
	23	4	24.0	318.0	0.0	24.0	1.832
	24	4	23.5	318.0	0.0	23.5	1.793
	25	4	34.5	318.0	0.8000	34.5	2.633
	26	4	20.5	318.0	0.5000	20.5	1.564
	27	4	17.5	318.0	0.4250	17.5	1.335
	28	4	24.0	318.0	0.0	24.0	1.832

*No data taken.



Table C-2 (Contd)

Date	No. of Circulators Operating	Avg. Time Circulators Operating (hr)	Avg. Flow Rate per Screen (m ³ /min)	Avg. Head Loss (ft)	Avg. Time Air Curtain Operating (hr)	Total Flow for Unit (million m ³)	
Mar	1	4	24.0	318.0	0.0750	24.0	1.832
	2	4	24.0	318.0	0.0	24.0	1.832
	3	4	24.0	318.0	0.0750	24.0	1.832
	4	4	24.0	318.0	0.6000	24.0	1.832
	5	2	24.0	318.0	0.0	24.0	0.916
	6	2	24.0	318.0	0.0	24.0	0.916
	7	2	24.0	318.0	0.0	24.0	0.916
	8	2	24.0	318.0	0.0500	24.0	0.916
	9	2	24.0	318.0	0.0	24.0	0.916
	10	2	18.8	318.0	0.0	18.8	0.715
	11	2	24.0	318.0	0.0	24.0	0.916
	12	1	24.0	318.0	0.1000	24.0	0.458
	13	1	11.7	318.0	0.0	11.7	0.223
	14	1	24.0	318.0	0.0	24.0	0.458
	15	1	24.0	318.0	0.4000	24.0	0.458
	16	1	24.0	318.0	0.6000	24.0	0.458
	17	1	24.0	318.0	0.3000	24.0	0.458
	18	1	24.0	318.0	0.3000	24.0	0.458
	19	2	16.6	318.0	0.0	20.0	0.634
	20	2	24.0	318.0	0.0	24.0	0.916
	21	2	24.0	318.0	0.2500	24.0	0.916
	22	2	24.0	318.0	0.1000	24.0	0.916
	23	2	24.0	318.0	0.1500	24.0	0.916
	24-25	2	*	*	*	*	*
	26	2	74.0	318.0	0.5500	74.0	2.824
	27	2	25.5	318.0	0.4000	25.5	0.973
	28	2	22.5	318.0	0.4000	22.5	0.859
	29	2	24.0	318.0	0.0	24.0	0.916
	30	2	24.0	318.0	0.0	24.0	0.916
	31	2	24.0	318.0	0.0	24.0	0.916
Apr	1	2	24.0	318.0	0.0	24.0	0.916
	2	2	24.0	318.0	0.0	24.0	0.916
	3	2	24.0	318.0	0.0	24.0	0.916
	4	2	24.0	318.0	0.0500	24.0	0.916
	5	4	24.0	371.0	0.1000	24.0	2.137
	6	4	24.0	371.0	0.1000	24.0	2.137
	7	4	24.0	371.0	0.0500	24.0	2.137
	8	4	24.0	371.0	0.1000	24.0	2.137
	9	3	24.0	459.3	0.0333	24.0	1.984
	10	4	23.3	477.0	0.0500	22.5	2.652
	11	4	24.0	477.0	0.0	24.0	2.747
	12	4	24.0	477.0	0.0250	24.0	2.747
	13	4	24.0	477.0	0.0750	24.0	2.747
	14	4	24.0	477.0	0.1000	24.0	2.747
	15	4	24.0	477.0	0.2750	24.0	2.747
	16	4	24.0	477.0	0.3500	24.0	2.747
	17	4	24.0	477.0	0.3250	24.0	2.747
	18	4	24.0	477.0	*	24.0	2.747
	19	5	24.3	530.0	0.3833	18.1	3.863
	20	5	24.0	530.0	0.4167	24.0	3.053
	21	4	24.0	530.0	0.2500	24.0	3.053
	22	4	24.0	530.0	0.0750	24.0	3.053
	23	5	38.0	530.0	0.5300	*	6.041
	24	5	19.4	530.0	1.2000	*	3.084
	25	5	11.0	530.0	0.8444	11.0	1.399
	26	4	2.5	530.0	0.0	2.5	0.318
	27	6	10.5	530.0	0.3600	10.5	1.669
	28	5	32.7	530.0	0.3727	32.5	5.199
	29	5	15.2	530.0	0.6750	15.2	2.417
	30	5	26.2	530.0	0.7875	26.2	4.165

*No data taken.



Table C-2 (Contd)

Date	No. of Circulators Operating	Avg. Time Circulators Operating (hr)	Avg. Flow Rate per Screen (m ³ /min)	Avg. Head Loss (ft)	Avg. Time Air Curtain Operating (hr)	Total Flow for Unit (million m ³)	
May	1	5	19.6	530.0	0.7800	19.6	3.116
	2	5	13.8	530.0	0.3667	13.8	2.194
	3	1	24.0	530.0	0.0	24.0	0.763
	4	5	10.2	530.0	0.4000	10.2	1.616
	5	5	21.8	530.0	0.0	21.8	3.466
	6	5	24.0	530.0	0.0	24.0	3.816
	7	4	24.0	530.0	0.0	24.0	3.053
	8	5	22.7	530.0	0.6667	22.7	3.609
	9	5	22.2	530.0	0.1000	22.2	3.530
	10	5	24.0	530.0	0.0	24.0	3.816
	11	5	26.6	530.0	0.3667	26.6	4.229
	12	5	22.2	530.0	0.5333	22.2	3.530
	13	5	25.6	530.0	0.5167	25.6	4.070
	14	5	24.2	530.0	1.1143	11.0	3.847
	15	5	26.9	530.0	0.4300	26.9	4.277
	16	5	18.5	530.0	0.6400	18.5	2.941
	17	5	24.0	530.0	0.6667	24.0	3.816
	18	5	24.0	530.0	0.0200	24.0	3.816
	19	5	24.0	530.0	0.5400	24.0	3.816
	20	5	24.0	530.0	0.5400	24.0	3.816
	21	5	24.0	530.0	0.0	24.0	3.816
	22	5	24.0	530.0	0.0	24.0	3.816
	23	5	24.0	530.0	0.0200	24.0	3.816
	24	5	24.0	530.0	0.0	24.0	3.816
	25	5	24.0	530.0	0.0400	24.0	3.816
	26	5	25.9	530.0	0.4571	25.9	4.118
	27	5	22.1	530.0	0.1200	22.1	3.514
	28-29	5	*	*	*	*	*
	30	5	21.5	530.0	0.2000	21.5	3.418
	31	6	23.8	530.0	0.3000	23.8	4.532
Jun	1	6	24.0	530.0	0.4000	24.0	4.579
	2	6	17.4	530.0	0.6000	17.4	3.328
	3	6	24.0	530.0	0.0667	*	4.579
	4	6	24.0	530.0	0.1667	*	4.579
	5	6	24.0	530.0	0.3000	23.0	4.579
	6	6	23.3	530.0	0.2333	23.3	4.444
	7	6	24.0	530.0	0.1833	24.0	4.579
	8	6	24.0	530.0	0.2000	24.0	4.579
	9	6	24.0	530.0	0.1000	24.0	4.579
	10	6	25.3	530.0	0.4143	25.3	4.833
	11	6	23.7	530.0	*	23.7	4.515
	12	6	24.0	530.0	0.1833	24.0	4.579
	13	6	23.0	530.0	0.0167	23.0	4.388
	14	5	24.0	530.0	0.1400	24.0	3.816
	15	6	22.3	530.0	0.2000	22.3	4.261
	16	6	24.0	530.0	0.0500	24.0	4.579
	17	6	24.0	530.0	0.0333	24.0	4.579
	18	6	24.0	530.0	0.0	24.0	4.579
	19	6	24.0	530.0	0.0333	24.0	4.579
	20	6	24.8	530.0	0.1429	*	4.738
	21	6	22.5	530.0	0.0	23.2	4.293
	22	6	24.0	530.0	0.1500	24.0	4.579
	23	6	24.0	530.0	0.2167	24.0	4.579
	24	6	24.0	530.0	0.2333	24.0	4.579
	25	6	24.0	530.0	0.1000	24.0	4.579
	26	6	24.0	530.0	0.2714	24.0	4.579
	27	6	24.0	530.0	0.0	24.0	4.579
	28	6	24.0	530.0	0.1667	24.0	4.579
	29	6	25.0	530.0	0.0500	28.0	4.770
	30	6	23.9	530.0	0.0500	23.9	4.563

*No data taken.



Table C-2 (Contd)

Date	No. of Circulators Operating	Avg. Time Circulators Operating (hr)	Avg. Flow Rate per Screen (m ³ /min)	Avg. Head Loss (ft)	Avg. Time Air Curtain Operating (hr)	Total Flow for Unit (million m ³)
Jul 1	6	24.0	530.0	0.1000	24.0	4.579
2	6	24.0	530.0	0.0571	24.0	4.579
3	6	22.2	530.0	0.0	5.5	4.240
4	5	22.9	530.0	0.0	22.9	3.641
5	5	24.0	530.0	0.0	*	3.816
6	5	24.0	530.0	0.0	*	3.816
7	6	21.8	530.0	0.2333	*	4.165
8	6	24.0	530.0	0.0	*	4.579
9	6	24.0	530.0	0.1500	*	4.579
10	6	24.9	530.0	0.0	*	4.754
11	6	23.1	530.0	0.1667	*	4.404
12	6	25.5	530.0	0.2429	*	4.857
13	6	21.7	530.0	0.4000	*	4.142
14	6	24.0	530.0	0.4500	24.0	4.579
15	6	24.9	530.0	*	24.9	4.754
16	6	24.0	530.0	0.1667	23.1	4.579
17	6	24.0	530.0	*	*	4.579
18	6	24.0	530.0	*	24.0	4.579
19	6	23.1	530.0	*	23.1	4.404
20	6	25.3	530.0	0.0857	25.3	4.817
21	6	23.0	530.0	0.0333	23.0	4.380
22	6	24.1	530.0	0.1857	24.1	4.595
23	6	24.0	530.0	*	24.0	4.579
24	6	23.1	530.0	0.0333	23.1	4.404
25	6	24.0	530.0	*	24.0	4.579
26	6	24.9	530.0	*	24.9	4.754
27	6	24.0	530.0	*	24.0	4.579
28	6	23.1	530.0	*	23.1	4.404
29	2	24.0	530.0	0.7500	*	1.526
30-31	0	*	*	*	*	*
Aug 1-10	0	*	*	*	*	*
11	6	19.4	530.0	*	19.4	3.711
12	6	*	*	*	*	*
13	6	40.9	530.0	0.3077	40.4	7.801
14	6	22.2	530.0	0.1167	*	4.229
15	6	22.5	530.0	0.0667	22.5	4.301
16	6	22.2	530.0	0.1667	22.2	4.229
17	6	29.5	530.0	0.1167	29.5	5.628
18	6	23.5	530.0	0.5667	23.5	4.483
19	6	6.0	530.0	0.0667	6.0	0.572
20	6	24.0	530.0	0.0222	24.0	4.579
21	6	24.0	530.0	0.0778	24.0	4.579
22	6	24.0	530.0	*	24.0	4.579
23	4	17.6	441.6	0.0	17.6	2.238
24	6	14.1	530.0	0.0	14.1	2.695
25	6	14.1	530.0	0.0	14.1	2.695
26	6	25.0	530.0	0.0889	25.0	4.770
26	6	24.0	530.0	0.0222	24.0	4.579
27	6	21.7	530.0	0.3714	21.7	4.142
28	6	26.0	530.0	0.1778	26.0	4.968
29	6	21.0	530.0	0.0167	21.0	4.006
30	6	26.2	530.0	0.0500	26.2	5.003
31	6	23.5	530.0	0.0667	23.5	4.481

*No data taken.



Table C-2 (Contd)

Date	No. of Circulators Operating	Avg. Time Circulators Operating (hr)	Avg. Flow Rate per Screen (m ³ /min)	Avg. Head Loss (ft)	Avg. Time Air Curtain Operating (hr)	Total Flow for Unit (million m ³)
Sep 1	6	23.8	530.0	0.1333	23.8	4.531
2	6	21.5	530.0	0.0	21.5	4.102
3	6	24.5	530.0	0.8833	24.5	4.674
4	6	21.4	530.0	0.1000	21.4	4.086
5	6	26.1	530.0	*	0.0	4.976
6	6	21.0	530.0	*	0.0	4.006
7	6	24.9	530.0	0.2286	0.0	4.754
8	5	24.0	530.0	0.6000	24.0	3.816
9	6	20.9	530.0	*	20.9	3.988
10	6	24.0	530.0	0.2833	24.0	4.579
11	6	27.0	530.0	2.4000	0.0	5.151
12	6	20.4	530.0	0.0200	0.0	3.897
13	1	30.0	530.0	0.1000	0.0	0.954
14	1	18.0	530.0	*	0.0	0.572
15	5	27.8	530.0	0.0	0.0	4.421
16	6	21.5	530.0	*	0.0	4.107
17	6	24.0	530.0	*	0.0	4.579
18	6	24.0	530.0	*	24.0	4.579
19	5	29.5	530.0	0.4400	29.5	4.690
20	5	19.5	530.0	0.1000	19.5	3.100
21	5	24.3	530.0	0.0800	24.3	3.855
22	5	22.8	530.0	*	22.8	3.617
23	5	24.8	530.0	*	21.5	3.935
24	5	23.3	530.0	*	22.5	3.696
25	5	24.0	530.0	*	24.0	3.816
26	5	30.0	530.0	*	30.0	4.770
27	5	19.5	530.0	0.1667	19.5	3.100
28	3	27.3	530.0	0.1000	27.3	2.607
29	5	14.9	530.0	*	0.0	2.374
30	5	24.0	530.0	*	24.0	3.816
Oct 1	5	25.2	530.0	*	25.2	4.006
2	5	28.6	530.0	*	28.6	4.552
3	5	19.2	530.0	*	0.0	3.047
4	5	25.4	530.0	1.2800	0.0	4.038
5	5	27.1	530.0	0.6000	5.5	4.309
6	5	19.6	530.0	1.2000	19.6	3.116
7	5	24.1	530.0	*	24.1	3.832
8	5	22.8	530.0	*	22.8	3.625
9	5	25.3	530.0	0.8200	25.3	4.022
10	5	27.3	530.0	0.8000	27.3	4.340
11	5	19.6	530.0	0.6400	19.6	3.124
12	5	23.8	530.0	*	23.8	3.776
13	5	24.0	530.0	*	24.0	3.816
14	5	19.5	530.0	1.0400	19.5	3.100
15	5	28.5	530.0	0.2600	28.5	4.531
16	5	24.0	530.0	0.9400	24.0	3.816
17	1	24.0	530.0	*	24.0	0.763
18	1	24.0	530.0	*	24.0	0.763
19	1	12.7	530.0	4.8000	12.7	0.403
20	1	2.8	530.0	0.4000	2.8	0.088
21	1	24.0	530.0	*	24.0	0.763
22	1	*	*	*	*	*
23	1	16.5	530.0	*	24.0	0.525
24	1	24.0	530.0	*	24.0	0.763
25	1	24.0	530.0	0.1000	24.0	0.763
26	1	29.3	530.0	3.5500	0.0	0.930
27	1	17.4	530.0	*	0.0	0.554
28	1	24.0	530.0	*	0.0	0.763
29	1	22.4	530.0	*	0.0	0.711
30	1	11.3	530.0	*	0.0	0.358
31	5	17.7	530.0	2.0000	17.7	2.813

*No data taken.



Table C-2 (Contd)

Date	No. of Circulators Operating	Avg. Time Circulators Operating (hr)	Avg. Flow Rate per Screen (m ³ /min)	Avg. Head Loss (ft)	Avg. Time Air Curtain Operating (hr)	Total Flow for Unit (million m ³)	
Nov	1	5	27.6	530.0	1.7300	27.6	4.388
	2	5	24.0	530.0	1.1286	24.0	3.816
	3	5	26.9	530.0	*	26.9	4.277
	4	3	10.3	530.0	*	10.3	0.986
	5	2	24.0	530.0	*	24.0	1.526
	6	4	*	*	*	*	*
	7	5	40.2	530.0	*	16.7	6.390
	8	5	24.0	530.0	0.4800	24.0	3.816
	9	5	24.0	530.0	0.5400	24.0	3.816
	10	5	24.0	530.0	0.5400	24.0	3.816
	11	5	24.0	530.0	0.5400	24.0	3.816
	12	5	24.0	530.0	0.5200	24.0	3.816
	13	5	26.6	530.0	0.6143	26.6	4.229
	14	5	21.4	530.0	1.2000	21.4	3.402
	15	1	24.5	530.0	1.0000	0.0	0.779
	16	5	*	*	*	*	*
	17	5	19.0	530.0	*	*	3.026
	18	5	24.0	530.0	*	24.0	3.816
	19	5	24.0	530.0	*	24.0	3.816
	20	5	24.3	530.0	0.9000	27.4	3.858
	21	5	26.3	530.0	1.8000	26.3	3.349
	22	5	27.3	530.0	4.2143	28.1	4.346
	23	5	18.5	530.0	0.5273	18.5	2.941
	24	5	22.6	530.0	*	22.6	3.593
	25	5	24.0	530.0	*	24.0	3.816
	26	5	24.0	530.0	1.2800	24.0	3.816
	27	5	24.0	530.0	0.3600	24.0	3.816
	28	5	24.0	530.0	0.3000	24.0	3.816
	29	5	24.0	530.0	0.4200	24.0	3.816
	30	5	38.3	530.0	1.1900	38.3	6.081
Dec	1	5	19.5	530.0	2.6000	19.5	3.100
	2	5	22.3	530.0	*	22.3	3.537
	3	5	24.1	530.0	2.2000	24.1	3.840
	4	5	14.8	530.0	0.1200	14.8	2.353
	5	5	30.2	530.0	0.7200	30.2	4.801
	6	5	17.1	530.0	0.8500	17.1	2.719
	7	5	24.0	530.0	1.6167	24.0	3.816
	8	5	22.9	530.0	*	22.9	3.641
	9	5	24.0	530.0	0.7800	24.0	3.816
	10	6	24.0	530.0	0.3600	24.0	3.816
	11	5	24.0	530.0	0.2800	24.0	3.816
	12	5	24.0	530.0	0.2600	24.0	3.816
	13	5	24.0	530.0	0.1200	24.0	3.816
	14	5	24.0	530.0	0.2600	24.0	3.816
	15	6	23.9	494.6	0.4000	24.0	4.263
	16	6	24.0	494.6	0.3000	24.0	4.274
	17	6	24.0	494.6	*	24.0	4.274
	18	6	25.1	494.6	0.2167	25.1	3.685
	19	6	22.0	424.0	0.2500	22.0	3.367
	20	5	25.0	424.0	0.7500	25.0	3.059
	21	5	24.1	424.0	0.4000	24.1	2.916
	22	5	22.6	388.6	0.2400	22.6	2.537
	23	5	24.1	318.0	*	24.1	2.301
	24	6	23.8	318.0	*	23.8	2.721
	25	6	*	*	*	*	*
	26	6	24.0	318.0	0.2333	24.0	2.747
	27	6	24.0	318.0	0.1000	24.0	2.747
	28	6	24.0	318.0	0.1167	24.0	2.747
	29	6	24.0	318.0	*	24.0	2.747
	30	6	24.0	318.0	*	24.0	2.747
	31	6	24.0	318.0	*	24.0	2.747

*No data taken.



APPENDIX D

QUALITY-ASSURANCE CHECK ON TOTAL-COUNT
ESTIMATE PROCEDURE



APPENDIX D

QUALITY-ASSURANCE CHECK ON TOTAL-COUNT ESTIMATE PROCEDURE

A. INTRODUCTION

White perch, Atlantic tomcod, and striped bass have been designated as key species for impact studies in the Hudson River estuary. White perch and Atlantic tomcod compose approximately 80% of the annual impingement at Indian Point, while striped bass are of importance from a commercial and sport viewpoint. These three species are the subject of ongoing population studies, which include a mark/recapture program for young-of-the-year, yearlings, and adults. Consequently, all impinged specimens of these three species were counted and examined for marks and tags.

For all other species, total counts since 1 January 1975 have been estimated by subsampling and number/weight relationships (Section III. A). This appendix describes the quality-assurance procedures and results used to evaluate the reliability of this technique.

B. METHODS

To estimate the total number of each species impinged, 100 specimens of that species collected during a given screen wash were randomly selected; this assured that rare species and small collections would be counted, not estimated. The total number collected was estimated from the total weight of that species in the collection.



During 1975, the subsampling technique for impingement estimation was used for seven species; for only three of those species was the estimation procedure used in more than 2 months (Table D-1). Quality-assurance checks were conducted for two of the three most frequently estimated species: these checks were conducted on small (638 blueback herring), medium (1397 bay anchovy), and large (2487 blueback herring) collections to evaluate the effect of sample size on the variance of estimates from actual counts. For each collection, 10 consecutive random subsamples of 100 fish were weighed and returned to the collection. The percent absolute error of the total number estimate was calculated for each subsample:

$$\% \text{ absolute error} = \left| \frac{\hat{N} - N}{N} \right|$$

where N was the actual count of the entire species collection and \hat{N} was the estimated count. When the weights of the 10 subsamples for the two larger collections were combined, the estimation accuracy of a large subsample, 1000 fish, could also be evaluated.

Table D-1

Number of Days per Month when Sample Size Estimation Procedure Was Used for Any Species in Impingement Collections at Indian Point during 1975

Species	Number of Days											
	J	F	M	A	M	J	J	A	S	O	N	D
Bay anchovy						4	28	21	24	15		
Bluefish						1	1					
Hogchoker					8	1	2	7	14			
Blueback herring							1	2	1	21	29	7
Rainbow smelt					5							
White catfish											23	1
Weakfish								12	9			



C. RESULTS

The results of the QA checks on the estimate of total number in the three collections indicated that 100-fish subsampling was quite adequate for accurately and precisely estimating the size of the collection. The maximum percent absolute error for any of the 30 subsamples was < 6%, and more than 90% of the subsamples had < 5% absolute error in their estimates of the total collection (Tables D-2, D-3, and D-4). Of course, taking a subsample of 1000 fish would provide a more accurate estimate, as might be expected from the formula for percent absolute difference (Table D-5), but the increased accuracy is not warranted for estimating impingement from collections of varying efficiency (Section II).

Table D-2

Results of Subsampling Tests from October 1975
Collection of 638 Blueback Herring with Total Weight of 1248 g

Subsample Size	Subsample Weight	Estimate of Sample Size	% Absolute Difference from N
100	194.5	642	0.63
100	187.9	658	3.13
100	200.0	624	2.19
100	203.0	615	3.61
100	208.0	600	5.96
100	184.9	675	5.80
100	199.8	625	2.04
100	195.0	640	0.31
100	186.7	668	4.70
100	200.6	622	3.09
Mean		637	3.09



Table D-3

Results of Subsampling Tests from June 1975
Collection of 1397 Bay Anchovy with Total Weight of 2836.4 g

Subsample Size	Weight	Estimate of Sample Size	% Absolute Difference from N
100	208.6	1360	2.65
100	201.3	1409	0.86
100	195.0	1455	4.15
100	207.1	1370	1.93
100	211.0	1344	3.79
100	200.8	1413	1.15
100	199.8	1420	1.65
100	204.4	1388	0.64
100	209.3	1355	3.01
100	193.6	1465	4.87
Mean		1398	2.47

Table D-4

Results of Subsampling Tests from October 24, 1975,
Collection of 2487 Blueback Herring with Total Weight of 4925 g

Subsample Size	Weight	Estimate of Sample Size	% Absolute Difference from N
100	191.0	2597	3.70
100	190.3	2588	4.06
100	193.3	2548	2.45
100	208.1	2367	4.83
100	200.0	2463	0.97
100	197.3	2496	0.36
100	199.0	2475	0.48
100	204.0	2414	2.94
100	200.0	2463	0.97
100	203.7	2418	2.87
Mean		2481	2.36



Table D-5

Results of Subsampling (Using 1000-Fish Subsample)
from Collections of 1397 and 2487 Fish

Species	N	\hat{N}
Bay anchovies	1397	1397*
Blueback herring	2487	2479*

* Obtained by adding the 10 subsamples of size 100 in
Tables D-2 and D-3.

