



# **IAEA Safeguards Workshop**

**Jane Marshall, Chief  
Material Control and Accounting Branch  
Fuel Facility Licensing Directorate  
Office of Nuclear Materials Safety and Safeguards  
U.S. Nuclear Regulatory Commission**

**August 2007**

Enclosure 11

# Tentative Agenda

## **Tuesday, August 28, Morning**

Welcome and Introduction – J. Marshall

- 1 – IAEA Safeguards Background – T. Grice
- 2 – US-IAEA Safeguards Agreement and Initial Protocol – B. Moran
- 3 – U.S. Eligible Facilities List and IAEA Selection – B. Moran
- 4 – Additional Protocol – T. Grice

## **Tuesday, August 28, Afternoon**

- 5 – 10 CFR Part 75 – T. Grice
- 6 – Design Information Questionnaire – B. Moran
- 7 – Model Schedule for IAEA Safeguards – B. Moran

## **Wednesday, August 29, Morning**

- 8 - Safeguards Inspection Overview – B. Horn
- 9 - HEU Downblending Plant Safeguards Overview – B. Moran
- 10 - HEU Downblending Facility Lessons Learned – B. Horn
- 11 - Enrichment Plant Safeguards Overview – B. Moran

## **Wednesday, August 29, Afternoon**

- 12 - Discussion – B. Moran
- Closing – J. Marshall

# Workshop Objectives

- Describe the role of international nuclear safeguards within the nonproliferation regime and its importance
- Communicate the requirements placed on the U. S. and its licensees
- Provide information on the Additional Protocol
- Present an overview of IAEA safeguards and implementation process
- Allow opportunity for questions and discussions



# **Session 1: IAEA Safeguards Background**

**Thomas A. Grice  
U.S. Nuclear Regulatory Commission**

**August 2007**

# History of the IAEA

- Inception
  - "**Atoms for Peace**" speech delivered by President Eisenhower to the UN General Assembly in New York City on December 8, 1953
- IAEA Statute
  - Established as an autonomous organization of the U.N. on July 29, 1957
- Non-Proliferation Treaty (NPT) 1970
  - Understood as presenting *three pillars*: *non-proliferation, disarmament, and the right to peacefully use nuclear technology*

# ATOMS FOR PEACE

- Background:
  - Secrecy fails as USSR and UK test A-bomb in 1949, 1952;
  - U.S. and USSR test H-bomb in 1952, 1953
  - Disarmament negotiations deadlocked
- Shift in emphasis from disarmament to peaceful cooperation in exchange for peaceful use commitment
- Proposed establishing international organization to promote peaceful uses of nuclear energy
  - Source of nuclear materials and technical information
  - Assistance subject to verification of peaceful use
- U.S. Atomic Energy Act of 1954 codified U.S. bilateral program of cooperation and aid to countries interested in nuclear energy
  - Research reactors and other facilities placed under bilateral agreements for cooperation and bilateral safeguards arrangements

# CREATION OF THE IAEA

- IAEA Statute (treaty) approved 23 October 1956 after 1954-56 Geneva Conferences
- Statute entered into force July 29, 1957
  - 11 years after UNAEC
  - 11 years before NPT
- IAEA objectives
  - Enlarge contribution of nuclear energy to peace, health and prosperity throughout the world
  - Ensure technology is not used to further any military purpose

# IAEA ORGANIZATION

The IAEA was established by Statute in 1957 and is an autonomous agency of the United Nations

- 130 IAEA member states
- Director General & Secretariat
- 35 Board of Governors
  - 10 most advanced technology nations
  - 25 member states representing geographical regions

IAEA staff ~2200 people  
~550 in safeguards

IAEA regular budget is \$225M with \$82M for safeguards

U.S. provides \$52.25M dues plus an extra budgetary contribution of \$47M



**IAEA Headquarters**  
**Vienna, Austria**



# Non-Proliferation Treaty (NPT)

- U.S. and Russian text included two basic elements:
  - Prohibit non-nuclear-weapon states from manufacturing or otherwise acquiring nuclear weapons
  - Prohibit nuclear-weapon states from distributing nuclear weapons to non-nuclear-weapon states

# Non-Proliferation Treaty (NPT)

## Non-Nuclear Weapon States Emphasized Several Additional Themes

- Disarmament (Article VI)
  - Good faith negotiations for end nuclear arms race, nuclear disarmament, general and complete disarmament
- Access to Nuclear Technology (Article IV)
  - Peaceful nuclear activities and cooperation
- Security assurances (preamble)

# Non-Proliferation Treaty (NPT)

- Entered into force March 5, 1970
- 188 Parties
- Global in scope
- Extended indefinitely by decision of states parties, May 11, 1995
- Eighth Review Conference takes place in 2010

# Non-Proliferation Treaty (NPT)

- The NPT is a landmark international treaty whose objectives are to
  - Prevent the spread of nuclear weapons and weapons technology
  - Foster the peaceful uses of nuclear energy
  - Further the goal of achieving general and complete disarmament
- All NPT parties required to bring into force a comprehensive safeguards agreement with the IAEA
- The NPT requires **safeguards** on all source and special fissionable material in a non-nuclear weapons state (NNWS)

# IAEA STATUTES

- **IAEA Authority**

- The Statute provides the **legal authority** for the IAEA to establish and implement safeguards to ensure the peaceful use of nuclear energy.
- The Statute gives the IAEA authority to enter into **safeguards agreements** with States to verify that nuclear material is not diverted from peaceful purposes to nuclear explosives or purposes unknown
- Non-Proliferation Treaty requires NNWS to bring into force a comprehensive safeguards agreement with the IAEA
- Safeguards Agreements establish safeguards requirements on State

- **IAEA Limitations**

- The IAEA does not assert control over nuclear materials or nuclear activities in a State
- IAEA safeguards are implemented by cooperation to accomplish specific goals
- The IAEA has no enforcement authority

# International Safeguards Evolution

Information circulars (INFCIRCs) are the legal instruments that establish IAEA safeguards objectives and practices

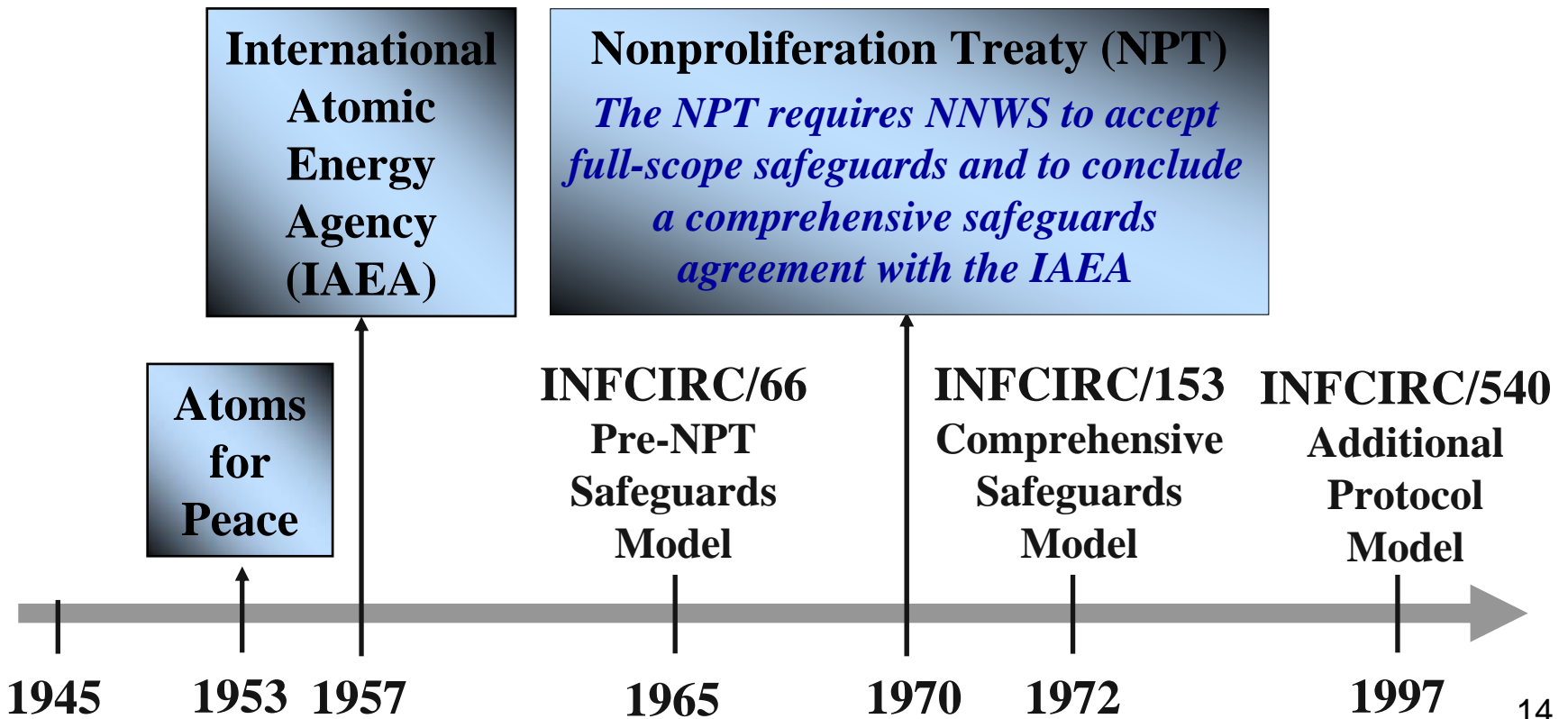

# Requirements of Safeguards Agreements (INFCIRC/153)

- **Safeguards Objective**
  - **28** “The Agreement should provide that the objective of safeguards is the **timely detection of diversion of significant quantities of nuclear material** from peaceful nuclear activities...”
- **Methods to Accomplish Objective**
  - **29** “...the Agreement should provide for the use of material accountancy as a safeguards measure of fundamental importance, with containment and surveillance as important complementary measures.”
- **Technical Conclusion**
  - **30** “The Agreement should provide a technical conclusion of the Agency’s verification activities ... of the **amount of material unaccounted for (MUF) over a specific period**, giving the limits of accuracy of the amounts stated.”

## **Comprehensive Safeguards Model (INFCIRC/153)**

- Safeguards focus is verification of declared materials in declared facilities
- Safeguards on all source and special fissionable material in a State allow the IAEA to provide credible assurance of the nondiversion of nuclear material from declared activities
- Safeguards is based on **design verification and materials accountancy**, augmented by **containment and surveillance**
- Provision is provided for special inspections by the Agency, in principle at any location, but the provision is rarely used

**Verify  
State's  
Declarations**

**Nuclear  
Materials  
Accounting**

**C/S  
and  
Monitoring**

**Independent  
Inspections  
and Conclusion**



# Safeguards Agreements and Arrangements

## Safeguards Agreement

*Defines safeguards requirements for a State  
Submitted to the Board of Governors for approval*

## Subsidiary Arrangement

*Specifies details of safeguards implementation*

Facility Attachment *M*



Facility Attachment *N*

*A facility attachment defines safeguards  
measures for a specific facility*

# Safeguards Significant Quantities

- Significant Quantity (SQ)**

- The approximate quantity of nuclear material ... taking into account any conversion process ... the possibility of manufacturing a nuclear explosive cannot be excluded

MATERIAL	SIGNIFICANT QUANTITY	CALCULATED TERMS
<b>Direct Use Nuclear Material</b>		
Pu <sup>a</sup>	8 kg	Total Element
<sup>233</sup> U	8 kg	Total Isotope
U ( <sup>235</sup> U > 20%)	25 kg	<sup>235</sup> U
<b>Indirect Use Nuclear Material</b>		
U ( <sup>235</sup> U < 20%) <sup>b</sup>	75 kg	<sup>235</sup> U
Th	20 t	Total Element

<sup>A</sup> For Pu containing less than 80% <sup>238</sup>Pu

<sup>B</sup> Including natural and depleted uranium

# Safeguards Timeliness

- **Timeliness Detection Goal**
  - Detect diversion of a significant quantity of:
    - Unirradiated HEU, U-233, or Pu
      - 1 month
    - Irradiated HEU, U-233, or Pu
      - 3 months
    - Depleted, natural, or low-enriched uranium (LEU), or thorium
      - 12 months

# Design of the Safeguards Approach

- **significant quantity and timely detection** must be “translated” into detection goals to allow safeguards approaches to be applied in an effective manner.
- Safeguards criteria were developed by the IAEA for each type of nuclear facility consisting of a system of nuclear material accountancy, containment, surveillance, and other measures to meet detection goals\*.
- The criteria are adapted to specific facilities, detailed inspection goals, procedures, and measures are specified in subsidiary arrangements and facility attachments.

\* Detection goals serve as guidelines for development of safeguards approaches and detailed procedures for inspection activities.

# Types and Numbers of Nuclear Facilities Under IAEA Safeguards

<b>Item Facilities</b> <i>(nuclear material exists as identifiable items)</i>	
	<b>No.</b>
Power reactors	236
Research reactors and critical assemblies	169
Separate storage facilities	70
Other facilities ( $>1 \text{ kg}_{\text{eff}}$ nuclear material)	82
Non-nuclear installations	1

<b>Bulk Handling Facilities</b> <i>(nuclear material exists in loose form)</i>	
	<b>No.</b>
Conversion plants	13
Fuel fabrication plants	46
Reprocessing plants	6
Enrichment plants	14
Other locations ( $<1 \text{ kg}_{\text{eff}}$ nuclear material)	448

## IAEA Safeguards Applied to Facilities and Materials

- Over 600 facilities in 71 countries are under IAEA safeguards
- The IAEA inspects and maintains material accountancy for:
  - 686 metric tonnes of plutonium (Pu),
  - 21 metric tonnes of highly enriched uranium (HEU), and
  - 42,200 metric tonnes of low-enriched uranium (LEU)

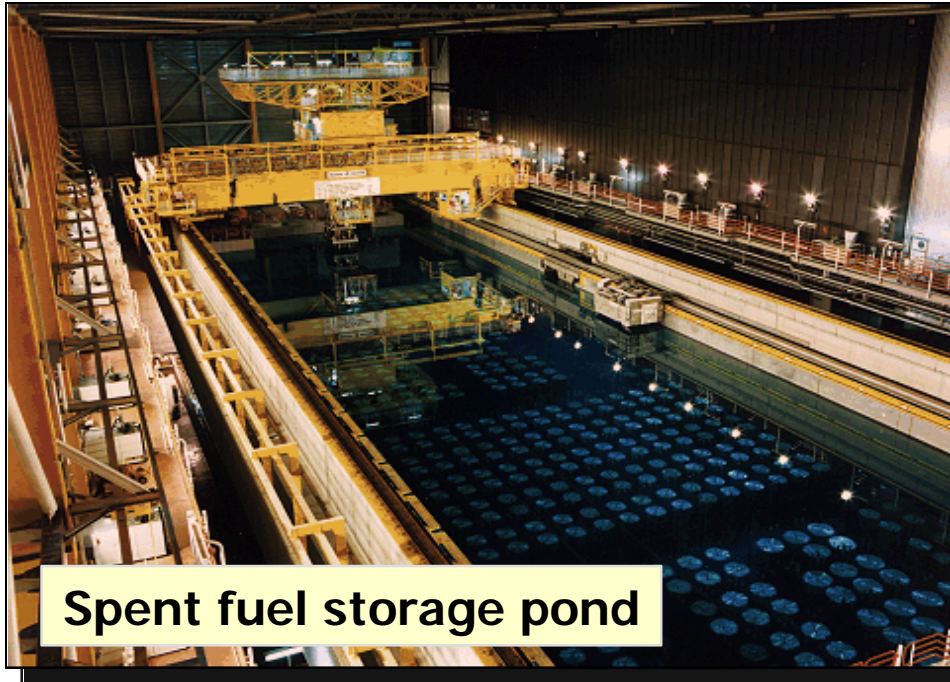

**Spent fuel storage pond**

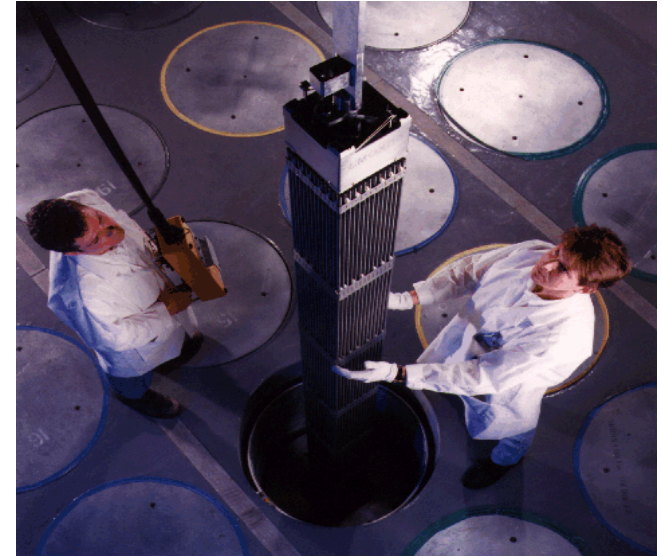

**Fuel assembly**

# Placing a Facility and Nuclear Materials Under IAEA Safeguards

- State submits a Design Information Questionnaire (DIQ) that is used by the IAEA to develop a safeguards approach
- IAEA conducts design information verification (DIV) inspections of declared facility
- State provides a declaration of its initial nuclear material inventory
- IAEA completes an initial nuclear material inventory verification

# IAEA Develops Safeguards Approach

- Using the DIQ and the Safeguards Criteria, the IAEA and the State negotiate a safeguard approach for a specific facility, which includes:
  - Inspection frequency
  - Design information verification
  - Records and reports
  - Nuclear material verification measures (nondestructive and destructive measurements)
  - Containment/surveillance measures



# Facility Attachments

- The IAEA and the State negotiate a Facility Attachment which contains details of how IAEA Safeguards will be implemented at each facility
- The Facility Attachment must be updated whenever the facility design changes
- IAEA conducts routine safeguards inspections
  - Periodic design information verification (DIV)
  - Annual physical inventory verification (PIV)
  - Periodic interim inventory verification (IIV)

# Verify Initial Inventory Declaration

- The Initial Inventory Verification includes:
  - IAEA verification of the declared items
  - Measurement by destructive assay (DA) and nondestructive assay (NDA) of statistical sample of nuclear material to verify the quantity of nuclear material, type, form, and composition
- Ad hoc and routine inspections are then conducted, according to the safeguards agreement, to verify non-diversion of significant quantities of nuclear material.
- Containment and surveillance use optical surveillance systems, tamper seals and containment verification devices to provide continuity-of-knowledge (C-o-K) on nuclear materials at the facility.

# Destructive Assay (DA) of Samples to Verify Nuclear Materials



The IAEA routinely takes samples at key measurement points to verify declared materials and operations. The samples are analyzed by the IAEA's Safeguards Analytical Laboratory (SAL) in Seibersdorf, Austria.

## Uranium Laboratory

Treatment and analysis of all samples not containing any plutonium or fission products

## Plutonium Laboratory

Treatment and analysis of all samples containing plutonium but no fission products

## Spent Fuel Laboratory

Treatment of all samples containing fission products

# Nondestructive Assay (NDA) of Samples to Verify Nuclear Materials



**PORTABLE INSTRUMENTATION FOR IAEA USING MICRO-PROCESSOR TECHNOLOGY**

- MULTI-CHANNEL ANALYZER FOR U ENRICHMENT, Pu ISOTOPICS, AND OTHER APPLICATIONS
- HIGH LEVEL NEUTRON COINCIDENCE COUNTER FOR  $^{239}\text{Pu}$  EFFECTIVE
- ACTIVE WELL COUNTER FOR CANS OF  $\text{UO}_2$ , PELLETS AND SCRAP

# Containment/Surveillance (C/S)

- Meet safeguards objective of timely detection and deterrence of diversion of SQ of NM.
- Reduce efforts required to carry out NMA verification.
- Reduce radiation exposure to inspectors.
- Reduce cost of safeguards implementation.
- Provide continuity-of-knowledge on nuclear materials in difficult-to-access areas.
- Provide assurance on non-misuse of facilities for undeclared material and activity.
- Provide diversion detection capability for some strategies not covered by NMA verification.

# Containment/Surveillance (C/S)

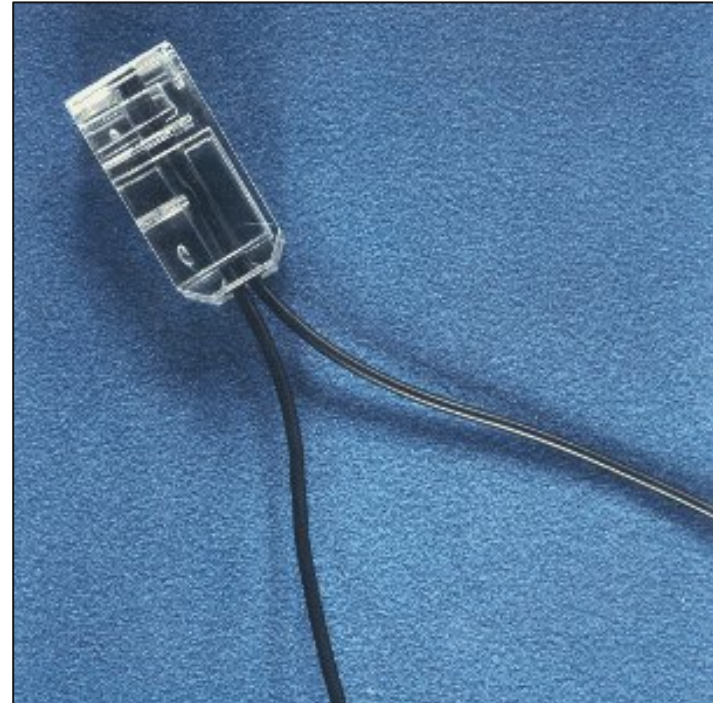

*C/S is used to maintain continuity of knowledge and reduces the need to remeasure nuclear material*



# Nuclear Materials Accountancy

- Accountancy of nuclear materials by the facility and declared by the State is verified by the IAEA
  - Facility operator accounting
  - State system of accounting and control (**SSAC**) of nuclear material
  - IAEA verification

# Facility Operator Accounting and Reporting Requirements

- Facility operator maintains for each **material balance area (MBA)**:
  - Nuclear material accounting records
    - Inventory changes
    - Inventory measurement results
    - Adjustments and corrections
    - Batch and source data
  - Operating records
    - Nuclear material amounts and composition
    - Calibration, sampling, and analysis
    - Measurement control and error estimates
    - Physical inventories
    - Nuclear material loss analyses
    - Nuclear material movement events



# State Material Accountancy

- State System of Accounting and Control (SSAC)
  - Formats and submits facility operator accounting reports to the IAEA
  - Ensures that accounting procedures and arrangements are correctly adhered to by the facility
  - Provides for IAEA access and facilitates inspection to enable inspectors to carry out verification activities and protect operator interests
  - Submits design information questionnaire and other facility communications to IAEA

# IAEA Materials Accountancy

- The IAEA inspects facilities and independently verifies the State's declared nuclear material quantities and locations
  - Auditing accounting and operating records
  - Verifying facility inventory and inventory changes
  - Maintaining independent nuclear material book inventory
  - Removing, inspecting, and attaching seals
  - Collecting and reviewing surveillance data
  - Requesting samples and performing measurements by DA and NDA
  - Verifying operation and calibration of measurement systems
  - Investigating causes of Material Unaccounted For (MUF)\*, shipper/receiver differences, and uncertainties in the book inventory
  - Other activities as provided for in the safeguards agreement

*\*MUF – Material Unaccounted For or Inventory Difference, is the difference between operator measured physical inventory and the operator book inventory.*

# IAEA Accountancy Summary

- Purpose of independent IAEA verification
  - Detection of falsified accounting data
  - Confirmation of operator measurement accuracies and uncertainties
- Verification process
  - Setup sampling strata from nuclear material inventory
  - Random sampling from strata for independent NDA and DA verification measurements
  - Calculate Facility – IAEA material balance difference
- Materials balance evaluation
  - Estimate combined measurement uncertainties in MUF
  - Determine the allowable MUF due to measurement uncertainty
  - Calculate  $(MUF - D)^*$  and compare with uncertainty estimates

*\*MUF - D is the difference between operator measurements and IAEA material balance determination.*

# Measurement Criteria for Defects

## Verification of Uranium

<b>Defect Type</b>	<b>Defect Description</b>	<b>Measurements Required</b>	<b>Measurement Method</b>
Gross	U missing or replaced	Radiation	Low-resolution gamma Spectroscopy
Partial	Part of U missing	Mass Enrichment and weight	Active neutron coincidence counting High-resolution gamma spectrometry plus weighing
Bias	U or U-235 content bias	U and U-235 content	Destructive Analysis

# Measurement Criteria for Defects

## Verification of Plutonium

<b>Defect Type</b>	<b>Defect Description</b>	<b>Measurements Required</b>	<b>Measurement Method</b>
Gross	No Pu	Pu Radiation	Passive neutron coincidence counting or High-resolution gamma spectrometry plus weighing
Partial	Part of Pu Missing	Pu content	Passive neutron coincidence counting or High-resolution gamma spectrometry plus weighing
Bias	Pu content bias	Pu content	Destructive Analysis

# NDA Instruments Used to Verify Nuclear Material in Storage Facilities

Measurement	Method	Instrument (Acronym)
U, Pu Radiation	Low-resolution gamma spectrometry	<u>Portable MCA</u> – <u>NaI</u> (PMCN)
<sup>235</sup> U Mass	Active neutron coincidence counting	<u>Active Well Coincidence Counter</u> (AWCC)
<sup>235</sup> U Enrichment	Low-resolution gamma spectrometry	<u>Portable MCA</u> – <u>NaI</u> (PMCN)
	High-resolution gamma spectrometry	<u>Portable MCA</u> – <u>HPGe</u> (PMCG)
<sup>240</sup> Pu-Effective Mass	Passive neutron coincidence counting	<u>High-Level Neutron Coincidence Counter</u> (HLNC)
<sup>240</sup> Pu-Effective Fraction	High-resolution gamma spectrometry	<u>Portable MCA</u> – <u>HPGe</u> (PMCG)

# Summary Objectives of Safeguards

- **Political Objectives**

- Provide assurance that States are meeting their nonproliferation obligations
- Deter diversion of materials and misuse of facilities
- Deter development of nuclear weapons programs

- **Technical Objectives**

- Ensure the completeness of declared inventories
- Provide timely detection of diversion of significant quantities of nuclear material from peaceful nuclear activities
- Deter such diversion by risk of early detection



# **Session 2: US-IAEA Safeguards Agreement and Protocol**

Bruce W. Moran  
U.S. Nuclear Regulatory Commission



# U.S.-IAEA Commitments

- U.S. Voluntary Offer – 1967
- Nuclear Non-Proliferation Treaty – 1970
- Export and Import Notifications for Nuclear Material – 1974
- U.S.-IAEA Safeguards Agreement – 1980
- Protocol to the Agreement – 1980
- Subsidiary Arrangements – 1980
- Nuclear Cooperation Agreements – Various
- Additional Protocol – pending

# U.S.-IAEA Safeguards

- The IAEA Inspectorate verifies compliance with safeguards commitments under the U.S.-IAEA Safeguards Agreement.
- U.S. provides technical support and training to strengthen implementation of IAEA safeguards
- It is in the U.S. national security interest to have a well trained and effective IAEA Inspectorate

# IAEA Inspections in the U.S.

- Safeguards Objectives
  - Meet legal obligations from safeguards agreements
  - Enhance efficiency of IAEA safeguards by verifying nuclear material before export
  - Gain experience in implementing new safeguards approaches or technologies
    - Demonstration of nonproliferation principles
    - Proof of principle for technology use in a nuclear facility
    - Test of practicality for implementation of safeguards measures
    - Enhancement of safeguards measures and procedures



# **U.S. Participants in IAEA Safeguards**

- Department of State
- Department of Energy
  - National Laboratories
- Nuclear Regulatory Commission
- Operators of facilities under IAEA Safeguards
- Department of Defense
- Department of Commerce

# U.S.-IAEA Communications

- Formal
  - Documents
    - Design Information Questionnaires
    - Facility Attachments
    - Inventory Change Reports, Material Balance Reports, Physical Inventory Listings
  - Letters
    - Inspection notifications, Inspection reports
- Informal
  - E-Mails (logistics, updates)
  - Telephone conversations

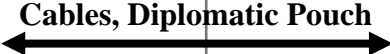
# Formal U.S. Government – IAEA Communications

Agency	IAEA	U.S. Mission to International Organizations (IAEA Section)	State Department (Bureau of Int'l Security and Nonproliferation)	NRC
Typical Contacts	<ul style="list-style-type: none"> <li>• Director General</li> <li>• Deputy Director General</li> <li>• Division Director</li> <li>• Section Head</li> <li>• Unit Head</li> <li>• Site Officer</li> </ul>	<ul style="list-style-type: none"> <li>• U.S. Mission</li> </ul>	<ul style="list-style-type: none"> <li>• Office of Multilateral Nuclear and Security Affairs</li> </ul>	<ul style="list-style-type: none"> <li>• NMSS/FCSS/FFLD/MCAB</li> </ul>
Means of Communication				
				

# Inter-USG Communication Concerning IAEA Safeguards

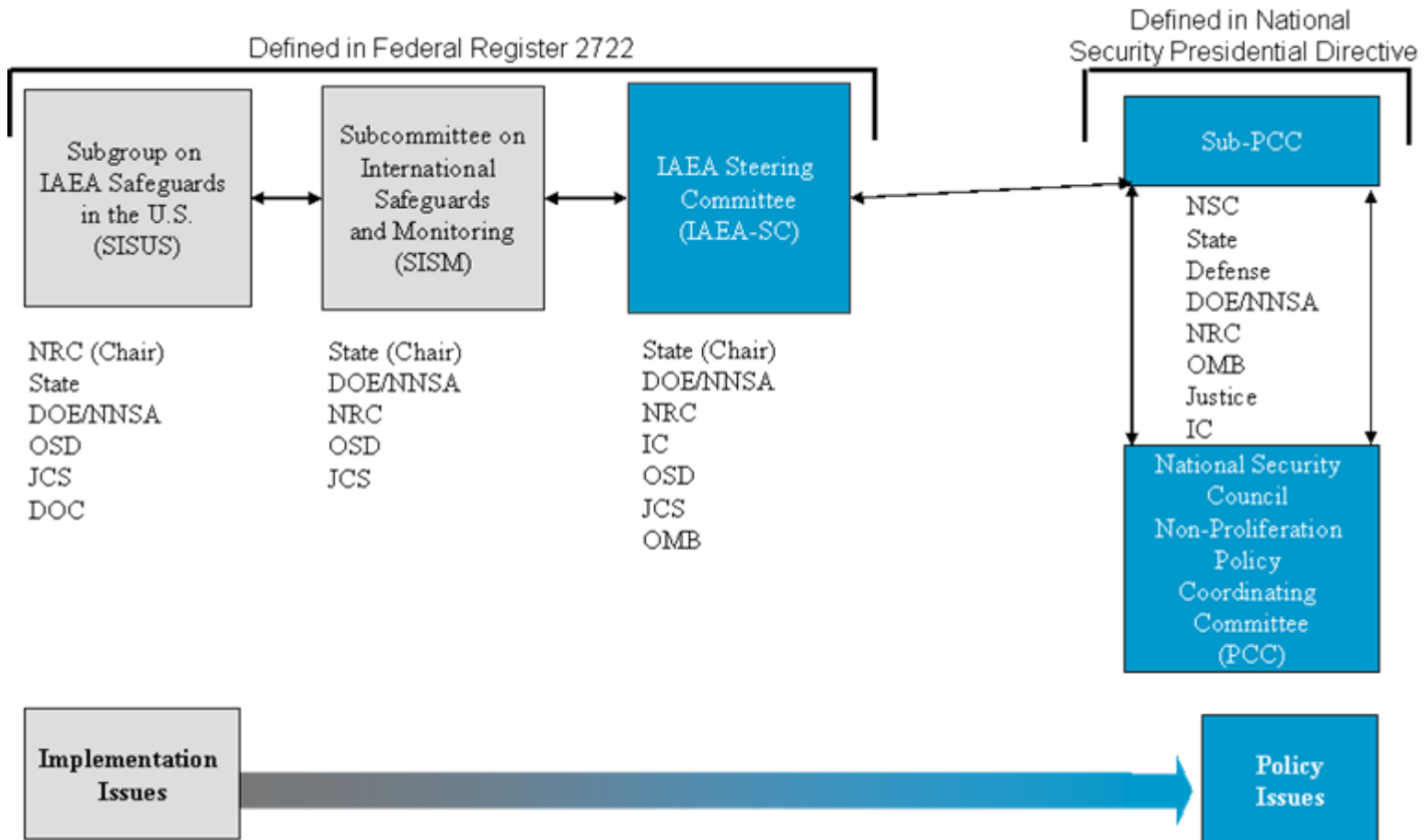

# **U.S.-IAEA Coordination**

- **Semi-Annual US-IAEA Safeguards Implementation Meetings**
  - Washington, D.C.
  - Vienna, Austria



# U.S.-IAEA Coordination

- Inspection Facilitation
  - Pre-approved list of designated inspectors
  - Multi-visit visas
  - Safety training requirements
  - Site access training requirements
  - Escorting
  - Authenticated shared equipment
  - Equipment installation support
  - IAEA office and work space

## **U.S.-IAEA Coordination**

- Reporting
  - U.S. Nuclear Materials Management and Safeguards System (NMMSS)
    - Inventory Change Reports, Material Balance Reports, Physical Inventory Listings
    - Nuclear material exports and imports
    - Semi-annual reconciliation
    - Semi-annual transit matching reconciliation
  - Export Approvals for Equipment and Material

## **U.S.-IAEA Coordination**

- **Safeguards Implementation Funds**
  - Regular Budget
  - Extra-budgetary for inspections
  - Extra-budgetary for equipment
  - Extra-budgetary for technology development

# U.S. Safeguarding Experience

- U.S. facility experience from 1981-Present
  - Spent fuel pool storage facility
  - Reactors (6)
  - Fuel fabrication facilities (6) - 4 reporting
  - Gas centrifuge enrichment plant
  - HEU storage vault - active
  - Pu storage vault (3) - 2 active
  - HEU Downblending facility

# IAEA Inspections in the U.S.

- Research (3) and Power Reactors (1) (1962-1963)
  - Test IAEA inspection procedures on plants of different designs and functions
- Yankee Rowe Nuclear Power Plant (1964-1968)
  - Inspect and verify declarations related to procurement, burn-up, and disposition of fuel
- West Valley Reprocessing Plant (1968-1970)
  - Verification of Yankee Rowe fuel reprocessing

# **IAEA Inspections in the U.S.**

- Research Reactor Storage Pool (1981-1983)
  - Demonstration and refinement of IAEA safeguards approach
  - Testing of safeguards equipment and measures

# IAEA Inspections in the U.S.

- Nuclear Power Reactors (1981-1988)
  - 6 reactors
    - BWRs and PWRs
    - Different facility configurations
  - Demonstration and refinement of IAEA safeguards approach
  - Testing of safeguards equipment and measures

# IAEA Inspections in the U.S.

- LEU Fuel Fabrication Plants (1981-1992)
  - 6 plants
    - Large throughput facilities
    - Dry and wet conversion processes
    - Pellet manufacture only; assembly manufacture only; and combined operations
  - Demonstration and refinement of IAEA safeguards approach
  - Testing of safeguards equipment and measures
  - 1<sup>st</sup> test of short notice random inspection (SNRI)-mailbox approach



# IAEA Inspections in the U.S.

- Gas Centrifuge Enrichment Plant (1983-1985)
  - 8.8 Million SWU (if fully constructed)
  - Hexapartite Safeguards Project
  - New technology developed
    - Load cell based weighing system
    - Cascade header enrichment monitor
    - Gas sampling cart
    - Neutron flux monitor
    - SNRI-mailbox approach concept

# IAEA Inspections in the U.S.

- HEU and Plutonium Storage Facilities (1994- )
  - 3 storage vaults and a container storage facility
  - IAEA verifies removal of former weapons nuclear material from national security programs
  - Technology advances
    - Transmission of remote monitoring data
    - Authenticated verification of Pu containers by calorimetry
    - Seals
    - Change detection surveillance cameras

# IAEA Inspections in the U.S.

- Small-scale HEU Downblending Facility (1996-2000)
  - ~0.1 MT HEU per year
  - Verification measurements on received oxides and shipped nitrates
  - Minor isotope analysis for verification of downblending
  - Unattended monitoring of downblending in pencil tanks
    - Volume, enrichment, U concentration

# IAEA Inspections in the U.S.

- UF6 down blending facility (1997-1998)
  - SNRI-Mailbox approach
  - Continuous unattended measurements
    - Weight and enrichment
  - New technology
    - Authenticated operator load cells
    - Integrated camera and scale system
    - Motion-activated surveillance

# IAEA Inspections in the U.S.

- Large HEU down blending facility (1999-2006)
  - ~ 10 MT HEU per year / ~100 MT LEU product per year
  - Efficiency of safeguards effort
    - Reliance on verification technology
  - Continuous, unattended flow measurements
    - Volume, enrichment, U concentration
    - Verification of HEU down blending
  - Continuous, unattended inventory measurements
    - Volume, enrichment, U concentration
  - New technology
    - Data authentication box for mailbox declarations
    - Coriolis flow monitors



# **Session 3: U.S. Eligible Facilities List**

**Bruce W. Moran**  
**U.S. Nuclear Regulatory Commission**

# U.S.-IAEA Safeguards Agreement

- “The United States shall, ..., provide the [IAEA] with a list of facilities within the United States not associated with activities with direct national security significance to the United States and may, ..., add facilities to or remove facilities from that list as it deems appropriate.”
  - Revisions to the Eligible Facilities List are submitted for a 60-day Congressional review before they are submitted to the IAEA.
- “The [IAEA] shall, from time to time, identify to the United States those facilities, selected from the then current list provided by the United States in accordance with Article 1(b) in which the [IAEA] wishes to apply safeguards, in accordance with the terms of this Agreement.”
  - The United States submits design information to the IAEA only for those facilities that have been placed on the Eligible Facilities List and that have been selected by the IAEA for the application of safeguards.

# **Addition to the Eligible Facilities List**

- Nomination for consideration
  - Announcement of safeguards significant facility
  - Request for updating Eligible Facilities List
- Security evaluation to identify associated activities of direct national security significance
- Executive Branch approval for addition to List
- Congressional review of proposed additions to List
- Submittal to IAEA



## **U.S. Eligible Facilities List**

- More than 300 NRC and DOE facilities have been listed since 1980
  - Facilities removed when closed and decommissioned
- 265 facilities on current list



# **Session 4: Additional Protocol**

**Thomas A. Grice**  
**U.S. Nuclear Regulatory Commission**

**August 2007**

# Additional Protocol Objective

- General: To detect undeclared nuclear material and activities in non-nuclear weapons states
- U.S.: To promote U.S. nonproliferation goals by demonstrating that the Additional Protocol does not place non-nuclear weapon states at a commercial disadvantage

# Background

- Comprehensive safeguards agreements with IAEA began in 1970s
  - U.S. Voluntary Offer Agreement in 1980
- Access and reporting only on facilities with nuclear materials (accountancy verification)
- Undeclared nuclear weapons program in Iraq identified need for increased access and verification authority for IAEA
- The Additional Protocol will make it more difficult for a country to hide undeclared activities

# Additional Protocol Scope

- Additional and broader information on nuclear-related activities in United States
  - Declaration of activities without nuclear materials
- Additional and broader IAEA access to nuclear-related activities
  - Verification of scope of declared activities
- Facilitated administrative requirements
  - Enhanced designation of IAEA inspectors
  - Multiple entry visas for IAEA inspectors

## **IAEA Additional Protocol Implementation**

- Verification not mechanistic or systematic
  - Not based on size of country's nuclear program
- Resolve questions and inconsistencies
  - Inconsistencies in all information received from U.S.
  - Inconsistencies between U.S.'s declarations and all other information received by IAEA
  - IAEA inspector suspect that something is wrong
- IAEA will first seek information to resolve question or inconsistency

# U.S. Additional Protocol Status

- Signed by United States in June 1998
- Approved by Senate on March 2004
- Implementing Legislation signed December 2006
- Executive Order
- Regulatory changes
- Implementation preparations
- Ratification by President
- Entry into Force
- Initial declaration on locations to IAEA within 180 days of entry into force

# Requirements

- Report information on certain nuclear fuel cycle-related activities
  - Annual reporting; quarterly for exports
- Provide IAEA with access to verify accuracy of declarations
- Exception
  - National Security Exclusion of all activities, locations, and information of direct national security significance to the United States



# U.S. Licensee Declared Activities

- Certain nuclear fuel cycle-related R&D
- Activities on sites of certain nuclear facilities
- Certain nuclear fuel cycle-related manufacturing
- Mining, milling, and concentration plants
- Import, export, or possession of materials preceding starting point of IAEA safeguards
- Export of certain nuclear fuel cycle-related equipment, heavy water, and certain graphite
- Location of IAEA-exempted or terminated nuclear materials

# Research and Development

## Category 1: Article 2.a(i)

- Government-affected R&D
  - Funded, specifically authorized or controlled by, or carried out on behalf of U.S. Government
  - DOE-funded NERI, INERI, AFCI, NEER, and INIE research and NRC-funded safety research at universities
  - Includes NRC-licensed activities
- Most fuel cycle-related processes
  - Conversion, enrichment, fuel manufacture, reactors, etc
- Not involving direct use of nuclear material
- Activities related to process or systems development, does not include basic research

# Research and Development (cont)

## Category 2: Article 2.b.(i)

- R&D for which U.S. Government has no official knowledge
- Enrichment and irradiated fuel/waste processing only
- Not involving direct use of nuclear material
- Activities related to process or systems development, does not include basic research

# Sites of Nuclear Facilities

- Facility on current Eligible Facilities List
- Formerly or currently selected facility for which Design Information Questionnaire was submitted to IAEA
- BWXT Downblending, Areva-NP (WA and VA), Global Nuclear Fuels (NC), Westinghouse (SC), Salem NPP, Turkey Point NPP, San Onofre NPP, Arkansas I NPP

# Manufacturing Activities

- Only active manufacturing, construction or assembly during reporting year
  - Enrichment technology major components
  - Zirconium tubing
  - Reactor control rods
  - Heavy water
  - Nuclear grade graphite
  - Casks for irradiated fuel
  - Hot cells
  - Irradiated fuel chopping machines
  - Criticality safe vessels

## **Imports/Exports of Equipment and Material**

- Equipment and non-nuclear materials licensed by NRC for export
- NRC currently collects most information required to be reported
- No additional reporting may be required
- IAEA may request to verify information on imports of covered equipment and material
- Most importing locations expected to be licensees

# **Uranium and Thorium Mining, Milling, and Concentration Plants**

- All operating, stand-by, and closed locations
- Includes in-situ leach mines, mills, and by-product recovery from other ore processing activities
- Other uranium and thorium recovery plants

# Impure Source Material

- Possession of source material preceding the starting point of IAEA safeguards
  - Uranium ore concentrates
  - By-product from other metal purification
- Import and export of impure source material for non-nuclear end uses



# **IAEA Exempted or Terminated Nuclear Material**

- No IAEA-exempted or terminated nuclear material in IAEA records for the United States

# Information Collection, Management and Reporting

- NRC and Commerce developing joint report forms
- Common information placed on separate form to eliminate repetitive entries
- Forms designed to limit entry of free text
- Previously reported information will populate forms to minimize data entry
- Licensees required to use web-based forms

# Information Collection, Management and Reporting (cont)

- NRC and Commerce will share system for receiving and reviewing reports
  - Web-based forms for data entry
  - NRC review of reported information for acceptability
- National security agencies will be informed of locations from which information is to be collected
  - NRC reporting activities are not national security activities
- DOE will collect information from DOE sites and submit to Commerce Department

# Reporting Schedule

- Initial declarations on activities are due within 180 days after entry-into-force (EIF) of the Protocol
- Annual updates
- Quarterly declarations of fuel cycle-related equipment exports
- Some declarations are due only at specific request by IAEA (e.g., equipment imports)

# IAEA Complementary Access

- Accesses are infrequent – in 2006 IAEA conducted 134 accesses in 75 countries with AP in force (accesses in 43 of 75 countries)
- Most accesses occur in conjunction with scheduled IAEA material accountancy inspections (127 of 134 were on sites of inspected facilities)
- Limited nonproliferation purpose for accesses in United States
- IAEA access requests expected to be rare

# **IAEA Complementary Access (cont)**

- IAEA notification at least 24 hours before access to occur unless performed during routine inspection (at least 2 hours)
- IAEA expected to seek resolution of concern before seeking access
- Reporting entity will identify to NRC managed access needed to protect proprietary information and to meet safety and security regulations
- Safety and security escort by installation
- NRC escort required; other agencies expected
- U.S.-approved equipment

# Protections

- National Security Exclusion
- Managed access
  - Protect activities, locations, and information of direct national security significance
  - Protect commercial and proprietary information
  - Meet health, safety, and physical protection requirements at installations

# Managed Access Measures

- Shrouding/Removal of sensitive information
  - Turn off computers, data indicators/loggers, etc.
  - Removal of sensitive papers
- Obscure viewing of sensitive information
  - Reduced lighting in sensitive areas
  - Viewing from a distance or from selected locations or angles
  - Careful selection of access routes, including use of non-normal entrances and exits
- Cessation of sensitive operations and removal of employees from the area
- Restriction of IAEA verification measures to those relevant to the inspection purposes



# IAEA Access Facilitation

- Notification of IAEA request immediately after NRC informed
- NRC staff on-location as soon as possible to provide training and assist licensee preparations
- Entry Briefing
  - IAEA inspectors
  - NRC and other U.S. Government personnel
  - Licensee

# NRC Status

- NRC Rulemaking
  - Broadens scope of 10 CFR Part 75
    - Includes all NRC and Agreement State licensees versus only licensed facilities
  - Rule changes incorporate Additional Protocol requirements into existing Part 75
    - Additional information to be reported
    - Additional IAEA access
    - Also amends 10 CFR Parts 40, 50, 60, 62, 70, 76, 95, 110, and 150
  - Rulemaking awaiting Office of Management and Budget information collection approvals
    - Final rule
    - Coordination with Commerce Department rulemaking

## **NRC Status (cont)**

- Guidance Document Development
  - Who must report
  - Reporting guidance and instructions
  - Complementary Access guidance
  - Licensee notifications and communications

# U.S. Government Actions

- Outreach to nuclear fuel cycle-related industry
- Development and testing of Additional Protocol database and reporting systems
- Identification of entities required to report
- Vulnerability assessments to protect national security and business sensitive information at DOE/DOD related facilities
  - Licensees with non-DOE/DOD facilities are responsible for conducting vulnerability assessments to protect their business sensitive information
- Information, training, and preparations for implementation of Additional Protocol



# **Session 5: 10 CFR Part 75 Regulations**

**Thomas A. Grice  
U.S. Nuclear Regulatory  
Commission**

**August 2007**

# Nonproliferation Treaties and Agreements

- Nuclear Nonproliferation Treaty
- U.S.-IAEA Safeguards Agreement
  - Eligible Facilities List of all source and special nuclear material facilities
  - Excludes facilities with activities of direct national security significance to the United States
  - Includes only facilities
  - IAEA selection of facilities from the list
- Protocol to the Agreement – Reporting
- Additional Protocol (pending)

# U.S. Regulatory System

- U.S. Atomic Energy Act of 1954
  - Responsible organizations
  - By-product, source, and special nuclear material
  - Licensing of installations
  - Inspection and enforcement
  - International activities (including import/export)
  - Information and technology protection
- Energy Reorganization Act of 1974
  - Created NRC and Energy Research and Development Administration (DOE precursor)
- Administrative Procedures Act
  - Regulatory processes

# U.S. Regulatory System

- 10 CFR Part 74 – Material Control and Accounting of Special Nuclear Material
  - Graded approach to nuclear material regulation
  - Performance objectives versus prescriptive text
  - Regulations supplemented by guidance
  - Fundamental Nuclear Material Control Plan is license-specific agreement specifying how licensee will meet regulatory objectives



# 10 CFR Part 75 - Implementation of US-IAEA Safeguards Agreement

- 10 CFR Part 75
  - Regulation referenced from other domestic regulations
  - Promulgated in 1980
  - Few revisions
- Current Rulemaking
  - Inserts Additional Protocol treaty compliance requirements into existing Part 75
  - Rearrangement of Part 75
    - Eliminate redundancy in requirements
    - Improve organization of information

# 10 CFR Part 75

- Purpose
  - Implement U.S.-IAEA Safeguards Agreement, including protocols and subsidiary arrangements, at NRC and Agreement State licensees.
- Scope
  - All persons licensed to possess source or special nuclear material.
  - All license applicants to construct a facility or receive source or special nuclear material.
  - Except for facilities of direct national security significance to the United States.
  - When notified in writing by the NRC.
- Exemptions
  - SNM in grams quantities (e.g., in sensing component of equipment)
  - Nuclear material in non-nuclear activities

# 10 CFR Part 75

- Definitions
- Facility and Location Reporting
  - Address for submittal of reports
  - Reports required to be in computer readable format
- Notifications
  - Licensee must notify NRC if planning activity that may make them subject to U.S.-IAEA Safeguards Agreement
  - Selection by IAEA from Eligible Facilities List
  - Additional Protocol reporting requirement
  - Deselection by IAEA or termination of reportable activity

# 10 CFR Part 75

- IAEA Inspections
  - Types
    - Ad Hoc
    - Routine
    - Special
    - Complementary Access
  - Notification of inspection request
  - Inspector access authorization
  - Authorized inspector activities
  - Assistance to IAEA inspectors
  
- Information Collection Requirements
  - Office of Management and Budget authorization required

# 10 CFR Part 75

- Facility information
  - Information required to complete design information questionnaire
  - Site map and information on all buildings
  - Updates to reflect modifications to facility information
  - Required use of forms and formats
  - Pertinent information on physical protection requirements, health and safety rules, and managed access to site and facility
- Location information
  - Information required under Additional Protocol
  - Required use of forms and formats
  - Pertinent information on managed access to location

# 10 CFR Part 75

- Reporting
  - Provision of information to IAEA
  - Withholding of sensitive information
  - Access to sensitive information
- Facility attachment
  - Annex to U.S. Subsidiary Arrangement specifying facility specific agreements for safeguards implementation
    - Facility Attachments under Safeguards Agreement
    - Transitional Facility Attachment under Protocol to Agreement
  - Enacted by license amendment
  - Licensee permitted to support development of facility attachment

# 10 CFR Part 75

- MC&A General Requirements
  - Facility shall establish, maintain, follow, and retain written MC&A procedures
  - Required MC&A activities may exceed those required under 10 CFR Part 74
- Accounting records
  - Inventory changes, Measurement results, Adjustments and corrections
  - Material identification, Batch data, Source data
  - Inventory change dates, Originator/shipper, Recipient/receiver
- Operating records
  - Operating data on changes to nuclear material location or content
  - Calibration data and information
  - Physical inventory procedures
  - Inventory reconciliation procedures

# 10 CFR Part 75

- Accounting reports
  - General requirements
  - Initial inventory reports
  - Report forms
  - Inventory change reports
  - Material balance reports and physical inventory listings
  - Special reports
- Advance notification
  - Exports and Imports
  - Domestic transfers to/from non-eligible facility
  - Advance notification times
  - Content of advance notifications



# 10 CFR Part 75

- Expenses
  - IAEA reimburses licensees for extraordinary expenses resulting from IAEA requests
  - Agreement in advance on actions and costs
  - Reimbursement schedule in Facility Attachment
- Enforcement
  - Issuance of orders to secure compliance
  - Injunction or court order to prevent violation of treaty provisions
  - Court order for payment of civil penalties
  - License modification, suspension or revocation



**Session 6:  
Design Information  
Questionnaire**

Bruce W. Moran,  
U.S. Nuclear Regulatory Commission

# Design Information

- Definition
  - information concerning nuclear material subject to safeguards under the agreement and the features of facilities relevant to safeguarding such material.
- Design information includes
  - the facility description; the form, quantity, location, and flow of nuclear material being used; and procedures for nuclear material accountancy and control.
- Used by IAEA
  - to design the facility safeguards approach;
  - to determine material balance areas;
  - to select key measurement points and other strategic points;
  - to develop the design information verification plan; and
  - to establish the essential equipment list.”

# Design Information

- Design information is submitted to the IAEA
  - using the IAEA Design Information Questionnaire (DIQ).
- Preliminary information on any new nuclear facility
  - as soon as the decision is taken to construct the facility
- Information on the safeguards-relevant features of facility design during
  - project definition,
  - preliminary design,
  - construction, and
  - commissioning.
- Facility design information is to be provided for any safeguards relevant changes in operating conditions
  - throughout the facility life cycle.

## **DIQ Submittal**

- Design Information Questionnaire is completed by the facility operator
- Submitted to the NRC for review.
- NRC specifies revisions that should be made.
- NRC-approved questionnaire submitted for U.S. Government concurrence
- U.S. Department of State transmits to IAEA.

# IAEA Design Information Review

- Design Information Evaluation
  - Determination by IAEA that the State has provided all relevant descriptive and technical information needed to design a safeguards approach for a specific facility.
- Design Information Verification
  - Initial DIV is performed on a newly built facility to confirm that the as-built facility is as declared.
  - Periodic DIV on existing facilities to confirm the continued validity of the design information and of the safeguards approach.
  - DIV is a continuing right throughout all phases of a facility's life cycle until the facility has been decommissioned for safeguards purposes.

# DIQ Responses

- Complete, yet concise, answers to the questions
  - Attachments contain explanations and drawings that provide explanatory details
- Location and layout of the facility
- General operations of the facility
- How much and how nuclear material is received and flows through the facility (including waste materials)
- Structures containing the nuclear material (e.g., containers, tanks, hoppers, piping, etc.)
- How and where the nuclear material is stored
- How the nuclear material values are determined
- Safety and security rules that will affect the conduct of an inspection

# DIQ Questions - Common

1. Name of facility
2. Location and Postal Address
  - Including maps to facilitate inspector travel from airport to facility
3. Owner (legally responsible)
4. Operator (legally responsible)
5. Facility description (main features only)
6. Facility purpose
7. Status (planned; under construction; in operation)
8. Construction schedule dates (if not in operation)
9. Normal operating mode (shifts, days per week)
10. Facility layout
  - structural containment, fences, access, nuclear material storage areas, laboratories, waste disposal areas, routes followed by nuclear material, experimental and test areas, etc.
11. Site layout
  - site map showing in sufficient detail: location, premises and perimeter of facility, other buildings, roads, railways, rivers, etc.
12. Names and/or title and address of responsible officers



# DIQ Questions – Enrichment Plant

- 13 Facility description
  - Including process stages, storage areas, and material withdrawal points
- 14 Process description
  - Including sampling and key measurement points
  - Including material balance areas and inventory locations
- 15 Design capacity
  - Including throughput and energy consumption
- 16 Anticipated annual throughput
- 17 Main material description:
  - chemical and physical form,
  - throughput and enrichment range,
  - Batch size/flow rate and Campaign period,
  - Maximum capability as concentration of top product,
  - Storage inventory,
  - Frequency of receipt and shipment
- 18 Waste Material
  - Source and form
  - Storage inventory range, method and frequency of recovery or disposal

# DIQ Questions – Enrichment Plant

- 19 Container and storage area description
  - Storage and shipping containers
  - Filling and emptying procedures
- 20 Measured discards and retained waste
  - Percent of throughput
- 21 Inventory
  - In-Process
  - Other locations
- 22 Maintenance, decontamination, clean-out
- 23 Basic measures for physical protection of nuclear material
- 24 Specific health and safety rules for inspector compliance

# DIQ Questions – Enrichment Plant

- 25 Nuclear material accountancy system description
- description of the nuclear material accountancy system,
  - the method of recording and reporting accountancy data and establishing material balances,
  - the procedures for account adjustment after inventory and correction of mistakes,
  - Shipments and receipts
  - Physical inventory
  - Measured discards and retained waste
  - Operating records and accounts
  - Adjustments and corrections

# DIQ Questions – Enrichment Plant

## 26 Key Measurement Points

- Identification
- Chemical and Physical form of material
- Sampling procedure and equipment used
- Measurement/analytical method and equipment
- Random and systematic errors
- Conversion of source to batch data
- Calculations and error propagation
- Calibration of equipment
- Measurement control
- Statistical evaluation of data

## 27 Overall Limit of Error

- Shipper-receiver differences
- Book inventory
- Physical inventory
- Inventory difference/material unaccounted for

## 28 Optional information

## **DIQ Responses Should Not Provide**

- Information that is not IAEA-safeguards relevant
- Specific information on how process equipment works
- Specific information on the design of equipment and equipment operating parameters
- Information on security systems and procedures that would not impact the IAEA inspections
  - e.g., camera and alarm locations, guard patrol procedures, etc.
- Classified, proliferation sensitive, or proprietary or commercially sensitive information
  - unless the information is necessary for the IAEA to develop and implement the safeguards approach.

# Classified and Sensitive Information

- IAEA safeguards-relevant information that is
  - RESTRICTED DATA cannot be provided to the IAEA.
  - NATIONAL SECURITY INFORMATION should not be included in the DIQ.
  - Highly sensitive proprietary information should not be included in the DIQ.
- NSI and proprietary information can be provided to the IAEA at the facility and stored at the facility under IAEA seal
- NSI and proprietary information can be provided to the IAEA through official U.S. Government channels (e.g., U.S. Embassy in Vienna, Austria).

# Facility Attachment

- Annex to Subsidiary Arrangements
  - Prepared for each facility selected from Eligible Facilities List
  - Describes arrangements specific to facility
- Formal agreement between U.S. and IAEA
- Design Information Questionnaire forms basis for Facility Attachment
- Establishes requirements for safeguards inspections

# Facility Attachment

- 1 Identification of Facility
  - Name, Location, Description
- 2 Information on Facility
  - DIQ reference, Storage of design information
- 3 Safeguards Measures
  - Accountancy, containment and surveillance, strategic points, safeguards termination, exemptions
- 4 Specifications for Key Measurement Points
  - Flow KMPs, Inventory KMPs



# Facility Attachment

## 5 Records System

- Accounting records, operating records, retention of records

## 6 Reports System

- Inventory change reports, concise notes, material balance reports, physical inventory listings, special reports

## 7 Inspections

- Mode and frequency of inspections, Scope of inspections, Arrangements for use of operator equipment, Sampling, Facility contacts, Services and charges, Facility rules and regulations

## 8 IAEA Statements

- Results of inspections, Annual conclusions

# **Transitional Facility Attachment**

- For facilities selected only for material accountancy reporting under the Protocol to the U.S.-IAEA Safeguards Agreement



# **Session 7: Model Schedule for IAEA Safeguards**

**Bruce W. Moran**  
**U.S. Nuclear Regulatory Commission**

# Generic Requirements

- Code 3.1, Subsidiary Arrangements
  - Preliminary design information
    - Upon decision to construct facility
  - Early Design Information Questionnaire
    - 180 days before construction begins
  - Final Design Information Questionnaire
    - 180 days before nuclear material received

# U.S. Constraints

- Addition to U.S. Eligible Facilities List
- Selection by IAEA
  - Provision of information within 45 days of selection

# Model Schedule – pre license

- - 48 mos Decision to pursue licensing of new facility
- - 42 mos First pre-licensing conference held with NRC
- - 40 mos Nomination to Eligible Facilities List (EFL)
- - 38 mos IAEA safeguards requirements discussions
- - 36 mos Preliminary IAEA safeguards approach concepts
- - 28 mos EFL acceptability review completed
- - 24 mos **License application submitted**

# Model Schedule – pre-license

- - 22 mos Facility placed on EFL
- - 22 mos Preliminary design information to IAEA
- - 20 mos IAEA expresses interest in selecting facility from EFL
- - 20 mos US-IAEA conceptual safeguards approach discussions
- - 18 mos IAEA selects facility from EFL
- - 16 mos Preliminary DIQ submitted (180 days before license)
- - 14 mos Conceptual safeguards approach agreed
- - 12 mos Effectiveness and security evaluations of approach
- - 12 mos Conceptual safeguards approach agreed
- - 12 mos Revise facility design to facilitate IAEA safeguards
- - 12 mos IAEA technical measures and equipment development initiated
- 0 mos **License approved and construction begins**

# Model schedule – post-license

- + 2 mos IAEA design information verification inspections begin
- + 2 mos Discussions begin on IAEA inspection measures and implementation details
- + 6 mos Purchasing and qualification of IAEA safeguards equipment
- + 18 mos Final DIQ submitted (180 days before material received)
- + 18 mos Installation and testing of IAEA equipment at facility
- + 22 mos Facility attachment negotiations completed
- + 22 mos Initial inventory declaration (zero inventory)
- + 24 mos **Nuclear material received**
- + 24 mos IAEA inspections begin
- + 36 mos Facility approved for routine operations





# **Session 8: IAEA Safeguards Inspection Overview**

**Brian G. Horn**  
**U.S. Nuclear Regulatory Commission**

# U.S.-IAEA Safeguards Agreement

- “The United States shall, ..., provide the [IAEA] with a list of facilities within the United States not associated with activities with direct national security significance to the United States and may, ..., add facilities to or remove facilities from that list as it deems appropriate.”
  - Revisions to the Eligible Facilities List are submitted for a 60-day Congressional review before they are submitted to the IAEA.
- “The [IAEA] shall, from time to time, identify to the United States those facilities, selected from the then current list provided by the United States in accordance with Article 1(b) in which the [IAEA] wishes to apply safeguards, in accordance with the terms of this Agreement.”
  - The United States submits design information to the IAEA only for those facilities that have been placed on the Eligible Facilities List and that have been selected by the IAEA for the application of safeguards.

## **U.S.-IAEA Safeguards Agreement**

- “The safeguards applied by the IAEA under this agreement ... shall be implemented by the same procedures followed by the Agency in applying its safeguards on similar materials in similar facilities in non-nuclear weapon states ....”
- “The United States shall take the necessary steps to ensure that [IAEA] inspectors can effectively discharge their functions under this Agreement.”

# Inspection Guidelines

- IAEA safeguards inspections
  - shall be implemented in a manner to avoid undue interference in the operation of nuclear facilities;
  - shall be implemented in a manner to be consistent with prudent management practices required for the economic and safe conduct of nuclear facilities;
  - shall make every effort to ensure optimum cost-effectiveness to the extent that technology permits;
  - shall arrange visits and activities of IAEA inspectors to reduce to a minimum the possible inconvenience and disturbance to the peaceful nuclear activities inspected.

# Inspection Guidelines

- IAEA safeguards inspections:
  - shall require only the minimum amount of information and data consistent with carrying out the IAEA’s responsibilities under the Agreement;
  - shall examine on premises in the United States design information which the United States regards of particular sensitivity;
  - shall arrange visits and activities of IAEA inspectors to ensure protection of industrial secrets or other confidential information that may come to the inspector’s knowledge;
  - shall take every precaution to protect commercial and industrial secrets and other confidential information coming to the IAEA’s knowledge.

# Selection Process

- Before the IAEA selects a facility from the Eligible Facilities List,
  - the U.S. Government and the IAEA hold discussions to assist the IAEA in determining whether to select the facility.
  - IAEA is not obligated to perform safeguards inspections at U.S. facilities.
  - IAEA selects only those facilities in the United States that will further IAEA safeguards and nuclear nonproliferation goals.
- The IAEA officially notifies the United States of its decision to select.
- The NRC, by written notice, informs the licensee, applicant, or certificate holder that it was selected.
- U.S. submits beginning inventory declaration within 30 days.
- U.S. submits design information questionnaire within 45 days.
- Licensee permits the IAEA to conduct inspection visits to verify the accuracy of information declared by the U.S. Government to the IAEA.

# Notification of Selection

- First Letter
  - Notify facility that IAEA has selected it for application of safeguards
    - 10 CFR Part 75 applies,
    - Site shall prepare and submit a Design Information Questionnaire to the NRC,
    - Site shall prepare and submit initial inventory.

# Notification of Selection

- Second letter
  - Notify facility that it may share classified information with IAEA, (e.g. up to Confidential National Security Information), and
  - Inform facility that its NRC-issued license will be amended to require it to comply with IAEA safeguards requirements and Facility Attachment.



# IAEA Inspectors

- Each inspector has been reviewed and approved by the U.S. Government to perform IAEA inspections within the United States.
- IAEA inspectors are employees of the International Atomic Energy Agency
- IAEA inspectors are Diplomats
- U.S. nationals will not inspect your facility

# Types of Inspections

- Ad hoc inspections
  - Preliminary safeguards measures agreed between the IAEA and the U.S. Government.
  - Begins with IAEA selection of the facility
  - Ends when a safeguards approach is formally approved in the Facility Attachment.
- Routine inspections
  - Safeguards approach formally approved in the Facility Attachment.
- Special inspections
  - Verify information in special reports
  - Obtain information when reports by the United States and routine inspections are not adequate for the IAEA to fulfill its responsibilities under the Agreement.

# Design Information Verification

- DIV
  - Activities carried out by the IAEA at a facility to verify the correctness and completeness of the design information provided by the State.
  - Conducted under all types of inspections.
  - An initial DIV is performed on a newly built facility to confirm that the as-built facility is as declared.
  - Performed periodically on existing facilities to confirm the continued validity of the design information and of the safeguards approach.
  - Continuing right of IAEA throughout all phases of a facility's life cycle until the facility has been decommissioned for safeguards purposes.

# Inspection Notifications

- IAEA inspections are announced in advance of the IAEA visit.
  - Unannounced, random inspections may be approved as part of the safeguards approach.
- NRC will verify that the inspectors designated for the visit are approved for conducting inspections in the U.S.
- NRC will notify the licensee in writing of the proposed visit as soon as possible after receiving notification from the U.S. Department of State.
- The licensee should inform the NRC immediately if the IAEA inspection cannot be accommodated on the specified date.

# Inspector Access

- NRC employee will, to the extent possible, accompany the IAEA inspector(s) during the visit.
- Licensee shall provide access to the IAEA inspectors who are designated and approved for the inspection.
- If an IAEA inspector arrives at the facility without advance notification
  - the licensee should immediately notify the NRC and seek approval before permitting the IAEA inspector to access the facility.

# Model Inspection Plan

## 1. IAEA Arrival at Installation

- Entry Point
- Presentation of IAEA credentials
- Receipt of IAEA equipment
- Badging
- Safety and Security Training

## 2. Pre-entry coordination briefing

- IAEA Office
- IAEA purpose of visit
- U.S. Government Host Team procedures
- Installation safety and security requirements
- Prohibited items, equipment, and activities
- IAEA equipment

# Model Inspection Plan, cont

3. Entry to installation
  - Security screening
    - Personnel
    - Equipment
  - Escorts
4. Pathway from Entry Point to Safeguarded Facility
  - On-Site Notifications
  - Controls
  - Shrouding
  - Confirmation that measures implemented

# Model Inspection Plan, cont.

5. Entry to Facility
  - Safety and security requirements
  - Managed access measures
    - Equipment status
    - Shrouding
    - Controlled routes
    - Equipment use
    - Photography
6. Control of Sensitive Information



# Model Inspection Plan, cont.

## 7. IAEA Office

- Operations
- Storage of IAEA and facility information
- Storage of IAEA equipment

## 8. Exit briefing



**Session 9:**  
**IAEA Safeguards Implementation at an  
HEU Downblending Facility**

Bruce W. Moran  
U.S. Nuclear Regulatory Commission

# 50 MT HEU Downblending Project

- Contract awarded – Sept 1998
  - HEU excess to national security needs
  - Downblending for use in nuclear reactors
- Safeguards approach discussions – Jan 1999
- Safeguards approach approved – July 1999
- Facility constructed – Sept - Nov 1999
- Safeguards equipment installation and testing – Nov 1999
- Downblending operations – Dec 1999-June 2006

# IAEA Safeguards Approach

- Objective
  - Verify quantity of HEU downblended to LEU
  - Minimize inspection resources
- Facility
  - Downblending tanks and attached process piping
- Verification
  - All batch transfers into and out from tanks
  - Tank inventory

# IAEA Safeguards Equipment

- Facility design
  - Seals
- Information
  - “Mailbox” data authentication module
- Solution Flow and Inventory
  - On-pipe: Coriolis Flow Totalizers
  - On-tank: Rosemount Pressure Transducer
- Concentration and Enrichment
  - NaI gamma spectrometers
- Electronics field cabinet
- Data collection cabinet

# Approach

- IAEA Safeguards Approach
  - Monthly inspections
    - 85 person days inspection (PDI) per year
  - Verified uranium flows and downblending
    - Operator mailbox declarations of all transfers
    - Continuous unattended measurements
    - Tracking batch material balance differences
    - Consistency of operations

# Approach

- Monitoring
  - Multiple measurement of flows and enrichments – pipe and tank
  - Consistency of operations
  - Multiple storage of data
    - Data loggers, field cabinet, data storage cabinet
    - Rapid retrieval of data from data storage cabinet

# Challenges

- Rapid development and deployment of measurement systems
  - Untested commercial flow monitors (operator and IAEA)
  - Operational changes in equipment locations and operating parameters
  - Used available IAEA equipment
  - Replacement and upgrading of equipment
- Use of process control measurement systems for accountability measurements
  - Measurement control
  - Exceeded design specifications for equipment



# Challenges

- High security facility
  - Special procedures for inspector access
  - Two-hour access to facility
- Classified material accounting information
  - Secure processing area for data review and storage
  - Special procedures for transfer of operator declarations
- State-of-health monitoring
  - Operator monitoring of status lights
  - Immediate notification of IAEA
  - Quick response by IAEA
  - Suspension of batch processing

# Problem Resolution

- Resolution of safeguards issues
  - High material throughput accelerated problems
  - Instrument failures
    - Redundancy of measurements and storage
    - Alarm response and resolution procedure
  - Measurement biases
    - Material balance differences accumulated quickly
    - Bias resolution and recalibration



**Session 10:  
HEU Downblending Facility  
Lessons Learned**

Brian Horn  
U.S. Nuclear Regulatory Commission

## **Goal**

- Ensure successful IAEA inspections.
- Enhance effectiveness and efficiency of safeguards implementation
- Minimize impacts on facility operations

## **Lessons Learned**

- NRC point of contact for IAEA safeguards
  - Facilitate inspections and assist facility
- IAEA Inspectors
  - International civil servants
  - may be very knowledgeable about your facility
- Openness and transparency
  - Explain your facility needs and constraints with the IAEA inspectors
  - Don't let the IAEA inspector be the first to identify a problem

# Safeguards Approach

- Sufficient time and information is needed before facility start-up to design an effective and efficient safeguards approach.
- Sufficient time is needed for IAEA and U.S. interactions to evaluate the proposed safeguards approach to ensure technical effectiveness and avoid equipment reliability problems.
- Sufficient time is required to design, purchase, assemble, and test IAEA monitoring equipment before it is required to begin monitoring activities.

# Information Reporting

- Establish direct data transfer capability
  - between the operator and NRC and
  - between NMMSS and NRC
  - eliminate the need to mail classified disks.
- Provide authorization for the direct transfer of certain types of facility-related information to the IAEA for use on site during an inspection.
  - records of process operations

# Measurements

- A strong measurement control and oversight program is required when on-line instruments are used for material accounting purposes.
- Measurement control program,
  - should be developed and designed for the operator and IAEA measurement systems
  - provide oversight of the accountability measurements to provide for early detection of biases,
  - provide statistical information on the performance of the instruments.
- Experience with measurement equipment in similar use conditions
  - provided before equipment is used in material measurement and verification applications.



# Continuous Operating IAEA Equipment - Reliability -

- IAEA equipment should be tested in a process environment before installation at the facility.
- IAEA equipment should be designed and tested to restart after a loss of electrical power to the equipment.
- Up-to-date operating and maintenance procedures should be stored with in-plant equipment
  - assure current procedures are available
  - minimize need for inspectors to carry a copy of the procedure into and out from the down blending facility.
- Maintenance actions that can be performed by the operator in the absence of the IAEA
  - should be established (e.g., change state of health light bulb)
  - components that can be replaced by the operator need to be available to the operator.

# Plant Services

- IAEA equipment power and reserve power needs
  - Established when the equipment requirements of approach are determined.
- IAEA equipment should have alarm mechanism
  - Identify that plant power has been lost to the system.
- Sufficient emergency and back-up power for any credible power loss
  - Ensure continuous operation of the IAEA monitoring equipment and data storage computers.
- IAEA electrical power circuits should be designed to accept emergency or portable power connection.
- Enclosures should be used to prevent accidental damage or contamination to IAEA seals from facility operations.
- IAEA safeguards should be designed into routine facility operations to ensure that it is routinely considered in all affected plant operations.
- Operating condition impacts on IAEA equipment should be recognized before system installed
  - Solution flow characteristics, air quality, temperatures
  - Corrosion of wiring connections, overheating.

# Safety

- Mechanism should be provided for inspectors to transmit their notes from inside to outside facility without removing potentially contaminated paperwork.
- Office supplies should be provided inside building to limit need by inspectors to access personal pens and notebooks.
- Covers should be provided for IAEA seals and equipment to protect the items from becoming contaminated.
- Operator should have procedure addressing medical emergencies involving IAEA inspection personnel
  - before inspections begin.

# Security

- Technical equipment inspections should be designed into the procedures for implementing the safeguards approach.
- All security requirements should be understood before development of the safeguards approach is completed.

# U.S.-IAEA Interactions

- Establish emergency action protocols
  - At the beginning of the project.
- Establish communications procedures
  - At the beginning of the project.
- Two operator escorts or one escort per IAEA inspector
  - Permit inspectors to work in separate areas
  - Ensure that at least one operator staff is present to serve as a runner to get needed information or materials.

## **U.S.-IAEA Interactions (cont)**

- List of costs that will be reimbursed by IAEA
  - Established before safeguards approach enters into force
  - Early agreement on list to be included in Facility Attachment.
- Facility Attachment should be developed in advance of safeguards implementation.
  - If full Facility Attachment cannot be agreed before safeguards implementation, approval should be provided for specific sections (e.g., reimbursements).

# NRC-Licensee Interactions

- Teamwork between the points of contact
- Separation of NRC facilitation staff from NRC staff with regulatory functions
  - Important to permit open NRC-operator exchanges on safeguards implementation problems and resolution of the problems.
- NRC staff should provide periodic briefings to operator management and staff
  - Maintain sensitivity to and awareness of IAEA safeguards goals and policies.
- NRC staff should provide briefings whenever there are changes in project scope or key project staff
  - Maintain manager awareness of the safeguards requirements and U.S. nonproliferation goals.

# **NRC-Licensee Interactions (cont)**

- Operator should provide a summary report to NRC after each inspection
  - Including IAEA statements that indicate concerns with the safeguards implementation.
- NRC and the operator need to hold periodic review meetings, separate from the inspection period,
  - Identify and discuss implementation concerns.
- An annual review meeting should be held with NRC and operator managers
  - Present status and conclusions of safeguards inspections.
  - During annual License Performance Review





# Session 11: Uranium Enrichment Plant Safeguards Overview

Bruce W. Moran  
U.S. Nuclear Regulatory Commission

# Background

- Hexapartite Safeguards Project (HSP) - 1983
  - Australia, Germany, Japan, Netherlands, U.K., U.S., with Euratom and IAEA as observers
  - Safeguards approach that would protect sensitive technology
  - Limited frequency unannounced access to cascade hall
  - Commitment by participants to make facilities eligible for IAEA safeguards and commitment by IAEA to apply safeguards

# Background

- New IAEA Model Safeguards Approach for Enrichment Plants - 2005
  - Enhanced effectiveness and efficiency of IAEA safeguards verification
  - Necessary for increased size and complexity of enrichment plants
  - Use advances in technical safeguards measures

# **Enrichment Plant Safeguards Objectives**

- Detect diversion of uranium from declared flows
- Detect production of undeclared, excess product
- Detect production of enrichments higher than declared, especially highly enriched uranium

# Detection of Diversion

- Timeliness goal of 1 year for Depleted/  
Natural/ Low-enriched Uranium (DNLEU)
  - HEU detection capability at one month
- Quantity goal of 75 kg U-235 for DNLEU
  - HEU detection capability for 25 kg U-235

# Detection of Diversion

- Material accounting
  - MBA structure
    - storage and process MBAs
    - MBA boundaries
    - Unified uranium or enrichment categories
  - Recordkeeping
    - Operating records
    - Material accounting records

# Detection of Excess LEU

- Verification of no undeclared feed or withdrawal points
- Verification of attached and detached cylinders
  - Declaration of all cylinder locations and movements
  - Short-notice random inspection
- Sealing of full and empty cylinders
- Flow monitoring

## **Detection of HEU**

- Limited frequency-unannounced access to cascade hall
  - Detect design changes and undeclared containers
  - NDA header measurements
  - Gas samples
  - Environmental sampling around cascade
  - Containment and surveillance
  - Frequency depends on capacity and transparency
- Environmental sampling at withdrawal locations



## **New IAEA Model Safeguards Approach for Enrichment Plants**

- Annual design information verification
- Annual physical inventory verification
- Verification of shipments and receipts for quantity and enrichment
  - Portable and installed weighing systems
  - Destructive and non-destructive enrichment measurements
  - Chemical purity assumed
- “Mailbox declarations” by the operator
- Monitoring of operator load cells
- Containment and surveillance
- Unannounced or short-notice random inspections
- Remote monitoring
- Limited Frequency Unannounced Access (LFUA) in cascade hall
- Environmental swipe sampling.

# Model Enrichment Plant

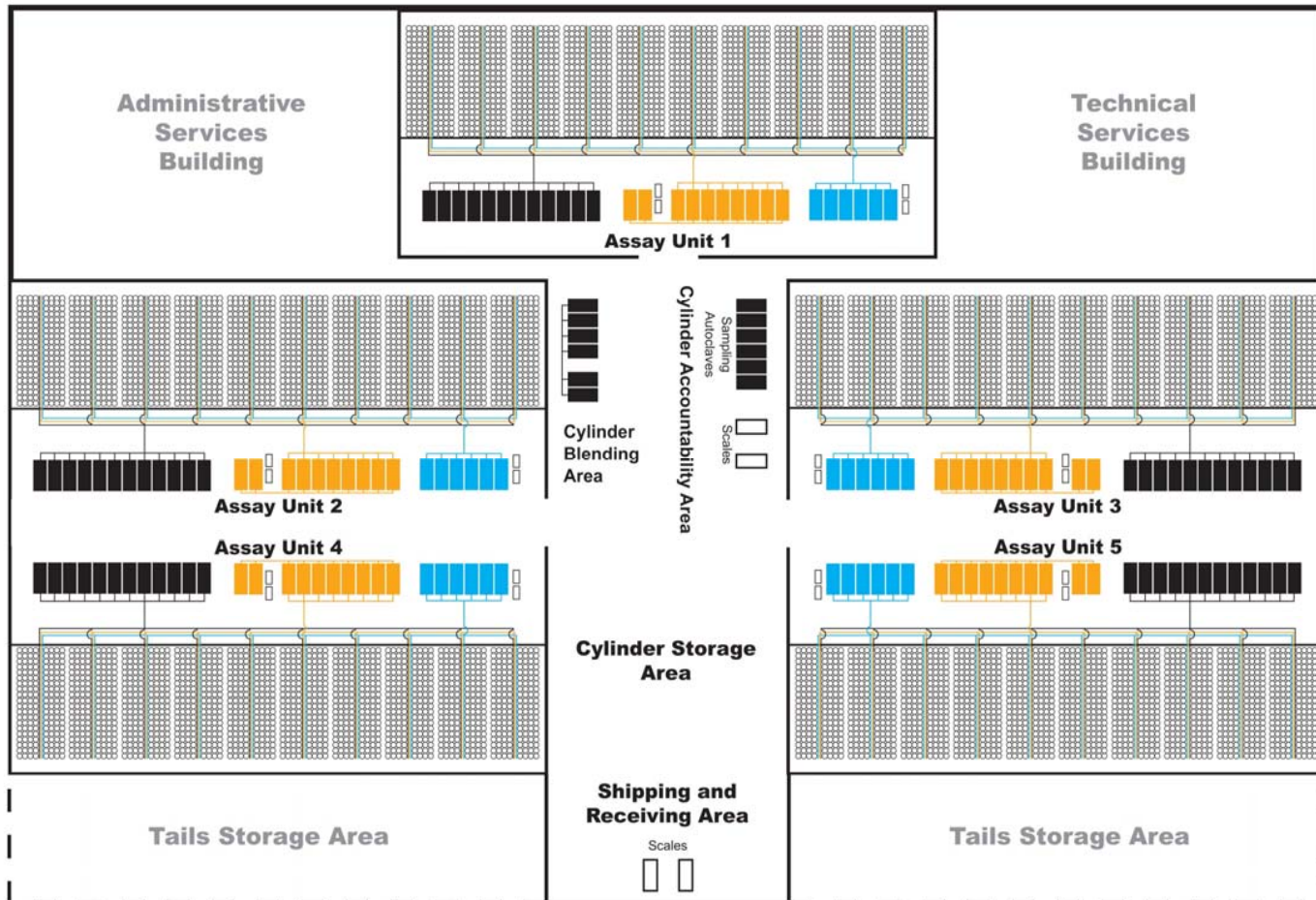

# Current IAEA Approach (HSP) – Example 1

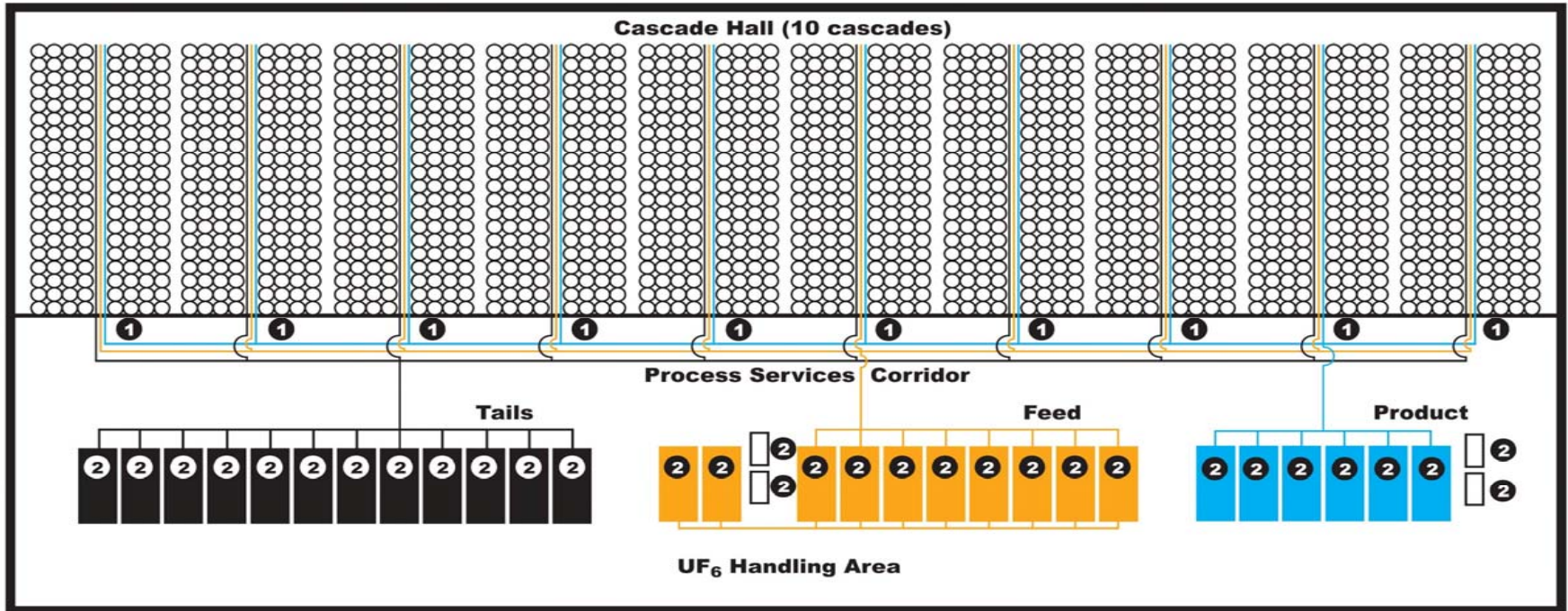

- ① Cascade Header Enrichment Monitor Measurement Location
- ② F/W Station Load Cell Monitor



# Current IAEA Approach (HSP) – Example 2

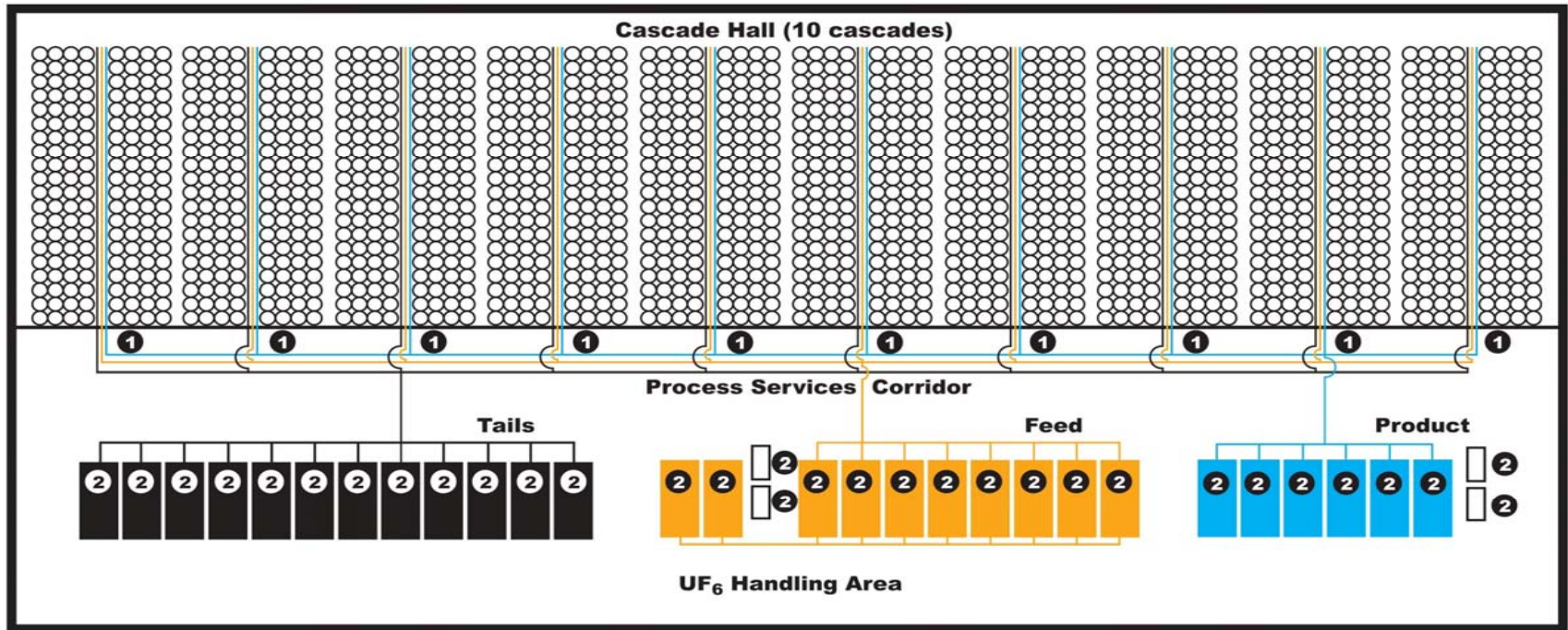

- ① Continuous Enrichment Monitor
- ② F/W Station Load Cell Monitor

# New IAEA Model Approach – Example 1

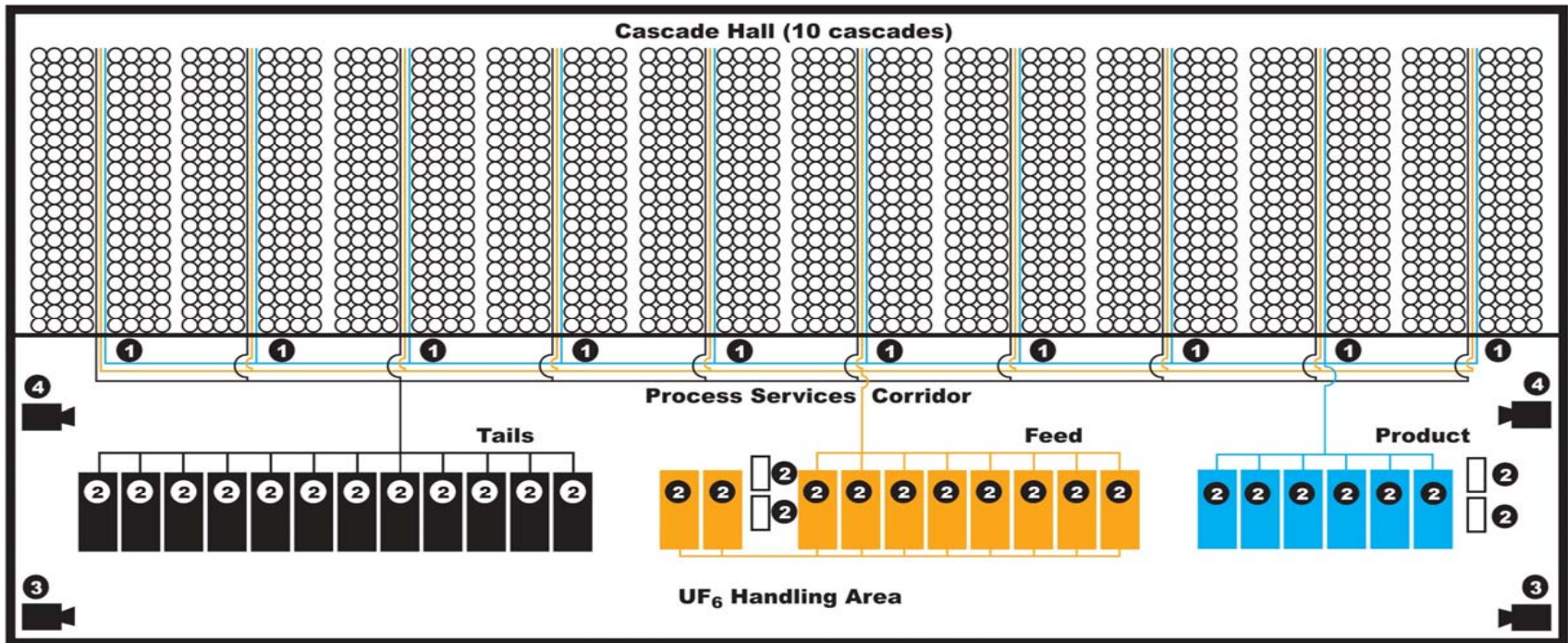

❶ Radiation Attributes Monitor

❷ Unattended F/W Station  
Load Cell Monitor

❸ F/W Surveillance camera

❹ Process Pipe Surveillance  
Camera



# New IAEA Model Approach – Example 2

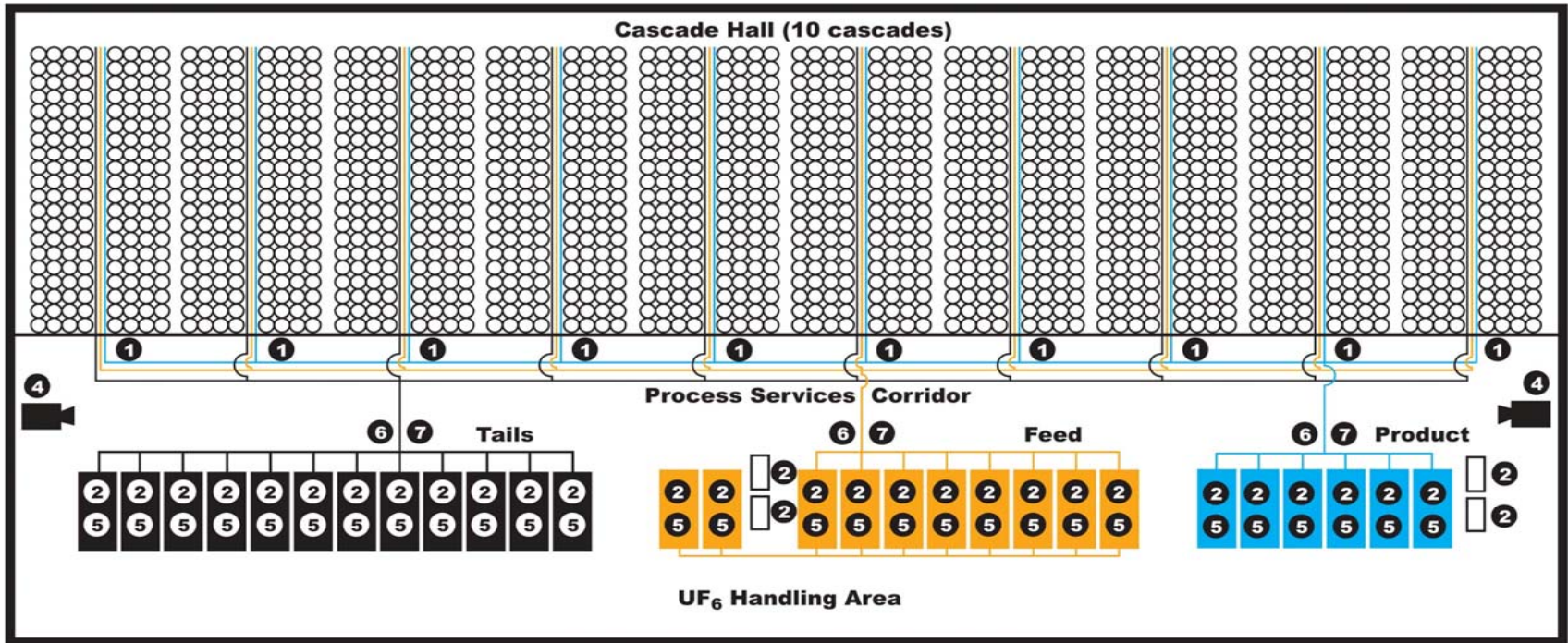

- ① Radiation Attributes Monitor
- ② Unattended F/W Station Load Cell Monitor

- ④ Process Pipe Surveillance Camera
- ⑤ Item Tag Monitor

- ⑥ Enrichment Monitor
- ⑦ Pressure Monitor

# Approaches 3 and 4

