



May 10, 2006

10 CFR 50, Appendix I

U. S. Nuclear Regulatory Commission
ATTN: Document Control Desk
Washington, DC 20555-0001

Palisades Nuclear Plant
Docket 50-255
License No. DPR-20

2005 Radiological Environmental Operating Report

Nuclear Management Company, LLC, is submitting the attached Radiological Environmental Operating Report for the Palisades Nuclear Plant. This report was prepared in accordance with the requirements of 10 CFR 50, Appendix I, Sections IV.B.2, IV.B.3, IV.C, and Technical Specification 5.6.2. The period covered by the enclosed report is January 1, 2005 through December 31, 2005.

Summary of Commitments

This letter contains no new commitments and no revisions to existing commitments.

Paul A Harden
Site Vice President, Palisades Nuclear Plant
Nuclear Management Company, LLC

Enclosure (1)
Attachments (6)

CC Administrator, Region III, USNRC
Project Manager, Palisades Nuclear Plant, USNRC
Resident Inspector, Palisades Nuclear Plant, USNRC

ENCLOSURE 1

ANNUAL RADIOLOGICAL ENVIRONMENTAL OPERATING REPORT JANUARY 1 THROUGH DECEMBER 31, 2005

TABLE OF CONTENTS

I.	INTRODUCTION	1
II.	NON-ROUTINE REPORTS	1
III.	DISCUSSION AND INTERPRETATION OF RESULTS	
A.	Air Samples	2
B.	Lake Water	2
C.	Drinking Water.....	2
D.	Milk	3
E.	TLDs - Gamma Dose	3
F.	Crops	4
G.	Sediment.....	4
H.	Fish	5
I.	Broad Leaf Vegetation	5
J.	Non-Routine Samples.....	5
K.	Gaseous and Liquid Radwaste Effluent Composite Samples.	5
IV.	ASSESSMENT OF PALISADES OPERATION ENVIRONMENTAL IMPACT	6
V.	TABLES	
A.	Table 10.4-1 Sampling and Analysis Summary	7
B.	Table 10.4-2 Sample Data Summary	8
C.	Table 10.4-3 Greatest Mean Sampling Location	10
VI.	ATTACHMENTS	
A.	Sample Collection Anomalies	
B.	Palisades Land Use Census	
C.	Health Physics Procedure HP 10.10, "Palisades Radiological Environmental Program Sample Collection and Shipment"	
D.	Palisades 2005 Final Report - Radiological Environmental Monitoring Program (REMP) as provided by Environmental, Inc., Midwest Laboratory	
E.	Environmental, Inc., Midwest Laboratory, Interlaboratory Comparison Program Results	

TABLE OF CONTENTS (CONTINUED)

F. Data Graphs

1. Palisades Air Particulate (gross beta), Operational Comparison Graphs, 1968-1969 (pre-op) and 1999-2005
2. Palisades Lake Water (Ludington Control vs. Intake, South Haven Treated and Raw), 1999-2005 in gross beta trending
3. Palisades TLD (gamma) Palisades Operational Comparison Graphs, (monthly, quarterly, and annual) 1968-1969 (pre-op monthly) and 1999-2005

I. INTRODUCTION

The Nuclear Management Company, LLC (NMC) Radiological Environmental Operating Report provides a summary and data interpretation of the Palisades Nuclear Plant (PNP) Radiological Environmental Monitoring Program as conducted during the 2005 reporting period. This report was prepared in accordance with the requirements of 10 CFR 50, Appendix I, Sections IV.B.2, IV.B.3, IV.C, and Technical Specification 5.6.2.

Detailed sample station identification and location information can be found in Attachment 2 of Health Physics Procedure HP 10.10, "Palisades Radiological Environmental Program Sample Collection and Shipment." HP 10.10 is included as Attachment C. The results of all environmental samples collected are evaluated as follows:

- A. Air iodine and particulate and thermoluminescent dosimetry (TLD) data were statistically evaluated at the 95% confidence level. The data were compared against two criteria. The first criterion is the statistical difference, which indicates whether the sample results from near sites are greater than those from control sites, and whether or not the difference is significant (e.g., statistical "T-Test" of indicator vs. control results).

If the T-Test concludes that the control and indicator populations are statistically different, then the evaluation level (twice the statistical difference) is computed. This is the minimum difference in the population means for which a corresponding difference in sample means will exceed the statistical difference with 95% confidence. If the evaluation level is exceeded, then correlation of the results with effluent releases is performed.

- B. If a sufficient number of positive sample results were available (e.g., >1 control and >1 indicator) then well water, lake water, sediment, fish, and other aquatic biota samples were evaluated using data mean comparisons (e.g., T-Test) and the PNP Offsite Dose Calculation Manual (ODCM), Appendix A, reporting limits.

II. NON-ROUTINE REPORTS

Non-routine reportable events did not occur during this reporting period.

III. DISCUSSION AND INTERPRETATION OF RESULTS

A. Air Samples

There were 260 air samples collected and analyzed for gross beta and I-131. Air iodine/particulate samples are collected weekly from five air-sampling locations. Air is metered into the sampling unit at an approximate one cubic foot per minute flow rate through a Radeco 47-mm air filter (air particulate) and a HI-Q air iodine cartridge. Both filters are in-line with each other and are housed within the same filter holder. Weekly samples were sent to Environmental, Inc., Midwest Laboratory for analysis.

Statistical analysis of the airborne particulate sample data, between the four near-site indicator locations and the control location, demonstrated no statistical difference. The mean values of gross beta results for indicator and control locations were 0.028 pCi/m³, and 0.031 pCi/m³, respectively. The control station 10-GR had the highest annual mean for gross beta results at 0.031 pCi/m³. No trends in gross beta results are discernable when compared to previous years' sample results.

All I-131 activity results were below the Minimum Detectable Activity (MDA) levels.

B. Lake Water (Surface Water)

Palisades lake water inlet (indicator), South Haven Municipal Raw (indicator) and Ludington (control) lake water inlet water samples were collected daily and combined into monthly composite samples. One gallon of Palisades Lake-In (1-ST) and Ludington Lake-in (32-LP) and two gallons of South Haven Municipal Raw (25-SH) were sent to Environmental, Inc., Midwest Laboratory for analysis each month. No treatment of the water samples with preservative is required. Thirty-six monthly lake water composite samples collected from the three locations were analyzed for gross beta and tritium.

No statistical difference was found between the indicator and the control location samples. In addition, no PNP ODCM Appendix A reporting limits were exceeded.

C. Drinking Water

Water samples from South Haven Municipal Water System (25-SH Treated) (indicator), and Ludington Lake-in (32-LP) (control), were collected daily and combined into monthly composite samples. (The South Haven municipal water sample is obtained at the PNP site.) One gallon of

Ludington Lake-in and South Haven treated are sent to Environmental, Inc., Midwest Laboratory for analysis. No treatment of water samples with preservative is required. Twenty-four monthly drinking water samples were collected from the two locations and were analyzed for gross beta and tritium.

No statistical difference was found between the indicator and the control location samples. In addition, no PNP ODCM Appendix A reporting limits were exceeded.

D. Milk

Two one-gallon quantities of raw milk (grab sample) are obtained per sample location per month from dairy milk holding tanks. Each sample quantity is treated with a sodium bisulfate preservative prior to being sent to Environmental, Inc., Midwest Laboratory for analysis.

Forty-eight monthly milk samples were collected from the four dairy farms (stations 26-JH, 27-DH, 28-DC and 29-WS).

No milk analysis identified activity above the minimum detectable level, with the exception of naturally occurring potassium-40.

E. TLDs - Gamma Dose

Environmental gamma doses are measured quarterly by placement of TLDs at each designated location. Each TLD badge contains a 4-zone Calcium Sulfate (CaSO_4) wafer (the wafer includes an additional backup/reserve readout zone). Sensitivity for the multi-zone TLDs is 10 millirem, with a linear response of 0.1 millirem to 1000 rem.

The PNP gamma assessment program consists of 29 locations. There is a total of 16 inner ring TLDs, including one on-site, nine near-site and six steam generator storage facility locations. There are ten outer ring TLD locations (1.0 to 5.5 miles out) and three control TLDs (30 to 55 miles out). A 30th TLD is placed in a lead storage cave (location number 22), and is used as a control for in-transit dose monitoring and subtraction.

There were 116 TLDs collected and analyzed during 2005. The one on-site TLD location (1-ST) serves as an individual reference TLD; however, it was evaluated along with the inner ring (site boundary) TLDs in the statistical evaluation.

The TLD data evaluations were performed by comparing the inner ring TLDs (site boundary locations 1, 13-21 and 33-38), and the outer ring

TLDs (locations 2-9, 23 and 24), against the control TLD locations (10, 11, 12).

For 2005, the quarterly average gamma readings (mR) were Inner Ring – 12.0, Outer Ring – 14.1 and Control – 15.0.

The highest average dose was observed at outer ring station number 2 (5.6 miles south) with a dose of 17.2 mrem.

Statistical analysis demonstrated that inner ring vs. control TLDs were two different populations. However, the control mean was greater than the inner ring mean. There was no statistical difference between the outer ring and control populations. No trends are discernable when comparing inner ring with outer ring and control TLD results. Overall, outer ring TLD mean results are consistently higher than inner ring TLD mean results, and control station TLD mean results are slightly higher than outer ring mean results. A likely reason for the lower results seen for the site perimeter locations is that these TLDs are placed in wooded areas and thus shielded to some degree from cosmic background radiation. A comparison made between the Inner Ring TLDs for 2004 and 2005 showed no statistical differences between the two years.

F. Crops

Food crop samples are collected when available, and in season. Two principal area crops, apples and blueberries, are regularly collected. Approximately 1 kg of sample is placed in a sealable plastic bag for shipment to Environmental, Inc., Midwest Laboratory. No special treatment of the samples with a preservative is necessary.

Four crop samples were collected. Blueberries and apples were collected at indicator station 4-JS (3.5 miles SE), and at a control station located in the least prevalent wind direction, approximately 11 miles NNE.

No crop analysis identified activity above the Minimum Detectable Activity for either I-131 or gamma emitters.

G. Sediment

Sediment samples are collected semi-annually from each designated location. No treatment of the samples with a preservative is necessary prior to shipment to Environmental, Inc., Midwest Laboratory.

Three sediment samples were collected from two locations during 2005. Two sediment samples were obtained from Palisades, 30-STN (0.5 miles

north of discharge), and one sample from the Ludington Control Station (32-LP).

No sediment analysis identified activity above the Minimum Detectable Activity for gamma emitters.

H. Fish

Fish samples are collected semi-annually. Samples consist of two species of commercially and/or recreational important species near the PNP discharge area. One sample of the same species in an area not influenced by plant discharge is collected. Each one-liter quantity of fish sample is prepared for shipment to Environmental, Inc., Midwest Laboratory. Each sample is frozen for preservation.

Eight individual fish samples were collected from three locations. Four indicator samples were obtained from Palisades (1-ST discharge) and four control samples obtained; three from the Ludington Station (32-LP), and one from Lake Ontario. The same species were collected at both indicator and control locations.

Cs-137 was the only gamma emitter detected and was seen at both the indicator and control locations. The values were 0.065 ± 0.028 pCi/g and 0.035 ± 0.020 pCi/g respectively. No trends in Cs-137 are discernable when compared to previous years' sample results. The ODCM reporting limit for Cs-137 is 2000 pCi/kg (2 pCi/gm).

I. Broad Leaf Vegetation

No broad leaf vegetation samples were collected from the surrounding PNP environs during 2005. The collection of broad leaf vegetation samples serves as a backup and/or alternative sampling medium in case any milk sampling location(s) become(s) unavailable.

J. Non-Routine Samples

Non-routine samples were not collected during this reporting period.

K. Gaseous and Liquid Radwaste Effluent Composite Samples

Both the gaseous and liquid radwaste effluent composite samples are collected monthly and sent to Environmental, Inc., Midwest Laboratory for analysis. No special sample treatment with a preservative is required prior to laboratory analysis. The liquid effluent composite sample is based on a specific amount of sample collected, per total batch volume release.

For those months in which there are no liquid batch effluent releases, no sample is sent to Environmental, Inc., Midwest Laboratory. The gaseous radwaste effluent weekly composite sample results are based on analyzing weekly stack gas filters.

Although not a direct reporting component in the PNP Annual Radiological Environmental Operating Report, results of the gaseous and liquid monthly radwaste effluent composite samples are evaluated against overall environmental trending data. This evaluation is the basis for determining isotopic dispersion and deposition patterns within the surrounding environs of PNP. All gaseous and liquid effluent results are compared to the PNP ODCM, Appendix A, reporting levels. All isotopic lower limits of detection (LLDs) were met.

IV. ASSESSMENT OF PALISADES OPERATION ENVIRONMENTAL IMPACT

In reviewing the 2005 PNP radiological environmental monitoring data, and comparing it to previous operational and pre-operational data, all trending parameters continue to indicate that the operation of PNP has minimal environmental impact. Most isotopic activity is at environmental background levels. Evidence of an overall environmental isotopic buildup (attributable to plant effluents) remains negligible as well. In most instances, sample analytical results were below previously established environmental background levels.

Palisades Nuclear Plant, Van Buren County, MI Docket 50-255

Annual Radiological Environmental Operating Report

January 1, 2005 to December 31, 2005

Table HP 10.4-1

Sampling and Analysis Summary

Medium	Collection Description	Location	Number of Samples Collected	Type of Analysis	Frequency of Analysis
Air	Continuous at approximately 1 cfm	Stations 4, 5, 8, 9 and 10	260	Gross Beta, I-131	Weekly
Lake Water	Lake-in 1 gallon composite S.H. Raw 2 gallon composite	Lake Intake and South Haven Raw	24	Gross Beta, Tritium (Tritium not done on South Haven Raw)	Monthly
Lake and Drinking Water - Control	1 gallon composite	Ludington Lake-in	12	Gross Beta, Tritium, Sr-89 and Sr-90	Monthly
Drinking Water	1 gallon composite	South Haven Municipal	12	Gross Beta, Tritium	Monthly
Well Water	2 gallons grab	Three sites adjacent to Interim Steam Generator Storage Facility	9	Gross Beta, Tritium	Quarterly
Milk	2 gallons grab	W Shine, D Hessey, D Carpenter & J Hay Dairy Farms	48	Gamma isotopic, I-131 and other isotopic	Monthly
TLD	Continuous	Inner Ring, Outer Ring, Controls	116	Gamma dose	Quarterly
Food Products	Grab	J Sarno and Control	4	Gamma isotopic and I-131	At time of harvest
Sediment	Grab	Discharge 1/2 mile north of Palisades and Ludington Control	3	Gamma isotopic	Semiannually
Fish	Grab	Discharge and Control	8	Gamma isotopic	Semiannually
Broadleaf Vegetation	Grab	NA - no samples taken			

Palisades Nuclear Plant, Van Buren County, MI Docket 50-255

Annual Radiological Environmental Operating Report

January 1, 2005 to December 31, 2005

Table HP 10.4-2

Sample Data Summary

Medium or Pathway Sampled (Unit of Measure)	Type/Total Number of Analyses Performed	Lower Limit of Detection ^a (LLD)	All Indicator Locations Mean (f) ^b Range ^b	Name Distance & Direction Of Greatest Mean	Mean (f) ^b Range ^b	Control Locations Mean (f) ^b Range ^b	Number of REPORTABLE OCCURENCES
Air Particulates (pCi/m3)	I-131 260	0.03	<LLD	--	--	<LLD	0
	Gross β 260	0.01	0.028 (208/208) (0.013 - 0.062)	Grand Rapids GR-10 55 miles NNE	0.031 (52/52) (0.018 - 0.062)	0.031 (52/52) (0.018 - 0.062)	0
Lake Water (pCi/L)	Gross β 36	4.0	1.783 (24/24) (0.9 - 2.8)	South Haven SH-25 5½ miles N	1.86 (12/12) 0.9 - 2.6	1.775 (12/12) 1.1 - 2.9	0
	Tritium 36	500	298 (3/12) 241 - 397	Ludington LP-32 125 miles N	337 (1/12) 337	337 (1/12) 337	0
Drinking Water (pCi/ml)	Gross β 24	4.0	1.750 (12/12) 1.1 - 3.0	Ludington LP-32 125 miles N	1.775 (12/12) 1.1 - 2.9	1.775 (12/12) 1.1 - 2.9	0
	Tritium 24	500	285 (3/12) 245 - 322	Ludington LP-32 125 miles N	337 (1/12) 337	337 (1/12) 337	0
Milk (pCi/L)	Gamma Spec 48						
	I-131 48	1.0	<LLD	--	--	<LLD	0
	Cs-137	18.0	<LLD	--	--	<LLD	0
	Other Gamma	15.0	<LLD	--	--	<LLD	0
Inner Ring TLD (Gamma mR)	Gamma Dose 76	10.0	12.0 (64/64) 9.6 - 14.7	Kalamazoo ST-11 35 miles E	16.7 (4/4) 15.9 - 17.2	12.0 (12/12) 12.3- 17.2	0
Outer Ring (Gamma mR)	Gamma Dose 52	10.0	14.1 (40/40) 11.1 - 18.3	ST-02 5.6 miles S	17.2 (4/4) 15.1 - 18.3	15.0 (12/12) 12.3 - 17.2	0

Table HP 10.4-2
Sample Data Summary

Medium or Pathway Sampled (Unit of Measure)	Type/Total Number of Analyses Performed	Lower Limit of Detection ^a (LLD)	All Indicator Locations Mean (f) ^b Range ^b	Name Distance & Direction	Mean (f) ^b Range ^b	Control Locations Mean (f) ^b Range ^b	Number of REPORTABLE OCCURENCES
Food Products (pCi/gm wet)	I-131 4	0.06	<LLD	--	--	<LLD	0
	Gamma Spec 4	0.05 - 0.10	<LLD	--	--	<LLD	0
Sediment (pCi/gm dry)	Gamma Spec 3	0.05 to 0.18	<LLD	--	--	<LLD	0
Fish (pCi/gm wet)	Gamma Spec 8	0.10 to 0.26	0.065 (1/4) 0.065	Plant Discharge 1/2 mile N	0.065 (1/4) 0.065	0.035 (1/4) 0.035	0

a Nominal Lower Limit of Detection (LLD) as defined in table notation c of Table E-3 of the PNP ODCM

b Mean and range based on detectable measurements only. Fraction of detectable measurements at specific locations is indicated in parenthesis (f)

Table HP 10.4-3
January 1, 2005 to December 31, 2005
Greatest Mean Sampling Location

Medium or Pathway Sampled (unit of measurement)	Type of Analysis	Location	High	Low	Mean
Air (pCi/m ³)	I-131	NA	NA	NA	NA
	Gross Beta	GR-10	0.062	0.018	0.031
Lake Water (pCi/L)	Gross Beta	25-SH SHRAW	2.6	0.9	1.858
	Tritium (d)	32-LP Ludington	337	337	337
Drinking Water (pCi/L)	Gross Beta	32-LP Ludington	2.9	1.1	1.775
	Tritium	32-LP Ludington	337	337	337
Milk (pCi/L)	I-131	NA	NA	NA	NA
	Cs-137	NA	NA	NA	NA
	Other gamma	NA	NA	NA	NA
Inner Ring TLD (gamma mR)	Quarterly (e)	ST-11, KZ	17.2	15.9	16.675
Outer Ring TLD (gamma mR)	Quarterly (e)	ST-02 Outer Ring	18.3	11.1	17.175
Crops (pCi/g wet)	I-131	NA	NA	NA	NA
	Other Gamma	NA	NA	NA	NA
Sediment (pCi/gm dry)	Gamma Emitters	NA	NA	NA	NA
Fish (pCi/gm wet)	Gamma Emitters	Discharge	0.065	0.065	0.065
Broadleaf Vegetation	Gross Beta Cs-137 Other Gamma	NA - no samples taken			

ATTACHMENT A

SAMPLE COLLECTION ANOMALIES

Sample Affected	Location	Date	Problem	Evaluation
Fish	1-ST, PNP discharge	4/6/05	Required LLDs not attained	Sample not shipped to vendor in time to permit meeting the required LLD. PNP Action Request 01024272 was initiated.
Air	10-GR (Grand Rapids Control Location)	6/1/05	Required LLD not attained	Sample not shipped to vendor in time to permit meeting the ODCM required LLD. PNP Action Request 01024272 was initiated.
Air	All Environmental Locations	2005	Some Vendor Required LLDs not Attained	Sample not shipped to vendor in time to permit meeting the Vendor required LLD. PNP Action Request 01028545 was initiated.

Note: Second quarter 2005 steam generator interim storage facility well samples were not obtained. Although not an ODCM required sample, this information is included here for completeness of reporting. PNP Action Request 01024275 was initiated.

ATTACHMENT B

PALISADES LAND USE CENSUS

The attached tables contain the results of the Palisades Land Use Census conducted on August 31, 2005. Table 10.11-1 references the distance from PNP to the nearest residence, garden (greater than 500 square feet), beef/dairy cattle, and goats per meteorological sector. Table 10.11-2 identifies the locations of the nearest residence and garden; and of all beef/dairy cattle and goats within a five (5) mile radius of PNP per meteorological sector. Table 10.11-3 lists the critical receptor locations used in calculation of the offsite doses by the GASPARG computer program. No differences were identified from the 2004 Land Use Census; therefore no changes were made to the ODCM. Palisades uses the 1992-1996 meteorological data.

2005 PALISADES LAND USE CENSUS

TABLE 10.11-1

Distance to the nearest residence, garden, dairy/beef cattle and goats in each sector.

<u>SECTOR</u>	<u>RESIDENCE</u>	<u>GARDEN</u>	<u>BEEF CATTLE</u>	<u>DAIRY COW</u>	<u>GOAT</u>
NNE	1.1 mi	1.7 mi	>5 mi	>5 mi	>5mi
NE	1.2 mi	1.2 mi	>5 mi	>5 mi	>5 mi
ENE	1.3 mi	1.6 mi	4.0 mi	>5 mi	1.8 mi
E	1.0 mi	2.1 mi	>5 mi	>5 mi	3.5 mi
ESE	1.0 mi	*1.0 mi	>5 mi	>5 mi	>5 mi
SE	1.0 mi	*1.0 mi	1.9 mi	4.3 mi	1.9 mi
SSE	0.7 mi	1.6 mi	>5 mi	>5 mi	4.8 mi
S	0.5 mi	4.0 mi	>5 mi	>5 mi	4.7 mi
SSW	0.7 mi	>5.0mi	>5 mi	>5 mi	>5 mi

* Note: Garden and Farm bisected by ESE/SE boundary line.

2005 PALISADES LAND USE CENSUS

TABLE 10.11-2

Nearest Locations per Sector Within 5 Miles

<u>Sector</u>	<u>Location Description</u>	<u>Item</u>	<u>Number</u> <u>Comment</u>
NNE Ruggles Rd	State Park Manager	Residence	1
NNE 20th	0.1 mile south of Ruggles Rd SW corner of 20 th and O fire lane	Garden	1
NE Blue Star Highway	L. Swetay, Route 3, Box 133 (East side of highway)	Residence Garden	1 1
NE M-43	M-43, N side of road, between 12 th and 16 th (approximately 0.3 mile outside of the 5-mile limit)	Goats	
ENE 24th avenue	Trailer-West 24 th avenue, dead end at sand dune	Residence	1
ENE 24th	SE corner of 76 th street and 24 th avenue	Garden	1
ENE 72nd	72 nd St. 0.3 miles N of 20 th East side of road	Cattle	Beef
ENE 76th	76 th St. 0.3 miles N of 20 th East side of road	Goat	
E 77th	77 th St., dead end of 77 th St. near 28th Avenue intersection	Residence Covert Gen Co.	1
E 72nd	C. Mims, 26200 72 nd St. intersection of 72 nd & 26 Ave NW corner	Goats Garden	1
E 72nd	72 nd St. 0.2 miles N of 26 th , W side of road	Goats	
E 75th	27723 75 th , 0.1 mile N of 28 th (East side of road)	Garden	1

2005 PALISADES LAND USE CENSUS

TABLE 10.11-2

Nearest Locations per Sector Within 5 Miles

<u>Sector</u>	<u>Location Description</u>	<u>Item</u>	<u>Number</u> <u>Comment</u>
SE/ESE 28 th	77550 28 th Avenue	Residence Garden	1 1
SE 36 th	72401 36 th Avenue, 0.2 mile West from 72 nd , South side of road	Cattle Goat	Beef and Dairy
SE 76 th	SE Corner of 76 th and 30 th , east side of road	Cattle Goat	
SE 76 th	0.1 mile South of 36 th East side of road	Goat	
SSE	80119 29 th Avenue	Residence	1
SSE 77 ½	77 ½ St., 0.3 mile N of 32 nd Ave, West side of 77 ½ St.	Garden	1
SSE 376 th	376 th , North side of road, 0.3 mile East of 76 th	Goat	
S 29 th Ave	Palisades Park, 0.5 mile West of 29 th Ave and Blue Star Highway	Residence	1
S CR 376	79911 46 th Street (CR 376) at 80 th Street intersection	Goat	
S 78 th	78 th , 0.5 mile North of CR 376 west side of road	Garden	1
SSW 29 th	29 th Ave, at dead end of Palisades Park	Residence	1

2005 PALISADES LAND USE CENSUS

TABLE 10.11-3

Critical Receptor Items

<u>Distance Sector</u>	<u>Miles</u>	<u>Location/Description</u>	<u>Item</u>	<u>*X/Q (sec/m³)</u>
SSE	0.48	Site Boundary	N/A	2.13E-06
S	0.50	Residence, Palisades Park; ½ mile West of 29th Avenue and Blue Star intersection.	Residence	1.38E-06
SE	1.0	77550 28th Avenue	Garden	5.87E-07
SE	1.9	SE corner of 76 th Street and 30 th	Beef Cattle	2.32E-07
SE	4.3	72401 36th Ave.	Dairy Cow	6.83E-08
SE	1.9	SE corner of 76 th Street and 30 th	Goat	2.32E-07

*Based on Palisades 5-year composite meteorological data, 1992 -1996.

ATTACHMENT C

**HEALTH PHYSICS PROCEDURE HP 10.10
"PALISADES RADIOLOGICAL ENVIRONMENTAL PROGRAM
SAMPLE COLLECTION AND SHIPMENT"**

33 Pages Follow

Procedure No HP 10.10
Revision 9
Effective Date 7/6/05

PALISADES NUCLEAR PLANT
HEALTH PHYSICS PROCEDURE

**TITLE: PALISADES RADIOLOGICAL ENVIRONMENTAL PROGRAM
SAMPLE COLLECTION AND SHIPMENT**

Approved: JBBurnett
Procedure Sponsor

/

7/1/05
Date

New Procedure/Revision Summary:

Editorial to Revision 9

Specific Changes

**TITLE: PALISADES RADIOLOGICAL ENVIRONMENTAL PROGRAM
SAMPLE COLLECTION AND SHIPMENT**

Table of Contents

1.0	PURPOSE.....	1
2.0	REFERENCES.....	1
2.1	SOURCE DOCUMENTS.....	1
2.2	REFERENCE DOCUMENTS.....	1
3.0	PREREQUISITES.....	2
4.0	PRECAUTIONS AND LIMITATIONS.....	2
5.0	PROCEDURE.....	3
5.1	CONTROL AND OVERSIGHT OF SAMPLING FOR THE RADIOLOGICAL ENVIRONMENTAL MONITORING PROGRAM.....	3
5.2	REMP AIR SAMPLE COLLECTION.....	4
	5.2.1 Precautions.....	4
	5.2.2 Prerequisites.....	4
5.3	REMP LAKE (DRINKING) WATER SAMPLE COLLECTION - SOUTH HAVEN, MICHIGAN.....	7
	5.3.1 Prerequisites.....	7
5.4	STEAM GENERATOR STORAGE FACILITY MONITORING WELL WATER SAMPLE COLLECTION (QUARTERLY).....	8
	5.4.1 Prerequisites.....	8
5.5	REMP MILK SAMPLE COLLECTION.....	8
	5.5.1 Precautions.....	8
	5.5.2 Prerequisites.....	9
5.6	REMP AQUATIC BIOTA COLLECTION.....	9
	5.6.1 Precautions.....	9
	5.6.2 Prerequisites.....	10
5.7	REMP SEDIMENT SAMPLE COLLECTION.....	11
	5.7.1 Prerequisites.....	11
5.8	REMP FOOD PRODUCT SAMPLE COLLECTION.....	11
5.9	REMP TLD SAMPLE COLLECTION.....	12
	5.9.1 Prerequisites.....	12

TITLE: PALISADES RADIOLOGICAL ENVIRONMENTAL PROGRAM
SAMPLE COLLECTION AND SHIPMENT

Table of Contents

5.10	MISCELLANEOUS SAMPLES	13
	5.10.1 Ludington - Control Station	13
	5.10.2 Palisades Daily Samples	13
6.0	ACCEPTANCE CRITERIA.....	13
7.0	ATTACHMENTS AND RECORDS.....	14
	7.1 ATTACHMENTS	14
	7.2 RECORDS	14
8.0	SPECIAL REVIEWS	14

ATTACHMENTS

- Attachment 1, "Environmental Sample Collection Schedule"
- Attachment 2, "Sample Locations"
- Attachment 3, "Sample Identification"
- Attachment 4, "Sample Packaging and Shipment"
- Attachment 5, "Palisades Sample Collection Forms and Records"

**TITLE: PALISADES RADIOLOGICAL ENVIRONMENTAL PROGRAM
SAMPLE COLLECTION AND SHIPMENT**

USER ALERT
INFORMATION USE PROCEDURE

The activities covered by this procedure may be performed from memory.

1.0 PURPOSE

To provide methodology for collection of environmental samples in support of the Radiological Environmental Monitoring Program (REMP).

2.0 REFERENCES

2.1 SOURCE DOCUMENTS

2.1.1 Reg Guide 4.15(7)

2.1.2 10CFR50, Appendix I

2.1.3 Palisades Administrative Procedure 7.08, "Palisades Radiological Environmental Monitoring Program"

2.1.4 REMP Sample Shipping Manual, Environmental Inc

2.1.5 Health Physics Procedure HP 10.1, "Radiological Environmental Monitoring Program Surveillance"

2.1.6 Offsite Dose Calculation Manual (ODCM)

2.1.7 Branch Technical Position (Revision 1, 1979), "Radiological Portion of the Environmental Monitoring Program"

2.2 REFERENCE DOCUMENTS

2.2.1 Palisades ODCM, Appendix A, Sections III.J, IV.C, and Tables E-1 and E-2

2.2.2 Palisades Administrative Procedure 10.46, "Plant Records"

2.2.3 Palisades Administrative Procedure 10.41, "Procedure and Policy Processes"

2.2.4 Health Physics Procedure HP 6.52, "Palisades (Onsite) Radiological Environmental Program Sample Collection"

2.2.5 Palisades Administrative Procedure 3.19, "Technical Specifications Programs" |

**TITLE: PALISADES RADIOLOGICAL ENVIRONMENTAL PROGRAM
SAMPLE COLLECTION AND SHIPMENT**

3.0 PREREQUISITES

As indicated in procedure.

4.0 PRECAUTIONS AND LIMITATIONS

- 4.1 This procedure shall be applicable to Palisades/Chemistry & Radiation Protection, Environmental Department, and any contractual personnel assigned to collect or evaluate REMP samples.
- 4.2 Any revisions to this procedure shall be reviewed against Palisades ODCM Specifications to verify compliance to all requirements.
- 4.3 Deviations from the required sampling schedule shall be documented in the Annual Radiological Environmental Operating Report.
- 4.4 Every effort shall be made to complete corrective action on malfunctioning sampling equipment prior to the end of the next sampling period.
- 4.5 If it is not possible to obtain the required samples, suitable alternative media and locations shall be substituted within 30 days.
- 4.6 Samples shall be collected, prepared, and shipped for analysis in a timely manner to preserve integrity. Other specific handling precautions for sample media are indicated in Section 5.0 as required.
- 4.7 Obtain best available replacement sample for any missing sample. Some samples are not replaceable (TLDs, air samples, etc), however, water, milk, crop samples, etc, should be.
- 4.8 Document any missing samples or malfunctioning equipment on sample data collection sheets.

**TITLE: PALISADES RADIOLOGICAL ENVIRONMENTAL PROGRAM
SAMPLE COLLECTION AND SHIPMENT**

5.0 PROCEDURE

USER ALERT
INFORMATION USE PROCEDURE

The activities covered by this procedure may be performed from memory.

5.1 CONTROL AND OVERSIGHT OF SAMPLING FOR THE RADIOLOGICAL ENVIRONMENTAL MONITORING PROGRAM

5.1.1 Sampling techniques described by this procedure must be strictly adhered with.

- a. This includes use of tweezers for air sample media change out to ensure the collected media is not disturbed.
- b. Recorded data should be verified including verification of transcribed data to avoid errors.
- c. All deviations from performance requirements, unavailable samples, or other sampling anomalies must be reported to the C&RP Radiological Environmental Contact.

5.1.2 Failure of sample collectors to comply with sampling and reporting requirements may result in remedial training, or reassignment of sampling duties.

5.1.3 The C&RP Radiological Environmental Contact shall conduct periodic (annual) audits of air sampling activities performed by non-Palisades C&RP personnel.

- a. These audits shall include observation of collection techniques, verification of procedural compliance, and review of equipment condition.

Included in the review of equipment condition, is to ensure that any fast growing trees and bushes in the vicinity of the station are removed, along with any branches extending over the top of the sampler. The goal is to keep every station away from the drip line (with the exception of station 9, which has an existing canopy 50 feet above the station).

- b. Audits should specifically address air sample collection and should include observation of all individuals involved in sample changeout.

TITLE: PALISADES RADIOLOGICAL ENVIRONMENTAL PROGRAM
SAMPLE COLLECTION AND SHIPMENT

- c. Results of the audits and any follow up action should be documented in the REMP file.

Collect samples using the following methodology in accordance with schedule and location data described in Attachments 1 and 2.

5.2 REMP AIR SAMPLE COLLECTION

5.2.1 Precautions

- a. New filters and cartridges should be transported and handled such that potential contamination of them is minimized (ie, placed in clean plastic bags, etc).
- b. If an air sampling unit is discovered not operating, attempt to find the cause and repair. If this cannot be done, replace applicable component and document on air sample collection data sheet.
- c. Airflow meters shall be calibrated annually by General Meter. All in service calibrated meters will have affixed a valid calibration sticker/card stating date of calibration and calibration due date.
- d. Airflow meters shall be changed out prior to the expiration of calibration dates.
- e. Air station leakage shall be none detectable. If the replacement of air station components is required due to air leakage, document on air sample collection data sheet.

5.2.2 Prerequisites

- a. Glass fiber (particulate) air filters
- b. Charcoal cartridges for iodine sampling (prelabeled for each air sampler)
- c. Glassine or plastic envelopes (prelabeled for each air sampler)
- d. REMP Air Sample Data Sheet (containing installation data)
- e. Replacement air sample meters (as required)
- f. Tweezers

TITLE: PALISADES RADIOLOGICAL ENVIRONMENTAL PROGRAM
SAMPLE COLLECTION AND SHIPMENT

- g. Stop Watch
- h. Step Ladder

NOTE: The Control Station 10-GR, is changed out weekly by an independent collector, and mailed in separately. The prelabeling of cartridges and envelopes, detailed below, is not required for this station as sample mix-up is not possible. In addition, for control station, the Palisades Sample Collection Form and Records (Page 1 of Attachment 5) is completed by the Technician changing out the four local stations by transferring the recorded data provided by the independent collector.

5.2.3 Perform the following weekly at each sample location:

- a. Open the protective cover on the air sample station and verify the sampling location number written on the inside of the door is the same as the prelabeled sample change-out package.
- b. Verify that the meter serial number and calibration due date are correctly documented on Palisades Plant Environmental Monitor Operability Check and Sample Collection data form (Page 1 of Attachment 5).
- c. Determine and record the "As Found Flow" rate (seconds for one cubic foot of volume).
- d. Determine and record the "As Found Leak" rate by placing hand over filter housing inlet to form a seal. While holding hand over the inlet, determine if air leakage is evident by checking the air flow meter needle for movement (leakage). If no air leakage, record (N) in the "As Found Leak" column. If air leakage is indicated, determine the cause and repair as soon as possible.
- e. Unplug or turn off the air pump and record the "REMOVED MONTH/DAY/YEAR," "REMOVED TIME," and "GAS METER READING REMOVED."
- f. Remove the prelabeled charcoal cartridge and place in zip lock bag.
- g. Using tweezers, carefully remove particulate filter from the sampler head and place in the prelabeled glassine envelope or plastic envelope.
- h. Clean out any residue or moisture buildup in sampler head before replacement filter is installed. Check the condition of the sampler head o-rings. Replace cracked o-rings as necessary to prevent air leakage.

TITLE: PALISADES RADIOLOGICAL ENVIRONMENTAL PROGRAM
SAMPLE COLLECTION AND SHIPMENT

- i. Install new particulate filter and charcoal cartridge and ensure that both are properly centered in sampler head to prevent air leakage. Ensure the fiber side of the particulate filter is facing out (smooth side facing inward).
- j. Restart air pump. Place hand over the filter housing inlet to form a seal, determine if air leakage is evident by checking air flow meter needle movement. If no air leakage, record (N) in the "As Left Leak" column. If air leakage indicated, determine the cause of the leakage (filter not centered in holder properly or cracked o-ring) and correct problem as soon as possible, restoring system to no air leakage.
- k. Determine and record "As Left" flow rate. If greater than 90 seconds are required for one cubic foot of volume, the sample pump is degrading. Replace pump as soon as possible to avoid failure to reach minimum sample volume. (5000 ft³).
- l. If an airflow meter must be replaced, record this in the "Comments" column. Record replacement meter data in the reading on the upcoming week's sample collection data sheet.
- m. Close the protective cover on the air sample station.
- n. Proceed to the next station. Date and sign the current week's data sheet upon completion of the entry of all current data.
- o. Calculate and record "SAMPLE VOL (FT3)," ALSO ensure all pertinent data is recorded.
- p. Transcribe the "REMOVED MONTH/DAY/YR" and "GAS METER READING REMOVED" taken in Step 5.2.3e to the "INSTALLED" reading columns on the sample collection sheet to be used for the upcoming week's air sample collection. Also transcribe the meter serial number and calibration due date to the upcoming week's sample collection sheet.

**TITLE: PALISADES RADIOLOGICAL ENVIRONMENTAL PROGRAM
SAMPLE COLLECTION AND SHIPMENT**

**5.3 REMP LAKE (DRINKING) WATER SAMPLE COLLECTION -
SOUTH HAVEN, MICHIGAN**

5.3.1 Prerequisites

- a. Two clean, one-gallon plastic containers labeled with sample type, location, amount, and date (or collection period)
- b. Data Sheet (Attachment 3)

5.3.2 Perform the following sample collection monthly:

- a. Leave two containers with the plant personnel at the South Haven Municipal Water Treatment Plant. New water sample containers should be left at the South Haven Water Treatment Plant upon pickup of end-of-month composite samples.
- b. Instruct the plant personnel to add approximately 300 ml per day of raw water to containers labeled "RAW."
- c. Return at end of month to collect containers. Obtain verbal verification that Step 5.3.2b was carried out. Note any deviations in "Remarks" column of data sheet.
- d. Label containers with sample type, location, and collection period.
- e. Package and ship samples per Attachment 4.
- f. Record location, sample types, and amount on sample identification data sheet (Attachment 3).

TITLE: PALISADES RADIOLOGICAL ENVIRONMENTAL PROGRAM
SAMPLE COLLECTION AND SHIPMENT

**5.4 STEAM GENERATOR STORAGE FACILITY MONITORING WELL WATER
SAMPLE COLLECTION (QUARTERLY)**

5.4.1 Prerequisites

- a. Clean, one-gallon plastic containers
- b. Data Sheet (Attachment 3)

5.4.2 Perform the following sample collection quarterly:

- a. Begin pumping water, and allow water to run for approximately one minute to purge the lines.
- b. Fill two clean, one-gallon plastic containers with well water from each sample location.
- c. Label containers with sample type, location, and collection date.
- d. Package and ship samples per Attachment 4.
- e. Record on data sheet location, type, date, amount, and under "Remarks" any pertinent information.

5.5 REMP MILK SAMPLE COLLECTION

5.5.1 Precautions

- a. Milk samples shall be sent to the laboratory as soon as possible because of the short half-life of I-131. Any undue delay may cause ODCM, Appendix A, Table E-3 analytical LLD requirements to be violated.
- b. Obtain best available replacement sample for any missing milk sample(s). Identify new sample location(s) and update location in Attachment 2.
- c. If milk samples are unavailable, then samples of three different kinds of broad leaf vegetation grown nearest to Palisades in each of two different offsite locations of the highest predicted average ground level D/Q (SE or SSE sectors near site), and one sample of each kind of similar broad leaf vegetation grown 15-30 km distant from Palisades in the least prevalent wind direction (NNE, NE or ENE sectors) may be used as replacement samples. The new sample locations shall be identified and the REMP procedures revised within 30 days to reflect sampling changes. Collect approximately one kilogram (2.2 lb) of each sample type.

TITLE: PALISADES RADIOLOGICAL ENVIRONMENTAL PROGRAM
SAMPLE COLLECTION AND SHIPMENT

5.5.2 Prerequisites

- a. Two clean, plastic one-gallon containers for each sample location
- b. Sodium bisulfite preservative (approximately 40 gm per gallon of milk required)
- c. Data Sheet (Attachment 3)

5.5.3 Perform the following monthly at each specified sample collection location:

- a. Obtain two one-gallon grab samples of raw milk as specified in Attachments 1 and 2.
- b. Add approximately 40 gm of sodium bisulfite to each one-gallon container of milk and thoroughly mix. The sodium bisulfite can either be in prepared packets or "scooped" with a volumetric measure from its container.
- c. Label containers with sample type, location, and date.
- d. Package and ship samples as per Attachment 4.
- e. Record on Sample Data Sheet, the location, type, date, and amount of samples. Under "Remarks," note any other pertinent information.

5.6 REMP AQUATIC BIOTA COLLECTION

5.6.1 Precautions

- a. Collection to be coordinated between Radiological Services Department responsible Section and the Environmental Department. At least one individual in the collection party is required to have Michigan Department of Environmental Quality (MDEQ) Cultural and Scientific Fish Collectors Permit if gill net is used.
- b. If logistical problems prevent use of a boat to set gill nets from the lake side of Palisades, then the nets can be set offshore from the site boundary (by wading). Notify Security prior to using offshore wading method for beach access.

TITLE: PALISADES RADIOLOGICAL ENVIRONMENTAL PROGRAM
SAMPLE COLLECTION AND SHIPMENT

5.6.2 Prerequisites

- a. Boat with required safety equipment, or waders
- b. Gill nets with weights and floats
- c. Plastic one-liter wide-mouth bottles
- d. Data Sheet (Attachment 3)
- e. Fillet knives
- f. Black permanent felt markers for sample identification on containers
- g. Notify district MDEQ Fisheries biologist prior to sample collection

5.6.3 Collect samples twice during the season of greatest abundance (typically May through October) as follows:

- a. Gill nets are placed at the locations specified in Attachment 1 to collect at least two species of commercially and/or recreationally important fish in the vicinity of the Plant discharge area and the same species in an area not influenced by the Plant discharge (Ludington Pump Storage Plant or other Consumers Energy facility). One liter of flesh should be collected for each species caught for analysis accuracy.
- b. Normally fish will be collected first from the vicinity of the discharge. REMP coordinator will then collect at least two of the same species at Ludington (control station). Or REMP coordinator will provide the Ludington collector with a list of the species collected in the vicinity of the discharge, with instructions to collect at least two of the same species.
- c. Label all containers with sample type, location, and date.
- d. Package and ship samples per Attachment 4.
- e. Record on data sheet location, type, date, amount, and under "Remarks" indicate any pertinent information.

**TITLE: PALISADES RADIOLOGICAL ENVIRONMENTAL PROGRAM
SAMPLE COLLECTION AND SHIPMENT**

5.7 REMP SEDIMENT SAMPLE COLLECTION

5.7.1 Prerequisites

- a. One-liter, wide-mouth plastic sample bottles
- b. Data Sheet (Attachment 3)

5.7.2 Collect sediment samples semiannually at station 30, 0.5 miles north of discharge, and a control sample at the Ludington Pump Storage Plant.

- a. Label containers with sample type, location, and date.
- b. Package and ship samples per Attachment 4.
- c. Record on Sample Data Sheet location, type, date, and amount of sample. Note any other pertinent information in the "Remarks" section.

5.8 REMP FOOD PRODUCT SAMPLE COLLECTION

- a. Sample containers
- b. Data Sheet (Attachment 3)

5.8.1 Collect food samples monthly during the harvest season, as per ODCM, Appendix A, Table E-1. One sample each of the two principal fruit crops blueberries and apples must be collected.

- a. Collect approximately one kilogram (2.2 lb) of each sample type. Samples are not to be washed, shaken, or cleaned. Samples should not be collected from a single source, but at random from the entire orchard or field.
- b. Label all containers with sample type, location, and date.
- c. Package and ship samples per Attachment 4.
- d. Record on data sheet location, type, date, amount, and under "Remarks" note any unusual conditions.

**TITLE: PALISADES RADIOLOGICAL ENVIRONMENTAL PROGRAM
SAMPLE COLLECTION AND SHIPMENT**

5.9 REMP TLD SAMPLE COLLECTION

5.9.1 Prerequisites

- a. TLDs
- b. TLD Data Sheet (Attachment 5)

5.9.2 Quarterly at each sample location perform the following:

- a. Upon receipt of TLDs from the laboratory contractor, all TLDs shall be inventoried and immediately placed in the lead cave. Note date of receipt and inventory on TLD data sheet.
- b. Field TLDs shall only be removed from the lead cave for delivery to their proper locations. All control TLDs remain in the lead cave throughout the entire exposure period.
- c. Remove and replace TLDs at each sample location.
- d. For any missing TLDs, perform the following:
 - 1. Search immediate area.
 - 2. If lost TLD is found, collect it and perform standard change out procedure.
 - 3. If lost TLD is not found, post the new TLD in proper location.
 - 4. Record in "Remarks" column of data sheet any of the above circumstances.
- e. Store collected field TLDs in lead cave along with control TLDs until ready for mailing to laboratory contractor. Mark "Do not x-ray" on TLD package.
- f. Transportation control TLDs (Shield TLDs) are to be stored in a special lead shield provided by laboratory contractor after the field TLDs are posted.

Ensure that designated transportation control TLDs are included with the correct TLD package being mailed to laboratory contractor. Also ensure that laboratory contractor's TLD data sheet is completed and enclosed with shipment.

TITLE: PALISADES RADIOLOGICAL ENVIRONMENTAL PROGRAM
SAMPLE COLLECTION AND SHIPMENT

- g. Record TLD collection date and the date that the TLDs are returned to the vendor. Initial/sign the data sheet (Attachment 5). Record the installation date for the new TLDs on the appropriate data sheet.
- h. Package and ship samples per Attachment 4.

5.10 MISCELLANEOUS SAMPLES

5.10.1 Ludington - Control Station

NOTE: Sediment samples are also collected at Ludington Pump Storage Plant per Section 5.7 of this procedure.

- a. Ludington Lake In composites are collected daily and shipped to Palisades on a monthly basis.
- b. Palisades RETS/REMP personnel record appropriate data on the Sample Data Sheet for shipment to Environmental Inc.

5.10.2 Palisades Daily Samples

- a. Palisades Lake In, Lake Out, Site Water, Service Water, and Turbine Sump effluent samples are collected on a daily basis per Palisades per Health Physics Procedure HP 6.52, "Palisades (Onsite) Radiological Environmental Program Sample Collection."
- b. Palisades RETS/REMP personnel record appropriate data on the Sample Data Sheet and label all samples.

6.0 ACCEPTANCE CRITERIA

Proper completion of procedure.

**TITLE: PALISADES RADIOLOGICAL ENVIRONMENTAL PROGRAM
SAMPLE COLLECTION AND SHIPMENT**

7.0 ATTACHMENTS AND RECORDS

7.1 ATTACHMENTS

7.1.1 Attachment 1, "Environmental Sample Collection Schedule"

7.1.2 Attachment 2, "Sample Locations"

7.1.3 Attachment 3, "Sample Identification"

7.1.4 Attachment 4, "Sample Packaging and Shipment"

7.1.5 Attachment 5, "Palisades Sample Collection Forms and Records"

7.2 RECORDS

7.2.1 Distribution of Sample Collection Data Sheet as per Attachment 4.

7.2.2 All Radiological Environmental Monitoring Program Records shall be considered complete when the Annual Radiological Environmental Operating Report is submitted to the NRC. Records shall be retained in accordance with Palisades Administrative Procedure 10.46, "Plant Records."

8.0 SPECIAL REVIEWS

The scope of this procedure includes activities that require a PRC Review per Palisades Administrative Procedure 3.19, "Technical Specifications Programs," but do not require a 50.59 Review per Palisades Administrative Procedure 10.41, "Procedure and Policy Processes." Therefore, changes to this procedure require a PRC Review but do not require a 50.59 Review.

ENVIRONMENTAL SAMPLE COLLECTION SCHEDULEProc No HP 10.10
Attachment 1
Revision 9
Page 1 of 2**Palisades Nuclear Plant**

<u>Exposure Pathway and/or Sample</u>	<u>Number of Samples and Locations*</u>	<u>Sample Type</u>	<u>Collection Frequency</u>
Airborne: Particulates	4 – Within a 10 km - Radius 1 - 25 to 89 km Distant	Continuous at approximately 1 cfm (may be less due to dust loading)	Weekly
Iodines	Same as Particulates	Same as particulates	Weekly
Waterborne: Lake Water	1 – Intake 1 - Intake (Ludington Control)	Daily composite to obtain a one-gallon sample	Monthly
Drinking Water	1 - S Haven Municipal System - Raw 1 – Domestic Water		
Well Water	**3 - Plant Site Locations	Two-gallon grab sample	Quarterly
Sediment	1 - 0.8 km North of discharge 1 - Ludington control	One-liter grab sample	Semiannually

**These are monitoring wells of the groundwater for the Steam Generator Storage Facility, this is not part of the environmental sampling program.

*If samples are unavailable at the specified location, an attempt should be made to sample at an alternate location (refer to Step 4.5).

ENVIRONMENTAL SAMPLE COLLECTION SCHEDULE

Proc No HP 10.10
Attachment 1
Revision 9
Page 2 of 2

Palisades Nuclear Plant

<u>Exposure Pathway and/or Sample</u>	<u>Number of Samples and Locations*</u>	<u>Sample Type</u>	<u>Collection Frequency</u>
---	---	--------------------	---------------------------------

NOTE: Currently there are no dairy farms within a distance of 5 to 8 km from the Plant. However, milk samples will be obtained at 3 locations within a distance of 15 km when available. When milk samples are collected, broad leaf vegetation sampling is not required.

Ingestion: Milk	3 - From 5 to 8 km 1 - Control from 15 to 30 km	Two-gallon grab sample	Monthly
Food Products	1 - Each of two principal fruit crops (blueberries and apples).	Two-pound grab sample	At time of harvest
Fish	2 - Location in vicinity of Plant discharge 2 - Ludington control or other CMS Energy facility	One-liter fish flesh from each available species, two species required. Obtain the same species from the control location.	Twice in season
Direct: TLD	1 -Onsite 16 - Site boundary 9 -Within 12 km radius 3 -Control stations 1 -Control in lead cave	Continuous	Quarterly

*If samples are unavailable at the specified location, an attempt should be made to sample at an alternate location (refer to Step 4.5).

SAMPLE LOCATIONS
Palisades Nuclear Plant

Station	Code	Location	Air Particulates	Air Iodine	Lake Water	Well Water	Milk	Food Products	Sediment	TLD	Fish
*1	ST	Palisades Nuclear Plant	Onsite, on tree near nw corner of bag crew bldg.			X				X	X
2	TH	RR 3 Coloma, MI 5.6 miles S	TLD located on 80th Street, west side on post, 200 feet south of the old air sample station.							X	
3	HS	76182 48th Ave Covert, MI 5.8 miles SSE	Along 48th Ave, 1/4 mile west of 76th St. in barmyard 50 yds off north side of road.							X	
4	JS	36197 M-140 Hwy Covert, MI 3-1/2 miles SE	Along 36th Ave, 1/2 mile east of M-140 15 ft off south side of road. TLD located in front yard of residence.	X	X			X		X	
5	PR	72723 CR 378 Covert, MI 3-1/2 miles ESE	Along CR 378, 3/4 mile east of M-140, 30 ft off north side of road. TLD located at Paul Rood residence, on tree in back yard just past driveway.	X	X					X	
6	RB	RR 3 South Haven, MI 4-1/2 miles NE	Along 12th Ave (CR 384), turn nw past maple grove, go 1/4 mile located in orchard on north side of road.							X	
7a	SN21	Emergency Siren 21 4.1 miles NNE	On Monroe Blvd, at corner of 11th Street.							X	
8	SP	State Park 1 mile N	Onsite along the dump road, north of Plant. One mile from main gate. Near State Park boundary, on side of road as road turns west.	X	X					X	
9	TP	Covert Township Park 1.5 miles SSW	Along 32nd Ave, 1/4 mile west of Blue Star Hwy. 5 ft off south side of road. TLD located at end of road, at entrance to HSarno residence, attached to emergency siren SN38.	X	X					X	
10	GR	Grand Rapids, MI 55 miles NNE	Grand Rapids Service Center, in storage area. Air sample on west side near shed. Control TLD 100 feet north of air sample station.	X	X					X	

SAMPLE LOCATIONS
 Palisades Nuclear Plant

Station	Code	Location	Air Particulates	Air Iodine	Lake Water	Well Water	Milk	Food Products	Sediment	TLD	Fish
34	ST	Perimeter of Palisades NE								X	
35	ST	Perimeter of Palisades ENE								X	
36	ST	Perimeter of Palisades ENE								X	
37	ST	Perimeter of Palisades E								X	
38	ST	Perimeter of Palisades SE								X	
41	ST	Plant Site Monitoring Well #14				X					
42	ST	Plant Site Monitoring Well #15				X					
43	ST	Plant Site Monitoring Well #16				X					
44	CN	Control Station NNE						X			

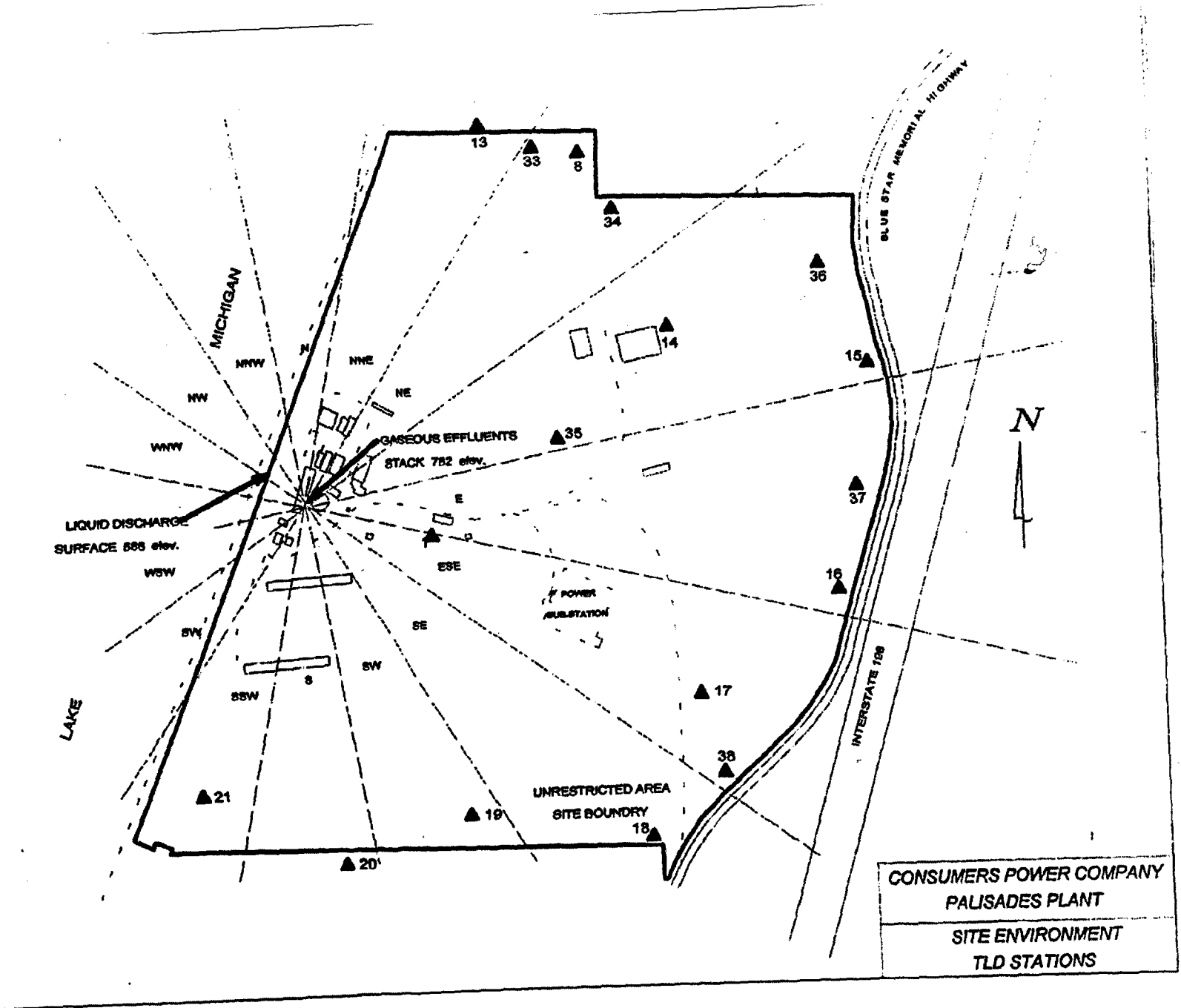

SAMPLE LOCATIONS
Palisades Nuclear Plant

SAMPLE LOCATIONS
Palisades Nuclear Plant

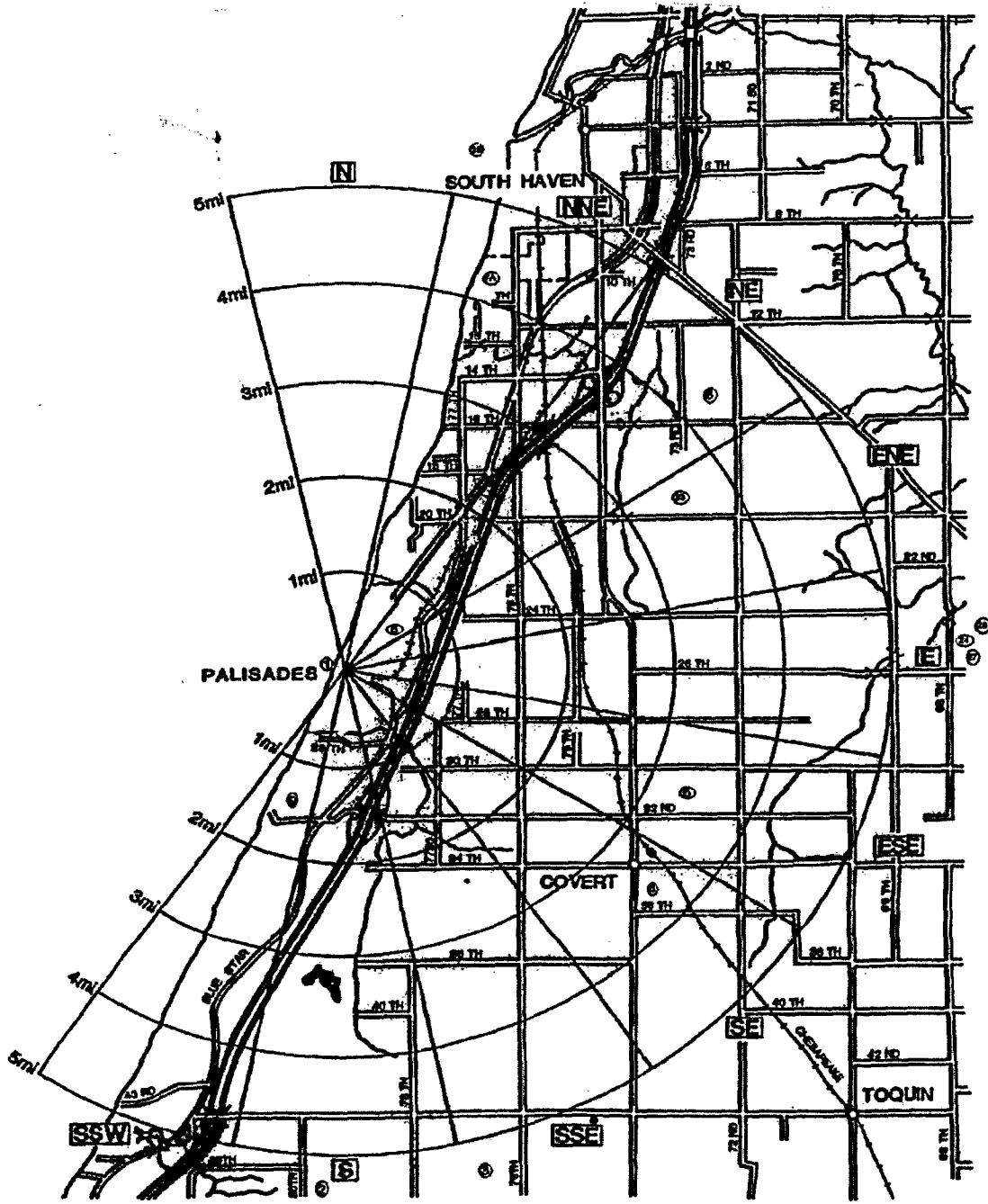

NOT SHOWN (Control Locations)

- 10 Grand Rapids (55 mi NNE)
- 11 Kalamazoo (35 mi E)
- 12 Dowagiac (30 mi SSE)
- 22 Control TLD placed in lead cave off site
- 26 Joe Hay (JH - 11.4 mi ESE)

SAMPLE LOCATIONS
Palisades Nuclear Plant

Proc No HP 10.10
Attachment 2
Revision 9
Page 7 of 9

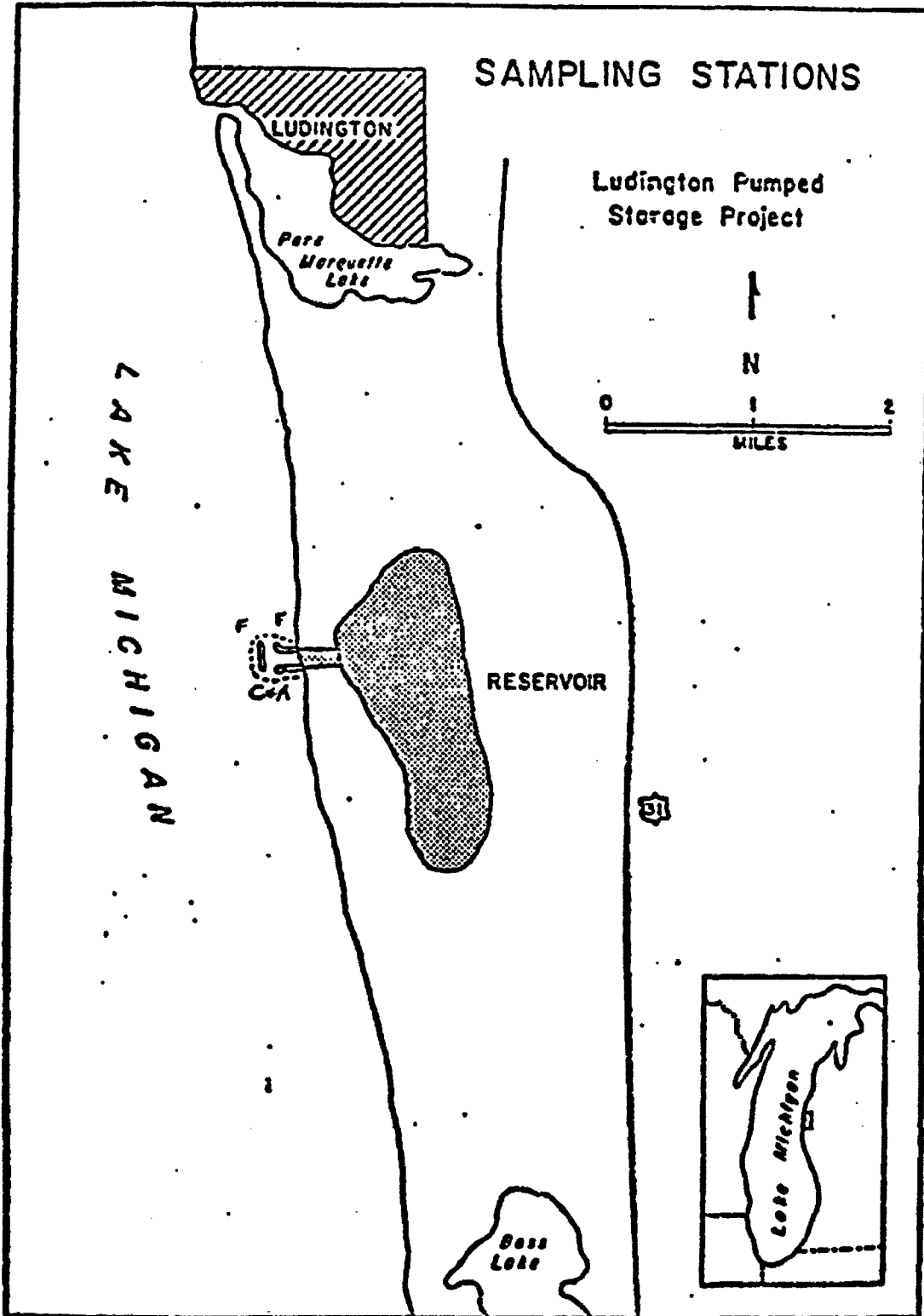

SAMPLE LOCATIONS
Palisades Nuclear Plant

<u>REMP SAMPLING</u>	<u>NUMBER</u>	<u>WELL STATUS</u>	<u>LOCATION</u>
NO	#1	Abandon	NA
NO	#2	Abandon	North side of Support Building. Supports Plant site.
NO	#3	Abandon	Across from East-Radwaste (South Side) backup for well #2.
NO	#4	Abandon	NA
NO	#5	Abandon	NA
NO	#6	Active	Located ~ 145 ft west of Blue Star Hwy. Used for training trailers, well capped when not in service and well is outside of Westerly Groundwater Flow to Plant and interim storage facility.
NO	#7	Abandon	Just to the west & between outage building and interim storage facility: Water is nonpotable and used in warehouse restrooms (later to be used for fire system only).
NO	#8	Abandon	NA
NO	#9	Abandon	Located at junction of access and warehouse road, domestic water supply for warehouse when it is put in service.
NO	#10	Abandon	NA
NO	#11	Abandon	North of access road and east of construction road, supplies domestic water for outage building, all in one tie-in.
	#12	Abandon	
	#13	Abandon	
YES	#14	Active	East of Interim Storage Facility, used for REMP monitoring well.
YES	#15	Active	Southwest of Interim Storage Facility, used for REMP monitoring well.
YES	#16	Active	Northwest of Interim Storage Facility, used for REMP monitoring well.

SAMPLE LOCATIONS
Palisades Nuclear Plant

Proc No HP 10.10
Attachment 2
Revision 9
Page 9 of 9

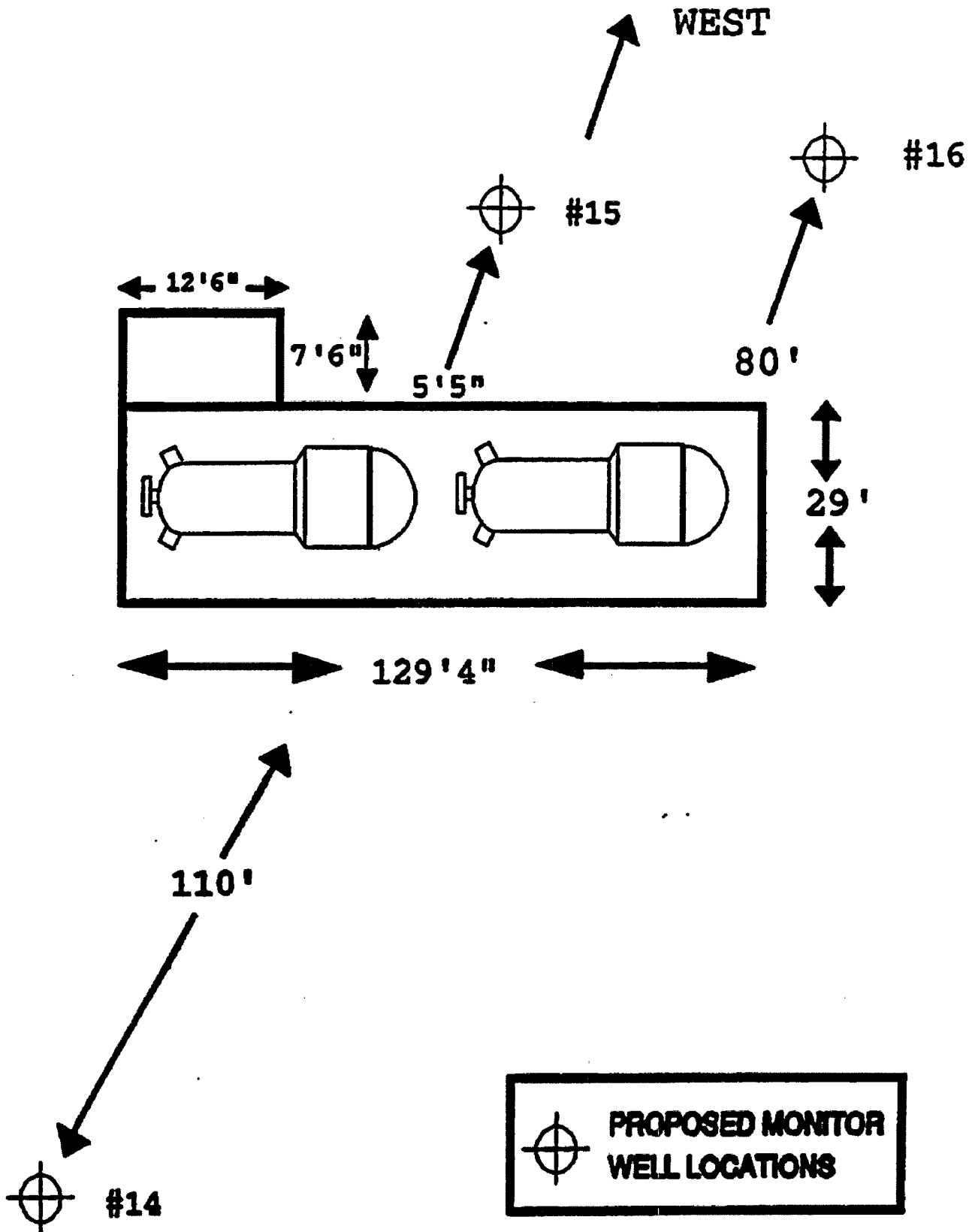

SAMPLE IDENTIFICATION

PALISADES PLANT

Miscellaneous Radiological Environmental Samples

Date Shipped: _____

Location	Type	Date	Time	Amount	Remarks
Allen Karr	Milk			2 Gallons	
Danny Carpenter	Milk			2 Gallons	
Dennis Hessey	Milk			2 Gallons	
William Shine	Milk			2 Gallons	
South Haven	Raw Water	Monthly Composite -	NA	2 Gallons	
Site #14	Well Water			2 Gallons	
Site #15	Well Water			2 Gallons	
Site #16	Well Water			2 Gallons	
Lake In	Plant Water	Monthly Composite -	NA	1 Gallon	
Service Water	Plant Water	Monthly Composite -	NA	1 Gallon	
Plant Drinking Water	Plant Water	Monthly Composite -	NA	1 Gallon	
Ludington Lake	Control Sample	Monthly Composite -	NA	1 Gallon	

SAMPLE PACKAGING AND SHIPMENT

1. Label samples clearly per Attachment 3.
2. Seal all liquid, biota, fish, and sediment sample containers with tape to prevent leakage.
3. Ship liquid samples separately from air particulate and air iodine samples and TLDs.
4. Use sufficient packing material (ie, crumpled newspaper) to avoid possible sample container damage during shipment.
5. Package air filters in glassine or plastic envelopes.
6. For TLD shipments, make sure that laboratory contractor's own TLD data sheet is enclosed with package.
7. Ship milk samples as soon as possible. Be sure to add a sufficient amount of sodium bisulfite (40 grams) as preservative to each sample.
8. Ship food products as soon as possible after collection.
9. Ship fish frozen or packed in ice, or with a 10% formaldehyde solution added (preservative). Only 10 milliliters is required per sample. Samples should be shipped as soon as possible after processing.
10. Distribute copies of the Sample Collection Data Sheet(s) to the:

Analytical Laboratory
Radiological Services Department Environmental Contact (Palisades)
11. Send samples to the following address:

Environmental Inc.
Att: Laboratory Manager
700 Landwehr Road
Northbrook, IL 60062
12. Ship all samples to the laboratory contractor with minimal delay after collection so as to avoid elevated analytical levels of detection.

PALISADES SAMPLE COLLECTION FORMS AND RECORDS

PALISADES PLANT
 ENVIRONMENTAL MONITOR OPERABILITY CHECK
 AND SAMPLE COLLECTION

			REMOVED TIME	GAS METER READING		METER SERIAL NO CAL DUE DATE	FLOW TEST				REPLACEMENT METER		SAMPLE VOL (Ft ³)	COMMENTS
	INSTALLED (MO/DA/YR)	REMOVED (MO/DA/YR)		INSTALLED (Ft ³)	REMOVED (Ft ³)		AS FOUND		AS LEFT		SERIAL NUMBER	CALIB ACCURACY ACCEPTABLE		
							FLOW (SEC/Ft ³)	LEAK (Y/N)	FLOW (SEC/Ft ³)	LEAK (Y/N)				
4JS														
5PR														
8SP														
9TP														
10GR														

TEST PERFORMED BY: _____ DATE: _____

REVIEWED BY: _____ DATE: _____

**PALISADES SAMPLE COLLECTION FORMS
AND RECORDS**

Proc No HP 10.10
Attachment 5
Revision 9
Page 2 of 2

CONSUMERS ENERGY
PALISADES ENVIRONMENTAL TLD REPORT

QUARTERLY

Collector _____

STATION - LOCATION	INSTALLED		COLLECTED		REMARKS
	DATE	TIME	DATE	TIME	
C-1					
C-2					
ST1	ST				
ST2	TH				
ST3	HS				
ST4	JS				
ST5	PR				
ST6	RB				
ST7a	SN21				
ST8	SP				
ST9	TP				
ST10	GR				
ST11	KZ				
ST12	DG				
ST13	ST				
ST14	ST				
ST15	ST				
ST16	ST				
ST17	ST				
ST18	ST				
ST19	ST				
ST20	ST				
ST21	ST				
ST22	CVS				
ST23	SN19R				
ST24	SN26				
ST-33	ST				
ST-34	ST				
ST-35	ST				
ST-36	ST				
ST-37	ST				
ST-38	ST				
SH-1, SH-2	SH				
Date Received From Vendor (With Intransit TLDs) and Initials		Date TLDs Inventoried and Placed in Lead Cave (With Intransit TLDs) and Initials		Date TLDs Returned to Vendor For Analysis (With Intransit TLDs) and Initials	

ATTACHMENT D

**PALISADES FINAL REPORT
RADIOLOGICAL ENVIRONMENTAL MONITORING PROGRAM (REMP)
AS PROVIDED BY ENVIRONMENTAL, INC, MIDWEST LABORATORY**

31 Pages Follow

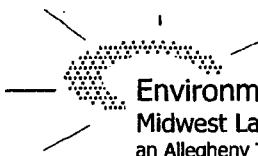

Environmental, Inc.
Midwest Laboratory
an Allegheny Technologies Co.

700 Landwehr Road • Northbrook, IL 60062-2310
(847) 564-0700 fax (847) 564-4517

**FINAL REPORT
TO
CONSUMERS ENERGY COMPANY
JACKSON, MICHIGAN**

**RADIOLOGICAL ENVIRONMENTAL MONITORING PROGRAM (REMP)
FOR
PALISADES NUCLEAR GENERATING PLANT**

**PREPARED AND SUBMITTED
BY
ENVIRONMENTAL INCORPORATED MIDWEST LABORATORY**

Project Number: 8022

Reporting Period: January-December, 2005

Reviewed and
Approved by _____

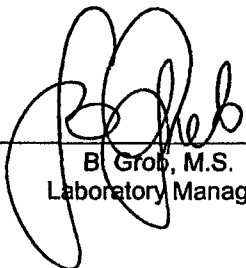
B. Grob, M.S.
Laboratory Manager

Date 02-10-2006

Distribution: J. Burnett (1 copy)

PALISADES

TABLE OF CONTENTS

<u>Section</u>		<u>Page</u>
	List of Tables	iii
1.0	INTRODUCTION.....	iv
2.0	LISTING OF MISSED SAMPLES.....	v

Appendices

A	Interlaboratory Comparison Program Results	A-1
B	Data Reporting Conventions	B-1
C	Special Analyses	C-1

PALISADES

LIST OF TABLES

<u>No.</u>		<u>Page</u>
1	Airborne Particulates and Iodine-131	
	Location 4JS.....	1-4
	Location 5PR.....	1-5
	Location 8SP.....	1-6
	Location 9TP.....	1-7
	Location 10GR.....	1-8
2	Gamma Radiation, as Measured by TLDs, Quarterly Exposure	2-1
3	Lake Water, Intake and South Haven (Raw).....	3-1
4	Well Water, Palisades Drinking Water.....	4-1
5	Well Water, Quarterly.....	5-1
6	Water, Ludington controls	6-1
7	In-Plant Water	7-1
8	Milk	8-1
9	Food Crops.....	9-1
10	Fish.....	10-1
11	Bottom Sediments	11-1
12	Special Samples	
12.1	Liquid Radwaste.....	44 12.1-1
12.2	Stack Filters.....	44 12.2-1

12
12
12

led
5/3/06

1.0 INTRODUCTION

The following constitutes the final 2005 Monthly Progress Report for the Radiological Environmental Monitoring Program conducted at the Consumers Energy Company, Palisades Nuclear Generating Plant. Results of completed analyses are presented in the attached tables.

For all gamma isotopic analyses, spectrum is computer scanned from 80 to 2048 KeV. Specifically included are Mn-54, Fe-59, Co-58, Co-60, Zn-65, Zr-95, Nb-95, I-131, Ba-La-140, Cs-134 and Cs-137. Naturally-occurring gamma-emitters, such as K-40 and Ra daughters, are frequently detected but not listed here. Data listed as "<" are at the 4.66 sigma level, others are 2 sigma.

All concentrations, except gross alpha and gross beta, are decay corrected to the time of collection.

All samples were collected within the scheduled period unless noted otherwise in the Listing of Missed Samples.

PALISADES

2.0 LISTING OF MISSED SAMPLES

Sample Type	Location	Expected Collection Date	Reason
LW	Ludington	March	Sample not received. (Sample received 06-08-05)
WW	South Haven Treated	April	Sample not received. (Sample received 06-08-05)
LW	Ludington	April	Sample not received. (Sample received 06-08-05)
LW	Inlet	April	Sample not received. (Sample received 06-08-05)
LW	Intake	June	Sample not received. (Sample received 08-05-05)
LW	South Haven Raw	June	Sample not received. (Sample received 08-11-05)
WW	South Haven Treated	June	Sample not received. (Sample received 08-05-05)
WW	#14, 15, 16	2nd Qtr.	Sample not received.
LW	Ludington	June	Sample not received. (Sample received 08-05-05)
LW	Ludington	July	Sample not received. (Sample received 09-29-05)
LW	Intake	August	Sample not received. (Sample received 09-29-05)
LW	South Haven Raw	August	Sample not received. (Sample received 09-29-05)
WW	South Haven Treated	August	Sample not received. (Sample received 09-29-05)
LW	Ludington	August	Sample not received. (Sample received 09-29-05)
LW	Intake	September	Sample not received. (Sample received 10-27-05)
LW	South Haven Raw	September	Sample not received. (Sample received 10-27-05)
WW	South Haven Treated	September	Sample not received. (Sample received 10-27-05)
LW	Ludington	September	Sample not received. (Sample received 10-27-05)
LW	Ludington	November	Sample not received. (Sample received 01-12-06.)

PALISADES

Table 1. Airborne particulates and charcoal canisters, analyses for gross beta and iodine-131.

Location: 4JS - Covert (3.5 mi. SE)

Units: pCi/m³

Collection: Continuous, weekly exchange.

Date Collected	Volume (m ³)	Gross Beta	I-131	Date Collected	Volume (m ³)	Gross Beta	I-131
<u>Required LLD</u>		<u>0.010</u>	<u>0.030</u>			<u>0.010</u>	<u>0.030</u>
01-10-05	334	0.029 ± 0.004	< 0.015	07-04-05	312	0.033 ± 0.004	< 0.022
01-17-05	331	0.028 ± 0.004	< 0.012	07-11-05	309	0.028 ± 0.004	< 0.024
01-24-05	337	0.030 ± 0.003	< 0.009	07-18-05	309	0.033 ± 0.004	< 0.023
01-31-05	337	0.030 ± 0.004	< 0.014	07-25-05	303	0.027 ± 0.004	< 0.023
				08-01-05	312	0.024 ± 0.004	< 0.016
02-07-05	331	0.033 ± 0.003	< 0.013				
02-14-05	334	0.021 ± 0.003	< 0.012	08-08-05	317	0.041 ± 0.004	< 0.017
02-21-05	312	0.035 ± 0.004	< 0.014	08-15-05	320	0.037 ± 0.004	< 0.011
02-28-05	337	0.030 ± 0.004	< 0.009	08-22-05	314	0.034 ± 0.004	< 0.027
				08-29-05	320	0.030 ± 0.004	< 0.016
03-07-05	331	0.024 ± 0.003	< 0.012				
03-14-05	334	0.019 ± 0.003	< 0.013	09-05-05	320	0.024 ± 0.004	< 0.023
03-21-05	337	0.022 ± 0.003	< 0.010	09-12-05	317	0.044 ± 0.004	< 0.013
03-28-05	326	0.018 ± 0.003	< 0.011	09-19-05	320	0.036 ± 0.004	< 0.014
				09-26-05	329	0.036 ± 0.004	< 0.008
				10-03-05	320	0.023 ± 0.004	< 0.023
1st Qtr. Mean ± s.d.		0.027 ± 0.006	< 0.015	3rd Qtr. Mean ± s.d.		0.032 ± 0.006	< 0.027
04-04-05	326	0.024 ± 0.003	< 0.014	10-10-05	323	0.022 ± 0.004	< 0.022
04-11-05	320	0.026 ± 0.003	< 0.031	10-17-05	329	0.023 ± 0.003	< 0.014
04-18-05	320	0.026 ± 0.003	< 0.021	10-24-05	329	0.022 ± 0.004	< 0.012
04-26-05	326	0.022 ± 0.003	< 0.012	10-31-05	334	0.022 ± 0.003	< 0.021
05-02-05	323	0.018 ± 0.003	< 0.023				
				11-07-05	331	0.040 ± 0.004	< 0.014
05-09-05	320	0.030 ± 0.003	< 0.014	11-14-05	337	0.040 ± 0.004 ^a	< 0.036
05-16-05	320	0.020 ± 0.003	< 0.017	11-21-05	337	0.027 ± 0.004	< 0.012
05-23-05	320	0.022 ± 0.003	< 0.029	11-28-05	334	0.026 ± 0.004	< 0.021
05-31-05	360	0.018 ± 0.003	< 0.013				
				12-05-05	348	0.021 ± 0.003	< 0.008
06-06-05	269	0.025 ± 0.004	^a < 0.062	12-12-05	351	0.043 ± 0.004 ^a	< 0.046
06-13-05	303	0.025 ± 0.004	^a < 0.034	12-19-05	348	0.036 ± 0.004	< 0.021
06-20-05	314	0.013 ± 0.003	< 0.018	12-27-05	391	0.061 ± 0.004	< 0.021
06-27-05	306	0.037 ± 0.004	< 0.020	01-02-06	295	0.025 ± 0.004	< 0.014
2nd Qtr. Mean ± s.d.		0.024 ± 0.006	< 0.062	4th Qtr. Mean ± s.d.		0.031 ± 0.012	< 0.046
				Cumulative Average		0.029	
				Previous Annual Average		0.027	

^a I-131 LLD not reached due to age of sample.

PALISADES

Table 1. Airborne particulates and charcoal canisters, analyses for gross beta and iodine-131.

Location: 5PR - Covert (3.5 mi. ESE)

Units: pCi/m³

Collection: Continuous, weekly exchange.

Date Collected	Volume (m ³)	Gross Beta	I-131	Date Collected	Volume (m ³)	Gross Beta	I-131
<u>Required LLD</u>		<u>0.010</u>	<u>0.030</u>			<u>0.010</u>	<u>0.030</u>
01-10-05	357	0.032 ± 0.004	< 0.014	07-04-05	326	0.028 ± 0.004	< 0.021
01-17-05	348	0.030 ± 0.004	< 0.012	07-11-05	326	0.026 ± 0.004	< 0.023
01-24-05	360	0.030 ± 0.003	< 0.008	07-18-05	323	0.033 ± 0.004	< 0.022
01-31-05	348	0.026 ± 0.004	< 0.013	07-25-05	320	0.030 ± 0.004	< 0.022
				08-01-05	334	0.023 ± 0.004	< 0.015
02-07-05	343	0.033 ± 0.003	< 0.013				
02-14-05	354	0.021 ± 0.003	< 0.011	08-08-05	329	0.039 ± 0.004	< 0.017
02-21-05	337	0.027 ± 0.004	< 0.013	08-15-05	329	0.034 ± 0.004	< 0.010
02-28-05	351	0.028 ± 0.003	< 0.008	08-22-05	329	0.034 ± 0.004	< 0.026
				08-29-05	334	0.024 ± 0.003	< 0.015
03-07-05	348	0.026 ± 0.003	< 0.012				
03-14-05	348	0.021 ± 0.003	< 0.012	09-05-05	331	0.022 ± 0.003	< 0.022
03-21-05	351	0.019 ± 0.003	< 0.009	09-12-05	331	0.047 ± 0.004	< 0.012
03-28-05	340	0.020 ± 0.003	< 0.010	09-19-05	337	0.037 ± 0.004	< 0.013
				09-26-05	343	0.032 ± 0.004	< 0.008
				10-03-05	334	0.027 ± 0.004	< 0.022
1st Qtr. Mean ± s.d.		0.026 ± 0.005	< 0.014	3rd Qtr. Mean ± s.d.		0.031 ± 0.007	< 0.026
04-04-05	340	0.024 ± 0.003	< 0.013	10-10-05	331	0.027 ± 0.004	< 0.022
04-11-05	331	0.022 ± 0.003	< 0.030	10-17-05	337	0.023 ± 0.003	< 0.014
04-18-05	334	0.027 ± 0.003	< 0.020	10-24-05	337	0.023 ± 0.004	< 0.012
04-26-05	343	0.023 ± 0.003	< 0.011	10-31-05	343	0.022 ± 0.003	< 0.021
05-02-05	334	0.019 ± 0.003	< 0.022				
				11-07-05	337	0.040 ± 0.004	< 0.014
05-09-05	334	0.029 ± 0.003	< 0.013	11-14-05	343	0.037 ± 0.004	< 0.030
05-16-05	334	0.019 ± 0.003	< 0.016	11-21-05	348	0.031 ± 0.004	< 0.012
05-23-05	334	0.023 ± 0.003	< 0.028	11-28-05	351	0.023 ± 0.003	< 0.020
05-31-05	382	0.017 ± 0.002	< 0.012				
				12-05-05	354	0.022 ± 0.003	< 0.007
06-06-05	280	0.026 ± 0.004	^a < 0.059	12-12-05	360	0.045 ± 0.004	^a < 0.045
06-13-05	323	0.024 ± 0.003	^a < 0.032	12-19-05	357	0.035 ± 0.004	< 0.021
06-20-05	327	0.016 ± 0.003	< 0.017	12-27-05	396	0.061 ± 0.004	< 0.021
06-27-05	323	0.035 ± 0.004	< 0.019	01-02-06	300	0.023 ± 0.004	< 0.014
2nd Qtr. Mean ± s.d.		0.023 ± 0.005	< 0.059	4th Qtr. Mean ± s.d.		0.032 ± 0.012	< 0.045
				Cumulative Average		0.028	
				Previous Annual Average		0.025	

^a I-131 LLD not reached due to age of sample.

PALISADES

Table 1. Airborne particulates and charcoal canisters, analyses for gross beta and iodine-131.

Location: 8SP - State Park (1.0 mi. N)

Units: pCi/m³

Collection: Continuous, weekly exchange.

Date Collected	Volume (m ³)	Gross Beta	I-131	Date Collected	Volume (m ³)	Gross Beta	I-131
<u>Required LLD</u>		<u>0.010</u>	<u>0.030</u>			<u>0.010</u>	<u>0.030</u>
01-10-05	368	0.029 ± 0.003	< 0.014	07-04-05	343	0.031 ± 0.004	< 0.020
01-17-05	363	0.031 ± 0.004	< 0.011	07-11-05	340	0.034 ± 0.004	< 0.022
01-24-05	371	0.027 ± 0.003	< 0.008	07-18-05	337	0.035 ± 0.004	< 0.021
01-31-05	371	0.028 ± 0.003	< 0.012	07-25-05	337	0.026 ± 0.004	< 0.020
				08-01-05	346	0.021 ± 0.003	< 0.015
02-07-05	360	0.034 ± 0.003	< 0.012				
02-14-05	365	0.022 ± 0.003	< 0.011	08-08-05	346	0.039 ± 0.004	< 0.016
02-21-05	351	0.028 ± 0.004	< 0.012	08-15-05	331	0.035 ± 0.004	< 0.010
02-28-05	360	0.028 ± 0.003	< 0.008	08-22-05	340	0.033 ± 0.004	< 0.025
				08-29-05	346	0.025 ± 0.003	< 0.015
03-07-05	363	0.022 ± 0.003	< 0.011				
03-14-05	363	0.021 ± 0.003	< 0.012	09-05-05	346	0.023 ± 0.003	< 0.021
03-21-05	363	0.020 ± 0.003	< 0.009	09-12-05	340	0.047 ± 0.004	< 0.012
03-28-05	351	0.019 ± 0.003	< 0.010	09-19-05	348	0.038 ± 0.004	< 0.013
				09-26-05	357	0.038 ± 0.004	< 0.007
				10-03-05	346	0.020 ± 0.003	< 0.021
1st Qtr. Mean ± s.d.		0.026 ± 0.005	< 0.014	3rd Qtr. Mean ± s.d.		0.032 ± 0.008	< 0.025
04-04-05	351	0.024 ± 0.003	< 0.013	10-10-05	351	0.029 ± 0.004	< 0.020
04-11-05	343	0.024 ± 0.003	< 0.029	10-17-05	354	0.022 ± 0.003	< 0.013
04-18-05	346	0.027 ± 0.003	< 0.020	10-24-05	360	0.022 ± 0.003	< 0.011
04-26-05	351	0.021 ± 0.003	< 0.011	10-31-05	363	0.019 ± 0.003	< 0.020
05-02-05	346	0.016 ± 0.003	< 0.021				
				11-07-05	357	0.036 ± 0.004	< 0.013
05-09-05	343	0.028 ± 0.003	< 0.013	11-14-05	360	0.037 ± 0.004	^a < 0.040
05-16-05	346	0.020 ± 0.003	< 0.016	11-21-05	371	0.024 ± 0.003	< 0.011
05-23-05	340	0.021 ± 0.003	< 0.028	11-28-05	371	0.025 ± 0.003	< 0.018
05-31-05	402	0.015 ± 0.002	< 0.012				
				12-05-05	391	0.018 ± 0.003	< 0.007
06-06-05	295	0.025 ± 0.004	^a < 0.056	12-12-05	385	0.042 ± 0.004	^a < 0.042
06-13-05	340	0.026 ± 0.003	^a < 0.030	12-19-05	379	0.040 ± 0.004	< 0.019
06-20-05	346	0.016 ± 0.003	< 0.016	12-27-05	422	0.058 ± 0.004	< 0.020
06-27-05	337	0.035 ± 0.003	< 0.018	01-02-06	320	0.022 ± 0.003	< 0.013
2nd Qtr. Mean ± s.d.		0.023 ± 0.006	< 0.056	4th Qtr. Mean ± s.d.		0.030 ± 0.012	< 0.042
Cumulative Average						0.028	
Previous Annual Average						0.026	

^a I-131 LLD not reached due to age of sample.

PALISADES

Table 1. Airborne particulates and charcoal canisters, analyses for gross beta and iodine-131.

Location: 9TP - Covert Township Park (1.5 mi. SSW)

Units: pCi/m³

Collection: Continuous, weekly exchange.

Date Collected	Volume (m ³)	Gross Beta	I-131	Date Collected	Volume (m ³)	Gross Beta	I-131
<u>Required LLD</u>		<u>0.010</u>	<u>0.030</u>			<u>0.010</u>	<u>0.030</u>
01-10-05	356	0.033 ± 0.004	< 0.014	07-04-05	329	0.028 ± 0.004	< 0.021
01-17-05	360	0.033 ± 0.004	< 0.011	07-11-05	329	0.031 ± 0.004	< 0.022
01-24-05	368	0.029 ± 0.003	< 0.008	07-18-05	329	0.033 ± 0.003	< 0.022
01-31-05	368	0.029 ± 0.004	< 0.012	07-25-05	320	0.031 ± 0.004	< 0.022
				08-01-05	329	0.022 ± 0.004	< 0.016
02-07-05	357	0.034 ± 0.003	< 0.012				
02-14-05	363	0.021 ± 0.003	< 0.011	08-08-05	329	0.036 ± 0.004	< 0.017
02-21-05	346	0.030 ± 0.004	< 0.012	08-15-05	272	0.043 ± 0.005	< 0.013
02-28-05	363	0.030 ± 0.003	< 0.008	08-22-05	286	0.032 ± 0.004	< 0.029
				08-29-05	337	0.024 ± 0.003	< 0.015
03-07-05	357	0.023 ± 0.003	< 0.012				
03-14-05	360	0.025 ± 0.003	< 0.012	09-05-05	334	0.025 ± 0.003	< 0.022
03-21-05	363	0.024 ± 0.003	< 0.009	09-12-05	331	0.046 ± 0.004	< 0.012
03-28-05	348	0.020 ± 0.003	< 0.010	09-19-05	337	0.036 ± 0.004	< 0.013
				09-26-05	343	0.038 ± 0.004	< 0.008
				10-03-05	320	0.024 ± 0.004	< 0.023
1st Qtr. Mean ± s.d.		0.028 ± 0.005	< 0.014	3rd Qtr. Mean ± s.d.		0.032 ± 0.007	< 0.029
04-04-05	346	0.022 ± 0.003	< 0.013	10-10-05	340	0.025 ± 0.004	< 0.021
04-11-05	340	0.023 ± 0.003	< 0.029	10-17-05	340	0.026 ± 0.004	< 0.014
04-18-05	343	0.028 ± 0.003	< 0.020	10-24-05	346	0.023 ± 0.003	< 0.012
04-26-05	348	0.024 ± 0.003	< 0.011	10-31-05	348	0.021 ± 0.003	< 0.020
05-02-05	343	0.017 ± 0.003	< 0.021				
				11-07-05	343	0.040 ± 0.004	< 0.013
05-09-05	340	0.031 ± 0.003	< 0.013	11-14-05	348	0.036 ± 0.004 ^a	< 0.038
05-16-05	334	0.020 ± 0.003	< 0.016	11-21-05	351	0.025 ± 0.003	< 0.012
05-23-05	343	0.021 ± 0.003	< 0.028	11-28-05	357	0.026 ± 0.003	< 0.019
05-31-05	385	0.017 ± 0.002	< 0.012				
				12-05-05	360	0.023 ± 0.003	< 0.007
06-06-05	269	0.031 ± 0.004 ^a	< 0.062	12-12-05	368	0.046 ± 0.004 ^a	< 0.044
06-13-05	326	0.027 ± 0.004 ^a	< 0.032	12-19-05	363	0.034 ± 0.004	< 0.020
06-20-05	331	0.014 ± 0.003	< 0.017	12-27-05	408	0.062 ± 0.004	< 0.020
06-27-05	323	0.033 ± 0.003	< 0.019	01-02-06	306	0.027 ± 0.004	< 0.014
2nd Qtr. Mean ± s.d.		0.024 ± 0.006	< 0.062	4th Qtr. Mean ± s.d.		0.032 ± 0.012	< 0.044
				Cumulative Average		0.029	
				Previous Annual Average		0.026	

^a I-131 LLD not reached due to age of sample.

PALISADES

Table 1. Airborne particulates and charcoal canisters, analyses for gross beta and iodine-131.

Location: 10GR - Grand Rapids (55 mi. NNE)

Units: pCi/m³

Collection: Continuous, weekly exchange.

Date Collected	Volume (m ³)	Gross Beta	I-131	Date Collected	Volume (m ³)	Gross Beta	I-131
Required LLD		0.010	0.030			0.010	0.030
01-05-05	348	0.042 ± 0.004	< 0.022	07-06-05	286	0.030 ± 0.004	^a < 0.040
01-12-05	337	0.040 ± 0.004	< 0.019	07-14-05	337	0.037 ± 0.004	^a < 0.031
01-19-05	357	0.030 ± 0.003	< 0.013	07-20-05	263	0.035 ± 0.005	^a < 0.038
01-26-05	351	0.027 ± 0.004	< 0.020	07-27-05	331	0.028 ± 0.004	< 0.024
02-02-05	348	0.027 ± 0.003	< 0.019	08-03-05	312	0.036 ± 0.004	< 0.027
02-09-05	320	0.036 ± 0.004	< 0.020	08-10-05	317	0.043 ± 0.004	< 0.017
02-16-05	343	0.031 ± 0.004	< 0.019	08-17-05	329	0.035 ± 0.004	^a < 0.039
02-23-05	346	0.027 ± 0.003	< 0.013	08-24-05	314	0.026 ± 0.004	< 0.018
03-03-05	399	0.025 ± 0.003	< 0.015	08-31-05	326	0.031 ± 0.004	< 0.022
03-09-05	357	0.027 ± 0.004	< 0.021	09-08-05	371	0.029 ± 0.003	< 0.016
03-16-05	337	0.023 ± 0.003	< 0.015	09-14-05	275	0.062 ± 0.005	< 0.024
03-23-05	337	0.020 ± 0.003	< 0.016	09-21-05	320	0.036 ± 0.004	< 0.013
03-30-05	334	0.023 ± 0.003	< 0.016	09-28-05	331	0.033 ± 0.004	< 0.034
1st Qtr. Mean ± s.d.		0.029 ± 0.007	< 0.022	3rd Qtr. Mean ± s.d.		0.035 ± 0.009	< 0.040
04-06-05	329	0.027 ± 0.003	< 0.046	10-05-05	323	0.035 ± 0.004	^a < 0.034
04-13-05	340	0.026 ± 0.003	< 0.030	10-12-05	334	0.022 ± 0.003	< 0.022
04-21-05	363	0.029 ± 0.003	< 0.017	10-19-05	331	0.025 ± 0.004	< 0.019
04-27-05	295	0.018 ± 0.003	< 0.038	10-26-05	340	0.018 ± 0.003	< 0.032
				11-02-05	337	0.026 ± 0.004	< 0.021
05-04-05	331	0.018 ± 0.003	< 0.020	11-09-05	331	0.048 ± 0.005	< 0.029
05-12-05	371	0.032 ± 0.003	< 0.022	11-16-05	343	0.023 ± 0.003	< 0.018
05-18-05	286	0.021 ± 0.003	< 0.049	11-23-05	340	0.031 ± 0.004	^a < 0.031
05-25-05	329	0.021 ± 0.003	< 0.023	11-30-05	351	0.026 ± 0.003	< 0.011
06-01-05	326	0.020 ± 0.003	^a < 0.083	12-07-05	346	0.025 ± 0.003	^a < 0.061
06-08-05	317	0.023 ± 0.004	^a < 0.051	12-14-05	354	0.038 ± 0.004	^a < 0.032
06-15-05	295	0.025 ± 0.004	< 0.029	12-22-05	402	0.044 ± 0.004	^a < 0.032
06-23-05	326	0.019 ± 0.003	< 0.027	12-28-05	286	0.057 ± 0.005	< 0.023
06-29-05	235	0.054 ± 0.006	^a < 0.044				
2nd Qtr. Mean ± s.d.		0.026 ± 0.010	< 0.083	4th Qtr. Mean ± s.d.		0.032 ± 0.012	< 0.061
Cumulative Average						0.031	
Previous Annual Average						0.028	

^a I-131 LLD not reached due to age of sample.

PALISADES

Table 2. Gamma radiation, as measured by TLDs, quarterly exposure.
Units: mR/91 days^a

	<u>1st Qtr.</u>	<u>2nd Qtr.</u>	<u>3rd Qtr.</u>	<u>4th Qtr.</u>
Date Placed	12-30-04	03-28-05	06-30-05	09-30-05
Date Removed	03-28-05	06-30-05	09-30-05	01-03-06
Intransit (mR)	2.4 ± 0.2	1.0 ± 0.6	2.2 ± 0.2	1.1 ± 0.5
ST-01	11.2 ± 0.7	12.8 ± 0.8	12.0 ± 0.7	13.1 ± 0.5
ST-02	15.1 ± 0.9	17.4 ± 0.7	17.9 ± 0.9	18.3 ± 0.7
ST-03	12.9 ± 0.3	14.6 ± 0.7	15.0 ± 0.4	15.1 ± 0.6
ST-04	13.6 ± 0.7	15.6 ± 0.8	15.3 ± 0.7	15.8 ± 0.6
ST-05	13.5 ± 0.4	15.6 ± 0.9	14.9 ± 0.3	15.4 ± 0.6
ST-06	12.6 ± 0.4	13.6 ± 0.6	14.3 ± 0.4	13.9 ± 0.6
ST-07A	11.8 ± 0.5	12.6 ± 0.8	12.6 ± 0.4	13.3 ± 0.6
ST-08	11.9 ± 0.5	13.9 ± 0.8	12.8 ± 0.5	13.7 ± 0.7
ST-09	11.1 ± 0.4	13.0 ± 0.6	11.9 ± 0.5	13.2 ± 0.5
ST-10	12.8 ± 0.6	14.2 ± 0.7	13.9 ± 0.4	14.8 ± 0.6
ST-11	15.9 ± 1.4	16.9 ± 0.6	16.7 ± 1.0	17.2 ± 0.8
ST-12	12.3 ± 0.5	14.9 ± 0.6	15.3 ± 0.7	15.2 ± 0.5
ST-13	11.2 ± 0.6	13.2 ± 0.8	12.2 ± 0.7	13.0 ± 0.5
ST-14	10.0 ± 0.5	11.4 ± 0.6	10.6 ± 0.5	11.7 ± 0.6
ST-15	10.8 ± 1.1	12.4 ± 0.7	11.2 ± 0.6	12.5 ± 0.6
ST-16	9.7 ± 0.8	12.2 ± 0.7	11.4 ± 0.3	12.3 ± 0.6
ST-17	10.3 ± 0.3	11.9 ± 0.9	11.0 ± 0.3	12.3 ± 0.7
ST-18	11.3 ± 0.3	13.4 ± 0.9	12.3 ± 0.3	13.4 ± 0.6
ST-19	11.3 ± 0.3	13.4 ± 0.6	12.9 ± 0.4	13.2 ± 0.5
ST-20	9.6 ± 0.3	12.8 ± 0.6	11.2 ± 0.3	13.0 ± 0.5
ST-21	11.3 ± 0.4	11.9 ± 0.8	12.5 ± 0.4	12.1 ± 0.8
ST-22	7.2 ± 0.7	7.5 ± 0.6	7.3 ± 0.3	7.3 ± 0.6
ST-23	11.5 ± 0.6	13.9 ± 0.6	13.3 ± 0.7	14.0 ± 0.6
ST-24	12.2 ± 0.5	15.6 ± 0.8	14.4 ± 0.4	15.6 ± 0.6
ST-33	10.1 ± 0.4	11.9 ± 0.8	11.1 ± 0.6	12.3 ± 0.8
ST-34	10.6 ± 0.5	12.4 ± 0.6	11.4 ± 0.4	12.6 ± 0.6
ST-35	13.4 ± 0.5	14.6 ± 0.7	14.5 ± 0.6	14.7 ± 0.7
ST-36	10.7 ± 0.4	12.3 ± 0.7	11.7 ± 0.6	12.7 ± 0.7
ST-37	11.4 ± 0.6	12.8 ± 0.8	12.1 ± 0.7	13.0 ± 0.8
ST-38	10.6 ± 0.9	12.5 ± 0.8	11.1 ± 0.5	12.5 ± 0.7
Mean ± s.d.	11.6 ± 1.7	13.4 ± 1.9	12.8 ± 2.1	13.6 ± 2.0
Control 1	6.6 ± 0.4	7.3 ± 0.6	6.7 ± 0.4	7.2 ± 0.6
Control 2	6.9 ± 0.7	7.4 ± 0.6	6.6 ± 0.3	7.3 ± 0.6

^a Intransit exposure has been subtracted.

PALISADES

Table 3. Lake Water, analyses for gross alpha, gross beta and tritium.
 Collection: Monthly composites of daily collections.
 Units: pCi/L

Location Date Collected	Lab Code	Intake	
		Gross Beta	H-3
<u>Required LLD</u>		<u>4.0</u>	<u>500</u>
01-13-05	PALW -640	1.6 ± 0.8	< 166
02-28-05	PALW -1092	1.7 ± 0.4	< 147
03-31-05	PALW -1788	1.8 ± 0.7	< 171
04-30-05	PALW -3132	1.3 ± 0.4	< 165
05-31-05	PALW -3128	1.5 ± 0.4	< 167
06-30-05	PALW -4480	2.8 ± 0.7	241 ± 97
07-31-05	PALW -4484	1.7 ± 0.7	255 ± 97
08-31-05	PALW -5360	1.6 ± 0.4	< 171
09-30-05	PALW -6128	1.4 ± 0.3	397 ± 99
10-31-05	PALW -6985	2.0 ± 0.7	< 166
11-30-05	PALW -6988	1.5 ± 0.4	< 166
12-31-05	PALW -7456	1.6 ± 0.7	< 184

Lake Water, analysis for gross beta.
 Collection: Monthly composites of daily collections.
 Units: pCi/L

Location Date Collected	Lab Code	South Haven Municipal System (Raw)
		Gross Beta
<u>Required LLD</u>		<u>4.0</u>
01-31-05	PALW -642	2.1 ± 0.6
02-28-05	PALW -1094	1.3 ± 0.3
03-31-05	PALW -1789	2.6 ± 0.6
04-30-05	PALW -2353	2.3 ± 0.6
05-31-05	PALW -3147	1.5 ± 0.4
06-30-05	PALW -4632	2.2 ± 0.6
07-31-05	PALW -4633	2.0 ± 0.5
08-31-05	PALW -5363	0.9 ± 0.3
09-30-05	PALW -6131	1.4 ± 0.3
10-31-05	PALW -6439	2.1 ± 0.4
11-30-05	PALW -6989	1.7 ± 0.4
12-31-05	PALW -7458	2.2 ± 0.6

led 5/9/06

South Haven Treated PALISADES

Table 4. ~~Well water~~, analyses for gross beta and tritium.
Collection: Monthly composites of daily collections.
Units: pCi/L

Location	South Haven Municipal System (Treated)		
Date Collected	Lab Code	Gross Beta	H-3
<u>Required LLD</u>		<u>4.0</u>	<u>500</u>
01-31-05	PAWW -643	3.0 ± 0.6	< 166
02-28-05	PAWW -1095	2.0 ± 0.3	< 147
03-31-05	PAWW -1790	2.4 ± 0.6	< 171
04-30-05	PAWW -3134	1.4 ± 0.4	< 165
05-31-05	PAWW -3130	1.5 ± 0.4	< 165
06-30-05	PAWW -4482	1.1 ± 0.3	287 ± 99
07-31-05	PAWW -4485	1.9 ± 0.6	245 ± 114
08-31-05	PAWW -5364	1.1 ± 0.3	< 171
09-30-05	PAWW -6132	2.5 ± 0.6	322 ± 96
10-31-05	PAWW -6986	1.1 ± 0.6	< 166
11-30-05	PAWW -6990	1.3 ± 0.3	< 181
12-31-05	PAWW -7459	1.7 ± 0.6	< 190

PALISADES

Table 5. Well water, analyses for gross beta and tritium.

Collection: Quarterly

Units: pCi/L

Location	Site Well #14			
	Date Collected	Lab Code	Gross Beta	H-3
<u>Required LLD</u>			<u>4.0</u>	<u>500</u>
03-29-05	PAWW -1348		4.2 ± 0.8	< 166
06-30-05	ND ^a		- -	-
09-30-05	PAWW -6133		4.2 ± 0.7	301 ± 95
11-21-05	PAWW -6991		3.6 ± 0.5	< 181

Location	Site Well #15			
	Date Collected	Lab Code	Gross Beta	H-3
<u>Required LLD</u>			<u>4.0</u>	<u>500</u>
03-29-05	PAWW -1349		4.1 ± 0.7	< 166
06-30-05	ND ^a		- -	-
09-30-05	PAWW -6134		3.7 ± 0.7	316 ± 96
11-21-05	PAWW -6992		2.8 ± 0.5	< 181

NOTE: Gamma isotopic analysis required if gross beta exceeds 10 pCi/L. Results listed in Appendix C.

^a"ND" = No data; sample not received.

PALISADES

Table 5. Well water, analyses for gross beta and tritium.

Collection: Quarterly

Units: pCi/L

Location	Site Well #16		
Date Collected	Lab Code	Gross Beta	H-3
<u>Required LLD</u>		<u>4.0</u>	<u>500</u>
03-29-05	PAWW -1350	6.1 ± 0.9	< 166
06-30-05	ND ^a	- -	-
09-30-05	PAWW -6135	5.3 ± 0.8	364 ± 98
11-21-05	PAWW -6993	4.8 ± 0.6	< 181

NOTE: Gamma isotopic analysis required if gross beta exceeds 10 pCi/L. Results listed in Appendix C.

^a"ND" = No data; sample not received.

PALISADES

Table 6. Water, Ludington controls, analyses for gross beta, tritium and strontium.

Collection: Monthly composites of daily collections.

Units: pCi/L

Location	Ludington (Lake In)				
Date Collected	Lab Code	Gross Beta	H-3	Sr-89	Sr-90
Required LLD		4.0	500	5.0	1.0
02-08-05	PALW -641	2.9 ± 0.8	< 166	< 0.4	< 0.7
03-07-05	PALW -1093	1.3 ± 0.4	< 147	< 0.5	< 0.6
04-11-05	PALW -3126	1.6 ± 0.4	< 168	< 1.1	< 0.5
05-03-05	PALW -3133	1.4 ± 0.4	< 165	< 0.8	< 0.5
06-01-05	PALW -3129	1.4 ± 0.4	< 167	< 0.6	< 0.5
07-12-05	PALW -4481	2.3 ± 0.6	< 165	< 0.8	< 0.6
08-01-05	PALW -5359	1.2 ± 0.3	< 172	< 1.3	< 0.7
09-12-05	PALW 5361,2	1.1 ± 0.2	< 171	< 0.8	< 0.6
10-11-05	PALW 6129,30	1.6 ± 0.2	337 ± 68	< 0.7	< 0.5
10-31-05	PALW -6438	1.8 ± 0.4	< 179	< 0.3	< 0.2
12-05-05	PALW -7454	1.8 ± 0.6	< 185	< 0.9	< 0.6
01-03-06	PALW -7457	2.9 ± 0.6	< 184	< 0.6	< 0.6

^a"ND" = No data; sample not received.

PALISADES

Table 7. In-Plant water, analyses for gross alpha, gross beta, strontium-89, strontium-90, tritium and gamma emitting isotopes.

Collection: Monthly composites

Units: uCi/mL

Location		Service Water			
Date Collected	Required	01-31-05	02-28-05	03-31-05	
Lab Code	LLD	PACW-639	PACW-1091	PACW-1787	
Gross Alpha	1.0 E-07	< 7.7 E-10	< 9.0 E-10	< 4.6 E-10	
Gross Beta	1.0 E-09	2.1 ± 0.6 E-09	1.4 ± 0.4 E-09	1.6 ± 0.3 E-09	
H-3	1.0 E-05	< 1.7 E-07	< 1.6 E-07	< 1.7 E-07	
Sr-89	5.0 E-08	< 1.1 E-09	< 4.5 E-10	< 6.2 E-10	
Sr-90	5.0 E-08	< 7.1 E-10	< 4.8 E-10	< 5.5 E-10	
Cs-137	5.0 E-07	< 1.7 E-09	< 3.5 E-09	< 2.8 E-09	
Others ^a	5.0 E-07	< 2.3 E-09	< 2.0 E-09	< 2.6 E-09	
Date Collected	Required	04-30-05	05-31-06	06-30-05	
Lab Code	LLD	PACW-3131	PACW-3127	PACW-4479	
Gross Alpha	1.0 E-07	< 8.3 E-10	< 7.9 E-10	< 9.4 E-10	
Gross Beta	1.0 E-09	1.5 ± 0.4 E-09	1.5 ± 0.4 E-09	3.1 ± 0.8 E-09	
H-3	1.0 E-05	1.3 ± 0.1 E-06	< 1.7 E-07	< 1.7 E-07	
Sr-89	5.0 E-08	< 9.2 E-10	< 7.0 E-10	< 8.3 E-10	
Sr-90	5.0 E-08	< 5.6 E-10	< 5.9 E-10	< 5.9 E-10	
Cs-137	5.0 E-07	< 1.5 E-09	< 3.3 E-09	< 1.1 E-09	
Others ^a	5.0 E-07	< 1.1 E-09	< 4.5 E-09	< 1.4 E-09	
Date Collected	Required	07-31-05	08-31-05	09-30-05	
Lab Code	LLD	PACW-4483	PACW-5358	PACW-6127	
Gross Alpha	1.0 E-07	< 9.0 E-10	< 1.2 E-09	1.1 ± 0.5 E-09	
Gross Beta	1.0 E-09	2.0 ± 0.5 E-09	2.1 ± 0.8 E-09	1.7 ± 0.3 E-09	
H-3	1.0 E-05	< 1.7 E-07	< 1.7 E-07	2.8 ± 0.2 E-06	
Sr-89	5.0 E-08	< 7.2 E-10	< 7.3 E-10	< 8.0 E-10	
Sr-90	5.0 E-08	< 6.7 E-10	< 6.9 E-10	< 7.7 E-10	
Cs-137	5.0 E-07	< 2.1 E-09	< 1.5 E-09	< 2.1 E-09	
Others ^a	5.0 E-07	< 3.5 E-09	< 1.4 E-09	< 2.1 E-09	

^a Co-60

PALISADES

Table 7. In-Plant water, analyses for gross alpha, gross beta, strontium-89, strontium-90, tritium and gamma emitting isotopes.

Collection: Monthly composites

Units: uCi/mL

Location	Service Water			
Date Collected	Required	10-31-05	11-30-05	12-31-05
Lab Code	LLD	PACW-6984	PACW-6987	PACW-7455
Gross Alpha	1.0 E-07	< 4.6 E-10	< 1.2 E-09	< 9.2 E-10
Gross Beta	1.0 E-09	1.8 ± 0.4 E-09	3.8 ± 0.9 E-09	3.2 ± 0.7 E-09
H-3	1.0 E-05	< 1.7 E-07	< 1.7 E-07	2.7 ± 1.1 E-07
Sr-89	5.0 E-08	< 8.7 E-10	< 7.1 E-10	< 7.2 E-10
Sr-90	5.0 E-08	< 5.3 E-10	< 6.7 E-10	< 6.4 E-10
Cs-137	5.0 E-07	< 1.6 E-09	< 4.9 E-09	< 2.1 E-09
Others ^a	5.0 E-07	< 1.1 E-09	< 2.5 E-09	< 2.6 E-09

^a Co-60

PALISADES

Table 7. In-Plant water, analyses for gross alpha, gross beta, strontium-89, strontium-90, tritium and gamma emitting isotopes.

Collection: Monthly composites

Units: uCi/mL

Location		Turbine Sump			
Date Collected	Required	01-31-05	02-28-05	03-31-05	
Lab Code	LLD	PACW-638	PACW-1198	PACW-6369	
Gross Alpha	1.0 E-07	< 9.9 E-10	< 7.7 E-10	< 6.7 E-10	
Gross Beta	1.0 E-09	1.3 ± 0.7 E-09	9.0 ± 3.6 E-10	5.7 ± 3.4 E-10	
H-3	1.0 E-05	5.5 ± 0.2 E-06	3.6 ± 0.2 E-06	1.5 ± 0.1 E-05	
Sr-89	5.0 E-08	< 6.8 E-10	< 2.9 E-09	< 8.4 E-09	
Sr-90	5.0 E-08	9.4 ± 4.3 E-10	3.9 ± 1.7 E-09	< 3.1 E-10	
Cs-137	5.0 E-07	< 2.9 E-09	< 2.4 E-09	< 1.6 E-09	
Others ^a	5.0 E-07	< 1.5 E-09	< 3.0 E-09	< 1.3 E-09	
Date Collected	Required	04-30-05	05-31-05	06-30-05	
Lab Code	LLD	PACW-6370	PACW-6371	PACW-6372	
Gross Alpha	1.0 E-07	< 6.4 E-10	< 5.9 E-10	< 5.7 E-10	
Gross Beta	1.0 E-09	< 6.0 E-10	< 5.6 E-10	< 5.7 E-10	
H-3	1.0 E-05	1.8 ± 0.1 E-05	2.3 ± 0.1 E-05	1.3 ± 0.1 E-05	
Sr-89	5.0 E-08	< 4.5 E-09	< 2.7 E-09	< 1.9 E-09	
Sr-90	5.0 E-08	< 2.8 E-10	< 2.3 E-10	< 2.5 E-10	
Cs-137	5.0 E-07	< 1.4 E-09	< 1.4 E-09	< 1.8 E-09	
Others ^a	5.0 E-07	< 1.0 E-09	< 1.2 E-09	< 1.3 E-09	
Date Collected	Required	07-31-05	08-31-05	09-30-05	
Lab Code	LLD	PACW-6373	PACW-6374	PACW-6375	
Gross Alpha	1.0 E-07	< 6.3 E-10	< 5.7 E-10	< 3.8 E-10	
Gross Beta	1.0 E-09	< 5.7 E-10	< 6.0 E-10	1.5 ± 0.4 E-10	
H-3	1.0 E-05	2.0 ± 0.1 E-05	2.1 ± 0.1 E-05	1.6 ± 0.1 E-05	
Sr-89	5.0 E-08	< 1.3 E-09	< 9.8 E-10	< 5.4 E-10	
Sr-90	5.0 E-08	< 2.9 E-10	< 3.0 E-10	< 2.9 E-10	
Cs-137	5.0 E-07	< 1.6 E-09	< 1.5 E-09	< 1.7 E-09	
Others ^a	5.0 E-07	< 1.1 E-09	< 9.2 E-10	< 1.2 E-09	

^a Co-60

PALISADES

Table 7. In-Plant water, analyses for gross alpha, gross beta, strontium-89, strontium-90, tritium and gamma emitting isotopes.

Collection: Monthly composites

Units: uCi/mL

Location	Turbine Sump			
	Date Collected Lab Code	Required LLD	10-31-05 PACW-7588	11-30-05 PACW-7589
Gross Alpha	1.0 E-07	4.5 ± 2.0 E-10	< 4.1 E-10	< 3.7 E-10
Gross Beta	1.0 E-09	6.6 ± 2.0 E-10	2.3 ± 0.5 E-09	9.7 ± 4.2 E-10
H-3	1.0 E-05	1.0 ± 0.1 E-05	4.8 ± 0.2 E-06	4.4 ± 0.2 E-06
Sr-89	5.0 E-08	< 2.1 E-09	< 1.3 E-09	< 1.0 E-09
Sr-90	5.0 E-08	< 4.9 E-10	< 5.8 E-10	< 6.0 E-10
Cs-137	5.0 E-07	< 1.2 E-09	< 1.1 E-09	< 9.6 E-10
Others ^a	5.0 E-07	< 1.7 E-09	< 1.4 E-09	< 1.2 E-09

^a Co-60

PALISADES

Table 8. Milk, analyses for iodine-131 and gamma emitting isotopes,
Collection: Monthly

Location		JH - Joseph Hay Farm				
Date	Lab	Concentration (pCi/L)				
Collected	Code	I-131	K-40	Cs-134	Cs-137	Ba-La-140
<u>Required LLD</u>		<u>1.0</u>	-	<u>15.0</u>	<u>18.0</u>	<u>15.0</u>
01-11-05	PAMI -151	< 0.3	1416 ± 122	< 3.8	< 4.0	< 3.9
02-08-05	PAMI -566	< 0.2	1194 ± 105	< 3.1	< 2.5	< 1.2
03-08-05	PAMI -1089	< 0.3	1301 ± 69	< 3.2	< 2.4	< 2.1
04-05-05	PAMI -1599	< 0.2	1198 ± 95	< 4.0	< 3.6	< 3.2
05-03-05	PAMI -2263	< 0.2	1322 ± 109	< 3.5	< 4.0	< 2.6
06-07-05	PAMI -3118	< 0.3	1351 ± 101	< 2.3	< 3.4	< 3.1
07-05-05	PAMI -3675	< 0.3	1229 ± 114	< 2.5	< 3.0	< 1.8
08-09-05	PAMI -4568	< 0.2	1377 ± 109	< 4.8	< 4.3	< 2.3
09-08-05	PAMI -5005	< 0.5	1370 ± 84	< 2.9	< 3.0	< 4.3
10-11-05	PAMI -5699	< 0.2	1232 ± 101	< 4.1	< 3.7	< 3.2
11-08-05	PAMI -6388	< 0.3	1296 ± 116	< 4.8	< 3.7	< 2.1
12-06-05	PAMI -6934	< 0.3	1246 ± 94	< 3.9	< 4.0	< 1.5

Location		DC - Danny Carpenter Farm				
Date	Lab	Concentration (pCi/L)				
Collected	Code	I-131	K-40	Cs-134	Cs-137	Ba-La-140
<u>Required LLD</u>		<u>1.0</u>	-	<u>15.0</u>	<u>18.0</u>	<u>15.0</u>
01-11-05	PAMI -149	< 0.3	1257 ± 219	< 5.5	< 6.8	< 11.2
02-08-05	PAMI -563	< 0.2	1249 ± 99	< 4.6	< 3.9	< 2.8
03-08-05	PAMI -1087	< 0.3	1187 ± 103	< 4.6	< 4.3	< 3.5
04-05-05	PAMI -1597	< 0.2	1321 ± 113	< 4.4	< 2.8	< 4.4
05-03-05	PAMI 2260,1	< 0.3	1117 ± 77	< 3.6	< 4.4	< 1.8
06-07-05	PAMI -3116	< 0.3	1338 ± 110	< 4.1	< 2.6	< 3.5
07-05-05	PAMI -3673	< 0.3	1250 ± 106	< 2.6	< 3.8	< 3.6
08-09-05	PAMI -4566	< 0.2	1085 ± 101	< 2.6	< 4.5	< 3.5
09-08-05	PAMI -5003	< 0.2	1373 ± 85	< 3.2	< 3.2	< 4.5
10-11-05	PAMI -5697	< 0.2	1311 ± 117	< 3.7	< 4.5	< 4.0
11-08-05	PAMI -6386	< 0.3	1091 ± 100	< 4.5	< 4.1	< 2.6
12-06-05	PAMI -6932	< 0.3	1388 ± 105	< 3.0	< 4.2	< 3.1

PALISADES

Table 8. Milk, analyses for iodine-131 and gamma emitting isotopes,
Collection: Monthly

Location		DH - Dennis Hessey Farm				
Date	Lab	Concentration (pCi/L)				
Collected	Code	I-131	K-40	Cs-134	Cs-137	Ba-La-140
<u>Required LLD</u>		<u>1.0</u>	-	<u>15.0</u>	<u>18.0</u>	<u>15.0</u>
01-11-05	PAMI -150	< 0.3	1122 ± 196	< 5.7	< 8.5	< 11.4
02-08-05	PAMI 564,5	< 0.3	1304 ± 115	< 3.3	< 4.5	< 3.0
03-08-05	PAMI -1088	< 0.3	1223 ± 114	< 2.6	< 3.8	< 4.5
04-05-05	PAMI -1598	< 0.2	1356 ± 113	< 3.2	< 3.7	< 3.9
05-03-05	PAMI -2262	< 0.3	1277 ± 106	< 3.2	< 3.9	< 1.6
06-07-05	PAMI -3117	< 0.3	1267 ± 109	< 3.8	< 3.8	< 2.9
07-05-05	PAMI -3674	< 0.3	1397 ± 115	< 4.8	< 2.7	< 2.2
08-09-05	PAMI -4567	< 0.2	1386 ± 113	< 4.2	< 3.9	< 2.9
09-08-05	PAMI -5004	< 0.3	1353 ± 112	< 3.0	< 2.0	< 3.1
10-11-05	PAMI -5698	< 0.3	1259 ± 108	< 3.1	< 3.2	< 3.1
11-08-05	PAMI -6387	< 0.3	1229 ± 114	< 3.3	< 3.1	< 4.3
12-06-05	PAMI -6933	< 0.2	1462 ± 106	< 4.5	< 4.4	< 1.4

Location		WS - William Shine Farm				
Date	Lab	Concentration (pCi/L)				
Collected	Code	I-131	K-40	Cs-134	Cs-137	Ba-La-140
<u>Required LLD</u>		<u>1.0</u>	-	<u>15.0</u>	<u>18.0</u>	<u>15.0</u>
01-11-05	PAMI -152	< 0.3	1487 ± 219	< 8.0	< 8.1	< 8.4
02-08-05	PAMI -567	< 0.2	1153 ± 151	< 4.6	< 4.2	< 2.9
03-08-05	PAMI -1090	< 0.3	1378 ± 83	< 3.5	< 3.6	< 4.0
04-05-05	PAMI -1600	< 0.2	1392 ± 85	< 3.2	< 2.8	< 4.4
05-03-05	PAMI -2264	< 0.2	1286 ± 108	< 3.4	< 4.6	< 2.7
06-07-05	PAMI -3119	< 0.3	1440 ± 105	< 4.7	< 4.9	< 1.8
07-05-05	PAMI 3676,7	< 0.3	1406 ± 85	< 2.7	< 3.3	< 2.0
08-09-05	PAMI -4569	< 0.2	1478 ± 112	< 4.5	< 1.9	< 2.1
09-08-05	PAMI -5006	< 0.2	1530 ± 84	< 3.3	< 2.6	< 2.5
10-11-05	PAMI -5700	< 0.2	1205 ± 103	< 3.4	< 3.5	< 2.8
11-08-05	PAMI -6389	< 0.3	1363 ± 118	< 3.6	< 3.9	< 3.1
12-06-05	PAMI -6935	< 0.3	1489 ± 106	< 2.5	< 3.6	< 1.8

PALISADES

Table 9. Food Crops, analyses for gross beta and gamma-emitting isotopes.
Collection: Semiannually, at the time of harvest.
Units: pCi/g wet

Location		J. Samo Farm	
Lab Code	PAVE-4656	PAVE-6098	
Date Collected	8/8/2005	10/10/2005	Req. LLD
Sample Type	Blueberries	Apples	
Mn-54	< 0.014	< 0.009	0.08
Fe-59	< 0.018	< 0.048	0.10
Co-58	< 0.010	< 0.015	0.08
Co-60	< 0.012	< 0.009	0.05
Zn-65	< 0.009	< 0.027	0.10
Zr-Nb-95	< 0.022	< 0.019	0.10
I-131	< 0.028	< 0.149	0.06 ^a
Cs-134	< 0.015	< 0.012	0.08
Cs-137	< 0.015	< 0.010	0.08

^a Required for broadleaf vegetation only.

PALISADES

Table 9. Food Crops, analyses for gross beta and gamma-emitting isotopes.
Collection: Semiannually, at the time of harvest.
Units: pCi/g wet

Location	Control Station		
Lab Code	PAVE-4657	PAVE-6099	
Date Collected	8/8/2005	10/10/2005	Req. LLD
Sample Type	Blueberries	Apples	
Mn-54	< 0.011	< 0.020	0.08
Fe-59	< 0.017	< 0.031	0.10
Co-58	< 0.013	< 0.015	0.08
Co-60	< 0.015	< 0.013	0.05
Zn-65	< 0.028	< 0.017	0.10
Zr-Nb-95	< 0.012	< 0.018	0.10
I-131	< 0.032	< 0.145	0.06 ^a
Cs-134	< 0.011	< 0.014	0.08
Cs-137	< 0.013	< 0.019	0.08

^a Required for broadleaf vegetation only.

PALISADES

Table 10. Fish, analyses for gross beta and gamma-emitting isotopes.
 Collection: Semiannually
 Units: pCi/g wet

Location		Discharge				
Lab Code	PAF-7118,9	PAF-7120	PAF-7121	PAF-7123		Req. LLD
Date Collected	4/6/2005	9/7/2005	9/21/2005	11/25/2005		
Sample Type	Brown Trout	Yellow Perch	Chinook Salmon	Whitefish		
Mn-54	< 0.034	< 0.020	< 0.016	< 0.015		0.13
Fe-59	< 1.452	< 0.212	< 0.188	< 0.051		0.26
Co-58	< 0.225	< 0.050	< 0.024	< 0.021		0.13
Co-60	< 0.020	< 0.018	< 0.010	< 0.013		0.13
Zn-65	< 0.048	< 0.029	< 0.024	< 0.018		0.26
Zr-Nb-95	< 2.162	< 0.170	< 0.167	< 0.041		0.10
Cs-134	< 0.015	< 0.016	< 0.013	< 0.015		0.13
Cs-137	< 0.018	< 0.016	0.065 ± 0.028	< 0.017		0.15

Location		Lake Ontario				
Lab Code	PAF-7126					Req. LLD
Date Collected	12/8/2005					
Sample Type	Perch					
Mn-54	< 0.013					0.13
Fe-59	< 0.052					0.26
Co-58	< 0.016					0.13
Co-60	< 0.015					0.13
Zn-65	< 0.020					0.26
Zr-Nb-95	< 0.014					0.10
Cs-134	< 0.015					0.13
Cs-137	< 0.014					0.15

Location		Ludington Pumped Storage Plant (Control)				
Lab Code	PAF-7122	PAF-7124	PAF-7125			Req. LLD
Date Collected	10/13/2005	12/8/2005	12/8/2005			
Sample Type	Chinook Salmon	Whitefish	Trout			
Mn-54	< 0.028	< 0.017	< 0.013			0.13
Fe-59	< 0.174	< 0.028	< 0.059			0.26
Co-58	< 0.037	< 0.015	< 0.014			0.13
Co-60	< 0.030	< 0.013	< 0.011			0.13
Zn-65	< 0.046	< 0.031	< 0.025			0.26
Zr-Nb-95	< 0.097	< 0.043	< 0.023			0.10
Cs-134	< 0.020	< 0.020	< 0.016			0.13
Cs-137	< 0.023	< 0.017	0.035 ± 0.020			0.15

PALISADES

Table 11. Bottom sediment, analyses for gamma-emitting isotopes.

Collection: Semiannually

Units: pCi/g dry

Location	Palisades North Property		
Lab Code	PABS-3124	PABS-6977,8	
Date Collected	4/28/2005	11/10/2005	Req. LLD
Mn-54	< 0.013	< 0.019	0.08
Fe-59	< 0.082	< 0.053	0.10
Co-58	< 0.020	< 0.028	0.08
Co-60	< 0.017	< 0.025	0.05
Zn-65	< 0.052	< 0.062	0.10
Zr-Nb-95	< 0.045	< 0.031	0.10
Cs-134	< 0.021	< 0.021	0.15
Cs-137	< 0.015	< 0.018	0.18

Location	Ludington Control		
Lab Code	PABS-7127		
Date Collected	12/8/2005		Req. LLD
Mn-54	< 0.025		0.08
Fe-59	< 0.091		0.10
Co-58	< 0.027		0.08
Co-60	< 0.026		0.05
Zn-65	< 0.087		0.10
Zr-Nb-95	< 0.025		0.10
Cs-134	< 0.037		0.15
Cs-137	< 0.024		0.18

PALISADES

Table 12.1. Liquid Radwaste, analyses for gross alpha, tritium, strontium-89, strontium-90, plutonium-239 and gamma emitting isotopes.

Collection: Monthly
Units: uCi/ml

Lab Code	Required LLD	NS ^a 01-31-05	NS ^a 02-28-05	PARW-1200 03-12-05
Date Collected	-			
Gross Alpha	1.0 E-07	-	-	9.1 ± 1.5 E-09
H-3	1.0 E-05	-	-	3.66 ± 0.01 E-01
Sr-89	5.0 E-08	-	-	< 2.3 E-09
Sr-90	5.0 E-08	-	-	7.7 ± 0.4 E-08
Pu-239	5.0 E-08	-	-	2.63 ± 1.78 E-10
Cr-51	5.0 E-07	-	-	< 7.31 E-08
Mn-54	5.0 E-07	-	-	< 3.94 E-08
Fe-59	5.0 E-07	-	-	< 2.53 E-08
Co-58	5.0 E-07	-	-	8.54 ± 0.20 E-07
Co-60	5.0 E-07	-	-	9.01 ± 0.17 E-07
Zn-65	5.0 E-07	-	-	< 2.64 E-08
Zr-95	5.0 E-07	-	-	< 1.93 E-08
Nb-95	5.0 E-07	-	-	< 1.34 E-08
Ag-110m	5.0 E-07	-	-	3.02 ± 0.63 E-08
Sb-124	5.0 E-07	-	-	< 1.40 E-08
Cs-134	5.0 E-07	-	-	< 1.17 E-08
Cs-137	5.0 E-07	-	-	1.14 ± 0.09 E-07
Ba-140	5.0 E-07	-	-	< 7.71 E-08
La-140	5.0 E-07	-	-	< 1.26 E-08
Ce-141	5.0 E-07	-	-	< 1.25 E-08
Ce-144	5.0 E-07	-	-	< 3.86 E-08

^a No sample received.

PALISADES

Table 12.1. Liquid Radwaste, analyses for gross alpha, tritium, strontium-89, strontium-90, plutonium-239 and gamma emitting isotopes.

Collection: Monthly
Units: uCi/ml

Lab Code	Required LLD	NS ^a 04-30-05	PARW-6345 05-31-05	NS ^a 06-30-05
Date Collected	-	04-30-05	05-31-05	06-30-05
Gross Alpha	1.0 E-07	-	4.6 ± 1.3 E-09	-
H-3	1.0 E-05	-	1.84 ± 0.01 E-01	-
Sr-89	5.0 E-08	-	< 1.9 E-08	-
Sr-90	5.0 E-08	-	9.8 ± 0.4 E-08	-
Pu-239	5.0 E-08	-	< 1.01 E-09	-
Cr-51	5.0 E-07	-	< 3.80 E-06	-
Mn-54	5.0 E-07	-	< 1.52 E-07	-
Fe-59	5.0 E-07	-	< 1.53 E-07	-
Co-58	5.0 E-07	-	7.51 ± 0.34 E-07	-
Co-60	5.0 E-07	-	1.05 ± 0.02 E-06	-
Zn-65	5.0 E-07	-	< 2.83 E-08	-
Zr-95	5.0 E-07	-	< 7.37 E-08	-
Nb-95	5.0 E-07	-	< 1.71 E-07	-
Ag-110m	5.0 E-07	-	< 1.75 E-08	-
Sb-124	5.0 E-07	-	< 8.26 E-08	-
Cs-134	5.0 E-07	-	1.60 ± 0.07 E-07	-
Cs-137	5.0 E-07	-	6.73 ± 0.12 E-07	-
Ba-140	5.0 E-07	-	ND ^b	-
La-140	5.0 E-07	-	ND ^b	-
Ce-141	5.0 E-07	-	< 3.92 E-07	-
Ce-144	5.0 E-07	-	< 6.85 E-08	-

^a No sample received.

^b "ND" = No data due to age of sample; sample received 10-28-05.

PALISADES

Table 12.1. Liquid Radwaste, analyses for gross alpha, tritium, strontium-89, strontium-90, plutonium-239 and gamma emitting isotopes.

Collection: Monthly
Units: uCi/ml

Lab Code	Required LLD	PARW-7586		NS ^a	PARW-6346	
Date Collected	-	07-05-05		08-31-05	09-26-05	
Gross Alpha	1.0 E-07	5.7 ± 1.6	E-09	-	2.1 ± 0.9	E-09
H-3	1.0 E-05	2.89 ± 0.01	E-01	-	4.03 ± 0.01	E-01
Sr-89	5.0 E-08	< 3.0	E-08	-	< 4.0	E-08
Sr-90	5.0 E-08	2.7 ± 0.1	E-07	-	8.6 ± 0.4	E-08
Pu-239	5.0 E-08	< 2.10	E-10	-	< 1.84	E-09
Cr-51	5.0 E-07	< 2.00	E-05	-	< 3.19	E-07
Mn-54	5.0 E-07	1.22 ± 0.04	E-06	-	< 3.00	E-07
Fe-59	5.0 E-07	< 7.11	E-07	-	< 6.54	E-08
Co-58	5.0 E-07	3.14 ± 0.09	E-06	-	1.38 ± 0.03	E-06
Co-60	5.0 E-07	3.27 ± 0.02	E-06	-	3.28 ± 0.05	E-06
Zn-65	5.0 E-07	1.02 ± 0.32	E-07	-	< 5.13	E-08
Zr-95	5.0 E-07	< 1.72	E-07	-	< 5.43	E-08
Nb-95	5.0 E-07	< 7.57	E-07	-	< 4.91	E-08
Ag-110m	5.0 E-07	< 5.71	E-08	-	2.46 ± 1.17	E-08
Sb-124	5.0 E-07	< 3.57	E-07	-	< 3.90	E-08
Cs-134	5.0 E-07	1.11 ± 0.01	E-06	-	1.81 ± 0.12	E-07
Cs-137	5.0 E-07	4.23 ± 0.03	E-06	-	6.51 ± 0.18	E-07
Ba-140	5.0 E-07	< 5.02	E-08 ^b	-	< 4.59	E-07
La-140	5.0 E-07	< 2.50	E-09 ^b	-	< 4.61	E-08
Ce-141	5.0 E-07	< 1.89	E-06	-	< 4.33	E-08
Ce-144	5.0 E-07	< 1.20	E-07	-	< 7.00	E-08

^a No sample received.

^b Not decay corrected; result at time of counting.

PALISADES

Table 12.1. Liquid Radwaste, analyses for gross alpha, tritium, strontium-89, strontium-90, plutonium-239 and gamma emitting isotopes.

Collection: Monthly
Units: uCi/ml

Lab Code	Required LLD	NS ^a	NS ^a	PARW-7587
Date Collected	-	10-31-05	11-30-05	12-16-05
Gross Alpha	1.0 E-07	-	-	2.7 ± 3.2 E-08
H-3	1.0 E-05	-	-	4.85 ± 0.01 E-01
Sr-89	5.0 E-08	-	-	< 3.3 E-09
Sr-90	5.0 E-08	-	-	5.0 ± 0.3 E-08
Pu-239	5.0 E-08	-	-	< 1.36 E-10
Cr-51	5.0 E-07	-	-	< 5.42 E-07
Mn-54	5.0 E-07	-	-	< 2.35 E-07
Fe-59	5.0 E-07	-	-	< 7.35 E-08
Co-58	5.0 E-07	-	-	8.75 ± 0.05 E-06
Co-60	5.0 E-07	-	-	1.01 ± 0.01 E-05
Zn-65	5.0 E-07	-	-	5.09 ± 0.40 E-07
Zr-95	5.0 E-07	-	-	< 6.40 E-08
Nb-95	5.0 E-07	-	-	< 5.91 E-08
Ag-110m	5.0 E-07	-	-	3.30 ± 0.20 E-07
Sb-124	5.0 E-07	-	-	< 4.72 E-08
Cs-134	5.0 E-07	-	-	7.67 ± 2.55 E-08
Cs-137	5.0 E-07	-	-	3.96 ± 0.20 E-07
Ba-140	5.0 E-07	-	-	< 1.12 E-06
La-140	5.0 E-07	-	-	< 1.36 E-07
Ce-141	5.0 E-07	-	-	< 7.28 E-08
Ce-144	5.0 E-07	-	-	2.25 ± 0.80 E-07

^a No sample received.

PALISADES

Table 12.2. Stack Filters, analyses for gross alpha, plutonium-239, strontium-89 and strontium-90.

Collection: Continuous, monthly exchange.

Units: pCi/filter

Location		Palisades			
Date Collected	Lab Code	Gross Alpha	Sr-89	Sr-90	Pu-239
<u>Required LLD</u>		<u>10</u>	<u>10</u>	<u>10</u>	<u>10</u>
01-31-05	PASP -637	1.2 ± 0.6	< 4.1	< 3.6	< 0.2
02-28-05	PASP -1199	< 0.7	< 2.4	< 2.7	< 0.3
03-30-05	PASP -6336	0.6 ± 0.4	< 83.5 ^a	< 3.6	< 0.2
04-27-05	PASP -6337	< 0.5	< 65.2 ^a	< 3.5	< 0.2
05-25-05	PASP -6338	< 0.4	< 31.5 ^a	< 3.0	< 0.2
06-29-05	PASP -6339	< 0.6	< 22.3 ^a	< 2.8	< 0.2
07-27-05	PASP -6340	< 0.5	< 14.2 ^a	< 2.7	< 0.1
08-31-05	PASP 6341,2	< 0.6	< 8.4 ^b	< 2.6	< 0.1
09-28-05	PASP -6343	< 0.5	< 6.0	< 2.9	< 0.1
10-31-05	PASP -7583	< 0.6	< 9.9	< 3.1	< 0.2
11-30-05	PASP -7584	< 0.6	< 6.9	< 3.0	< 0.3
12-31-05	PASP -7585	< 0.5	< 4.8	< 4.1	< 0.6

^a LLD not reached due to age of sample.

^b Not enough sample for strontium duplicate.

ATTACHMENT E

**ENVIRONMENTAL, INC, MIDWEST LABORATORY,
INTERLABORATORY COMPARISON PROGRAM RESULTS**

18 Pages Follow

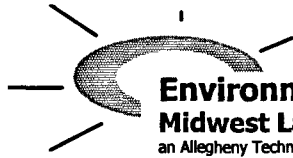

Environmental, Inc.
Midwest Laboratory
an Allegheny Technologies Co.

700 Landwehr Road • Northbrook, IL 60062-2310
ph. (847) 564-0700 • fax (847) 564-4517

APPENDIX A

INTERLABORATORY COMPARISON PROGRAM RESULTS

NOTE: Environmental Inc., Midwest Laboratory participates in intercomparison studies administered by Environmental Resources Associates, and serves as a replacement for studies conducted previously by the U.S. EPA Environmental Monitoring Systems Laboratory, Las Vegas, Nevada. Results are reported in Appendix A. TLD Intercomparison results, in-house spikes, blanks, duplicates and mixed analyte performance evaluation program results are also reported. Appendix A is updated four times a year; the complete Appendix is included in March, June, September and December monthly progress reports only.

January, 2005 through December, 2005

Appendix A

Interlaboratory Comparison Program Results

Environmental, Inc., Midwest Laboratory has participated in interlaboratory comparison (crosscheck) programs since the formulation of its quality control program in December 1971. These programs are operated by agencies which supply environmental type samples containing concentrations of radionuclides known to the issuing agency but not to participant laboratories. The purpose of such a program is to provide an independent check on a laboratory's analytical procedures and to alert it of any possible problems.

Participant laboratories measure the concentration of specified radionuclides and report them to the issuing agency. Several months later, the agency reports the known values to the participant laboratories and specifies control limits. Results consistently higher or lower than the known values or outside the control limits indicate a need to check the instruments or procedures used.

Results in Table A-1 were obtained through participation in the environmental sample crosscheck program administered by Environmental Resources Associates, serving as a replacement for studies conducted previously by the U.S. EPA Environmental Monitoring Systems Laboratory, Las Vegas, Nevada.

The results in Table A-2 list results for thermoluminescent dosimeters (TLDs), via International Intercomparison of Environmental Dosimeters, when available, and internal laboratory testing.

Table A-3 lists results of the analyses on in-house "spiked" samples for the past twelve months. All samples are prepared using NIST traceable sources. Data for previous years available upon request.

Table A-4 lists results of the analyses on in-house "blank" samples for the past twelve months. Data for previous years available upon request.

Table A-5 list results of the in-house "duplicate" program for the past twelve months. Acceptance is based on the difference of the results being less than the sum of the errors. Data for previous years available upon request.

The results in Table A-6 were obtained through participation in the Mixed Analyte Performance Evaluation Program.

Attachment A lists acceptance criteria for "spiked" samples.

Out-of-limit results are explained directly below the result.

Attachment A

ACCEPTANCE CRITERIA FOR "SPIKED" SAMPLES

LABORATORY PRECISION: ONE STANDARD DEVIATION VALUES FOR VARIOUS ANALYSES^a

Analysis	Level	One standard deviation for single determination
Gamma Emitters	5 to 100 pCi/liter or kg > 100 pCi/liter or kg	5.0 pCi/liter 5% of known value
Strontium-89 ^b	5 to 50 pCi/liter or kg > 50 pCi/liter or kg	5.0 pCi/liter 10% of known value
Strontium-90 ^b	2 to 30 pCi/liter or kg > 30 pCi/liter or kg	5.0 pCi/liter 10% of known value
Potassium-40	≥ 0.1 g/liter or kg	5% of known value
Gross alpha	≤ 20 pCi/liter > 20 pCi/liter	5.0 pCi/liter 25% of known value
Gross beta	≤ 100 pCi/liter > 100 pCi/liter	5.0 pCi/liter 5% of known value
Tritium	≤ 4,000 pCi/liter > 4,000 pCi/liter	± 1σ = (pCi/liter) = 169.85 x (known) ^{0.0933} 10% of known value
Radium-226,-228	≥ 0.1 pCi/liter	15% of known value
Plutonium	≥ 0.1 pCi/liter, gram, or sample	10% of known value
Iodine-131, Iodine-129 ^b	≤ 55 pCi/liter > 55 pCi/liter	6.0 pCi/liter 10% of known value
Uranium-238, Nickel-63 ^b Technetium-99 ^b	≤ 35 pCi/liter > 35 pCi/liter	6.0 pCi/liter 15% of known value
Iron-55 ^b	50 to 100 pCi/liter > 100 pCi/liter	10 pCi/liter 10% of known value
Others ^b	---	20% of known value

^a From EPA publication, "Environmental Radioactivity Laboratory Intercomparison Studies Program, Fiscal Year, 1981-1982, EPA-600/4-81-004.

^b Laboratory limit.

TABLE A-1. Interlaboratory Comparison Crosscheck program, Environmental Resource Associates (ERA)^a.

Lab Code	Date	Analysis	Concentration (pCi/L)			Acceptance
			Laboratory Result ^b	ERA Result ^c	Control Limits	
STW-1051	02/15/05	Sr-89	28.0 ± 1.2	29.4	20.7 - 38.1	Pass
STW-1051	02/15/05	Sr-90	25.1 ± 0.7	24.4	15.7 - 33.1	Pass
STW-1052	02/15/05	Ba-133	52.9 ± 2.8	53.4	44.2 - 62.6	Pass
STW-1052	02/15/05	Co-60	54.4 ± 0.4	56.6	47.9 - 65.3	Pass
STW-1052	02/15/05	Cs-134	67.7 ± 1.8	64.9	56.2 - 73.6	Pass
STW-1052	02/15/05	Cs-137	39.6 ± 1.8	40.2	31.5 - 48.9	Pass
STW-1052	02/15/05	Zn-65	159.7 ± 3.0	161.0	133.0 - 189.0	Pass
STW-1053	02/15/05	Gr. Alpha	55.1 ± 1.8	67.9	38.5 - 97.3	Pass
STW-1053	02/15/05	Gr. Beta	46.8 ± 1.3	51.1	38.5 - 97.3	Pass
STW-1054	02/15/05	Ra-226	13.7 ± 1.5	14.1	10.4 - 17.8	Pass
STW-1054	02/15/05	Ra-228	13.3 ± 0.6	13.7	7.8 - 19.6	Pass
STW-1054	02/15/05	Uranium	5.1 ± 0.2	5.0	0.0 - 10.2	Pass
STW-1055	05/17/05	Sr-89	45.1 ± 4.1	41.3	32.6 - 50.0	Pass
STW-1055	05/17/05	Sr-90	7.5 ± 0.9	5.9	0.0 - 14.6	Pass
STW-1056	05/17/05	Ba-133	87.1 ± 2.0	88.4	73.1 - 104.0	Pass
STW-1056	05/17/05	Co-60	38.4 ± 0.8	37.0	28.3 - 45.7	Pass
STW-1056	05/17/05	Cs-134	75.3 ± 0.7	78.6	69.9 - 87.3	Pass
STW-1056	05/17/05	Cs-137	201.0 ± 8.4	194.0	184.0 - 218.0	Pass
STW-1056	05/17/05	Zn-65	130.0 ± 6.7	118.0	97.6 - 138.0	Pass
STW-1057	05/17/05	Gr. Alpha	42.7 ± 2.9	37.0	21.0 - 53.0	Pass
STW-1057	05/17/05	Gr. Beta	34.0 ± 0.4	34.2	25.5 - 42.9	Pass
STW-1058	05/17/05	I-131	14.7 ± 0.5	15.5	10.3 - 20.7	Pass
STW-1059	05/17/05	Ra-226	6.6 ± 0.1	7.6	5.6 - 9.5	Pass
STW-1059	05/17/05	Ra-228	19.3 ± 0.7	18.9	10.7 - 27.1	Pass
STW-1059	05/17/05	Uranium	9.6 ± 0.1	10.1	4.9 - 15.3	Pass
STW-1060	05/17/05	H-3	24100.0 ± 109.0	24400.0	20200.0 - 28600.0	Pass
STW-1067	08/16/05	Sr-89	29.1 ± 3.0	28.0	19.3 - 36.7	Pass
STW-1067	08/16/05	Sr-90	36.0 ± 0.6	33.8	25.1 - 42.5	Pass
STW-1068	08/16/05	Ba-133	107.0 ± 1.7	106.0	87.7 - 124.0	Pass
STW-1068	08/16/05	Co-60	15.2 ± 0.2	13.5	4.8 - 22.2	Pass
STW-1068	08/16/05	Cs-134	89.1 ± 0.3	92.1	83.4 - 101.0	Pass
STW-1068	08/16/05	Cs-137	72.1 ± 1.0	72.7	64.0 - 81.4	Pass
STW-1068	08/16/05	Zn-65	67.4 ± 1.4	65.7	54.3 - 77.1	Pass
STW-1069	08/16/05	Gr. Alpha	44.3 ± 1.5	55.7	31.6 - 79.8	Pass
STW-1069	08/16/05	Gr. Beta	58.4 ± 2.1	61.3	44.0 - 78.6	Pass
STW-1070	08/16/05	Ra-226	16.6 ± 1.5	16.6	12.3 - 20.9	Pass
STW-1070	08/16/05	Ra-228	6.2 ± 0.3	6.2	3.5 - 8.9	Pass
STW-1070	08/16/05	Uranium	4.5 ± 0.1	4.5	0.0 - 9.7	Pass

TABLE A-1. Interlaboratory Comparison Crosscheck program, Environmental Resource Associates (ERA)^a.

Lab Code	Date	Analysis	Concentration (pCi/L)			Acceptance
			Laboratory Result ^b	ERA Result ^c	Control Limits	
STW-1072	11/15/05	Sr-89	20.6 ± 0.4	19.0	10.3 - 27.7	Pass
STW-1072	11/15/05	Sr-90	15.0 ± 0.3	16.0	7.3 - 24.7	Pass
STW-1073	11/15/05	Ba-133	31.8 ± 1.8	31.2	22.5 - 39.9	Pass
STW-1073	11/15/05	Co-60	85.0 ± 1.4	84.1	75.4 - 92.8	Pass
STW-1073	11/15/05	Cs-134	37.2 ± 2.1	33.9	25.2 - 42.6	Pass
STW-1073	11/15/05	Cs-137	27.8 ± 0.7	28.3	19.6 - 37.0	Pass
STW-1073	11/15/05	Zn-65	109.0 ± 1.0	105.0	86.8 - 123.0	Pass
STW-1074 ^d	11/15/05	Gr. Alpha	41.1 ± 1.2	23.3	13.2 - 33.4	Fail
STW-1074	11/15/05	Gr. Beta	42.7 ± 0.5	39.1	30.4 - 47.8	Pass
STW-1075	11/15/05	I-131	20.5 ± 0.6	17.4	12.2 - 22.6	Pass
STW-1076	11/15/05	Ra-226	7.8 ± 0.6	8.3	6.2 - 10.5	Pass
STW-1076 ^e	11/15/05	Ra-228	5.5 ± 0.6	3.5	2.0 - 5.0	Fail
STW-1076	11/15/05	Uranium	15.5 ± 0.3	16.1	10.9 - 21.3	Pass
STW-1077	11/15/05	H-3	12500.0 ± 238.0	12200.0	10100.0 - 14300.0	Pass

^a Results obtained by Environmental, Inc., Midwest Laboratory as a participant in the crosscheck program for proficiency testing in drinking water conducted by Environmental Resources Associates (ERA).

^b Unless otherwise indicated, the laboratory result is given as the mean ± standard deviation for three determinations.

^c Results are presented as the known values, expected laboratory precision (1 sigma, 1 determination) and control limits as provided by ERA.

^d The original samples were calculated using an Am-241 efficiency. The samples were spiked with Th-232. Samples were recounted and calculated using the Th-232 efficiency. Results of the recount: 27.01 ± 2.35 pCi/L.

^e Decay of short-lived radium daughters contributed to a higher counting rate. Delay of counting for 100 minutes provided better results. The reported result was the average of the first cycle of 100 minutes, the average of the second cycle counts was 4.01 pCi/L

TABLE A-2. Crosscheck program results; Thermoluminescent Dosimetry, (TLD, CaSO₄: Dy Cards).

Lab Code	Date	Description	Known Value	mR		Acceptance
				Lab Result ± 2 sigma	Control Limits	
<u>Environmental, Inc.</u>						
2005-1	4/4/2005	30 cm	55.01	64.02 ± 2.86	38.51 - 71.51	Pass
2005-1	4/4/2005	60 cm	13.75	15.43 ± 1.02	9.63 - 17.88	Pass
2005-1	4/4/2005	60 cm	13.75	14.98 ± 0.80	9.63 - 17.88	Pass
2005-1	4/4/2005	90 cm	6.11	6.24 ± 0.16	4.28 - 7.94	Pass
2005-1	4/4/2005	90 cm	6.11	5.45 ± 0.48	4.28 - 7.94	Pass
2005-1	4/4/2005	120 cm	3.44	3.50 ± 0.35	2.41 - 4.47	Pass
2005-1	4/4/2005	120 cm	3.44	3.15 ± 0.18	2.41 - 4.47	Pass
2005-1	4/4/2005	150 cm	2.2	2.31 ± 0.25	1.54 - 2.86	Pass
2005-1	4/4/2005	180 cm	1.53	1.65 ± 0.41	1.07 - 1.99	Pass
<u>Environmental, Inc.</u>						
2005-2	9/12/2005	30 cm	54.84	59.30 ± 2.66	38.39 - 71.29	Pass
2005-2	9/12/2005	60 cm	13.71	17.55 ± 1.30	9.60 - 17.82	Pass
2005-2	9/12/2005	75 cm	8.77	8.24 ± 0.38	6.14 - 11.40	Pass
2005-2	9/12/2005	90 cm	6.09	5.94 ± 0.49	4.26 - 7.92	Pass
2005-2	9/12/2005	90 cm	6.09	5.93 ± 0.37	4.26 - 7.92	Pass
2005-2	9/12/2005	120 cm	3.43	3.42 ± 0.18	2.40 - 4.46	Pass
2005-2	9/12/2005	150 cm	2.19	1.71 ± 0.14	1.53 - 2.85	Pass
2005-2	9/12/2005	150 cm	2.19	1.87 ± 0.27	1.53 - 2.85	Pass
2005-2	9/12/2005	180 cm	1.52	1.58 ± 0.99	1.06 - 1.98	Pass

TABLE A-3. In-House "Spike" Samples

Lab Code ^b	Date	Analysis	Concentration (pCi/L) ^a			Acceptance
			Laboratory results 2s, n=1 ^c	Known Activity	Control Limits ^d	
W-11105	1/11/2005	Gr. Alpha	24.05 ± 1.01	20.08	10.04 - 30.12	Pass
W-11105	1/11/2005	Gr. Beta	61.59 ± 1.11	65.70	55.70 - 75.70	Pass
SPW-764	2/18/2005	H-3	77595.00 ± 764.00	80543.00	64434.40 - 96651.60	Pass
SPAP-766	2/18/2005	Gr. Beta	416.08 ± 5.52	463.00	370.40 - 509.30	Pass
STW-2887	2/28/2005	Tc-99	32.91 ± 1.23	32.98	20.98 - 44.98	Pass
W-30105	3/1/2005	Gr. Alpha	25.22 ± 0.45	20.08	10.04 - 30.12	Pass
W-30105	3/1/2005	Gr. Beta	62.27 ± 0.48	65.73	55.73 - 75.73	Pass
SPW-1836	4/15/2005	I-131	109.79 ± 0.94	106.30	85.04 - 127.56	Pass
SPW-1836	4/15/2005	I-131(G)	110.25 ± 9.68	106.30	95.67 - 116.93	Pass
SPMI-1838	4/15/2005	Cs-134	25.94 ± 1.28	26.60	16.60 - 36.60	Pass
SPMI-1838	4/15/2005	Cs-137	59.31 ± 3.66	60.90	50.90 - 70.90	Pass
SPMI-1838	4/15/2005	I-131	97.71 ± 0.81	106.30	85.04 - 127.56	Pass
SPMI-1838	4/15/2005	I-131(G)	109.45 ± 3.06	106.30	95.67 - 116.93	Pass
SPMI-1838	4/15/2005	Sr-89	104.44 ± 2.89	108.20	86.56 - 129.84	Pass
SPMI-1838	4/15/2005	Sr-90	8.97 ± 0.79	7.53	0.00 - 17.53	Pass
SPVE-1932	4/18/2005	I-131(G)	1.00 ± 0.04	0.73	0.44 - 1.02	Pass
SPCH-1935	4/18/2005	I-131	382.40 ± 14.95	328.64	262.91 - 394.37	Pass
SPAP-1966	4/18/2005	Cs-134	52.10 ± 7.27	53.35	43.35 - 63.35	Pass
SPAP-1966	4/18/2005	Cs-134	57.28 ± 13.47	53.35	43.35 - 63.35	Pass
SPAP-1966	4/18/2005	Cs-137	124.68 ± 18.41	121.77	109.59 - 133.95	Pass
SPAP-1968	4/18/2005	Cs-134	52.10 ± 7.27	53.35	43.35 - 63.35	Pass
SPAP-1968	4/18/2005	Cs-137	116.79 ± 14.00	121.77	109.59 - 133.95	Pass
SPW-2098	4/26/2005	Fe-55	2565.20 ± 63.66	3017.60	2414.08 - 3621.12	Pass
SPW-2922	5/31/2005	Cs-134	27.01 ± 1.09	25.54	15.54 - 35.54	Pass
SPW-2922	5/31/2005	Cs-134	65.38 ± 2.92	60.71	50.71 - 70.71	Pass
SPW-2922	5/31/2005	Sr-89	107.90 ± 3.60	113.90	91.12 - 136.68	Pass
SPW-2922	5/31/2005	Sr-90	11.11 ± 1.13	6.90	0.00 - 16.90	Pass
SPAP-2892	6/1/2005	Gr. Beta	420.32 ± 5.55	448.00	358.40 - 492.80	Pass
SPW-2895	6/1/2005	H-3	75271.00 ± 724.00	78676.00	62940.80 - 94411.20	Pass
w-60105	6/1/2005	Gr. Alpha	23.69 ± 0.52	20.08	10.04 - 30.12	Pass
w-60105	6/1/2005	Gr. Beta	60.08 ± 0.57	65.73	55.73 - 75.73	Pass
SPF-3089	6/7/2005	Cs-134	1.08 ± 0.05	1.02	0.61 - 1.43	Pass
SPF-3089	6/7/2005	Cs-137	2.54 ± 0.10	2.43	1.46 - 3.40	Pass
SPW-	7/1/2005	Ni-63	20.57 ± 1.10	16.75	10.05 - 23.45	Pass
SPW-47731	8/24/2005	C-14	2112.30 ± 9.13	2370.80	1422.48 - 3319.12	Pass
SPW-47732	8/24/2005	C-14	2294.10 ± 10.37	2370.80	1422.48 - 3319.12	Pass
SPW-4775	8/24/2005	Fe-55	2633.50 ± 62.40	2777.50	2222.00 - 3333.00	Pass
SPMI-4834	8/30/2005	Cs-134	49.27 ± 4.68	47.02	37.02 - 57.02	Pass
SPMI-4834	8/30/2005	Cs-137	58.17 ± 8.18	60.37	50.37 - 70.37	Pass
SPMI-4834	8/30/2005	Sr-89	66.39 ± 3.13	65.90	52.72 - 79.08	Pass
SPMI-4834	8/30/2005	Sr-90	11.15 ± 1.13	9.60	0.00 - 19.60	Pass

TABLE A-3. In-House "Spike" Samples

Lab Code	Date	Analysis	Concentration (pCi/L)			Acceptance
			Laboratory results 2s, n=1 ^b	Known Activity	Control Limits ^c	
SPW-4836	8/30/2005	Cs-134	47.35 ± 5.19	47.02	37.02 - 57.02	Pass
SPW-4836	8/30/2005	Cs-137	62.91 ± 9.08	60.37	50.37 - 70.37	Pass
SPW-4836	8/30/2005	Sr-89	11.04 ± 0.98	9.60	0.00 - 19.60	Pass
SPW-4836	8/30/2005	Sr-90	65.89 ± 2.79	65.90	52.72 - 79.08	Pass
SPW-5014	8/30/2005	H-3	77518.20 ± 753.80	77602.52	62082.02 - 93123.02	Pass
W-90705	9/7/2005	Gr. Alpha	24.61 ± 0.48	20.08	10.04 - 30.12	Pass
W-90705	9/7/2005	Gr. Beta	58.35 ± 0.49	65.73	55.73 - 75.73	Pass
SPW-5237	9/22/2005	C-14	2387.40 ± 11.00	2370.80	1422.48 - 3319.12	Pass
SPW-5508	9/26/2005	Ni-63	20.64 ± 1.23	16.70	10.02 - 23.38	Pass
SPW-6019	10/24/2005	Tc-99	547.99 ± 6.69	539.22	377.45 - 700.99	Pass
SPF-6293	11/4/2005	Cs-134	941.30 ± 44.10	886.00	797.40 - 974.60	Pass
SPF-6293	11/4/2005	Cs-137	2570.40 ± 105.30	2400.00	2160.00 - 2640.00	Pass
SPAP-6309	11/7/2005	Cs-134	41.24 ± 1.91	44.03	34.03 - 54.03	Pass
SPAP-6309	11/7/2005	Cs-137	114.03 ± 5.01	120.24	108.22 - 132.26	Pass
SPAP-6311	11/7/2005	Gr. Beta	1.58 ± 0.02	1.42	1.14 - 11.42	Pass
SPW-6451	11/10/2005	H-3	77126.00 ± 747.00	76749.00	61399.20 - 92098.80	Pass
W-120105	12/1/2005	Gr. Alpha	25.16 ± 0.45	20.08	10.04 - 30.12	Pass
W-120105	12/1/2005	Gr. Beta	74.58 ± 0.81	65.73	55.73 - 75.73	Pass
SPW-7440	12/30/2005	Cs-134	42.67 ± 4.22	42.03	32.03 - 52.03	Pass
SPW-7440	12/30/2005	Cs-137	61.19 ± 7.20	59.91	49.91 - 69.91	Pass
SPMI-7442	12/31/2005	Cs-134	40.41 ± 5.66	42.03	32.03 - 52.03	Pass
SPMI-7442	12/31/2005	Cs-137	60.05 ± 7.80	59.91	49.91 - 69.91	Pass

^a Liquid sample results are reported in pCi/Liter, air filters(pCi/filter), charcoal (pCi/m³), and solid samples (pCi/g).

^b Laboratory codes as follows: W (water), MI (milk), AP (air filter), SO (soil), VE (vegetation), CH (charcoal canister), F (fish).

^c Results are based on single determinations.

^d Control limits are based on Attachment A, Page A2 of this report.

NOTE: For fish, Jello is used for the Spike matrix. For Vegetation, cabbage is used for the Spike matrix.

TABLE A-4. In-House "Blank" Samples

Lab Code	Sample Type	Date	Analysis	Concentration (pCi/L) ^a		
				Laboratory results (4.66σ)		Acceptance Criteria (4.66 σ)
				LLD	Activity ^b	
W-11105	water	1/11/2005	Gr. Alpha	0.055	0.00 ± 0.038	1
W-11105	water	1/11/2005	Gr. Beta	0.15	-0.016 ± 0.10	3.2
SPW-765	water	2/18/2005	H-3	165.8	7.4 ± 82.5	200
SPAP-766	Air Filter	2/18/2005	Gr. Beta	0.72	0.29 ± 0.48	3.2
STW-2888	water	2/28/2005	Tc-99	1.32	0.45 ± 0.81	10
W-30105	water	3/1/2005	Gr. Alpha	0.067	-0.007 ± 0.043	1
W-30105	water	3/1/2005	Gr. Beta	0.18	-0.04 ± 0.11	3.2
SPW-1837	water	4/15/2005	Cs-134	4.66		10
SPW-1837	water	4/15/2005	Cs-137	5.38		10
SPW-1837	water	4/15/2005	I-131	0.30	-0.13 ± 0.16	0.5
SPW-1837	water	4/15/2005	I-131(G)	6.56		20
SPMI-1839	Milk	4/15/2005	I-131	0.26	-0.083 ± 0.14	0.5
SPMI-1839	Milk	4/15/2005	Sr-89	0.54	-0.069 ± 0.56	5
SPMI-1839	Milk	4/15/2005	Sr-90	0.53	0.88 ± 0.34	1
SPCH-1934	Charcoal	4/18/2005	I-131(G)	2.34		9.6
SPW-2097	water	4/26/2005	Fe-55	859.0	96.1 ± 528.4	1000
SPW-2923	water	5/31/2005	Cs-134	3.29		10
SPW-2923	water	5/31/2005	Cs-137	3.87		10
SPW-2896	water	6/1/2005	H-3	138.30	48.1 ± 85.9	200
w-60105	water	6/1/2005	Gr. Alpha	0.061	0.002 ± 0.043	1
w-60105	water	6/1/2005	Gr. Beta	0.16	0.056 ± 0.11	3.2
SPF-3090	Fish	6/7/2005	Cs-134	15.69		100
SPF-3090	Fish	6/7/2005	Cs-137	11.71		100
SPW-	water	7/1/2005	Ni-63	1.60	0.79 ± 0.99	20
SPW-4774	water	8/24/2005	C-14	12.18	2.84 ± 6.45	200
SPW-4776	water	8/24/2005	Fe-55	833	275 ± 525	1000
SPMI-4835	Milk	8/30/2005	Co-60	4.42		10
SPMI-4835	Milk	8/30/2005	Cs-134	4.18		10
SPMI-4835	Milk	8/30/2005	Cs-137	6.25		10
SPMI-4835	Milk	8/30/2005	I-131(G)	5.37		20
SPMI-4835	Milk	8/30/2005	Sr-89	0.66	-0.23 ± 0.65	5
SPMI-4835 ^d	Milk	8/30/2005	Sr-90	0.66	1.02 ± 0.41	1
SPW-4837	water	8/30/2005	Co-60	2.48		10
SPW-4837	water	8/30/2005	Cs-134	3.85		10
SPW-4837	water	8/30/2005	Cs-137	3.00		10
SPW-4837	water	8/30/2005	Sr-89	0.63	0.25 ± 0.53	5
SPW-4837	water	8/30/2005	Sr-90	0.63	-0.035 ± 0.29	1
SPW-5015	water	8/30/2005	H-3	142.8	168 ± 93	200
SPW-5238	water	9/22/2005	C-14	17.10	3.02 ± 9.04	200

TABLE A-4. In-House "Blank" Samples

Lab Code	Sample Type	Date	Analysis	Concentration (pCi/L) ^a		
				Laboratory results (4.66σ)		Acceptance Criteria (4.66 σ)
				LLD	Activity ^b	
W-90705	water	9/7/2005	Gr. Alpha	0.056	0.034 ± 0.04	1
W-90705	water	9/7/2005	Gr. Beta	0.16	0.082 ± 0.11	3.2
SPW-5238	water	9/22/2005	C-14	17.10	3.02 ± 9.04	200
SPW-5509	water	9/26/2005	Ni-63	1.25	1.23 ± 0.79	20
SPW-6020	water	10/24/2005	Tc-99	4.81	-1.75 ± 2.90	10
SPF-6294	Fish	11/4/2005	Cs-134	18.60		100
SPF-6294	Fish	11/4/2005	Cs-137	12.99		100
SPAP-6310	Air Filter	11/7/2005	Cs-134	3.23		100
SPAP-6310	Air Filter	11/7/2005	Cs-137	3.86		100
SPAP-6312	Air Filter	11/7/2005	Gr. Beta	1.22	-0.64 ± 0.64	3.2
W-120105	water	12/1/2005	Gr. Alpha	0.05	0.033 ± 0.04	1
W-120105	water	12/1/2005	Gr. Beta	0.15	-0.043 ± 0.11	3.2
SPMI-7419	Milk	12/22/2005	Co-60	7.24		10
SPMI-7419	Milk	12/22/2005	Cs-137	5.61		10
SPMI-7419	Milk	12/22/2005	I-131(G)	10.96		20
SPW-7421	water	12/22/2005	Co-60	2.43		10
SPW-7421	water	12/22/2005	Cs-137	3.12		10
SPW-7441	water	12/30/2005	Cs-134	4.25		10
SPW-7441	water	12/30/2005	Cs-137	1.63		10
SPMI-7443	Milk	12/30/2005	Cs-134	4.74		10
SPMI-7443	Milk	12/30/2005	Cs-137	8.53		10

^a Liquid sample results are reported in pCi/Liter, air filters (pCi/filter), charcoal (pCi/charcoal canister), and solid samples (pCi/g).

^b Activity reported is a net activity result. For gamma spectroscopic analysis, activity detected below the LLD value is not reported

^c I-131(G); iodine-131 as analyzed by gamma spectroscopy.

^d Low levels of Sr-90 are still detected in the environment. A concentration of (1-5 pCi/L) in milk is not unusual.

TABLE A-5. In-House "Duplicate" Samples

Lab Code	Date	Analysis	Concentration (pCi/L) ^a			Acceptance
			First Result	Second Result	Averaged Result	
SW-62, 63	1/3/2005	Gr. Beta	3.01 ± 0.57	2.39 ± 0.58	2.70 ± 0.41	Pass
SW-62, 63	1/3/2005	K-40	2.00 ± 0.20	2.10 ± 0.20	2.05 ± 0.14	Pass
CF-95, 96	1/3/2005	Gr. Beta	6.26 ± 0.23	6.28 ± 0.23	6.27 ± 0.16	Pass
CF-95, 96	1/3/2005	K-40	5.68 ± 0.59	5.37 ± 0.48	5.53 ± 0.38	Pass
AP-791, 792	1/14/2005	Be-7	0.057 ± 0.017	0.07 ± 0.04	0.06 ± 0.02	Pass
WW-353, 354	1/19/2005	Gr. Beta	8.37 ± 1.21	10.28 ± 1.34	9.32 ± 0.90	Pass
SO-383, 384	1/19/2005	H-3	453.50 ± 107.20	417.90 ± 106.00	435.70 ± 75.38	Pass
LW-431, 432	1/27/2005	Gr. Beta	2.45 ± 0.54	2.20 ± 0.54	2.33 ± 0.38	Pass
MI-486, 487	2/1/2005	K-40	1319.40 ± 163.60	1177.20 ± 179.70	1248.30 ± 121.51	Pass
SW-511, 512	2/1/2005	I-131	0.37 ± 0.22	0.44 ± 0.23	0.40 ± 0.16	Pass
TD-628, 629	2/1/2005	H-3	489663 ± 1918	491225 ± 1915	490444 ± 1355	Pass
DW-538, 539	2/3/2005	Gr. Beta	3.93 ± 1.18	3.62 ± 1.10	3.78 ± 0.81	Pass
MI-564, 565	2/8/2005	K-40	1316.20 ± 171.10	1292.60 ± 154.40	1304.40 ± 115.23	Pass
DW-50134, 5	2/11/2005	Gr. Beta	18.41 ± 0.98	16.76 ± 0.98	17.59 ± 0.69	Pass
SWU-893, 894	2/22/2005	Gr. Beta	4.00 ± 0.96	4.20 ± 0.72	4.10 ± 0.60	Pass
SW-925, 926	2/25/2005	Gr. Beta	5.97 ± 1.51	6.14 ± 1.55	6.06 ± 1.08	Pass
SW-950, 951	3/1/2005	Gr. Beta	0.92 ± 0.27	1.21 ± 0.27	1.07 ± 0.19	Pass
SW-950, 951	3/1/2005	Gr. Beta	2.06 ± 0.40	2.29 ± 0.44	2.18 ± 0.30	Pass
SW-973, 974	3/1/2005	I-131	1.08 ± 0.19	0.92 ± 0.18	1.00 ± 0.13	Pass
DW-50248, 9	3/16/2005	Gr. Alpha	5.27 ± 1.06	4.17 ± 0.90	4.72 ± 0.70	Pass
DW-1264, 1265	3/19/2005	I-131	0.54 ± 0.21	0.73 ± 0.20	0.63 ± 0.15	Pass
AP-1955, 1956	3/28/2005	Be-7	0.071 ± 0.009	0.071 ± 0.009	0.071 ± 0.006	Pass
AP-1890, 1891	3/29/2005	Be-7	0.060 ± 0.013	0.069 ± 0.013	0.065 ± 0.009	Pass
AP-2025, 2026	3/29/2005	Be-7	0.063 ± 0.012	0.071 ± 0.011	0.067 ± 0.008	Pass
MI-1346, 1347	3/30/2005	K-40	1252.80 ± 120.50	1334.10 ± 106.60	1293.45 ± 80.44	Pass
AP-2048, 2049	3/30/2005	Be-7	0.075 ± 0.018	0.071 ± 0.015	0.073 ± 0.012	Pass
AP-2081, 2082	3/30/2005	Be-7	0.073 ± 0.016	0.061 ± 0.018	0.067 ± 0.012	Pass
SWU-1521, 1522	3/31/2005	Gr. Beta	2.83 ± 1.16	3.46 ± 1.23	3.14 ± 0.85	Pass
WW-1738, 1739	4/5/2005	Gr. Beta	11.44 ± 1.17	11.14 ± 1.62	11.29 ± 1.00	Pass
SW-1857, 1858	4/13/2005	Gr. Beta	7.04 ± 1.71	9.96 ± 1.65	8.50 ± 1.19	Pass
LW-1911, 1912	4/14/2005	Gr. Beta	2.50 ± 0.63	3.23 ± 0.67	2.86 ± 0.46	Pass
F-1976, 1977	4/18/2005	K-40	3.09 ± 0.60	3.33 ± 0.40	3.21 ± 0.36	Pass
MI-2111, 2112	4/26/2005	K-40	1291.50 ± 177.90	1323.70 ± 108.80	1307.60 ± 104.27	Pass
SWU-2158, 2159	4/26/2005	Gr. Beta	3.69 ± 0.74	3.54 ± 0.66	3.62 ± 0.50	Pass
DW-2349, 2350	4/29/2005	I-131	0.58 ± 0.27	0.49 ± 0.27	0.53 ± 0.19	Pass
SO-2305, 2306	5/2/2005	Cs-137	0.11 ± 0.05	0.11 ± 0.04	0.11 ± 0.03	Pass
SO-2305, 2306	5/2/2005	Gr. Alpha	7.55 ± 2.88	12.41 ± 3.38	9.98 ± 2.22	Pass
SO-2305, 2306	5/2/2005	Gr. Beta	28.74 ± 2.57	28.17 ± 2.52	28.46 ± 1.80	Pass
SO-2305, 2306	5/2/2005	K-40	21.51 ± 1.22	21.42 ± 1.24	21.47 ± 0.87	Pass
SO-2305, 2306	5/2/2005	Sr-90	32.90 ± 9.90	29.60 ± 13.90	31.25 ± 8.53	Pass
MI-2260, 2261	5/3/2005	K-40	1028.10 ± 99.36	1206.70 ± 118.50	1117.40 ± 77.32	Pass
F-2630, 2631	5/5/2005	K-40	3.08 ± 0.46	3.04 ± 0.51	3.06 ± 0.34	Pass
VE-2502, 2503	5/10/2005	Gr. Alpha	0.06 ± 0.03	0.07 ± 0.04	0.07 ± 0.03	Pass

TABLE A-5. In-House "Duplicate" Samples

Lab Code	Date	Analysis	Concentration (pCi/L) ^a			Acceptance
			First Result	Second Result	Averaged Result	
VE-2502, 2503	5/10/2005	Gr. Beta	3.81 ± 0.10	3.86 ± 0.10	3.83 ± 0.07	Pass
VE-2502, 2503	5/10/2005	K-40	3.79 ± 0.40	4.30 ± 0.59	4.04 ± 0.36	Pass
G-2546, 2547	5/11/2005	Be-7	0.81 ± 0.39	1.25 ± 0.38	1.03 ± 0.27	Pass
G-2546, 2547	5/11/2005	K-40	9.43 ± 1.00	7.96 ± 0.85	8.70 ± 0.66	Pass
SS-2787, 2788	5/18/2005	Cs-137	0.13 ± 0.04	0.14 ± 0.05	0.13 ± 0.03	Pass
SS-2787, 2788	5/18/2005	K-40	12.44 ± 0.76	13.33 ± 0.83	12.88 ± 0.56	Pass
SO-3056, 3057	5/19/2005	Cs-137	0.18 ± 0.04	0.17 ± 0.01	0.18 ± 0.02	Pass
SO-3056, 3057 ^b	5/19/2005	K-40	20.06 ± 1.10	21.73 ± 0.36	20.90 ± 0.58	Fail
SS-3175, 3176	5/23/2005	K-40	6.06 ± 0.44	5.96 ± 0.61	6.01 ± 0.38	Pass
SO-2865, 2866	5/25/2005	Cs-137	0.18 ± 0.04	0.18 ± 0.03	0.18 ± 0.02	Pass
SO-2865, 2866	5/25/2005	Gr. Beta	32.95 ± 2.48	33.88 ± 2.36	33.41 ± 1.71	Pass
SO-2865, 2866	5/25/2005	K-40	21.93 ± 0.97	22.32 ± 0.98	22.13 ± 0.69	Pass
DW-2935, 2936	5/27/2005	I-131	0.51 ± 0.34	0.56 ± 0.30	0.53 ± 0.23	Pass
SWU-3103, 3104	6/1/2005	Gr. Beta	3.29 ± 0.49	3.75 ± 0.66	3.52 ± 0.41	Pass
G-2958, 2959	6/1/2005	Be-7	1.06 ± 0.40	1.21 ± 0.28	1.14 ± 0.24	Pass
G-2958, 2959 ^b	6/1/2005	Gr. Beta	8.06 ± 0.07	7.79 ± 0.07	7.93 ± 0.05	Fail
G-2958, 2959	6/1/2005	K-40	5.93 ± 0.73	6.05 ± 0.28	5.99 ± 0.39	Pass
BS-4089, 4090	6/3/2005	Co-60	0.11 ± 0.02	0.10 ± 0.02	0.11 ± 0.02	Pass
BS-4089, 4090	6/3/2005	Cs-137	0.60 ± 0.05	0.62 ± 0.05	0.61 ± 0.04	Pass
DW-50527, 8	6/8/2005	Gr. Alpha	11.58 ± 1.31	13.52 ± 1.43	12.55 ± 0.97	Pass
VE-3278, 3279	6/13/2005	K-40	6.34 ± 0.59	7.29 ± 0.68	6.81 ± 0.45	Pass
MI-3299, 3300	6/15/2005	K-40	1215.40 ± 110.20	1250.70 ± 106.70	1233.05 ± 76.70	Pass
BS-3348, 3349	6/17/2005	Co-60	0.20 ± 0.04	0.22 ± 0.04	0.21 ± 0.03	Pass
BS-3348, 3349	6/17/2005	Cs-137	2.59 ± 0.10	2.51 ± 0.07	2.55 ± 0.06	Pass
BS-3348, 3349	6/17/2005	K-40	11.57 ± 0.81	11.82 ± 0.76	11.69 ± 0.56	Pass
DW-3486, 3487	6/28/2005	Gr. Beta	0.97 ± 0.54	1.67 ± 0.58	1.32 ± 0.40	Pass
SWT-3631, 3632	6/28/2005	Gr. Beta	2.12 ± 0.53	1.62 ± 0.56	1.87 ± 0.39	Pass
W-3507, 3508	6/29/2005	H-3	38717 ± 382	38017 ± 535	38367 ± 329	Pass
VE-3555, 3556	6/29/2005	Gr. Beta	7.53 ± 0.18	7.56 ± 0.18	7.55 ± 0.13	Pass
VE-3555, 3556	6/29/2005	K-40	5.70 ± 0.52	5.64 ± 0.53	5.67 ± 0.37	Pass
AP-3781, 3782	6/29/2005	Be-7	0.09 ± 0.02	0.08 ± 0.02	0.09 ± 0.01	Pass
LW-3610, 3611	6/30/2005	Gr. Beta	1.37 ± 0.35	1.40 ± 0.36	1.39 ± 0.25	Pass
SW-3760, 3761	6/30/2005	Gr. Beta	9.70 ± 1.63	9.77 ± 1.61	9.73 ± 1.15	Pass
E-3654, 3655	7/5/2005	Gr. Beta	1.76 ± 0.07	1.69 ± 0.07	1.72 ± 0.05	Pass
E-3654, 3655	7/5/2005	K-40	1.49 ± 0.25	1.05 ± 0.21	1.27 ± 0.16	Pass
MI-3676, 3677	7/5/2005	K-40	1383.90 ± 116.20	1428.20 ± 125.40	1406.05 ± 85.48	Pass
DW-3739, 3740	7/5/2005	I-131	1.93 ± 0.24	2.18 ± 0.23	2.05 ± 0.17	Pass
W-3808, 3809	7/6/2005	H-3	4189.61 ± 196.68	4438.33 ± 201.39	4313.97 ± 140.75	Pass
DW-3938, 3939	7/8/2005	I-131	1.11 ± 0.30	1.26 ± 0.31	1.18 ± 0.22	Pass
VE-3896, 3897	7/12/2005	K-40	3.44 ± 0.62	3.60 ± 0.36	3.52 ± 0.36	Pass
MI-3963, 3964	7/13/2005	K-40	1438.70 ± 102.80	1351.80 ± 100.80	1395.25 ± 71.99	Pass
DW-4068, 4069	7/15/2005	I-131	0.64 ± 0.27	0.91 ± 0.28	0.78 ± 0.20	Pass

TABLE A-5. In-House "Duplicate" Samples

Lab Code	Date	Analysis	Concentration (pCi/L) ^a			Acceptance
			First Result	Second Result	Averaged Result	
VE-4290, 4291	7/26/2005	Gr. Alpha	0.11 ± 0.04	0.05 ± 0.03	0.08 ± 0.03	Pass
VE-4290, 4291	7/26/2005	Gr. Beta	4.55 ± 0.13	4.69 ± 0.14	4.62 ± 0.09	Pass
SWU-4311, 4312	7/26/2005	Gr. Beta	2.62 ± 0.64	1.67 ± 0.37	2.15 ± 0.37	Pass
SWU-4311, 4312	7/26/2005	H-3	192.30 ± 92.90	304.60 ± 97.40	248.45 ± 67.30	Pass
G-4383, 4384	8/1/2005	Be-7	2.06 ± 0.49	1.76 ± 0.29	1.91 ± 0.28	Pass
G-4383, 4384	8/1/2005	Gr. Beta	8.76 ± 0.22	8.40 ± 0.20	8.58 ± 0.15	Pass
G-4383, 4384	8/1/2005	K-40	6.74 ± 0.64	6.88 ± 0.92	6.81 ± 0.56	Pass
MI-4425, 4426	8/1/2005	K-40	1358.10 ± 169.20	1267.90 ± 164.40	1313.00 ± 117.96	Pass
TD-4446, 4447	8/1/2005	H-3	563.00 ± 252.00	529.00 ± 251.00	546.00 ± 177.84	Pass
SL-4473, 4474	8/4/2005	Gr. Beta	5.44 ± 0.48	4.57 ± 0.42	5.00 ± 0.32	Pass
SL-4473, 4474	8/4/2005	K-40	2.91 ± 0.83	2.74 ± 0.54	2.82 ± 0.49	Pass
VE-4532, 4533	8/5/2005	Gr. Beta	31.20 ± 1.20	31.70 ± 1.20	31.45 ± 0.85	Pass
VE-4618, 4619	8/9/2005	Gr. Alpha	0.09 ± 0.05	0.09 ± 0.04	0.09 ± 0.03	Pass
VE-4618, 4619	8/9/2005	Gr. Beta	4.60 ± 0.13	4.54 ± 0.12	4.57 ± 0.09	Pass
VE-4618, 4619	8/9/2005	K-40	4.19 ± 0.46	4.34 ± 0.47	4.27 ± 0.33	Pass
F-4639, 4640	8/11/2005	Cs-137	0.05 ± 0.02	0.05 ± 0.02	0.05 ± 0.02	Pass
F-4639, 4640	8/11/2005	Gr. Beta	3.33 ± 0.11	3.37 ± 0.10	3.35 ± 0.07	Pass
F-4639, 4640	8/11/2005	K-40	2.62 ± 0.57	2.58 ± 0.59	2.60 ± 0.41	Pass
DW-4730, 4731	8/12/2005	I-131	0.82 ± 0.23	0.83 ± 0.25	0.83 ± 0.17	Pass
MI-4855, 4856	8/28/2005	K-40	1341.50 ± 107.70	1340.00 ± 114.70	1340.75 ± 78.67	Pass
MI-4855, 4856	8/28/2005	Sr-90	0.77 ± 0.37	0.87 ± 0.37	0.82 ± 0.26	Pass
MI-4945, 4946	8/31/2005	K-40	1388.90 ± 158.90	1307.50 ± 165.20	1348.20 ± 114.61	Pass
MI-4945, 4946	8/31/2005	Sr-90	0.67 ± 0.34	0.82 ± 0.36	0.75 ± 0.25	Pass
TD-4921, 4922	9/1/2005	H-3	5737.00 ± 266.00	5860.00 ± 269.00	5798.50 ± 189.15	Pass
VE-4900, 4901	9/2/2005	Gr. Beta	3.40 ± 0.06	3.51 ± 0.06	3.45 ± 0.04	Pass
VE-4900, 4901	9/2/2005	K-40	2.15 ± 0.27	2.27 ± 0.24	2.21 ± 0.18	Pass
DW-50769, 50770	9/2/2005	Gr. Alpha	6.17 ± 1.42	6.08 ± 1.46	6.13 ± 1.02	Pass
VE-4990, 4991	9/6/2005	K-40	18.81 ± 1.12	19.52 ± 0.86	19.17 ± 0.71	Pass
MI-5011, 5012	9/8/2005	K-40	1584.00 ± 194.00	1707.60 ± 173.00	1645.80 ± 129.97	Pass
VE-5119, 5120	9/12/2005	Gr. Alpha	0.10 ± 0.06	0.09 ± 0.05	0.10 ± 0.04	Pass
VE-5119, 5120	9/12/2005	Gr. Beta	6.05 ± 0.18	5.92 ± 0.17	5.98 ± 0.12	Pass
VE-5119, 5120	9/12/2005	K-40	4.61 ± 0.46	4.74 ± 0.69	4.68 ± 0.41	Pass
LW-5361, 5362	9/12/2005	Gr. Beta	1.09 ± 0.33	1.18 ± 0.34	1.13 ± 0.24	Pass
SW-5098, 5099	9/13/2005	I-131	0.44 ± 0.22	0.31 ± 0.20	0.38 ± 0.15	Pass
LW-5178, 5179	9/14/2005	Gr. Beta	2.92 ± 0.56	2.95 ± 0.59	2.93 ± 0.41	Pass
DW-5239, 5240	9/16/2005	I-131	0.45 ± 0.27	0.55 ± 0.29	0.50 ± 0.20	Pass
CF-5432, 5433	9/19/2005	Be-7	0.91 ± 0.40	0.64 ± 0.30	0.78 ± 0.25	Pass
CF-5432, 5433	9/19/2005	K-40	1.43 ± 0.34	1.38 ± 0.43	1.41 ± 0.27	Pass
MI-5292, 5293	9/21/2005	K-40	1228.80 ± 78.13	1297.00 ± 81.03	1262.90 ± 56.28	Pass
BS-5340, 5341	9/23/2005	Be-7	1286.10 ± 550.80	1222.90 ± 394.40	1254.50 ± 338.72	Pass
BS-5340, 5341	9/23/2005	Cs-137	726.97 ± 76.24	677.49 ± 70.03	702.23 ± 51.76	Pass

TABLE A-5. In-House "Duplicate" Samples

Lab Code	Date	Analysis	Concentration (pCi/L) ^a			Acceptance
			First Result	Second Result	Averaged Result	
BS-5340, 5341	9/23/2005	K-40	12404 ± 1154	13033 ± 983	12719 ± 758	Pass
DW-5382, 5383	9/23/2005	I-131	0.79 ± 0.31	0.53 ± 0.31	0.66 ± 0.22	Pass
MI-5405, 5406	9/27/2005	K-40	1324.80 ± 112.20	1366.80 ± 99.44	1345.80 ± 74.96	Pass
AP-5769, 5770	9/27/2005	Be-7	0.08 ± 0.01	0.09 ± 0.02	0.08 ± 0.01	Pass
AP-5983, 5984	9/27/2005	Be-7	0.08 ± 0.01	0.08 ± 0.01	0.08 ± 0.01	Pass
AP-5878, 5879	9/29/2005	Be-7	0.06 ± 0.01	0.07 ± 0.01	0.07 ± 0.01	Pass
G-5526, 5527	10/3/2005	Be-7	4.03 ± 0.62	4.07 ± 0.80	4.05 ± 0.51	Pass
G-5526, 5527	10/3/2005	Gr. Beta	8.10 ± 0.30	8.80 ± 0.40	8.41 ± 0.24	Pass
G-5526, 5527	10/3/2005	K-40	4.93 ± 0.67	6.00 ± 0.72	5.47 ± 0.49	Pass
VE-5721, 5722	10/10/2005	Gr. Alpha	0.07 ± 0.05	0.08 ± 0.06	0.08 ± 0.04	Pass
VE-5721, 5722	10/10/2005	Gr. Beta	5.09 ± 0.15	5.00 ± 0.16	5.05 ± 0.11	Pass
VE-5721, 5722	10/10/2005	K-40	4.27 ± 0.43	4.20 ± 0.34	4.23 ± 0.27	Pass
CF-5695, 5696	10/11/2005	Be-7	2.70 ± 0.37	2.80 ± 0.34	2.75 ± 0.25	Pass
CF-5695, 5696	10/11/2005	K-40	11.79 ± 0.86	13.11 ± 0.68	12.45 ± 0.55	Pass
LW-6129, 6130	10/11/2005	Gr. Beta	1.34 ± 0.25	1.85 ± 0.29	1.59 ± 0.19	Pass
LW-6129, 6130	10/11/2005	H-3	304.35 ± 95.31	369.23 ± 97.88	336.79 ± 68.31	Pass
DW-50844, 5	10/11/2005	Gr. Beta	5.30 ± 1.50	4.20 ± 1.40	4.75 ± 1.03	Pass
LW-5748, 5749 ^c	10/12/2005	Gr. Beta	1.09 ± 0.25	1.89 ± 0.28	1.49 ± 0.19	Fail
AP-6485, 6486	10/20/2005	Be-7	0.10 ± 0.03	0.09 ± 0.03	0.09 ± 0.02	Pass
SWU-6156, 6157	10/25/2005	Gr. Beta	4.69 ± 1.34	4.18 ± 1.34	4.44 ± 0.95	Pass
VE-6186, 6187	10/26/2005	K-40	2.90 ± 0.49	2.83 ± 0.51	2.87 ± 0.35	Pass
LW-6203, 6204	10/27/2005	Gr. Beta	2.92 ± 0.62	3.09 ± 0.66	3.01 ± 0.45	Pass
SO-6270, 6271	10/28/2005	Cs-137	0.33 ± 0.03	0.34 ± 0.04	0.33 ± 0.03	Pass
SO-6270, 6271	10/28/2005	Gr. Beta	26.85 ± 2.78	22.25 ± 2.41	24.55 ± 1.84	Pass
SO-6270, 6271	10/28/2005	K-40	13.67 ± 0.74	14.02 ± 0.76	13.85 ± 0.53	Pass
TD-6320, 6321	11/1/2005	H-3	444202 ± 1770	446633 ± 1775	445418 ± 1253	Pass
SO-6605, 6606	11/11/2005	Gr. Beta	18.22 ± 2.23	18.47 ± 2.22	18.35 ± 1.57	Pass
CF-6509, 6510	11/14/2005	K-40	0.85 ± 0.14	0.99 ± 0.22	0.92 ± 0.13	Pass
SW-6638, 6639	11/22/2005	I-131	0.95 ± 0.35	0.67 ± 0.31	0.81 ± 0.23	Pass
SO-6887, 6888	11/22/2005	Gr. Alpha	6.80 ± 2.92	10.27 ± 3.26	8.53 ± 2.19	Pass
SO-6887, 6888	11/22/2005	Gr. Beta	19.27 ± 2.16	18.43 ± 2.21	18.85 ± 1.54	Pass
SO-6887, 6888	11/22/2005	K-40	14.29 ± 1.11	13.78 ± 0.78	14.03 ± 0.68	Pass
SWT-6721, 6722	11/29/2005	Gr. Beta	0.98 ± 0.31	0.87 ± 0.31	0.93 ± 0.22	Pass
VE-6775, 6776	11/29/2005	Gr. Beta	12.75 ± 0.28	13.16 ± 0.21	12.96 ± 0.18	Pass
LW-6743, 6744	11/30/2005	Gr. Beta	3.19 ± 0.47	2.50 ± 0.44	2.85 ± 0.32	Pass
DW-51023, 4	12/2/2005	Gr. Alpha	0.55 ± 1.40	2.21 ± 1.31	1.38 ± 0.96	Pass
SWT-7282, 7283	12/27/2005	Gr. Beta	1.62 ± 0.37	1.85 ± 0.38	1.74 ± 0.27	Pass

Note: Duplicate analyses are performed on every twentieth sample received in-house. Results are not listed for those analyses with activities that measure below the LLD.

^a Results are reported in units of pCi/L, except for air filters (pCi/Filter), food products, vegetation, soil, sediment (pCi/g).

^b 600 minute count time or longer, resulting in lower error.

^c Recount of W-5748, 2.38 ± 0.85 pCi/L Averaged result; 2.14 ± 0.45 pCi/L

TABLE A-6. Department of Energy's Mixed Analyte Performance Evaluation Program (MAPEP)^a.

Lab Code ^c	Date	Analysis	Concentration ^b			Acceptance
			Laboratory result	Known Activity	Control Limits ^d	
STW-1045	01/01/05	Gr. Alpha	0.45 ± 0.10	0.53	0.00 - 1.05	Pass
STW-1045	01/01/05	Gr. Beta	1.90 ± 0.10	1.67	0.84 - 2.51	Pass
STW-1046	01/01/05	Am-241	1.62 ± 0.12	1.72	1.20 - 2.24	Pass
STW-1046	01/01/05	Co-57	239.40 ± 1.20	227.00	158.90 - 295.10	Pass
STW-1046	01/01/05	Co-60	248.70 ± 1.00	251.00	175.70 - 326.30	Pass
STW-1046	01/01/05	Cs-134	115.50 ± 1.80	127.00	88.90 - 165.10	Pass
STW-1046	01/01/05	Cs-137	328.50 ± 1.70	332.00	232.40 - 431.60	Pass
STW-1046	01/01/05	Fe-55	64.90 ± 7.00	75.90	53.13 - 98.67	Pass
STW-1046	01/01/05	H-3	304.00 ± 9.70	280.00	196.00 - 364.00	Pass
STW-1046	01/01/05	Mn-54	334.80 ± 1.90	331.00	231.70 - 430.30	Pass
STW-1046	01/01/05	Ni-63	7.10 ± 1.60	9.00	0.00 - 20.00	Pass
STW-1046	01/01/05	Pu-238	0.01 ± 0.02	0.02	0.00 - 1.00	Pass
STW-1046	01/01/05	Pu-239/40	2.50 ± 0.14	2.40	1.68 - 3.12	Pass
STW-1046	01/01/05	Sr-90	0.70 ± 0.80	0.00	0.00 - 5.00	Pass
STW-1046	01/01/05	Tc-99	43.20 ± 1.40	42.90	30.03 - 55.77	Pass
STW-1046	01/01/05	U-233/4	3.31 ± 0.20	3.24	2.27 - 4.21	Pass
STW-1046	01/01/05	U-238	3.38 ± 0.20	3.33	2.33 - 4.33	Pass
STW-1046	01/01/05	Zn-65	538.40 ± 3.80	496.00	347.20 - 644.80	Pass
STVE-1047	01/01/05	Co-57	10.60 ± 0.20	9.88	6.92 - 12.84	Pass
STVE-1047	01/01/05	Co-60	3.00 ± 0.20	3.15	2.21 - 4.10	Pass
STVE-1047	01/01/05	Cs-134	4.80 ± 0.40	5.00	3.50 - 6.50	Pass
STVE-1047	01/01/05	Cs-137	4.10 ± 0.30	4.11	2.88 - 5.34	Pass
STVE-1047	01/01/05	Mn-54	5.10 ± 0.30	5.18	3.63 - 6.73	Pass
STVE-1047	01/01/05	Zn-65	6.20 ± 0.50	6.29	4.40 - 8.18	Pass
STSO-1048	01/01/05	Am-241	96.60 ± 10.00	109.00	76.30 - 141.70	Pass
STSO-1048	01/01/05	Co-57	264.00 ± 2.00	242.00	169.40 - 314.60	Pass
STSO-1048	01/01/05	Co-60	226.50 ± 2.20	212.00	148.40 - 275.60	Pass
STSO-1048	01/01/05	Cs-134	760.60 ± 3.70	759.00	531.30 - 986.70	Pass
STSO-1048	01/01/05	Cs-137	336.20 ± 3.60	315.00	220.50 - 409.50	Pass
STSO-1048	01/01/05	K-40	663.70 ± 18.00	604.00	422.80 - 785.20	Pass
STSO-1048	01/01/05	Mn-54	541.30 ± 3.90	485.00	339.50 - 630.50	Pass
STSO-1048	01/01/05	Ni-63	924.30 ± 17.20	1220.00	854.00 - 1586.00	Pass
STSO-1048	01/01/05	Pu-238	0.60 ± 0.80	0.48	0.00 - 1.00	Pass
STSO-1048	01/01/05	Pu-239/40	78.00 ± 4.80	89.50	62.65 - 116.35	Pass
STSO-1048	01/01/05	Sr-90	514.60 ± 18.70	640.00	448.00 - 832.00	Pass
STSO-1048	01/01/05	U-233/4	47.90 ± 4.00	62.50	43.75 - 81.25	Pass
STSO-1048	01/01/05	U-238	226.30 ± 8.60	249.00	174.30 - 323.70	Pass
STSO-1048	01/01/05	Zn-65	851.30 ± 7.30	810.00	567.00 - 1053.00	Pass
STAP-1050	01/01/05	Gr. Alpha	0.11 ± 0.03	0.23	0.00 - 0.46	Pass
STAP-1050	01/01/05	Gr. Beta	0.38 ± 0.05	0.30	0.15 - 0.45	Pass

TABLE A-6. Department of Energy's Mixed Analyte Performance Evaluation Program (MAPEP)^a.

Lab Code ^c	Date	Analysis	Concentration ^b			Acceptance
			Laboratory result	Known Activity	Control Limits ^d	
STAP-1049	01/01/05	Am-241	0.10 ± 0.04	0.10	0.07 - 0.13	Pass
STAP-1049	01/01/05	Co-57	4.76 ± 0.64	4.92	3.44 - 6.40	Pass
STAP-1049	01/01/05	Co-60	2.84 ± 0.22	3.03	2.12 - 3.94	Pass
STAP-1049	01/01/05	Cs-134	3.54 ± 0.37	3.51	2.46 - 4.56	Pass
STAP-1049	01/01/05	Cs-137	2.20 ± 0.27	2.26	1.58 - 2.94	Pass
STAP-1049	01/01/05	Mn-54	3.15 ± 0.21	3.33	2.33 - 4.33	Pass
STAP-1049	01/01/05	Pu-238	0.16 ± 0.04	0.20	0.14 - 0.25	Pass
STAP-1049	01/01/05	Pu-239/40	0.17 ± 0.02	0.17	0.14 - 0.25	Pass
STAP-1049 ^e	01/01/05	Sr-90	2.24 ± 0.34	1.35	0.95 - 1.76	Fail
STAP-1049	01/01/05	U-233/4	0.34 ± 0.02	0.34	0.24 - 0.44	Pass
STAP-1049	01/01/05	U-238	0.35 ± 0.02	0.35	0.25 - 0.46	Pass
STAP-1049	01/01/05	Zn-65	3.12 ± 0.15	3.14	2.20 - 4.08	Pass
STW-1061	07/01/05	Am-241	2.21 ± 0.13	2.23	1.56 - 2.90	Pass
STW-1061	07/01/05	Co-57	293.20 ± 7.30	272.00	190.40 - 353.60	Pass
STW-1061	07/01/05	Co-60	275.70 ± 1.30	261.00	182.70 - 339.30	Pass
STW-1061	07/01/05	Cs-134	171.80 ± 4.00	167.00	116.90 - 217.10	Pass
STW-1061	07/01/05	Cs-137	342.10 ± 2.20	333.00	233.10 - 432.90	Pass
STW-1061	07/01/05	Fe-55	167.80 ± 9.30	196.00	137.20 - 254.80	Pass
STW-1061	07/01/05	H-3	514.20 ± 12.60	527.00	368.90 - 685.10	Pass
STW-1061	07/01/05	Mn-54	437.00 ± 2.50	418.00	292.60 - 543.40	Pass
STW-1061	07/01/05	Ni-63	105.10 ± 3.60	100.00	70.00 - 130.00	Pass
STW-1061	07/01/05	Pu-238	1.64 ± 0.12	1.91	1.34 - 2.48	Pass
STW-1061	07/01/05	Pu-239/40	2.32 ± 0.13	2.75	1.93 - 3.58	Pass
STW-1061	07/01/05	Sr-90	9.20 ± 1.30	8.98	6.29 - 11.67	Pass
STW-1061	07/01/05	Tc-99	72.30 ± 2.30	66.50	46.55 - 86.45	Pass
STW-1061	07/01/05	U-233/4	4.11 ± 0.18	4.10	2.87 - 5.33	Pass
STW-1061	07/01/05	U-238	4.14 ± 0.18	4.26	2.98 - 5.54	Pass
STW-1061	07/01/05	Zn-65	364.60 ± 4.90	330.00	231.00 - 429.00	Pass
STW-1062	07/01/05	Gr. Alpha	0.57 ± 0.05	0.79	0.21 - 1.38	Pass
STW-1062	07/01/05	Gr. Beta	1.36 ± 0.05	1.35	0.85 - 1.92	Pass
STSO-1063 ¹	07/01/05	Am-241	48.40 ± 3.90	81.10	56.77 - 105.43	Fail
STSO-1063	07/01/05	Co-57	608.30 ± 2.80	524.00	366.80 - 681.20	Pass
STSO-1063	07/01/05	Co-60	322.70 ± 2.40	287.00	200.90 - 373.10	Pass
STSO-1063	07/01/05	Cs-134	632.10 ± 5.20	568.00	397.60 - 738.40	Pass
STSO-1063	07/01/05	Cs-137	512.40 ± 4.20	439.00	307.30 - 570.70	Pass
STSO-1063	07/01/05	K-40	720.50 ± 19.00	604.00	422.80 - 785.20	Pass
STSO-1063	07/01/05	Mn-54	516.80 ± 5.10	439.00	307.30 - 570.70	Pass
STSO-1063	07/01/05	Ni-63	366.50 ± 13.30	445.00	311.50 - 578.50	Pass
STSO-1063	07/01/05	Pu-238	68.80 ± 15.00	60.80	42.56 - 79.04	Pass
STSO-1063	07/01/05	Pu-239/40	0.00 ± 0.00	0.00	0.00 - 0.00	Pass
STSO-1063	07/01/05	Sr-90	602.90 ± 17.20	757.00	529.90 - 984.10	Pass
STSO-1063	07/01/05	U-233/4	61.50 ± 1.00	52.50	36.75 - 68.25	Pass
STSO-1063	07/01/05	U-238	164.50 ± 16.70	168.00	117.60 - 218.40	Pass
STSO-1063	07/01/05	Zn-65	874.70 ± 8.40	823.00	576.10 - 1070.00	Pass

TABLE A-6. Department of Energy's Mixed Analyte Performance Evaluation Program (MAPEP)^a.

Lab Code ^c	Date	Analysis	Concentration ^b		Control Limits ^d	Acceptance
			Laboratory result	Known Activity		
STVE-1064	07/01/05	Am-241	0.18 ± 0.03	0.23	0.16 - 0.30	Pass
STVE-1064	07/01/05	Co-57	15.90 ± 0.20	13.30	9.31 - 17.29	Pass
STVE-1064	07/01/05	Co-60	4.80 ± 0.10	4.43	3.10 - 5.76	Pass
STVE-1064	07/01/05	Cs-134	4.60 ± 0.20	4.09	2.86 - 5.32	Pass
STVE-1064	07/01/05	Cs-137	5.90 ± 0.30	5.43	3.80 - 7.06	Pass
STVE-1064	07/01/05	Mn-54	7.20 ± 0.20	6.57	4.60 - 8.54	Pass
STVE-1064	07/01/05	Pu-238	0.04 ± 0.02	0.00	0.00 - 1.00	Pass
STVE-1064	07/01/05	Pu-239/40	0.13 ± 0.02	0.16	0.11 - 0.21	Pass
STVE-1064	07/01/05	Sr-90	2.80 ± 0.30	2.42	1.69 - 3.15	Pass
STVE-1064	07/01/05	U-233/4	0.28 ± 0.03	0.33	0.23 - 0.43	Pass
STVE-1064	07/01/05	U-238	0.33 ± 0.04	0.35	0.24 - 0.45	Pass
STVE-1064	07/01/05	Zn-65	11.00 ± 0.50	10.20	7.14 - 13.26	Pass
STAP-1065	07/01/05	Gr. Alpha	0.30 ± 0.04	0.48	0.00 - 0.80	Pass
STAP-1065	07/01/05	Gr. Beta	0.97 ± 0.06	0.83	0.55 - 1.22	Pass
STAP-1066	07/01/05	Am-241	0.14 ± 0.03	0.16	0.11 - 0.21	Pass
STAP-1066	07/01/05	Co-57	5.81 ± 0.17	6.20	4.34 - 8.06	Pass
STAP-1066	07/01/05	Co-60	2.79 ± 0.14	2.85	2.00 - 3.71	Pass
STAP-1066	07/01/05	Cs-134	3.67 ± 0.12	3.85	2.70 - 5.01	Pass
STAP-1066	07/01/05	Cs-137	2.93 ± 0.23	3.23	2.26 - 4.20	Pass
STAP-1066	07/01/05	Mn-54	4.11 ± 0.26	4.37	3.06 - 5.68	Pass
STAP-1066	07/01/05	Pu-238	0.11 ± 0.02	0.10	0.07 - 0.13	Pass
STAP-1066	07/01/05	Pu-239/40	0.10 ± 0.01	0.09	0.06 - 0.12	Pass
STAP-1066	07/01/05	Sr-90	2.25 ± 0.29	2.25	1.58 - 2.93	Pass
STAP-1066	07/01/05	U-233/4	0.28 ± 0.02	0.27	0.19 - 0.35	Pass
STAP-1066	07/01/05	U-238	0.28 ± 0.02	0.28	0.20 - 0.37	Pass
STAP-1066	07/01/05	Zn-65	4.11 ± 0.26	4.33	3.06 - 5.68	Pass

^a Results obtained by Environmental, Inc., Midwest Laboratory as a participant in the Department of Energy's Mixed Analyte Performance Evaluation Program, Idaho Operations office, Idaho Falls, Idaho

^b Results are reported in units of Bq/kg (soil), Bq/L (water) or Bq/total sample (filters, vegetation) as requested by the Department of Energy.

^c Laboratory codes as follows: STW (water), STAP (air filter), STSO (soil), STVE (vegetation).

^d MAPEP results are presented as the known values and expected laboratory precision (1 sigma, 1 determination) and control limits as defined by the MAPEP.

^e The strontium carbonate precipitates were redissolved and processed. The average of the three analyses was 1.34 pCi/L although the recovery was only 30%. The result of a new analysis was 1.56 pCi/L.

^f Incorrect sample weight used in calculation. Result of recalculation: 97.0 ± 7.8 Bq/kg.

ATTACHMENT F

DATA GRAPHS

3 Pages Follow

Palisades Air Particulate
Gross Beta
Pre-Operational vs. Operational

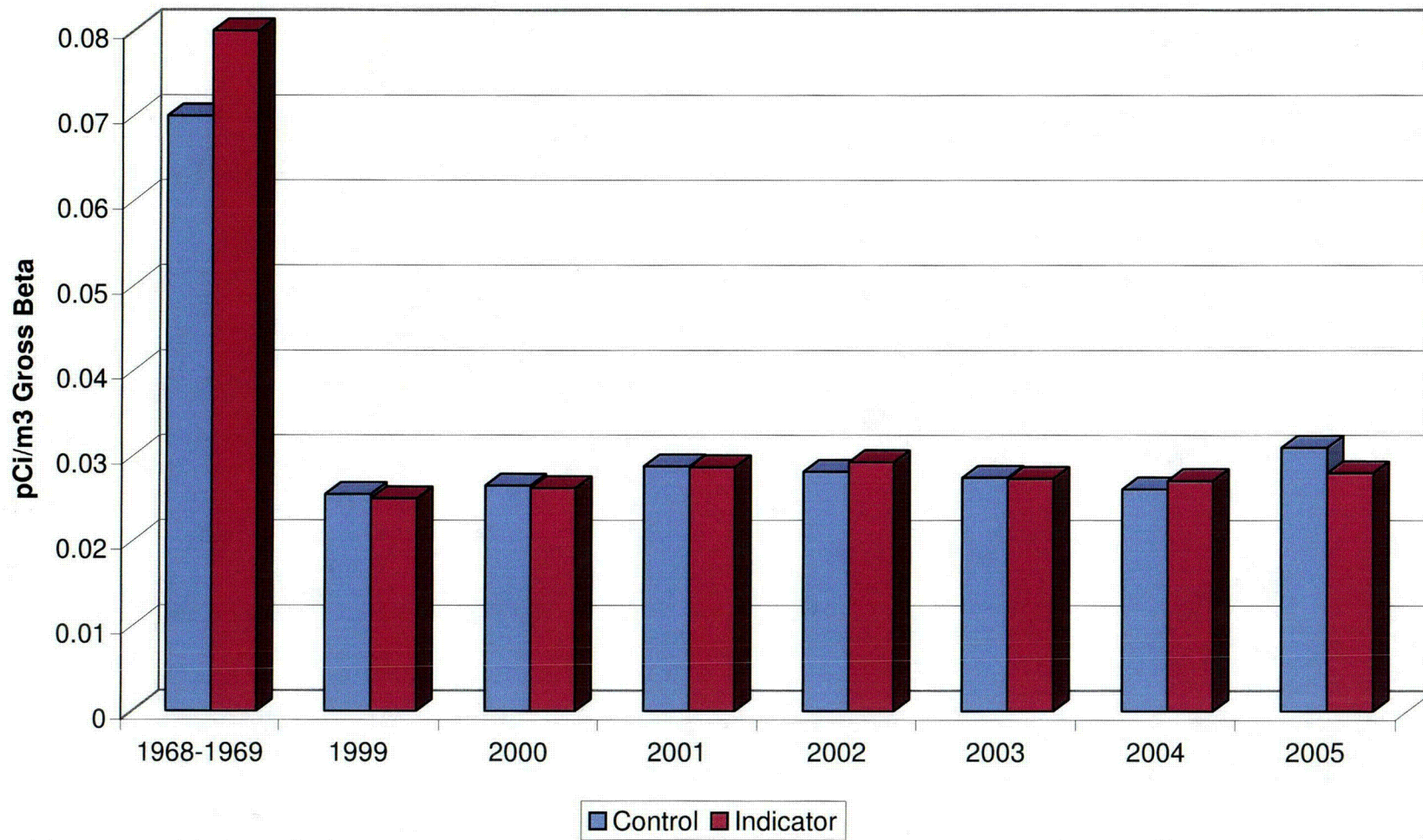

COI

Lake Water Gross Beta
2000 to 2005

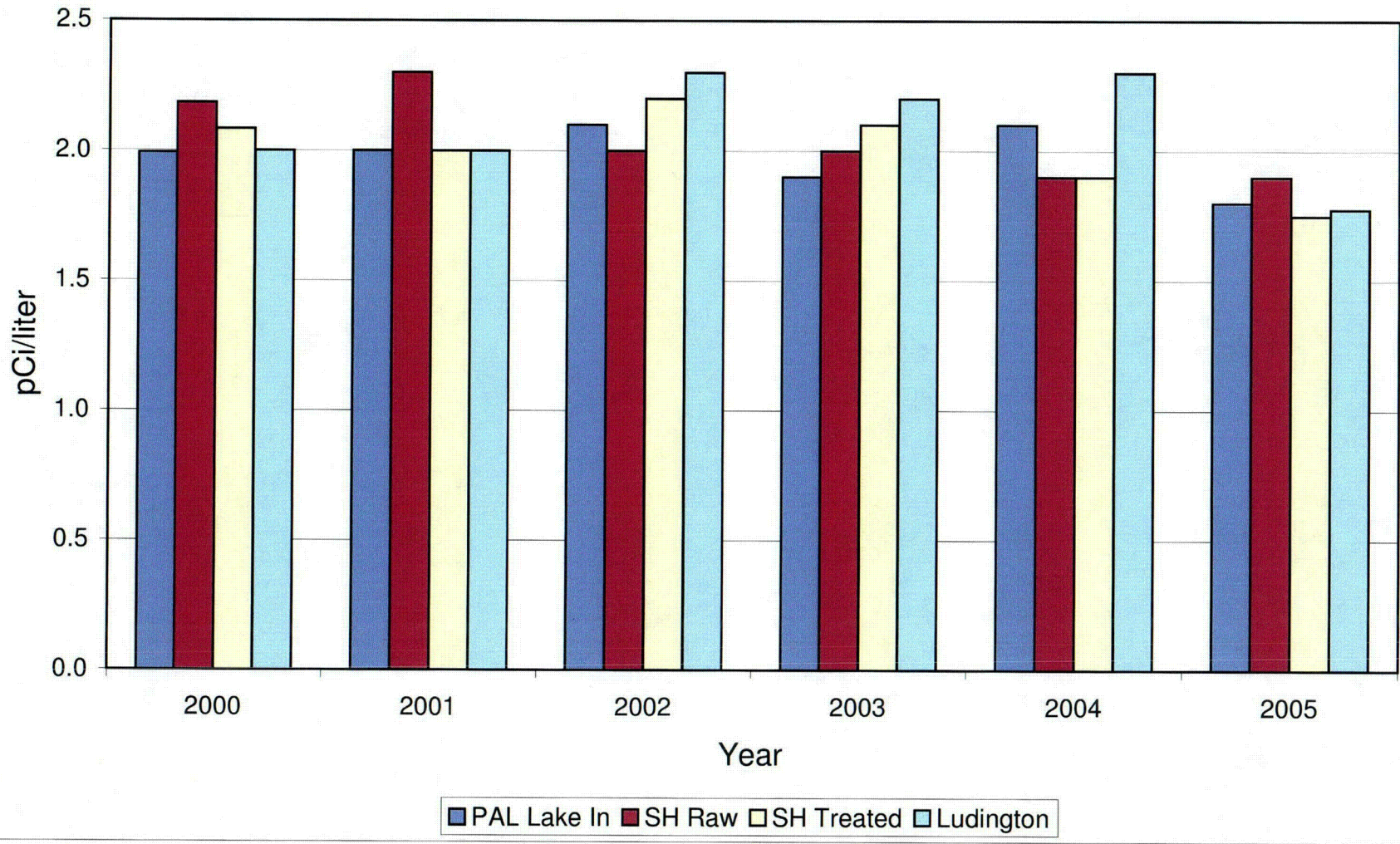

CO2

Palisades Monthly Thermoluminescent Dosimeters
Pre-Operational vs. Operational

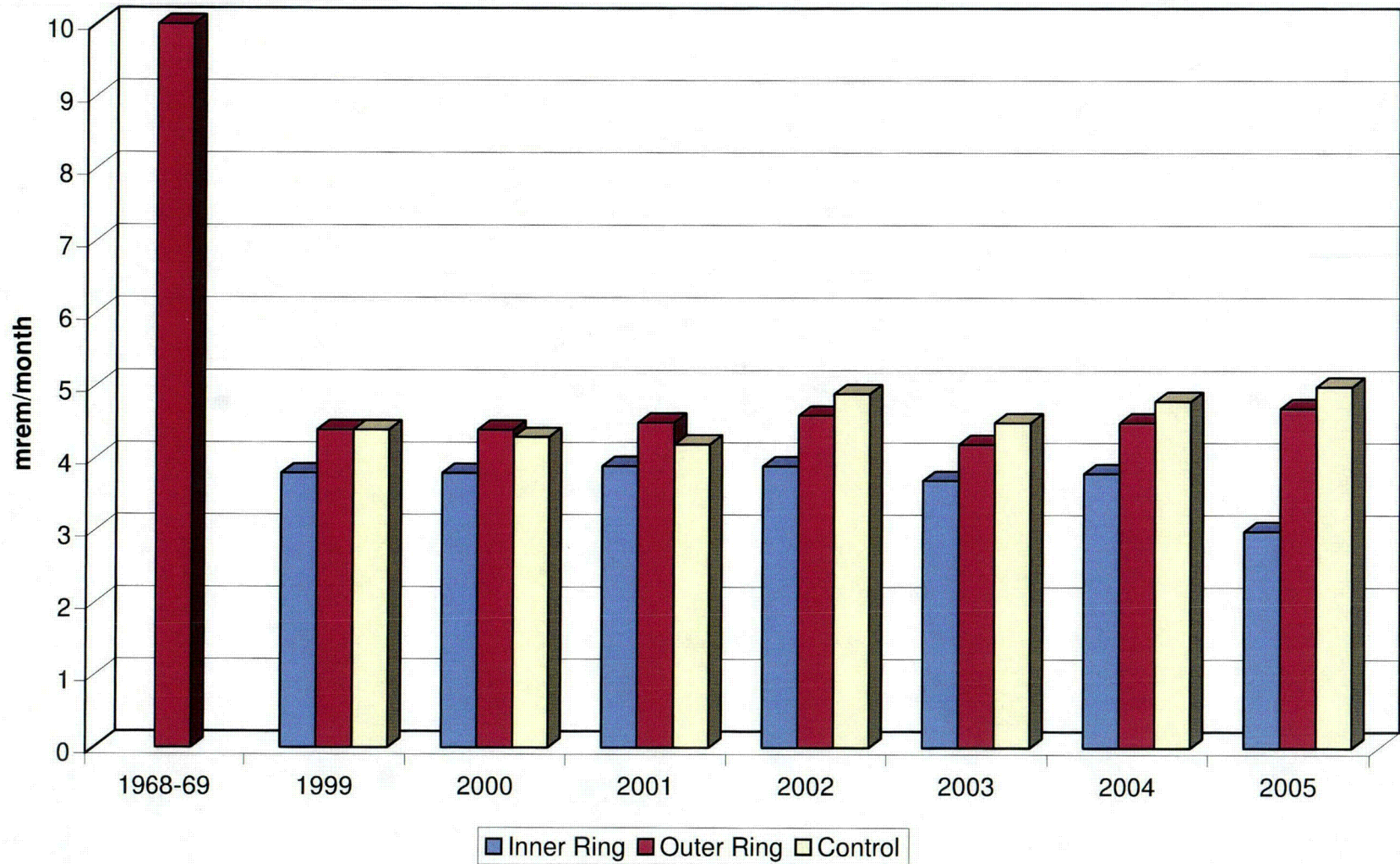

C03