

Mr. Dwight Shelor, Director
 Program Management and Administration
 Office of Civilian Radioactive Waste Management
 U.S. Department of Energy
 1000 Independence Avenue, SW
 Washington, DC 20585

March 7, 2000

Subject: MINUTES OF THE DECEMBER 16, 1999, MANAGEMENT MEETING

Dear Mr. Shelor:

Enclosed are the minutes of the December 16, 1999, Management Meeting between the U.S. Department of Energy (DOE) and the U.S. Nuclear Regulatory Commission (NRC) concerning discussion of items of mutual interest of DOE's site characterization programs at Yucca Mountain, Nevada. The meeting minutes consist of the meeting summary highlights, the attendance list, agenda and the presentation material noted as enclosures 1A, 1, 2, and 3, respectively. This meeting included participation by video conference by Las Vegas and San Antonio. Organizations other than DOE and NRC that were represented at the meeting were the Center for Nuclear Waste Regulatory Analyses; DOE's Management and Operating Contractor; the State of Nevada's Nuclear Waste Project Office; Clark and Nye Counties, Nevada; Nevada Legislature, Nuclear Energy Institute, representatives from Electric utilities and the U.S. Geological Survey.

The meeting resulted in a good exchange of information and views between DOE and NRC. No response to this letter is required. If you have any questions regarding the enclosed meeting minutes, please contact Manny Comar at (301) 415-6074.

Sincerely,

[Original signed by:]

C. William Reamer, Chief
 High-Level Waste and Performance
 Assessment Branch
 Division of Waste Management
 Office of Nuclear Material Safety
 and Safeguards

Enclosures: As stated
 cc: See attached list

FILE CENTER EMP

DISTRIBUTION: FILE CENTER NMSS r/f PAHL r/f DWM r/f ACNW
 On-Site Reps SWastler LCampbell SBahadur DBrooks JBradbury
 PJustus JTrapp T McCartin N Coleman B Leslie TAhn

WH-11

DOCUMENT NAME: S:\DWM\HLWB\MMC1\coverletter.wpd

OFC	HLWB*		HLWB*		HLWB*		
NAME	MComar: vm		NKStablein		CWReamer		
DATE	03/16/00		03/17/00		03/17/00		

06-48

DF03

OFFICIAL RECORD COPY

ACNW: YES NO Delete file after distribution: YES NO

1) This document should/should not be made available to the PUBLIC ve 3/6
 (Initials) (Date)

2) This document is/is not related to the HLW program. It is related to HLW, it should/should not be placed in the LSS.
 ACNW: YES NO Delete file after distribution: Yes No

DOE also discussed the qualification of data and prioritization of this work. DOE clarified that all data, including Nye County data, that will be relied upon during licensing will be qualified under the data qualification process. Although the NRC prefers that all data be qualified at the time the SRCR is issued, DOE indicated that its approach would result in qualification of the data most significant to performance.

NRC will provide DOE with a realistic assessment of their timeline for preparing sufficiency comments, as required by the Nuclear Waste Policy Act. NRC staff feels that the sufficiency comments must be based on the most current data as contained in Process Model Reports (PMRs) or other program documents. NRC staff expressed concern about their ability to meet the legislative mandate for comments on the sufficiency of DOE's program due to release dates of revision 1 of the PMRs.

Closing Remarks: The NRC requested closing remarks from the Affected Units of Government; there were none. Due to technical difficulties with the video conferencing facilities, NRC offered an additional meeting to go over topics discussed for those attending the meeting in Las Vegas, Nevada, who were unable to participate.

The NRC stated that they would continue to monitor program activities to ensure quality initiatives are met. Both DOE and the NRC reiterated their commitment to quality. No regulatory decisions were requested or made during the meeting.

Action Items:

1. DOE will include disruptive events in Revision 4 to the Repository Safety Strategy.
2. DOE will provide monthly updates of quality performance indicators to NRC's On-site Representative, for such items as the backlog of deficiencies, self-assessments, and the quality of technical documents.
3. DOE will provide an evaluation of the status of data qualification at the time the SRCR is issued, including a discussion of the impacts of using non-qualified data.
4. DOE will provide additional information pertaining to the methodology used in determining the extent to which QL-2 (low risk) data is reviewed during the data reverification effort. The NRC staff will follow up on this item.
5. NRC will provide DOE with a realistic timeline for preparing its sufficiency comments.

Manny M. Comar
Division of Waste Management
Office of Nuclear Material
Safety and Safeguards
U. S. Nuclear Regulatory Commission

Alan B. Brownstein, Director
Regulatory Coordination Division
Office of Civilian Radioactive
Waste Management
U. S. Department of Energy

DOE/NRC MANAGEMENT MEETING
 Rockville, MD
 Dec. 16, 1999
 List of Attendees

NAME	PHONE #	ORGANIZATION
Manny Comar	301-415-6074	NRC
April Gil	702-294-5578	DOE/YMP/OLRC
Mike Tuckaan	704-382-2200	Duke Energy
Louis Long	201-992-4560	Southern Nuclear
Adam Levin	630-663-7406	Commonwealth Edison
Stephen H. Hanauer	202-586-3547	DOE
Tamara Bloomer	301-415-6626	NRC
Ronald J. Stevens	702-295-6273	M&O Yucca Mountain
Marvin Fertel	202-739-8082	NEI
Douglas Rotinski	202-371-5820	Winston & Strawn
Robert Murray	702-794-5566	MTS/BAH
Amy Shollenberger	202-454-5118	Public Citizen Critical Mass Energy Proj.
Charles F. Metzger	202-626-1054	OCRWM/MTS
Suzanne Mellington	702-794-1454	DOE/YMP/OPE
Carol Hanlon	702-794-1324	DOE/YMP/OLRC
Bob Gamble	702-794-1440	MTS/BAH
K. Michael Cline	702-794-5481	MTS/BAH
Tim Sweeney	202-479-2107	SAIC/M&O
Terry Dunn	202-586-0764	MD-3 /SAIC
Robert Latta	301-415-7284	NRC
David Brooks	301-415-7284	NRC/DWM
King Stablein	301-415-7445	NRC/DWM/HLWB
Philip Justus	301-415-6745	NRC/DWM/ALWB

NAME	PHONE #	ORGANIZATION
Steven Brocoum	702-794-1359	YMP/OLRC
Donald G. Horton	702-794-1301	YMP/PMD
Daniel R. Wilkins	702-295-5143	M&O
Jack Bailey	702-295-4251	M&O
Bob Clark	702-794-5583	DOE
R.E. Spence	702-794-1455	DOE/OPE
George E Dials	702-295-2936	TRW/M&O
Robert L Howard	702-295-3097	TRW/M&O
John Greeves	301-415-7437	NRC
Bill Reamer	301-415-6537	NRC
Christopher Kouts	202-586-1253	DOE
Larry L. Campbell	301-415-5000	NRC
Mal Murphy	360-943-5610	Nye County
Jean Younker	702-295-5497	M&O
Bill Belke	702-794-5047	NRC
Dennis R. Williams	702-794-5526	DOE/YM/OL&RC
Mike Lugo	702-295-4761	M&O/R&L
Don Watkins	202-295-5093	M&O/R&L
Homi Minwalla	702-295-4995	M&O/RSO/SSO
Don Beckman	702-295-4392	M&O/R&L
Dennis Richardson	702-295-4392	M&O/R&L
Bob Price	702-642-5669	Nevada Legislature
Jill M. Schrecongost	702-794-5436	DOE/YMSCO/OIM
Ralph Rogers	702-794-1415	MTS/BAH
Robert Hasson	702-794-5023	OQA/QATSS
Robert Craig	702-295-5456	USGS

NAME	PHONE #	ORGANIZATION
Eve Swenning	702-295-1631	OQA/OHSS
Evon Tiesenhausen	702-455-5184	C County
R. Bradbury	702-794-5424	M&S
Robert Wemheuer	702-295-3966	M&O INEPO
Harry Mortenson	702-362-3366	State of NV Assembly
Bill Glasser	702-794-5014	QATSS/MACTEC
Chad Glenn	702-794-5046	NRC
Frank Kratzinger	702-794-5057	MTS
Hank Greene	702-295-2459	OQA/QAESS
Ram B. Murthy	702-794-5549	DOE/OPT
Tim Gunter	702-794-1343	DOE/YMSCO
Kayce Prince	702-295-5314	M&O/ SAIC
Rod McCullam	202-739-8082	NEI
Bruce Mabrito	210-522-5149	CNWRA
Pat Mackin	210-522-5054	CNWRA
W. Patrick	210-522-5158	CNWRA
Budhi Sagar	210-522-5252	CNWRA
Amitara Ghosh	210-522-3314	CNWRA
Tom Trbovich	210-522-3145	CNWRA
John Gervers	505-466-2662	Latir Energy Consultants

NRC/DOE MANAGEMENT/QUALITY ASSURANCE MEETING
 NRC Headquarters, Rockville, MD
Hillshire Blue Room, Las Vegas, Nevada; DOE Headquarters, Room 7F091
 CNWRA, San Antonio, Texas
 December 16, 1999, 12:00 noon to 5:00 p.m. (EST)

12:00 noon	INTRODUCTIONS Bill Kane Ivan Itkin NRC Program Status <ul style="list-style-type: none"> • Yucca Mountain Review Plan • Status of Part 63 • Streamlining • TSARs for Centralized Interim Storage Facility and Dry Transfer Storage Facility 	All NRC DOE John Greeves, NRC Bill Brach, NRC
12:30 p.m.	DOE Program Status <ul style="list-style-type: none"> • Yucca Mountain Design Evolution • FY00 Budget Work Scope • Legislation 	Lake Barrett, DOE
12:50 p.m.	M&O Program Status	George Dials, M&O
1:10 p.m.	Yucca Mountain Project Status <ul style="list-style-type: none"> • Nevada Water Permits • Status of 10 CFR 963 • Status of SR/LA Integrated Schedule and PMR/AMR Development • Quality Program - Prioritization • Introduction to Repository Safety Strategy • Process Model Report Progress Overview 	Scott Wade, DOE Christopher Kouts, DOE Steve Brocoum, DOE
1:50 p.m.	<ul style="list-style-type: none"> • Repository Safety Strategy 	Dick Spence, DOE Jack Bailey, M&O
2:20 p.m.	Break	All
2:35 p.m.	<ul style="list-style-type: none"> • Prioritization Process for Qualification of Inputs (Data, Software/Codes, and Models) used for Site Recommendation/Disposition of Unqualified Inputs • Status of Data, Model, and Code Qualification/ Validation and Control Plan • Process Model Report Quality Goals 	Rob Howard, M&O
3:35 p.m.	<ul style="list-style-type: none"> • Deficiency Closure Status 	Dick Spence, DOE
3:50 p.m.	<ul style="list-style-type: none"> • Status of PVAR Implementation • Timeliness of Corrective Actions • Performance Monitoring/Metrics • Scientific Notebooks • Status of Corrective Actions (CARs 98-002, 98-005, 98-006, 98-010, and 99-001) 	Dan Wilkins, M&O

4:20 p.m.	Office of Quality Assurance (OQA) <ul style="list-style-type: none">• Results of Process Model Report Audits• New Supplier Issues	Bob Clark, DOE
4:35 p.m.	Yucca Mountain Project Path Forward	Russ Dyer, DOE
4:50 p.m.	Closing Remarks	NRC, DOE
5:00 p.m.	Adjourn	All

DRY TRANSFER SYSTEM (DTS) AND CENTRALIZED INTERIM STORAGE FACILITY (CISF) NRC MILESTONES

DTS

DTS Topical Safety Analysis Report submitted to NRC	September 1996
NRC issues Request for Additional Information (RAI) No. 1	July 1998
DOE responds to RAI No. 1	January 1999
NRC issues RAI No. 2	June 1999
DOE responds to RAI No. 2	September 1999
CNWRA final input to SER	February 2000
NRC issues final SER	March 2000

CISF

DOE submits CISF Topical Safety Analysis Report (TSAR)	May 1997
NRC issues RAI	March 1998
DOE submits RAI response	June 1998
DOE submits Revision 1 of TSAR and revised RAI responses	September 1998
CNWRA submits final Assessment Report (AR) to NRC	April 2000
NRC issues final AR	June 2000

YUCCA MOUNTAIN PROJECT

M&O Program Status

Presented to:
NRC/DOE Management/Quality Assurance Meeting

Presented by:
George Dials
President and General Manager
CRWMS M&O

December 16, 1999

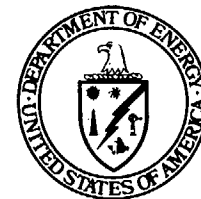

U.S. Department of Energy
Office of Civilian Radioactive
Waste Management

M&O Program Status

- Quality Assurance: Experience and Commitment
- Sensitivity to Licensing Needs/Requirements
- Organization and Process Improvements
- Preview of Status and Progress

YUCCA MOUNTAIN PROJECT



Yucca Mountain Project Status

- Nevada Water permits

Presented to:
NRC/DOE Management/Quality Assurance Meeting

Presented by:
Scott Wade
Environmental Safety & Health Team Lead
Yucca Mountain Site Characterization Office

December 16, 1999



U.S. Department of Energy
Office of Civilian Radioactive
Waste Management

YMP Water Appropriation Request

- DOE has requested 430 acre-feet water per year to meet its NWPA responsibilities
- Existing permits were for site characterization only and will expire in 2002
- Water will be used for all program phases (performance confirmation, repository phases, reclamation, etc.)
- Permit applications were filed in July 1997

Status of Application

- Four protests have been filed:
 - Nevada Nuclear Waste Projects Office
 - Citizens Alert
 - Michael Delee - Amargosa Valley resident
 - Ralph McCracken - Amargosa Valley resident
- National Park Service did not protest
- State Engineer held a 5-day administrative public hearing (November 8, 9, 10, 15, and 16, 1999)

Status of Application

(Continued)

- State Engineer decision-making criteria:
 - Is there unappropriated water at the source?
 - Does the water right conflict with existing rights?
 - Is granting the permit detrimental to the public interest? (in relation to Nevada water law)
- State Engineer decision expected early 2000

YUCCA MOUNTAIN PROJECT

Yucca Mountain Project Status

- Status of 10 CFR 963 (Proposed *Yucca Mountain Site Suitability Guidelines*)

Presented to:

NRC/DOE Management/Quality Assurance Meeting

Presented by:

Christopher Kouts

Office of Civilian Radioactive Waste Management

December 16, 1999

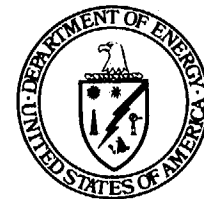

U.S. Department of Energy
Office of Civilian Radioactive
Waste Management

Status of 10 CFR 963, Proposed *Yucca Mountain Site Suitability Guidelines*

- DOE issued a revised proposal to amend the guidelines for evaluating the suitability of Yucca Mountain, which was published for public comment on 11/30/99
- Revised proposal presents the criteria and methodologies for assessing the performance of a potential Yucca Mountain repository in meeting preclosure and postclosure applicable radiation protection standards

Status of 10 CFR 963, Proposed *Yucca Mountain Site Suitability Guidelines*

(Continued)

- DOE proposed preclosure approach
 - Generally consistent with NRC's proposed 10 CFR 63
- DOE proposed postclosure approach
 - Based on the use of total system performance assessment
 - Generally consistent with:
 - Regulatory structure in EPA's proposed 40 CFR 197
 - NRC's proposed 10 CFR 63
 - Findings of the 1995 NAS Report - Technical Bases for Yucca Mountain Standards

Status of 10 CFR 963, Proposed *Yucca Mountain Site Suitability Guidelines*

(Continued)

- Under the proposal, DOE may determine that the site is suitable if the required evaluations show that the potential repository is likely to meet applicable radiation protection standards for the preclosure and postclosure periods

Status of 10 CFR 963, Proposed *Yucca Mountain Site Suitability Guidelines*

(Continued)

- A positive suitability determination will be one basis for a decision by the Secretary of Energy whether to formally recommend the site to the President for development
 - The Secretary must consider other information for a Site Recommendation, as required by the NWPA

Status of 10 CFR 963, Proposed *Yucca Mountain Site Suitability Guidelines*

(Continued)

- Public comment period on proposed rule ends on February 14, 2000
- Two public hearings will be held
 - Pahrump, NV (January 18, 2000)
 - Las Vegas, NV (January 19, 2000)

Status of 10 CFR 963, Proposed *Yucca Mountain Site Suitability Guidelines*

(Continued)

- DOE will also...
 - Consult with the Council on Environmental Quality, the EPA, the U.S. Geological Survey, and the State of Nevada during the public comment period
 - Seek NRC concurrence prior to issuing the final guidelines

YUCCA MOUNTAIN PROJECT



Yucca Mountain Project Status

- DOE's Plans and Progress Toward Site Recommendation

Presented to:

NRC/DOE Management/Quality Assurance Meeting

Presented by:

Stephan Brocoum, Assistant Manager
Office of Licensing and Regulatory Compliance
Yucca Mountain Site Characterization Project

December 16, 1999



U.S. Department of Energy
Office of Civilian Radioactive
Waste Management

Topics for Discussion

- Status of the site recommendation (SR) - license application (LA) multi-year plan
- DOE-NRC interactions on key technical documents for SR
- Quality program initiatives
- Repository Safety Strategy

Status of SR-LA Multi-Year Plan

- The multi-year plan for FY 00-03 is baselined and being implemented
- The plan is based on four product development areas
 - Final Environmental Impact Statement (FEIS)
 - Site Recommendation (SR)
 - License Application (LA)
 - Monitored Geologic Repository (covers work related to post-LA activities and products)

Status of SR-LA Multi-Year Plan

(Continued)

- Focus for FY 00
 - Resolve QA deficiencies and enhance quality
 - Complete the FEIS for issuance in 11/00
 - Complete testing and documentation to support the Site Recommendation Consideration Report (SRCR)
 - Interact with the NRC and NWTRB on the technical basis documentation for the SRCR
 - Prepare the SRCR for issuance in 11/00
 - Interact with NRC on its Yucca Mountain LA review plan and Issue Resolution Status Reports, and on DOE's Technical Guidance Document (TGD) for LA preparation

Site Recommendation Structure

AMR	Analysis/Model Report
DEIS	Draft Environmental Impact Statement
EIS	Environmental Impact Statement
FEIS	Final Environmental Impact Statement
IRSR	Issue Resolution Status Report
NRC	Nuclear Regulatory Commission
PMR	Process Model Report
SDD	System Description Document
SR	Site Recommendation
TSLCC	Total System Life Cycle Cost
TSPA	Total System Performance Assessment

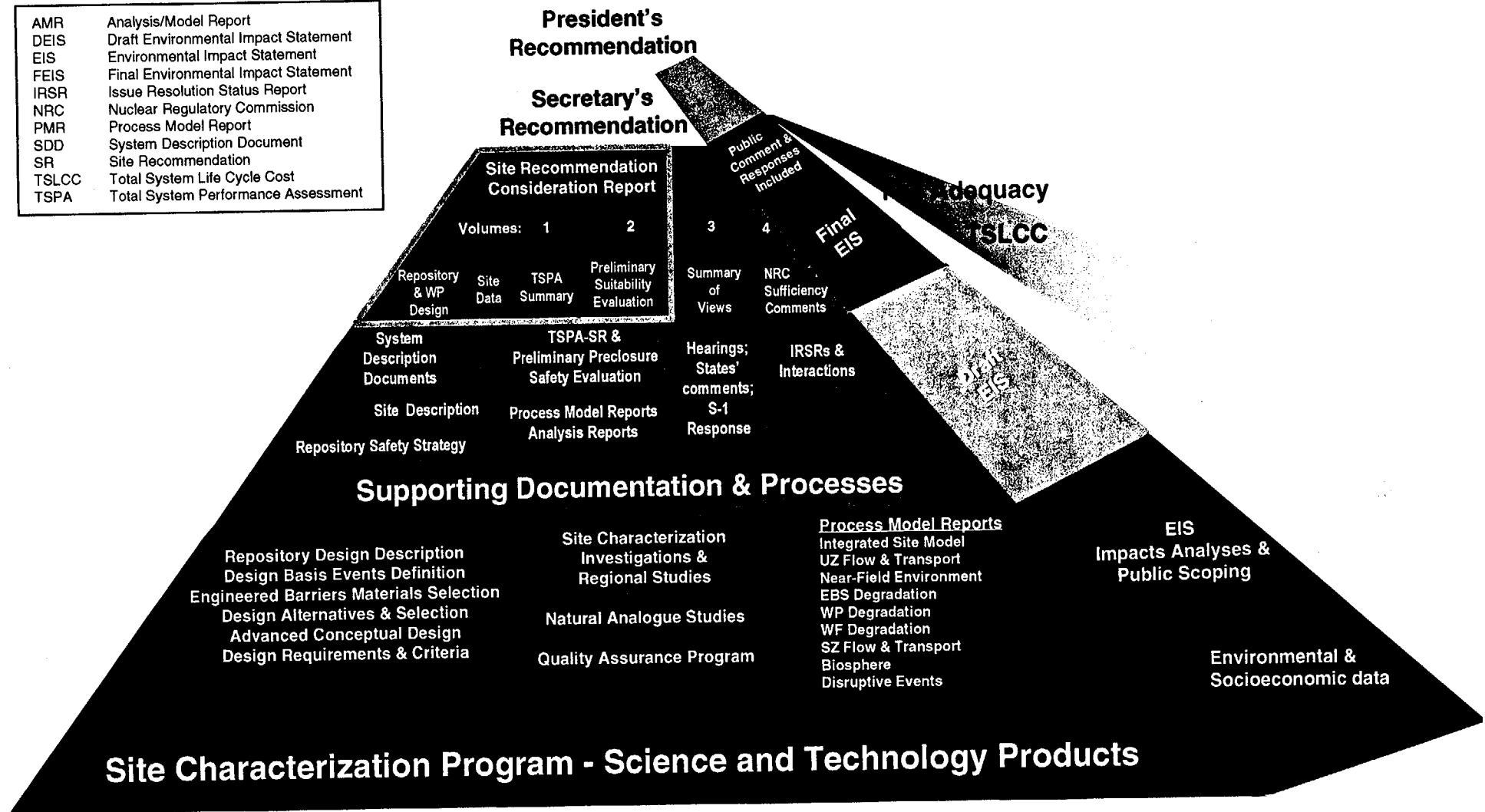

Linkage of Major TSPA Products for SR and LA

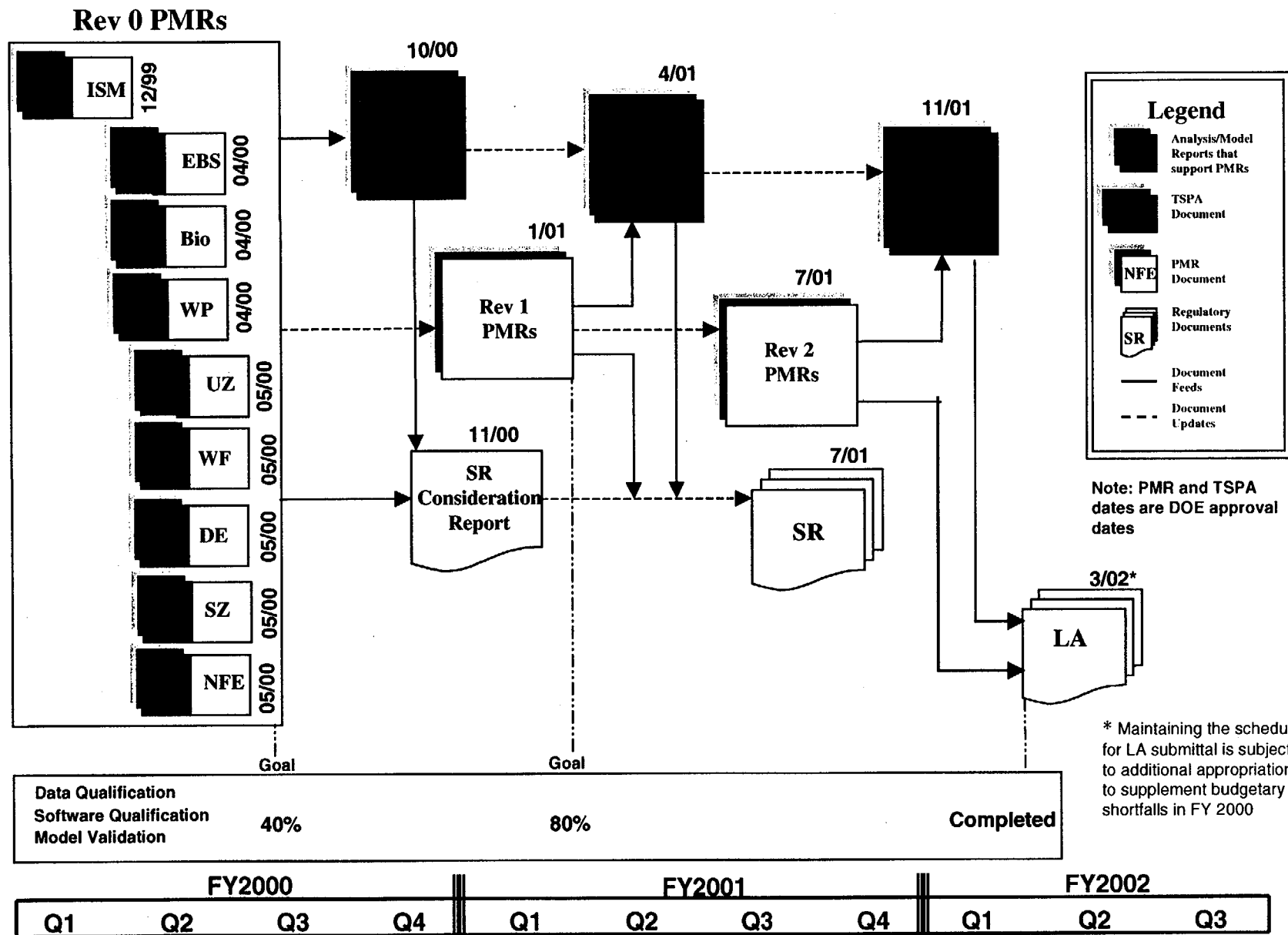

NRC Sufficiency Comments Needed for SR

- The NWPA requires that the Secretary include as part of the comprehensive statement of the basis for a site recommendation
 - “preliminary comments of the Commission concerning the extent to which the at-depth site characterization analysis and the waste form proposal for such site seem to be sufficient for inclusion in any [license] application to be submitted by the Secretary”
- DOE is seeking ways to provide NRC with the information needed to support development of these comments

DOE-NRC Interactions on Key Technical Documents for SR

- DOE proposes to provide NRC with key technical documents for the SRCR as they are completed
 - Letter, S. Brocoum to J. Greeves, 11/24/99
 - Modeled after process employed to support NRC review of the Viability Assessment
- DOE also proposes a series of interactions to discuss information contained in the reports and to respond to NRC questions or comments
 - In general, the focus would be on topics or issues identified by NRC as important to completing its sufficiency comments

DOE-NRC Interactions on Key Technical Documents for SR

(Continued)

- Relevant DOE technical documents for the SRCR include:
 - Yucca Mountain Site Description
 - Process Model Reports (PMRs) and appropriate Analysis and Model Reports (AMRs)
 - Total System Performance Assessment (TSPA)-SR
 - Appropriate System Description Documents (SDDs) and key supporting design analyses and reports
 - Repository Safety Strategy (RSS)
- Technical documents for SR form the foundation for the technical documents supporting LA

Proposed Document Availability and Interaction Schedule

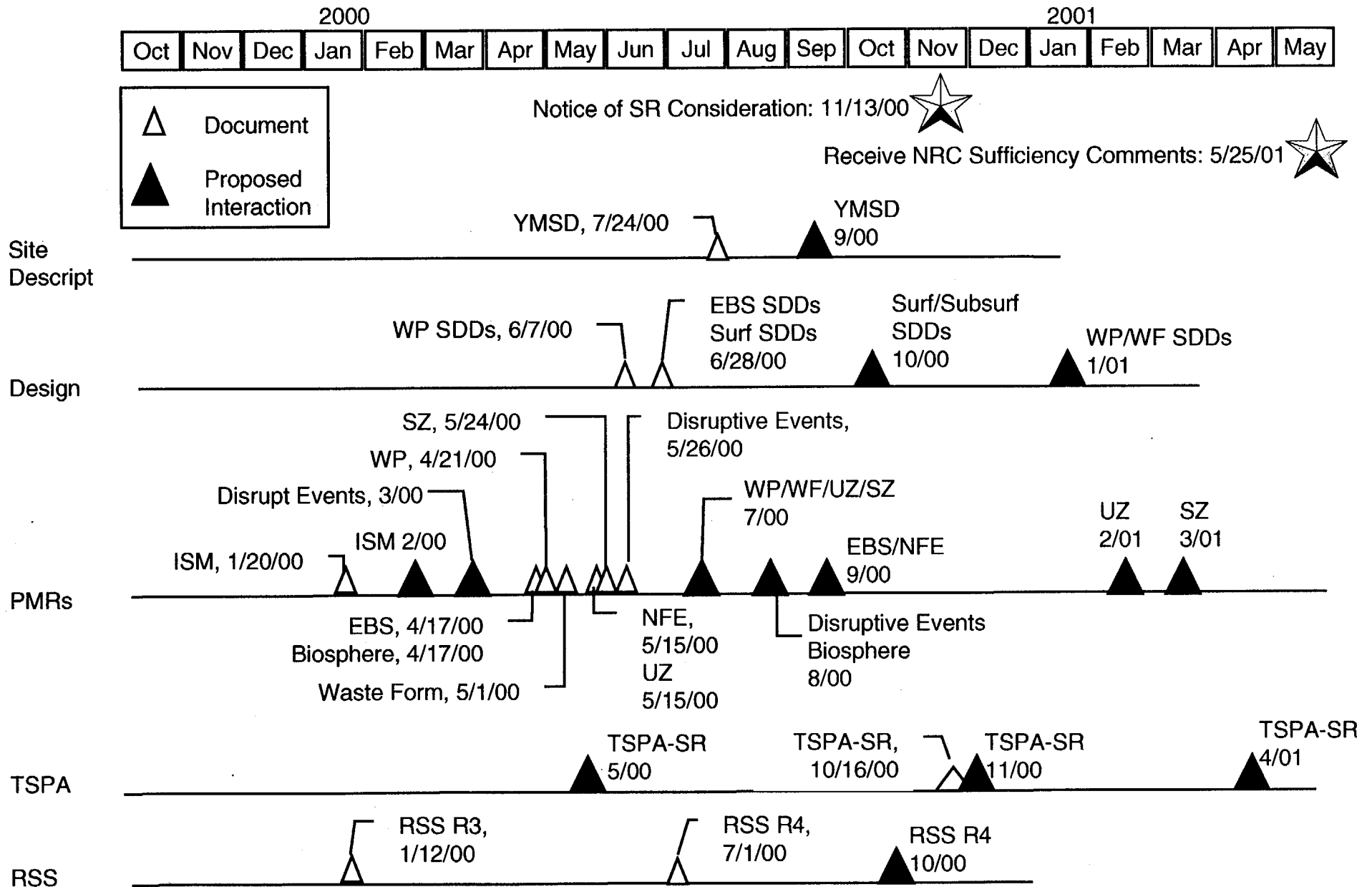

Quality Program Initiatives

- Data verification/qualification got off to a slow start, but recent process refinements focused the work and improved efficiency
- The Principal Factors of the postclosure safety case provide a framework to prioritize the qualification of inputs for PMRs and AMRs to focus on the most important data
- Significant progress has been made on resolution of outstanding CARS
- We are continuing to refine our work processes based on lessons learned as we implement the procedures developed under PVAR

Repository Safety Strategy

- The RSS provides a framework for identification of the Principal Factors of the postclosure safety case
 - RSS Rev. 3 updates Rev. 2 through incorporation of the enhanced design concept selected in 9/99 and preliminary analyses based on this design
 - A draft version of Rev. 3 was used as a basis for FY 00 planning
 - The Principal Factors provide a basis for the prioritization of work on qualification of data inputs

Repository Safety Strategy

(Continued)

- DOE agrees with the approach and prioritization of factors presented in RSS Rev. 3; however, the document is being revised to enhance clarity and traceability before being issued
 - RSS Rev. 3 will be completed in 1/00
 - The analyses presented in Rev. 3 are preliminary, based on VA models and the revised design concept
 - The full technical basis for the Principal Factors will be included in the PMRs
 - The safety strategy will be revised if necessary, and its technical basis will be complete and fully traceable for the SRCR

Summary

- Current Project focus is on completion of the FEIS and preparation of the SRCR and its supporting documents, consistent with our quality goals
- Technical documents supporting the SRCR will be made available to the NRC and the public as they are completed
- Interactions with NRC in FY00-01 will focus on the technical basis documents that support SR

A Look Ahead

- Status of PMR/AMR Development
- Repository Safety Strategy
- Status of data verification/qualification, prioritization for qualification of inputs, and PMR quality goals
- Deficiency closure status
- Status of PVAR implementation, timeliness of corrective actions, and performance metrics
- Status of scientific notebook reviews and corrective actions
- Results of PMR audits and new supplier issues

YUCCA MOUNTAIN PROJECT



Yucca Mountain Project Status

- Status of Process Model Report/Analysis and Model Report Development

Presented to:

NRC/DOE Management/Quality Assurance Meeting

Presented by:

Richard E. Spence

Deputy AM, Office of Project Execution

December 16, 1999

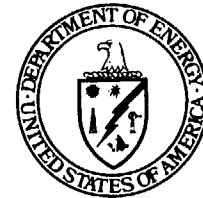

U.S. Department of Energy
Office of Civilian Radioactive
Waste Management

SDD/AMR/PMR/TSPA Relationship

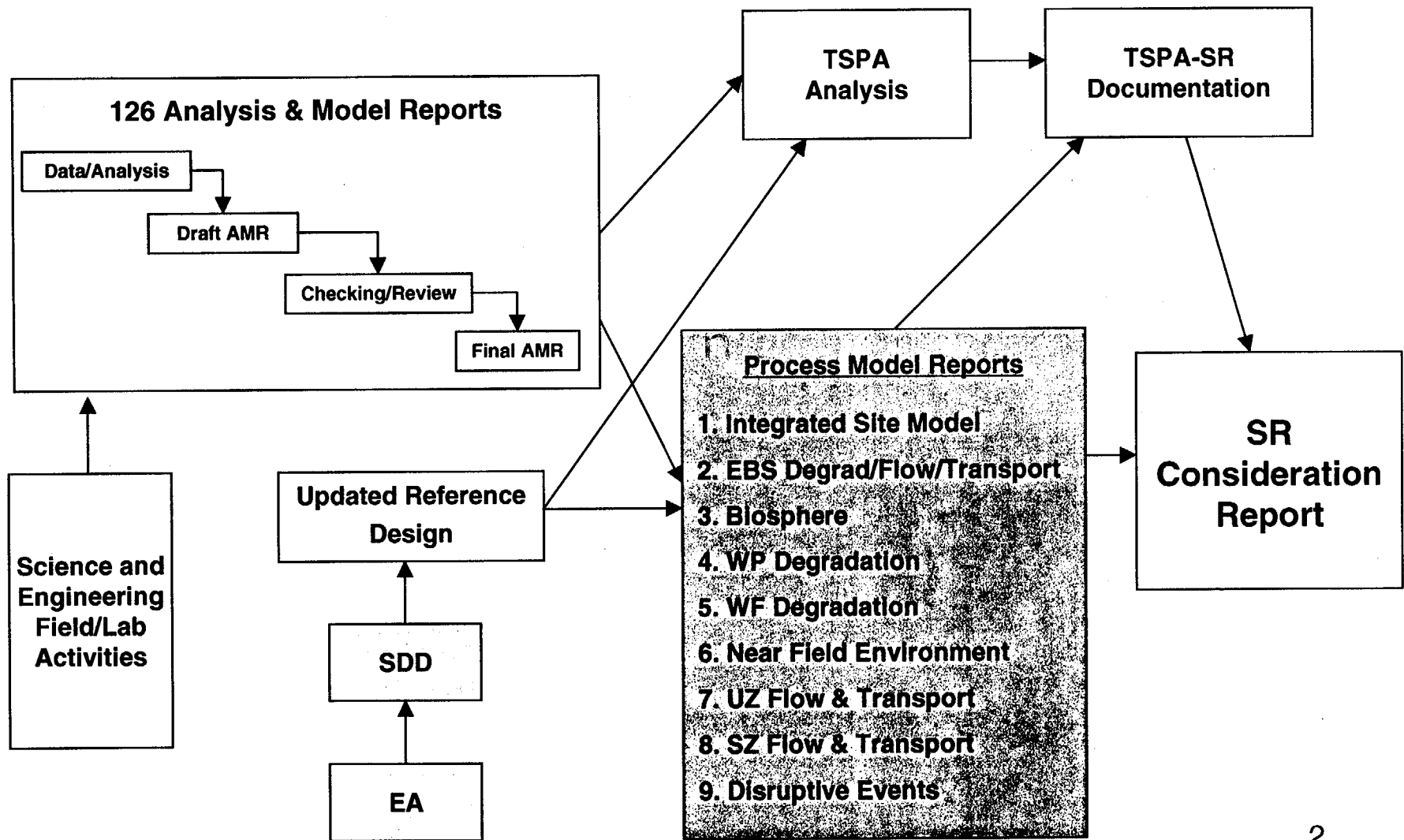

AMR (Rev. 0) Preparation Status

(as of November 30, 1999)

<u>PMR</u>	<u>Number of AMRs</u>	<u>Activities Completed</u>			
		<u>Analysis</u>	<u>Draft Report</u>	<u>Check/Review</u>	<u>Final</u>
Integrated Site Model	3	3	3	3	3
EBS Degrad/Flow/Transp	23	23	7	7	3
Biosphere	15	13	11	7	4
Waste Package Degrad.	14	11	11	8	1
Waste Form Degrad.	23	21	17	7	
Near Field Environment	4	2	1	1	
UZ Flow & Transport	24	21	19	10	1
SZ Flow & Transport	12	12	8	5	2
Disruptive Events	8	6	4		
TOTALS	126	112	81	48	14

PMR (Rev. 0) Completion Schedule

<u>PMR</u>	<u>Scheduled DOE Acceptance</u>
- ISM	12/1/99
- Engineered Barrier System Degradation/Flow/Transport	4/17/00
- Biosphere	4/17/00
- Waste Package Degradation	4/21/00
- Waste Form Degradation	4/28/00
- Near Field Environment	5/15/00
- Unsaturated Zone Flow & Transport	5/15/00
- Saturated Zone Flow & Transport	5/24/00
- Disruptive Events	5/26/00

Process Model Reports

- The Integrated Site Model PMR Rev.0 was completed by the M&O on November 19, 1999
 - The report was conditionally accepted by DOE on 12/13/99
- This report addresses the following three models:
 - Geologic Framework Model
 - Mineralogic Model
 - Rock Properties Model
- These models provide input to the Unsaturated and Saturated Zone Flow and Transport Models

MOUNTAIN SITE RECOMMENDATION SCHEDULE STATUS AS OF 11/30/99

PROCESS MODEL REPORTS 0 10% 20% 30% 40% 50% 60% 70% 80% 90% 100%

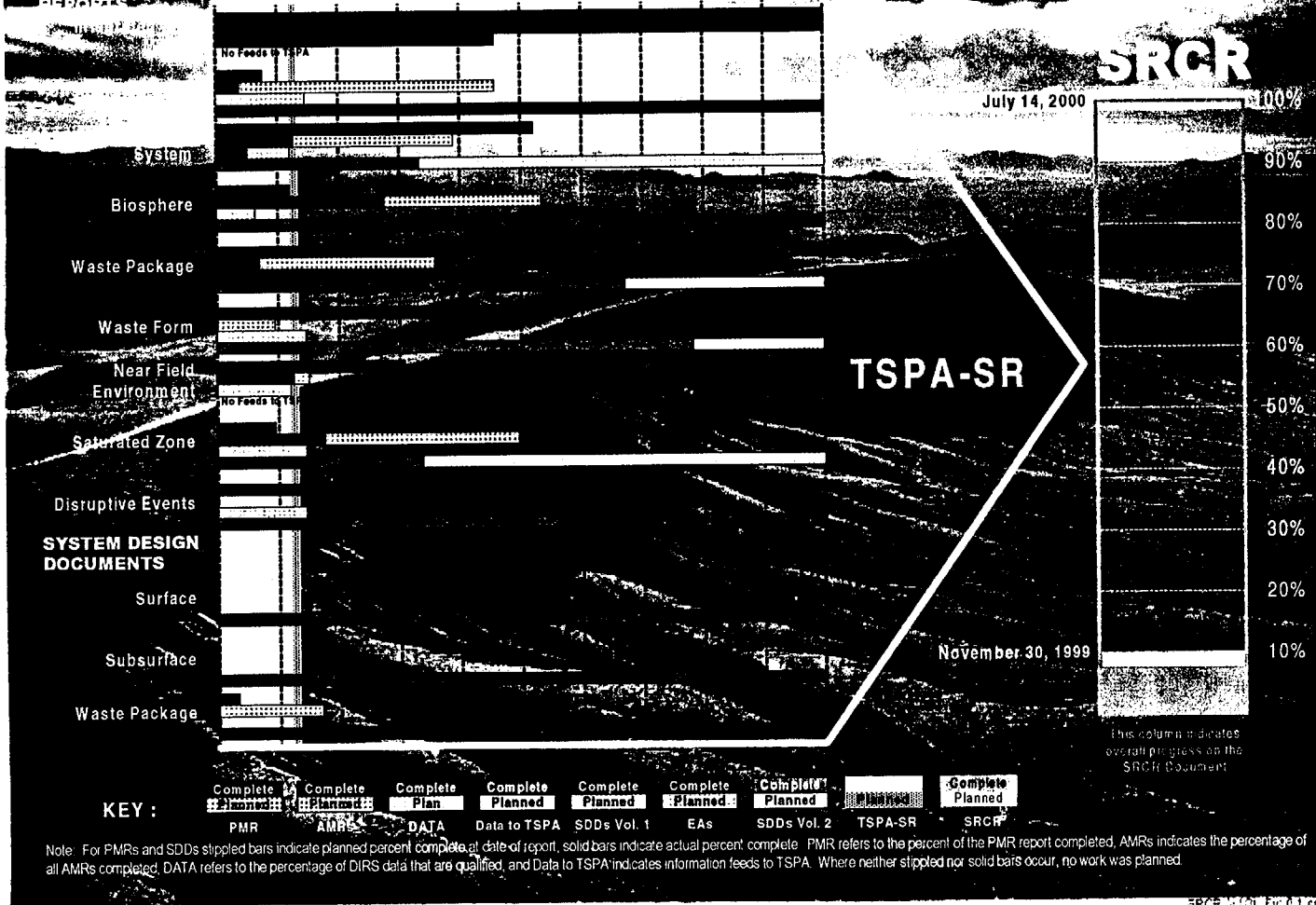

SRCP V.1.01 Fig. 0.1.02

YUCCA MOUNTAIN PROJECT



Yucca Mountain Project Status

- Repository Safety Strategy

Presented to:
NRC/DOE Management/Quality Assurance Meeting

Presented by:
Jack N. Bailey
Director, Regulatory and Licensing, M&O

December 16, 1999

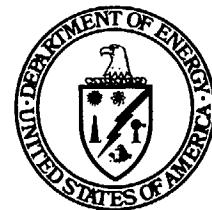

U.S. Department of Energy
Office of Civilian Radioactive
Waste Management

Role of the Repository Safety Strategy

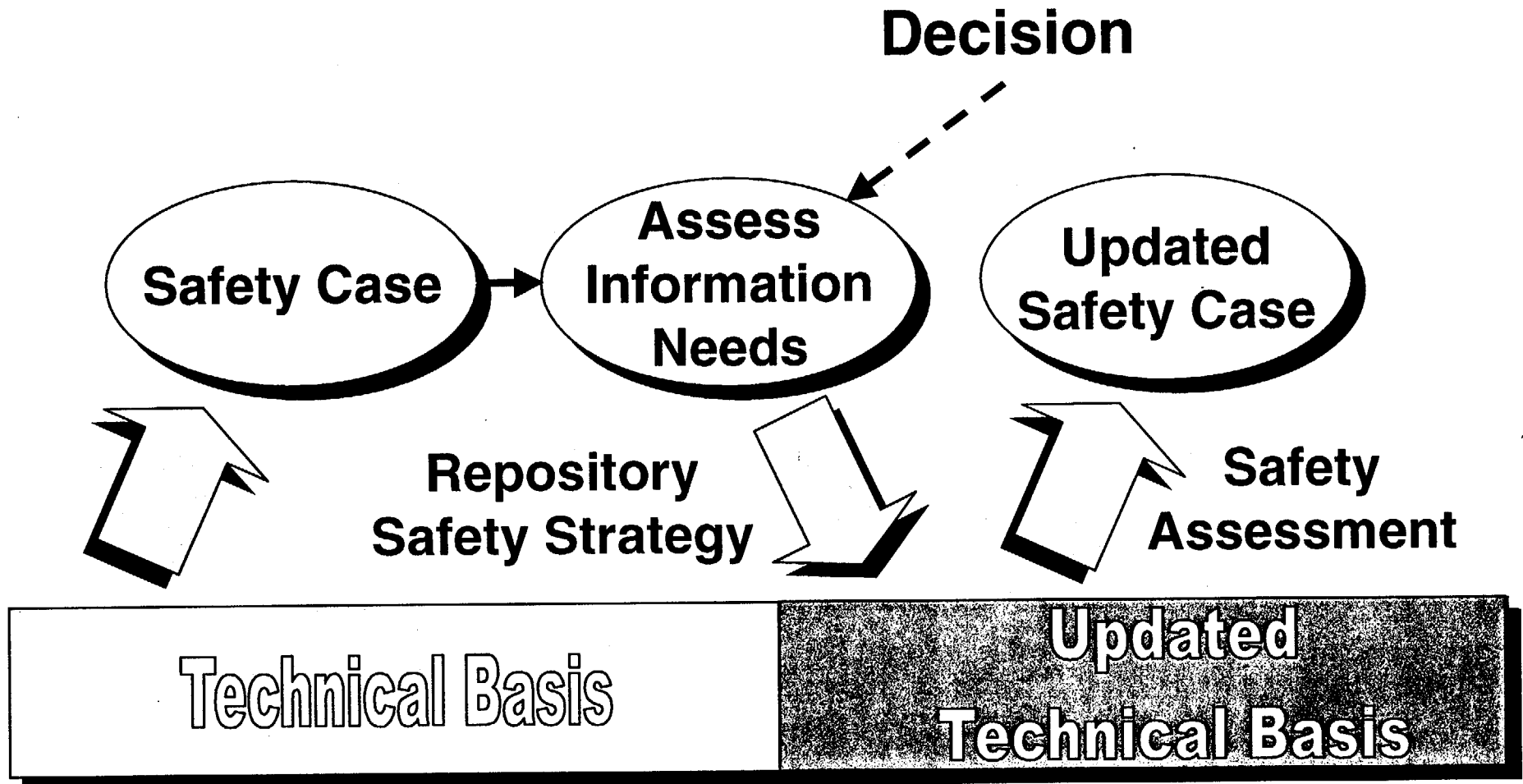

Repository Safety Strategy, Revision

Focuses on SR/LA Considerations

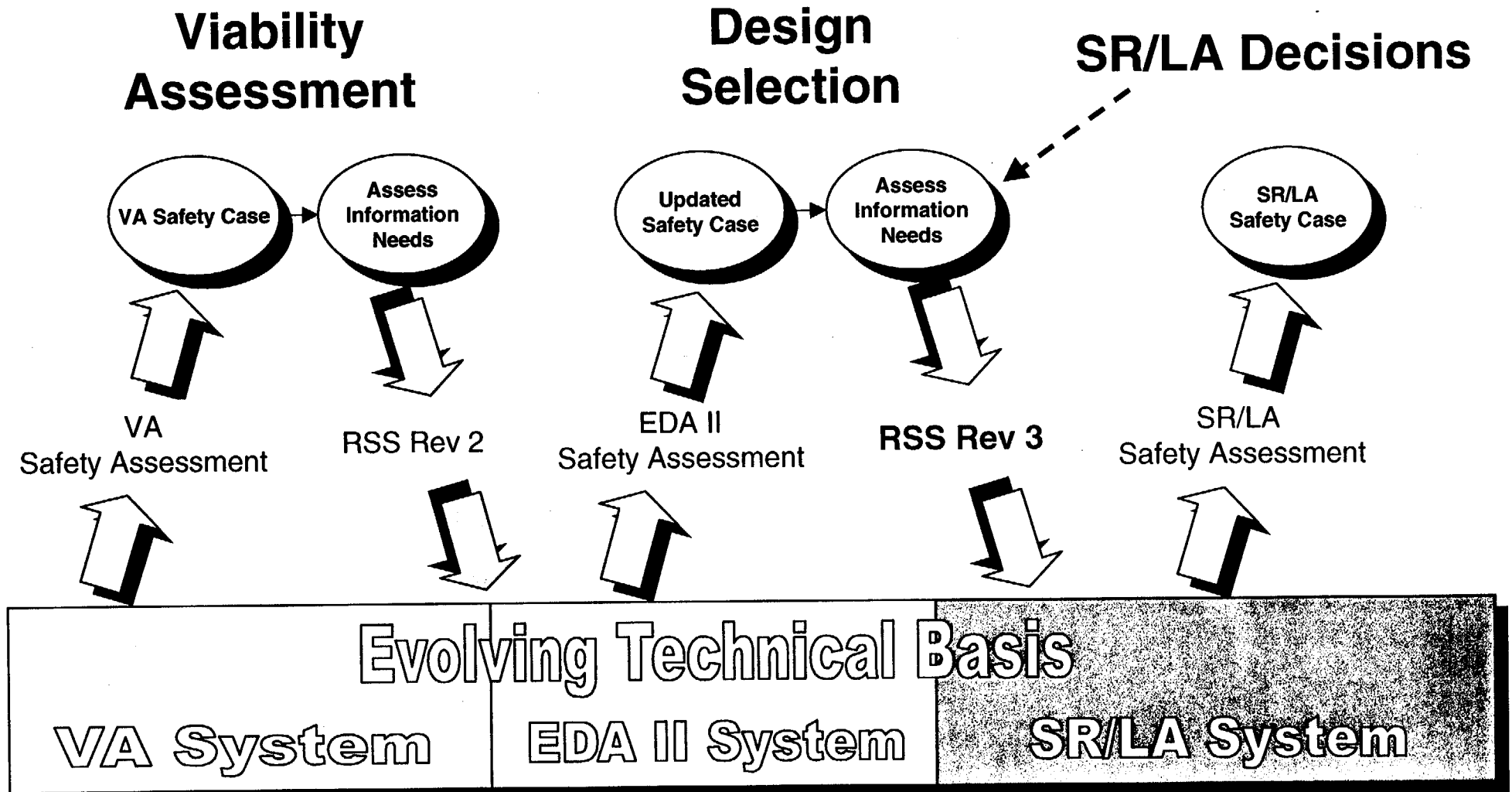

Repository Safety Strategy, Revision 3

(Continued)

- **Safety Case for SR/LA**
 - Summarizes the current status of the Safety Case for SR/LA
 - Evolving site knowledge
 - Changed regulatory framework
 - Enhanced repository design
 - More robust waste package
 - Drip shield for defense-in-depth
 - Backfill to protect waste package and drip shield
 - Develops the basis for the Principal Factors affecting postclosure safety

Repository Safety Strategy, Revision 3

(Continued)

- Safety Case for SR/LA (Continued)
 - Identifies the areas of work necessary to complete the Safety Case for SR/LA
 - Serves as the technical underpinning for prioritization of work for the SR and for grading of data for qualification

Repository Safety Strategy, Revision 3

Updated Factors

- Development of Principal Factors
 - Evaluated nominal and early waste package failure scenarios with EDA II Design
 - Preliminary performance assessments
 - Preliminary barrier importance analyses
 - Broad review by principal investigators and Performance Assessment personnel to ensure the Principal Factors considered:
 - Model uncertainties and limitations of preliminary analyses

Repository Safety Strategy, Revision 3

Updated Factors

(Continued)

- Broad review by principal investigators (Continued)
 - Model uncertainties and limitations of preliminary analyses
 - Current confidence in representation of the factors
 - Information needed to address current issues associated with the factors and the way representations of the less important factors might be simplified
- Review identified factors with potential for enhanced repository performance given additional work
- Disruptive processes and events not yet included

Current Understanding of YM Performance

- Two categories of radionuclides
 - Relatively immobile (>99% of inventory)
 - Relatively mobile (I-129, Tc-99, those transported colloidally)
- Yucca Mountain natural barriers alone limit risk from first category
 - Low solubility, negligible concentrations in YM water
 - Migration highly retarded by sorption at YM

Current Understanding of YM Performance

(Continued)

- Integrated natural and engineered barriers limit risk
 - Arid site, natural barriers limit water reaching and ultimately seeping into emplacement drifts
 - Long-lived waste package limits exposure of waste
 - Drip shield over waste package provides defense-in-depth

Current Understanding of YM Performance

(Continued)

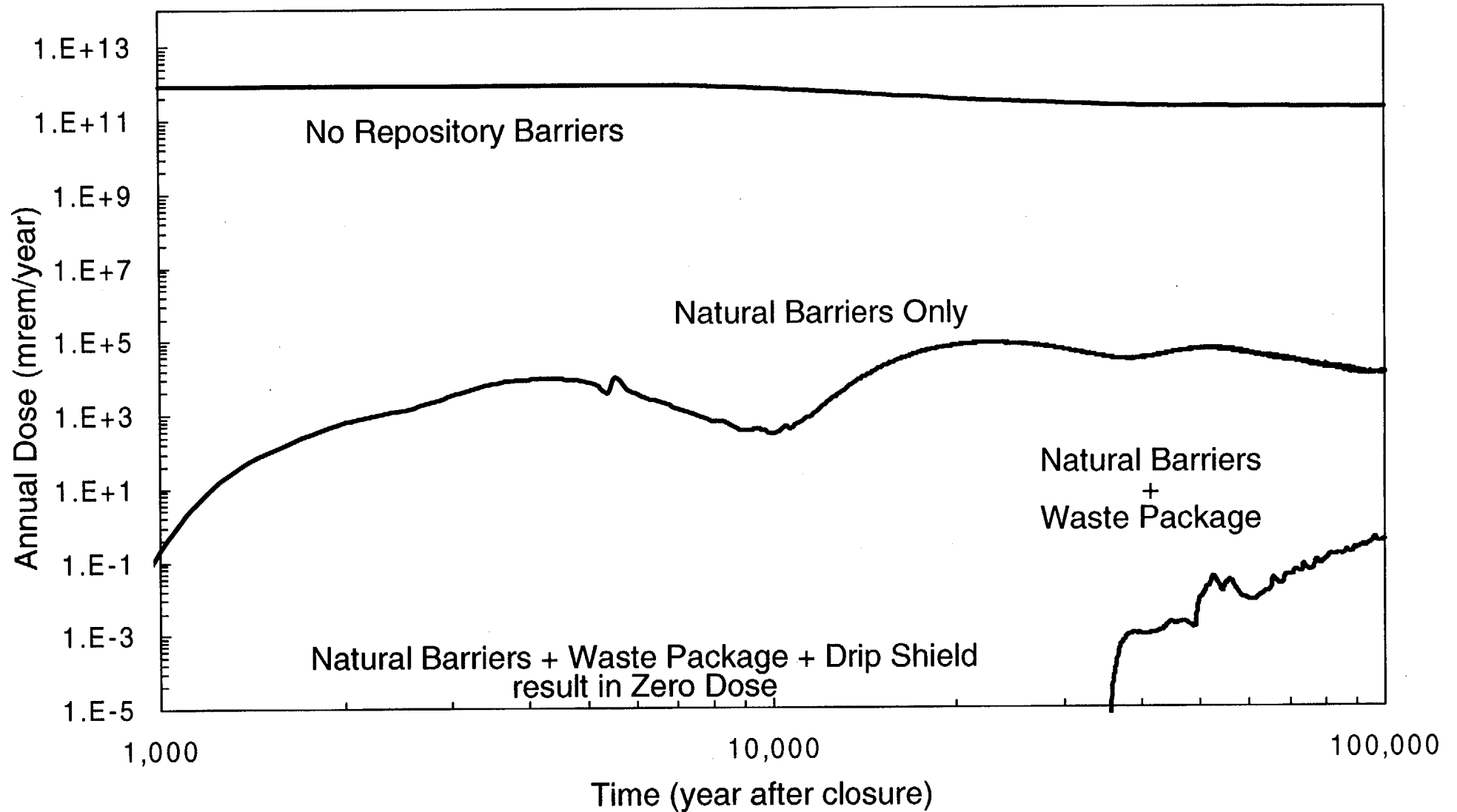

Current Understanding of YM Performance

(Continued)

- System utilizes multiple natural and engineered barriers to ensure postclosure safety
- Natural barriers effective - reduce estimated dose rate by eight orders of magnitude
- Remaining dose rate due to small number of relatively mobile radionuclides

Current Understanding of YM Performance

(Continued)

- Effective waste package and drip shield are utilized to address this residual
 - Base case gives zero release for at least 10,000 years
 - Neutralization of all barriers except waste package and drip shield also give zero release
 - Other barriers are of minor importance or are backed up by remaining barriers

Preliminary Barrier Importance Analysis

- Assessed effectiveness of engineered and natural barriers on dose released to the environment
- Used EDA II model as the starting point. EDA II is based on TSPA-VA design enhanced as follows:
 - Lower thermal loading
 - Waste packages in line loading configuration
 - “Inside out” VA waste package design
 - Titanium grade 7 corrosion-resistant drip shield
 - Backfill

Preliminary Barrier Importance Analysis

(Continued)

- Computation system same as TSPA-VA
- Importance of different factors evaluated by neutralizing them (rendering them ineffective as barriers to flow and transport of radionuclides)

Preliminary Barrier Importance Analysis

(Continued)

Base Case

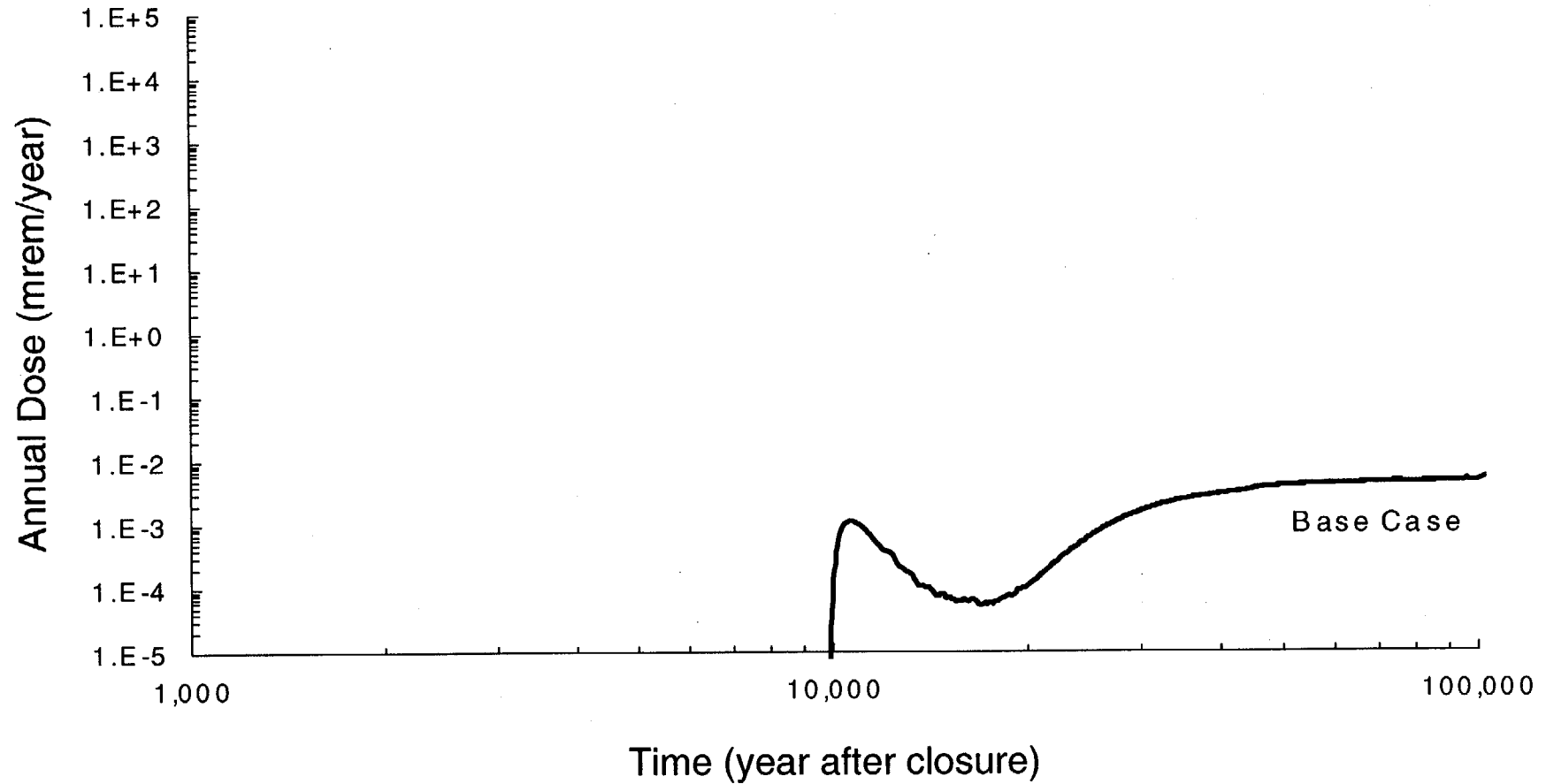

Preliminary Barrier Importance Analysis

(Continued)

Neutralize Overlying Rock Flow Barrier

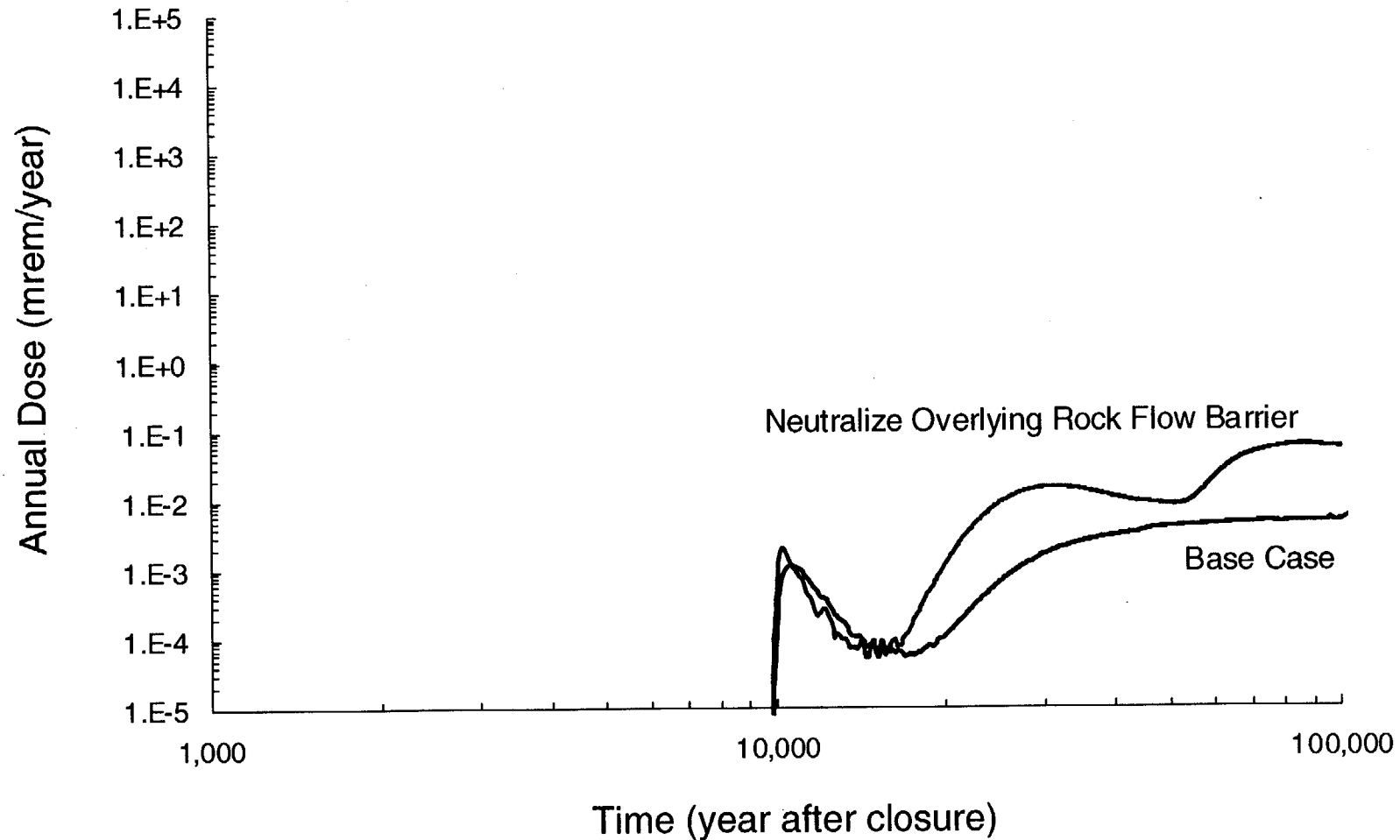

Preliminary Barrier Importance Analysis

(Continued)

Neutralize Concentration Limits

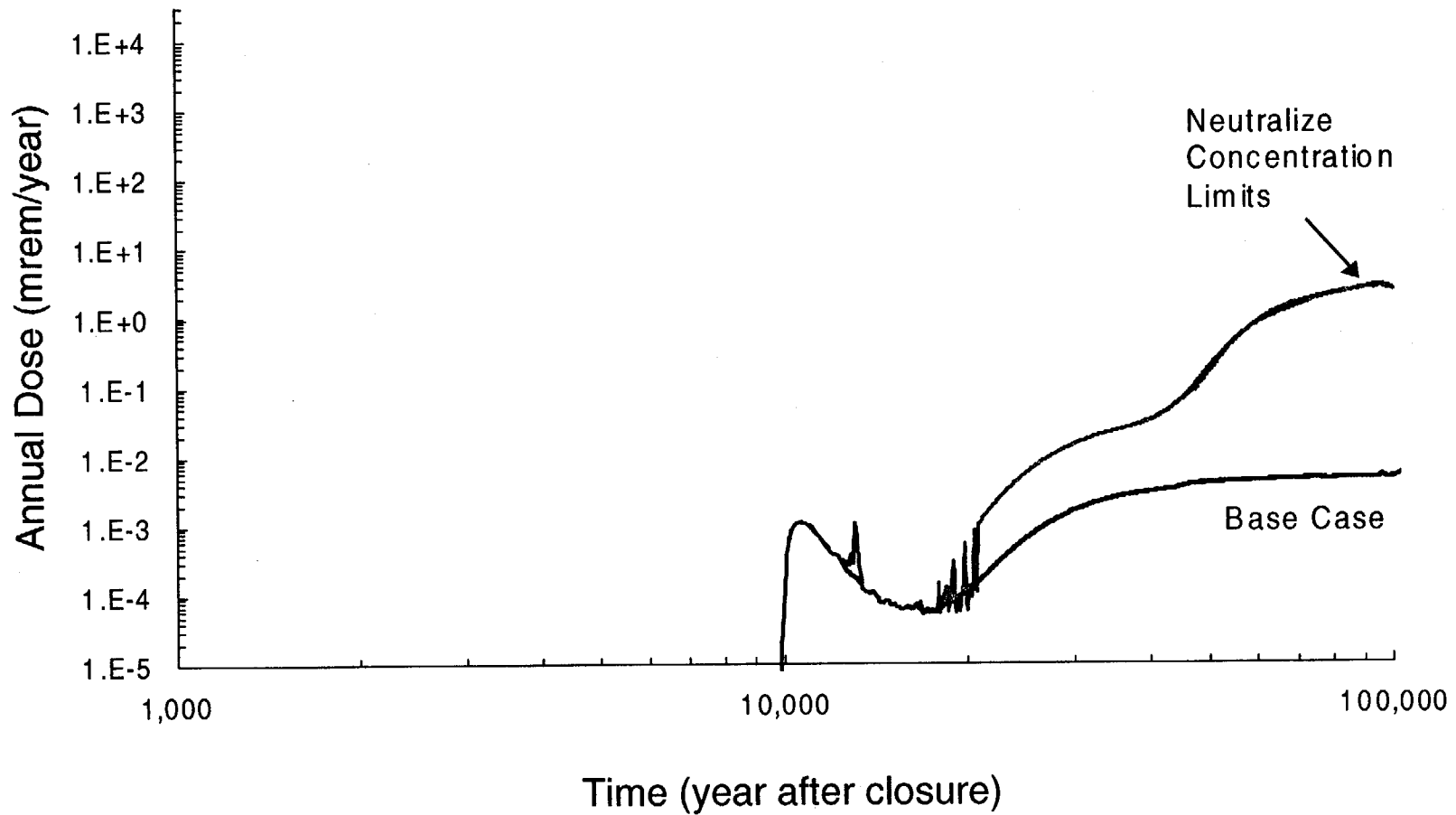

Preliminary Barrier Importance Analysis

(Continued)

Neutralize Unsaturated Zone Transport Barrier

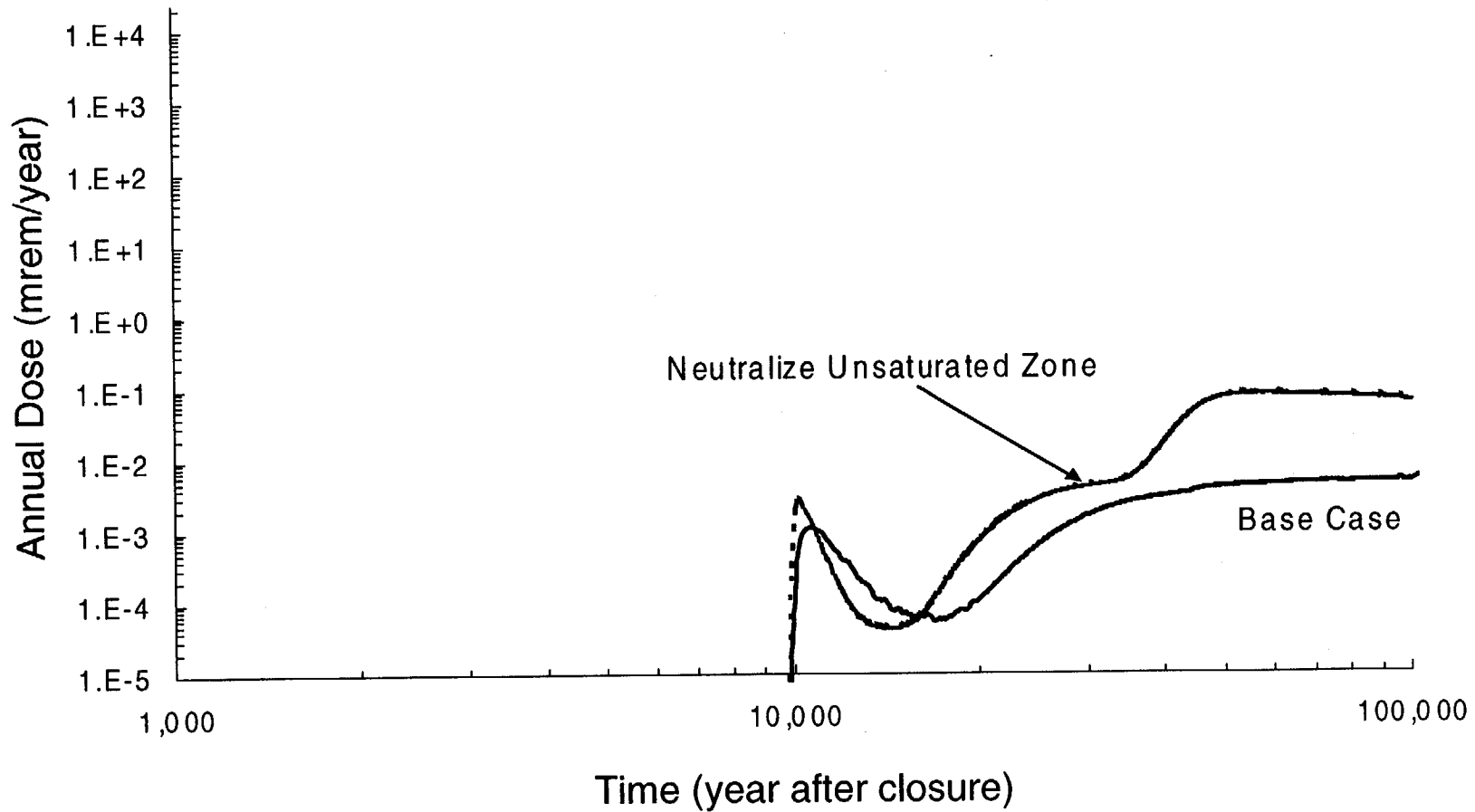

Preliminary Barrier Importance Analysis

(Continued)

Neutralize Saturated Zone Transport Barrier

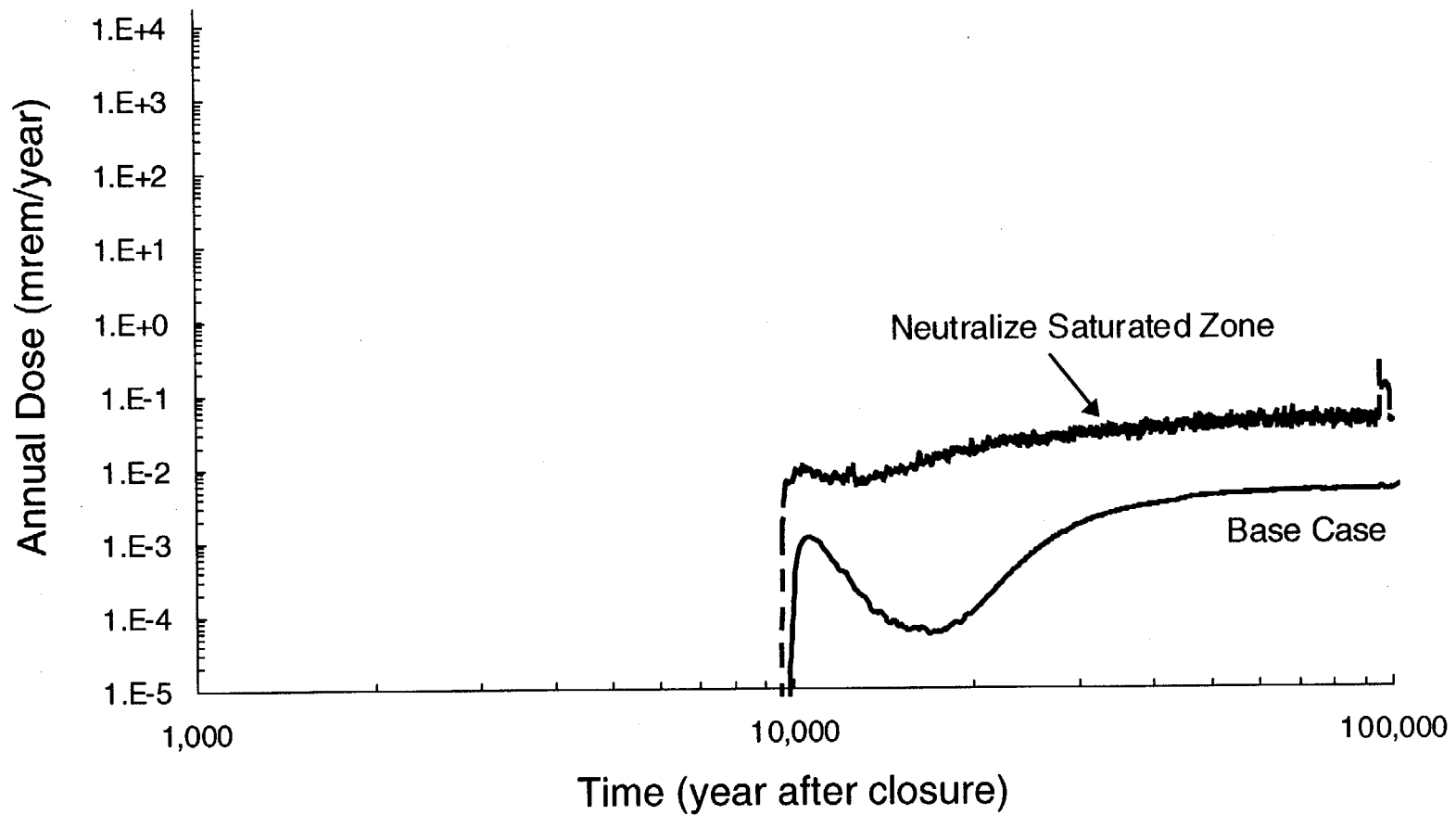

Preliminary Barrier Importance Analysis

(Continued)

Neutralize Retardation in both SZ and UZ

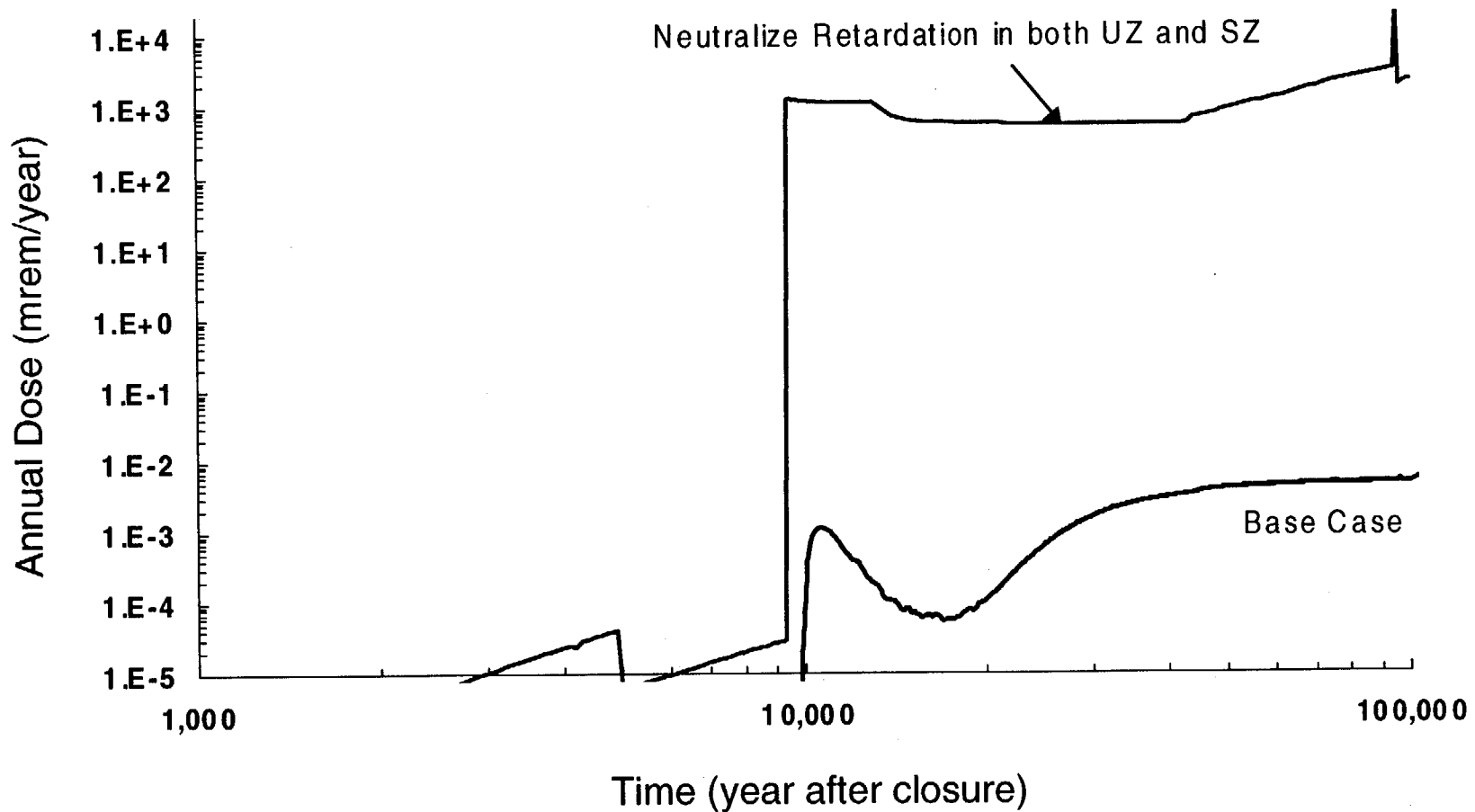

Preliminary Barrier Importance Analysis

(Continued)

Early Waste Package Failure Scenario

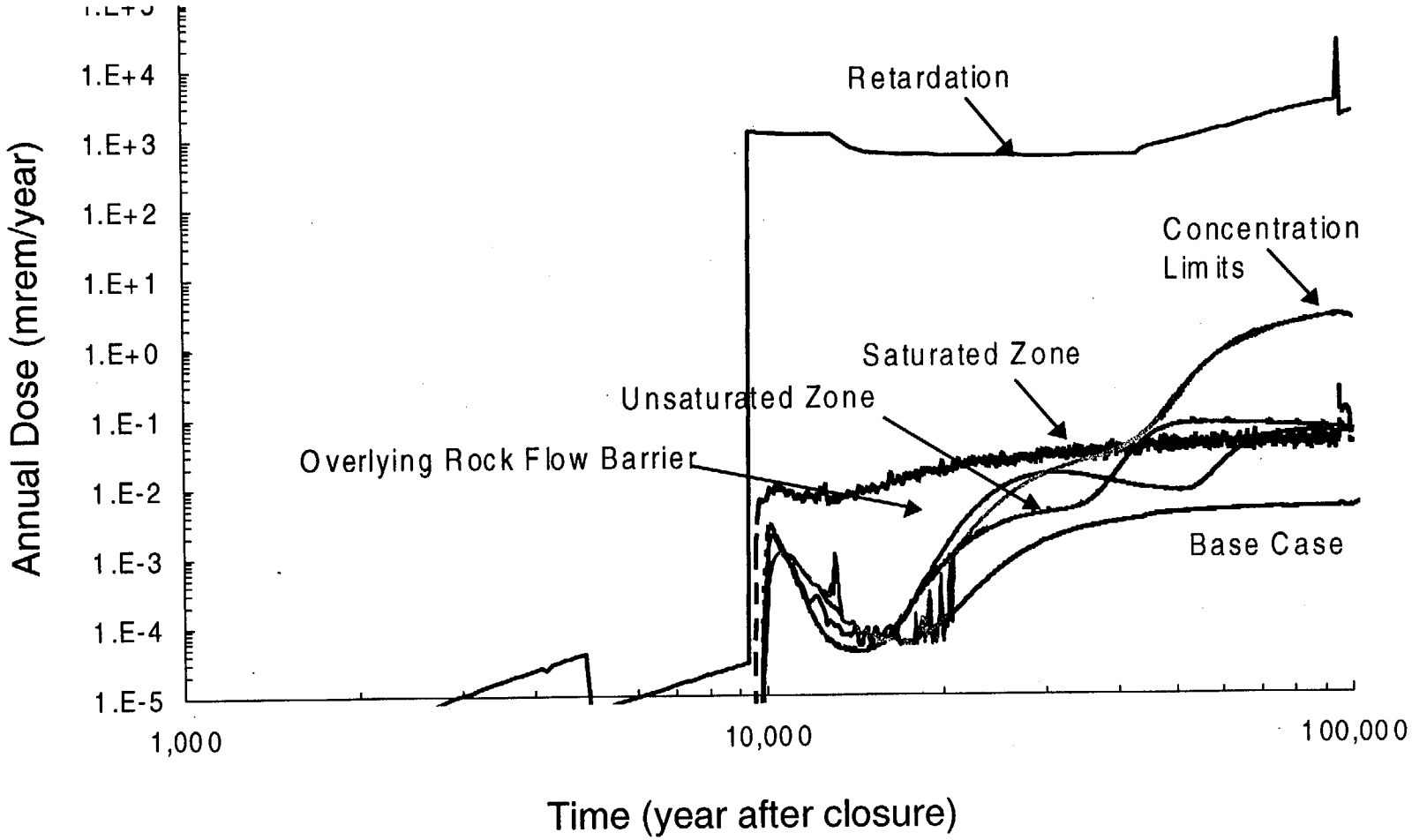

Preliminary Barrier Importance Analysis

(Continued)

- General understanding Early Waste Package Failure Scenario
 - Even for early-failed waste package, release does not begin till ~10,000 years (until after first drip shield fails)
 - Neutralization of individual natural barriers gives minor changes
 - Neutralization of retardation in UZ and SZ at same time gives a major change
 - Neutralization of concentration limits of less importance, but considerations still warranted

Repository Safety Strategy, Revision 3 Updated Factors

Key Attributes	Factors for Enhanced System Design
Water Contacting Waste Package	Climate
	Net infiltration into the mountain
	UZ flow above repository
	Seepage into drifts
	Coupled processes - effects on UZ flow
	Coupled processes - effects on seepage
	Environments on drip shield
Waste Package Lifetime	Performance of drip shield
	Environments on waste package
Radionuclide Mobilization and Release from the Engineered Barrier System	Performance of waste package barriers
	Environments within waste package
	CSNF waste form performance
	DSNF, Navy fuel, Pu disposition waste form performance
	DHLW glass waste form performance
	Solubility limits of dissolved radionuclide
	Colloid-associated radionuclide concentrations
	In-package radionuclide transport
Transport through the drift invert	
Transport Away from the Engineered Barrier System	Advective pathways in the UZ
	Retardation of radionuclide migration in UZ
	Colloid-facilitated transport in the UZ
	Coupled processes--effects on UZ transport
	Advective pathways in SZ
	Retardation of radionuclide migration in SZ
	Colloid-facilitated transport in SZ
	Dilution of radionuclide concentration in UZ and SZ
Biosphere transport and uptake	

Principal Factors

Seepage into drifts

Performance of drip shield

Performance of waste package barriers

Solubility limits of dissolved radionuclides

Retardation of radionuclide migration in UZ

Retardation of radionuclide migration in SZ

Dilution of radionuclide concentration in UZ and SZ

Robust Safety Case for SR/LA

- TSPA
 - Factors potentially contributing to postclosure performance
 - Perform sensitivity and uncertainty analyses
- Safety Margin and Defense-in-Depth
 - Enhanced design
 - No undue reliance on any single element of the system
 - Assess contribution and significance of barriers

Robust Safety Case for SR/LA

(Continued)

- Disruptive Processes and Events
 - Quantitative inclusion of FEPs in overall TSPA
 - Qualitative assessment of key scenarios, e.g., seismic activity, igneous activity, nuclear criticality
- Insights from Natural Analogues
- Performance Confirmation

The Evolving Repository Safety Strategy

- The RSS will be updated after initial analyses for SR to incorporate parameter and model uncertainty and screening of FEPs
- This update will document Principal Factors for SR Safety Case
- This update will also document areas where additional simplification would be appropriate for LA Safety Case
- Design evolution and performance confirmation may require additional updates

Summary

- Repository Safety Strategy, Revision 3 identified seven Principal Factors
 - Enhanced Repository System for SR has 27 factors
 - List expanded to address lower level of detail
 - Added engineered system components
 - Addressing opportunities for enhanced performance credit (e.g., seepage, cladding, stainless steel canister as a barrier, matrix diffusion)
- Continuing to use TSPA, sensitivity studies, importance analyses, expert judgment to refine the safety case

YUCCA MOUNTAIN PROJECT

Yucca Mountain Project Status

- Status of Data, Model, and Code Qualification/
Validation and Control Plan

Presented to:
NRC/DOE Management/Quality Assurance
Meeting

Presented by:
Rob Howard
Project Manager for Qualification, M&O

December 16, 1999

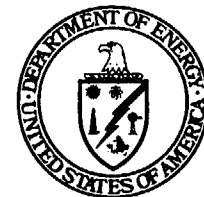

U.S. Department of Energy
Office of Civilian Radioactive
Waste Management

Management Focus

- Achieve quality results
- Data qualification is a high priority for the Program
- Project Manager for data qualification
 - Established October 1999
 - Overall authority, responsibility, and accountability
- Significant progress has been made
 - Strengthened process
 - Data verification & qualification 8/11/99 vs. 12/16/99

<u>08/11/99</u>	<u>12/16/99</u>
1368 DTNs identified	907 DTNs identified
42 complete	184 complete

Project Objectives

- Identify data to be verified/qualified
- Verify/qualify data
- Control

Prioritizing/Grading

- Regulatory framework acknowledges grading
 - NUREG-1318
 - *“Adequate confidence in the quality of the items and activities within the scope of the QA program may be obtained with graded QA measures.”*
 - *“It is expected that safety analyses can provide evaluations of the importance to safety and/or waste isolation in particular structures, systems, or components. These evaluations can provide a logical framework for application of graded QA measures.”*

Prioritizing/Grading

(Continued)

- **Regulatory framework** (Continued)
 - NUREG-1318 states QA controls should be applied to data collection and analyses activities
 - Consistent with use and as understanding of system performance improves
 - Vary in degrees of importance to safety or waste isolation
 - Risk assessments can provide framework for grading

Prioritizing/Grading

(Continued)

- OCRWM QARD provides for applying QA controls to the degree commensurate with
 - Function or end use
 - Consequence of failure (risk)
 - Importance of data collected or analyzed
- QARD stipulates data directly relied on to address safety and waste isolation issues shall be qualified from origin, accepted, or undergo qualification

Prioritizing/Grading

(Continued)

- **General approach**
 - PMRs and Analysis & Model Reports (AMRs) map to principal factors
 - Evaluate AMRs with respect to their effect on principal factors
 - Evaluate inputs to AMRs based on use and effects on conclusions (AMR authors)
 - Apply resources based on priorities
 - Limit additional verification to data supporting principal factors based on grading results

Prioritizing/Grading

(Continued)

- Data verification activities focused (revised verification checklist)
- Data used as direct input to Principal Factors will be qualified and have verification checklist applied
- Data for non-principal factors also qualified but will not have verification checklist applied
- Verification results to date
 - Very low rate of qualification status change to date - “process QA” oriented
 - Minor evidence of technical issues

Prioritizing/Grading

(Continued)

- Principal Factors (RSS, Revision 3)
 - Seepage into drifts
 - Performance of drip shield
 - Performance of waste package barriers
 - Solubility limits of dissolved radionuclides
 - Retardation - radionuclide migration in UZ
 - Retardation - radionuclide migration in SZ
 - Dilution of radionuclide concentration in UZ and SZ

PMR PEMP* Quality Goals

Action	PMR Rev. 0	PMR Rev. 1	PMR Rev. 2
Verification (qualification status verified) of data inputs to PMRs and AMRs	50%	90%	Completed based on repository safety strategy
Qualified data	40%	80%	Completed based on repository safety strategy
Qualified software codes	40%	80%	Completed based on repository safety strategy

* Performance Evaluation Management Program

Inventory Management & Metrics

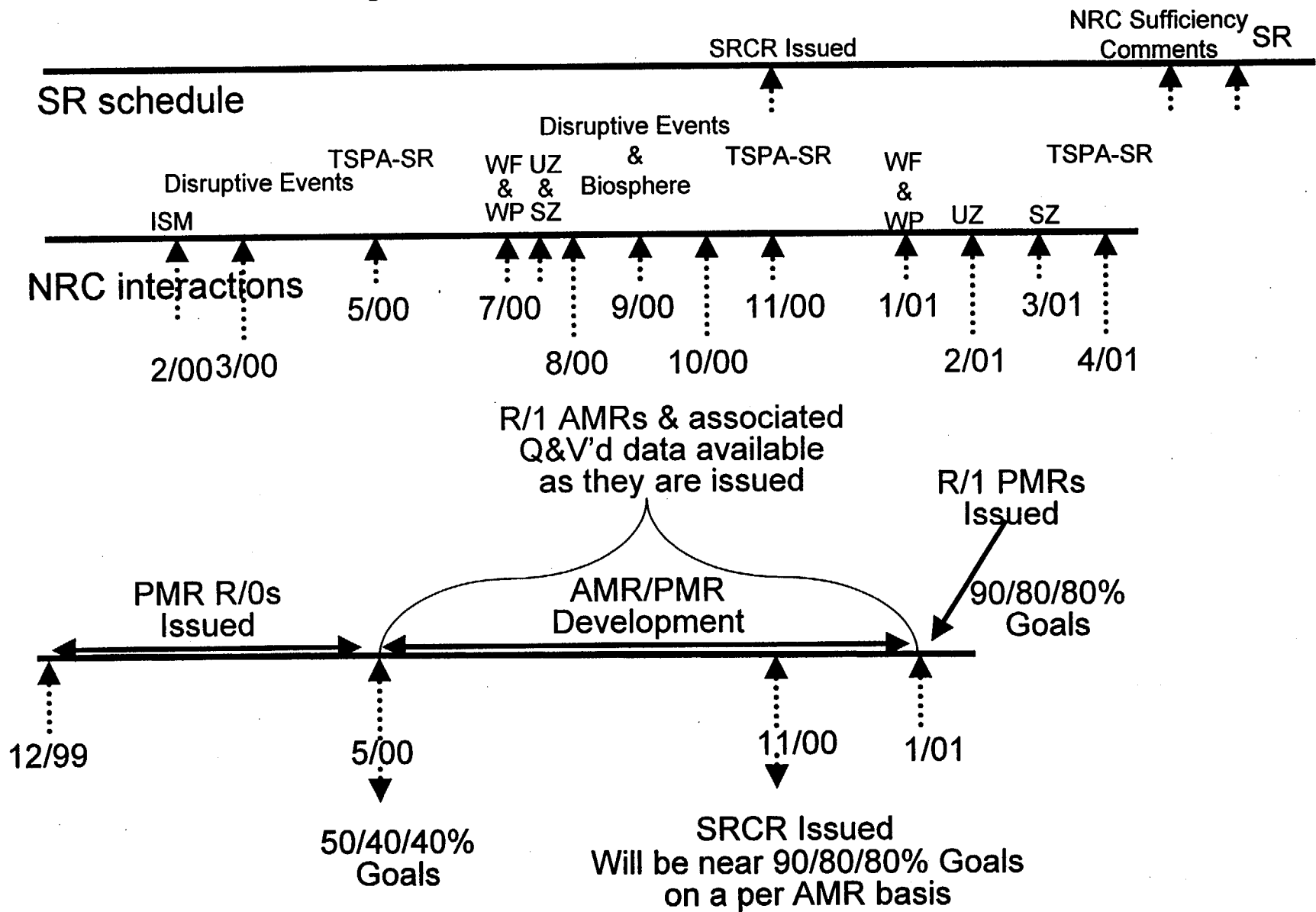

Inventory Management & Metrics

(Continued)

Preliminary Data Call 06/99

ID 1368 DTNs
 166 AMRs
 9 PMRs

51 Software Codes

Draft AMRs/PMRs As of 12/99

ID 907 DTNs
 126 AMRs
 9 PMRs
 Principal Factors
 734 DTNs
 41 AMRs
 7 PMRs
 79 Unique codes

Running Inventory Metrics

<u>Unique PF DTNs</u>	<u>Qualified</u>	
Unique PF DTNs	<u>174</u>	24%*
	734	
<u>Unique non-PF DTNs</u>	<u>Qualified</u>	
Unique non-PF DTNs	<u>2</u>	1%
	173	
<u>Total Unique DTNs</u>	<u>Complete</u>	
Total Unique DTNs	<u>176</u>	19%*
	907	
Software	<u>60 Complete</u>	75%
	79 Total Codes	

* Does not include 8 DTNs with status change from Q to non-Q

Current workload inventory

- Based on latest draft of inputs to AMRs
- Confidence increase early-CY00 as inputs completed

Inventory Management & Metrics

(Continued)

- Prior estimates based on early data needs
- Now using identification of actual data inputs as AMRs are developed
- Actual inputs only confirmed near end of each AMR preparation, before checking
- Input inventory totals will change and firm-up as inputs are prepared

Inventory Management & Metrics

(Continued)

- Two levels of data feeds; both under configuration management
 - Direct inputs identified as inputs to AMRs
 - Indirect inputs - data used to develop direct inputs to AMRs
 - Cannot remove direct input TBVs until TBVs for supporting data sets are removed
 - Completion rates for both levels will vary from AMR to AMR
 - Performance goals based on direct input to AMRs

Status Tracking & Management Control

- Data V&Q currently scheduled as level of effort
 - Individual data activities for each AMR
 - Based on qualitative estimates
- Approximate work-off rates reduced from 40-50 hrs/DTN to 16-24 hrs/DTN using refined procedures
- Adjust resources as necessary to
 - reflect improving work-off rates
 - ensure schedule performance

Status Tracking & Management Control

(Continued)

- Track V&Q production on individual AMR basis for each PMR
- Refine data V&Q resource commitments for each AMR when related inputs are confirmed

Significance of Principal Factor Data and Software Not Verified & Qualified by 11/00

Impact management measures in place

- Impact of unqualified data described in AMRs
- Impact of discrete data sets likely minimal as a result of uncertainty distributions and variability incorporated in Performance Assessment abstractions
- Sensitivity analysis for impacts will be performed as needed

Summary

- DOE has made progress
- Slow at first, but work-off rates increasing
- Tools and process in place
- Exact inventory not final until Rev. 0
- Resources will be adjusted to maintain progress
- Confident goals can be met

YUCCA MOUNTAIN PROJECT

Yucca Mountain Project Status

- Deficiency Closure Status

Presented to:
NRC/DOE Management/Quality Assurance Meeting

Presented by:
Richard E. Spence
Deputy AM, Office of Project Execution

December 16, 1999

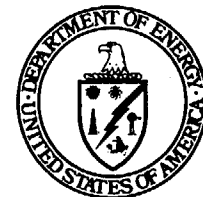

U.S. Department of Energy
Office of Civilian Radioactive
Waste Management

Improvements in Deficiency Closure

- DOE and M&O Line Management Involvement in the DR/CAR Process
- Establishment of the Corrective Action Board (CAB)
- AP-16.1Q, *Management of Conditions Adverse to Quality*, was revised and improved
- Effects of the Nuclear Culture taking hold

Improvements in DRs/CARs

- May 1998 - 84 open YMSCO DRs/CARs
- October 1998 - Peaked at 98 open DRs/CARs
- Since that time, 224 DRs/CARs were processed and closed
- As of December 13, 1999 - Number of open DRs/CARs is 31

Improvements in DRs/CARs

(Continued)

- For the 31 open DRs/CARs,
 - 9 are in the process of verification and closure
 - 22 are in various stages of their resolution cycle leading up to verification
 - The open deficiencies in the resolution cycle have been prioritized in accordance with their impact on the Project

DR/CAR Chart

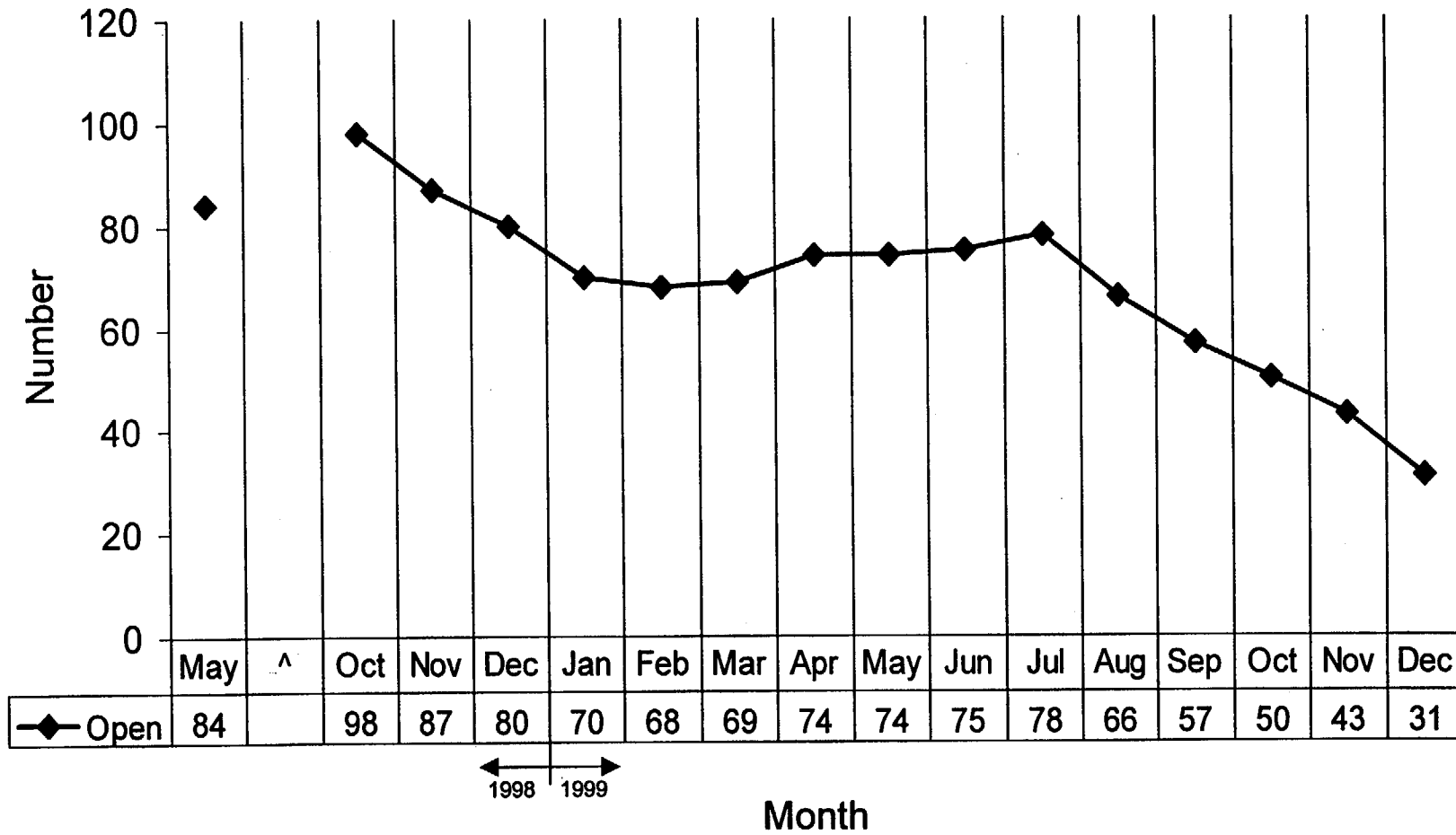

(Chart does not include DRs/CARs issued to EM, HDQTR, or OQA)

YUCCA MOUNTAIN PROJECT

Yucca Mountain Project Status

- Status of PVAR Implementation
- Timeliness of Corrective Actions
- Performance Monitoring/Metrics

Presented to:

NRC/DOE Management/Quality Assurance Meeting

Presented by:

Daniel R. Wilkins

Assistant General Manager, M&O

December 16, 1999

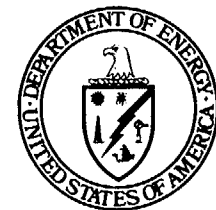

U.S. Department of Energy
Office of Civilian Radioactive
Waste Management

Status of PVAR Implementation

Status of PVAR Implementation

- PVAR procedures were effective 6/30/99
 - 25 new/revised procedures for technical work
- Results of PVAR implementation
 - Approximately 80 procedures have been cancelled, 13 more in the cancellation process
 - PVAR procedures are being used
 - 12 PVAR procedures revised since 6/30/99
 - Improvements continue to be identified (Approximately 45 DARs in process)
 - Procedure changes are being made as necessary (urgent/not urgent)

Status of PVAR Implementation

(Continued)

- Three audits since 6/30/99 related to PVAR
 - Six deficiencies identified
 - No significant conditions adverse to quality identified (no CARs)

OCRWM Lessons Learned Program

- Implemented under Procedure AP-REG-001, *Managing Lessons Learned*, effective 6/30/99
- Provides for identification and communication of positive (Good Practices) and negative (Events and Findings) experiences
- Intended to improve efficiency and cost-effectiveness of the operation, as well as preventing recurrence of undesired conditions
- Lessons Learned published on Intranet

Timeliness of Corrective Action

Timeliness of Corrective Actions

- 6/1/99 to 9/9/99 (100 days) - 26 deficiencies
 - 14 closed within 100 days (Average 59 days)
 - 8 closed by 11/24/99 (Average 125 days)
 - 4 open as of 12/3/99 (Average 155 days)
 - Average age of 22 closed - 83 days
- 6/1/98 to 9/9/98 (100 days) - 30 deficiencies
 - 7 closed within 100 days (Average 85 days)
 - 20 closed by 12/3/99 (Average 250 days)
 - 3 open as of 12/3/99 (Average 501 days)
 - Average age of 27 closed - 207 days

Timeliness of Corrective Actions

(Continued)

- Improvements the result of:
 - Revised AP-16.1Q, *Management of Conditions Adverse to Quality* (Effective 6/1/99)
 - Nuclear Culture Initiatives
 - Corrective Action Board
 - Increased DOE and M&O management attention

Performance Monitoring/Metrics

Performance Monitoring/Metrics

M&O Performance Indicator Report

Section	Indicators
Safety	Total Recordable Injury/Illness Case Incidence Rates 1999 (Cumulative by Month)
	Lost Workday Injury/Illness Case (LWC) Incidence Rates 1999 (Cumulative by Month)
	Ergonomic Evaluations as Compared to Recordable Cases (1996 Cumulative through Current Quarter)
	1999 Estimated Radon Exposure as Compared to ALARA Goals (By Month)
	Environmental Surveillance, Spills, Permit Compliance (1st through 4th Quarters FY99)
Quality	Backlog of M&O Deficiencies (Monthly Activity)
	Backlog of M&O Deficiencies (By Age Categories)
	Percent of M&O Deficiencies Identified by Line Orgs (Six Month Rolling Avg.)
	M&O Self-Assessments (Monthly Activity)
	M&O Self-Assessments Quality Issues Backlog (Monthly Activity for Q-Issues)
	Average Grade of Documents Checked
Production	AMRs That Support PMRs (Total number of scheduled AMRs vs AMRs behind schedule)
	AMR/PMR Data, Model, and Software Code Qualification/Validation (Totals) (EXAMPLE)
	System Description Documents (SDDs) That Support PMRs (% on schedule & behind schedule)
	Integrated Safety Mgmt. Implementation Gaps Open & Closed, by Month (EXAMPLE)
Cost	YMP FY99 ACWP, BCWS, & BCWP
	Performance by Product
	Performance for Site Recommendation

Performance Monitoring/Metrics

M&O Performance Indicator Report

(Continued)

- Distributed electronically each month
- Published on the M&O Intranet
- Posted on Management bulletin board
- Each indicator includes synopsis of month's performance, identification of trends, and any necessary corrective actions
- Indicators in place by end of September 1999

Backlog of M&O Deficiencies (Monthly Activity)

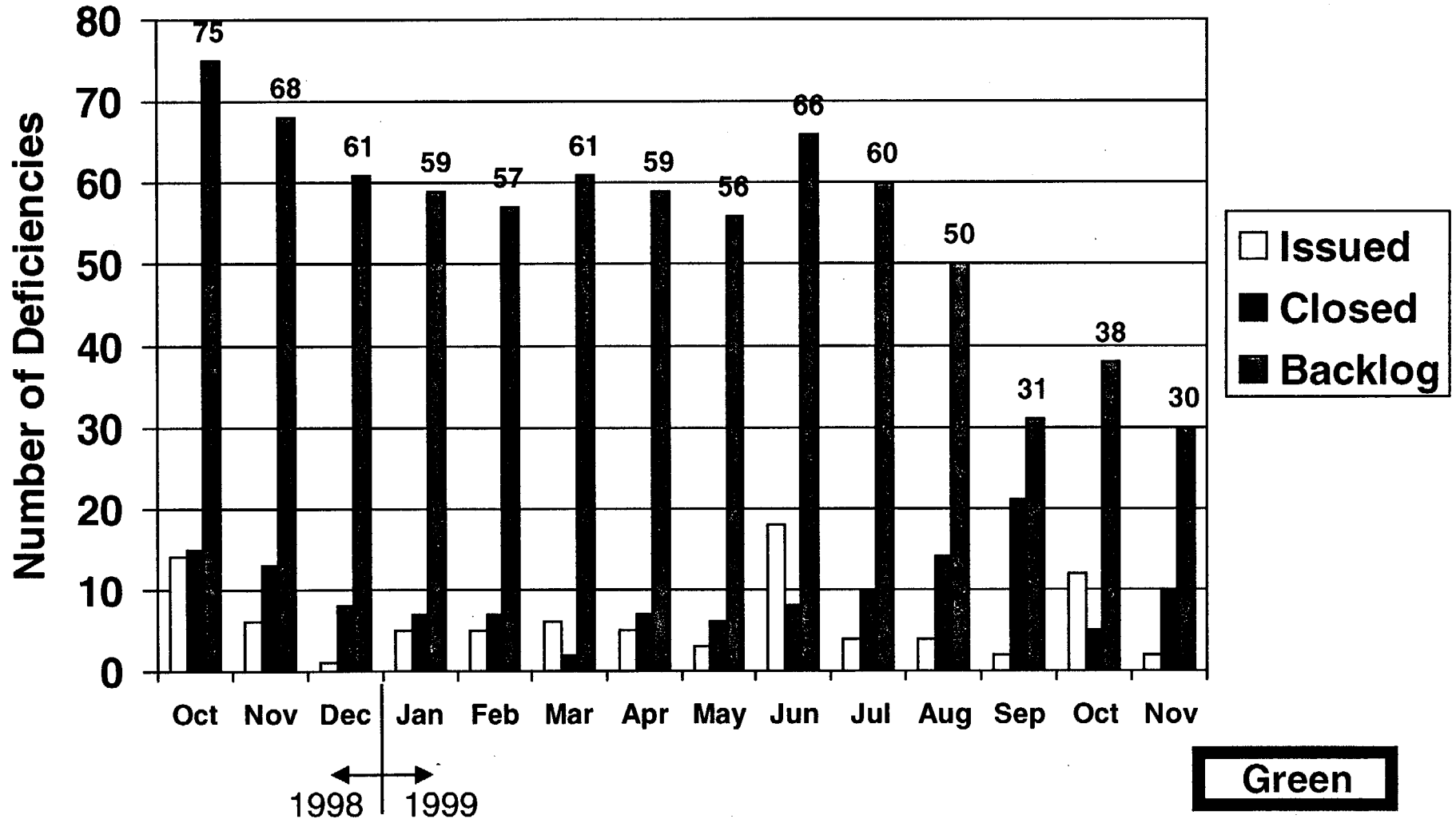

Indicator Manager - Mary Franks

Backlog of M&O Deficiencies (By Age Categories)

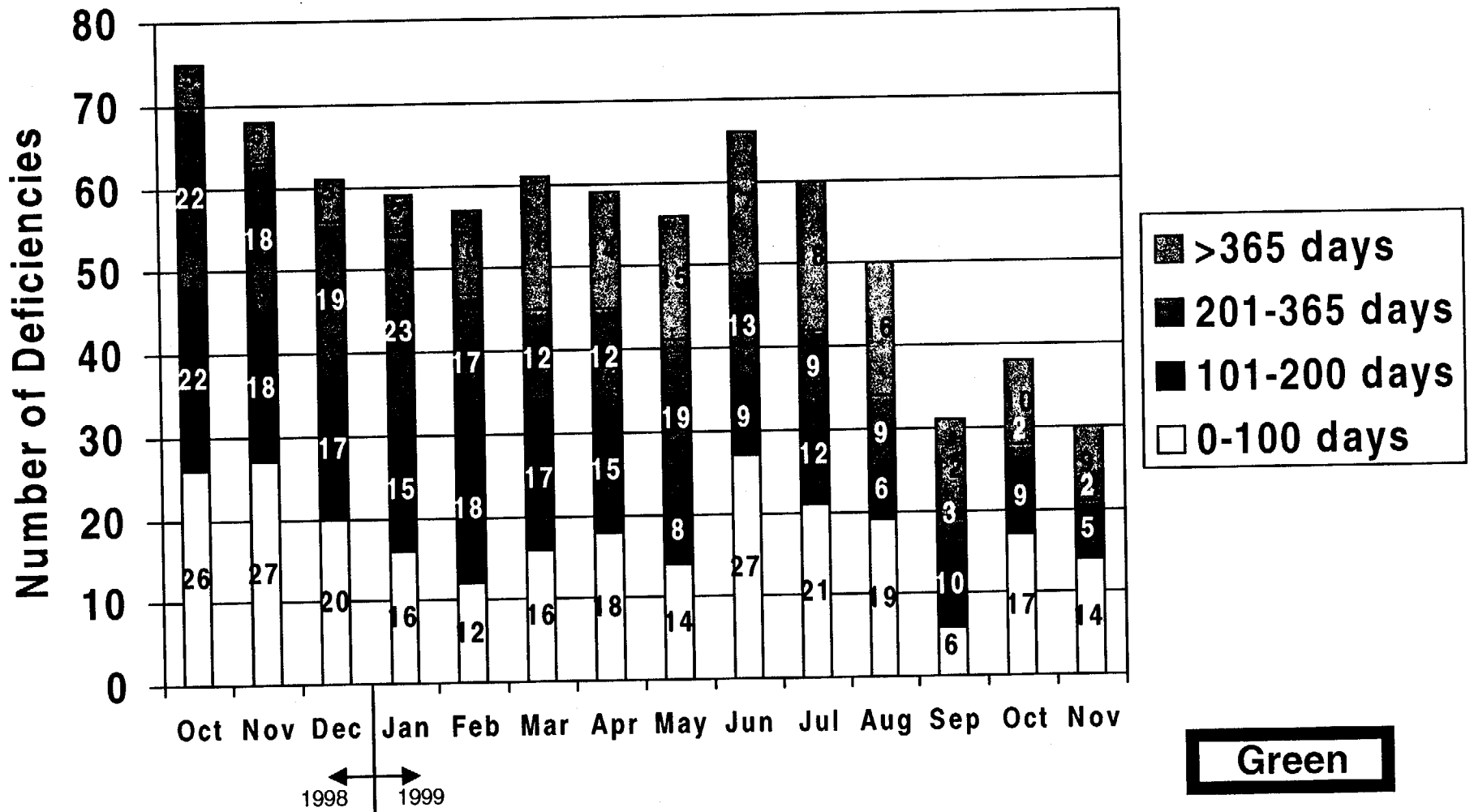

Green

Indicator Manager - Mary Franks

Percent of M&O Deficiencies Identified by Line Organizations

(Six Month Rolling Average)

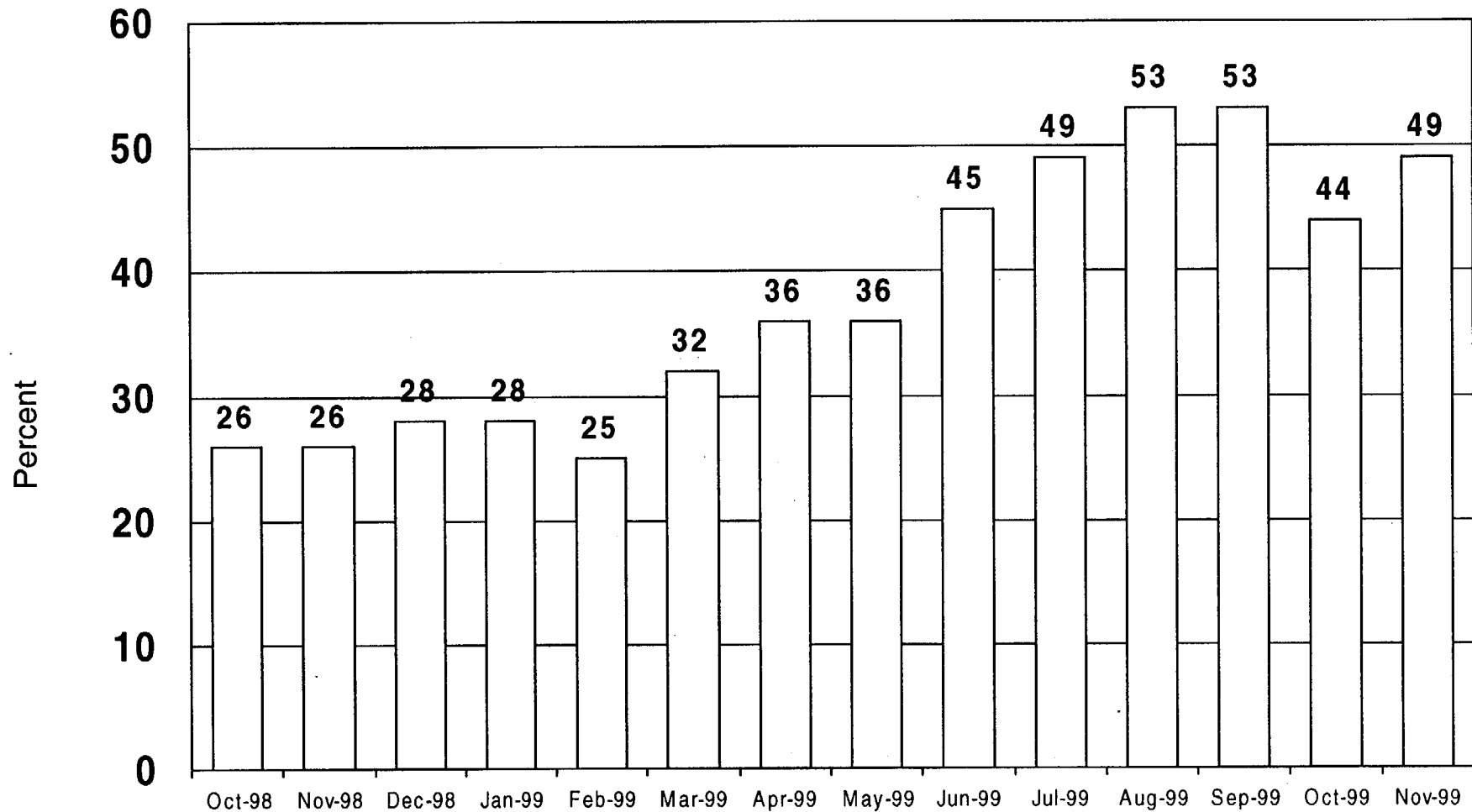

Yellow

Indicator Manager - Mary Franks

M&O Self-Assessments (Monthly Activity)

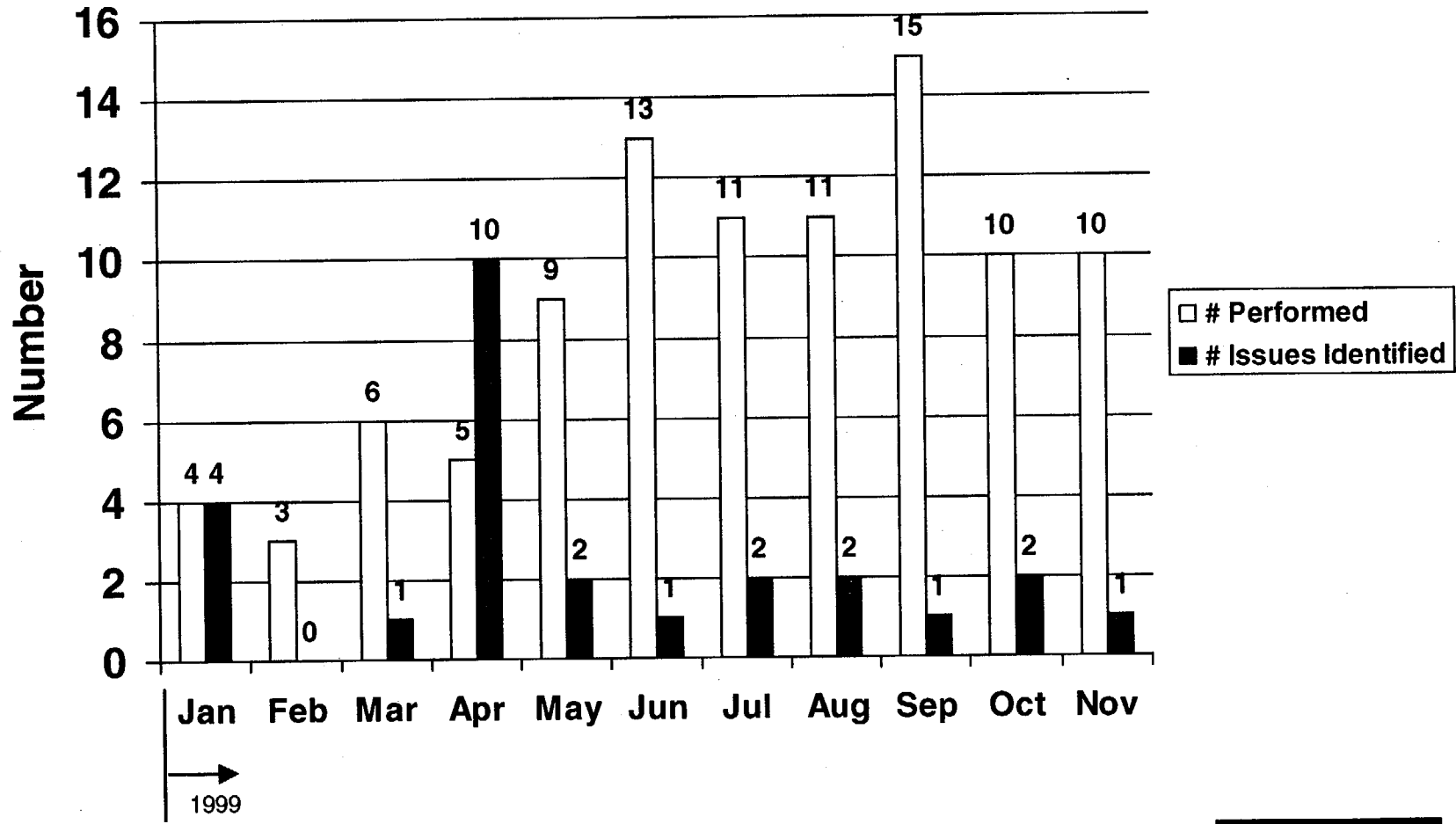

Green

Indicator Manager - Mary Franks

M&O Self-Assessments Quality Issues Backlog

(Monthly Activity for Q-Issues)

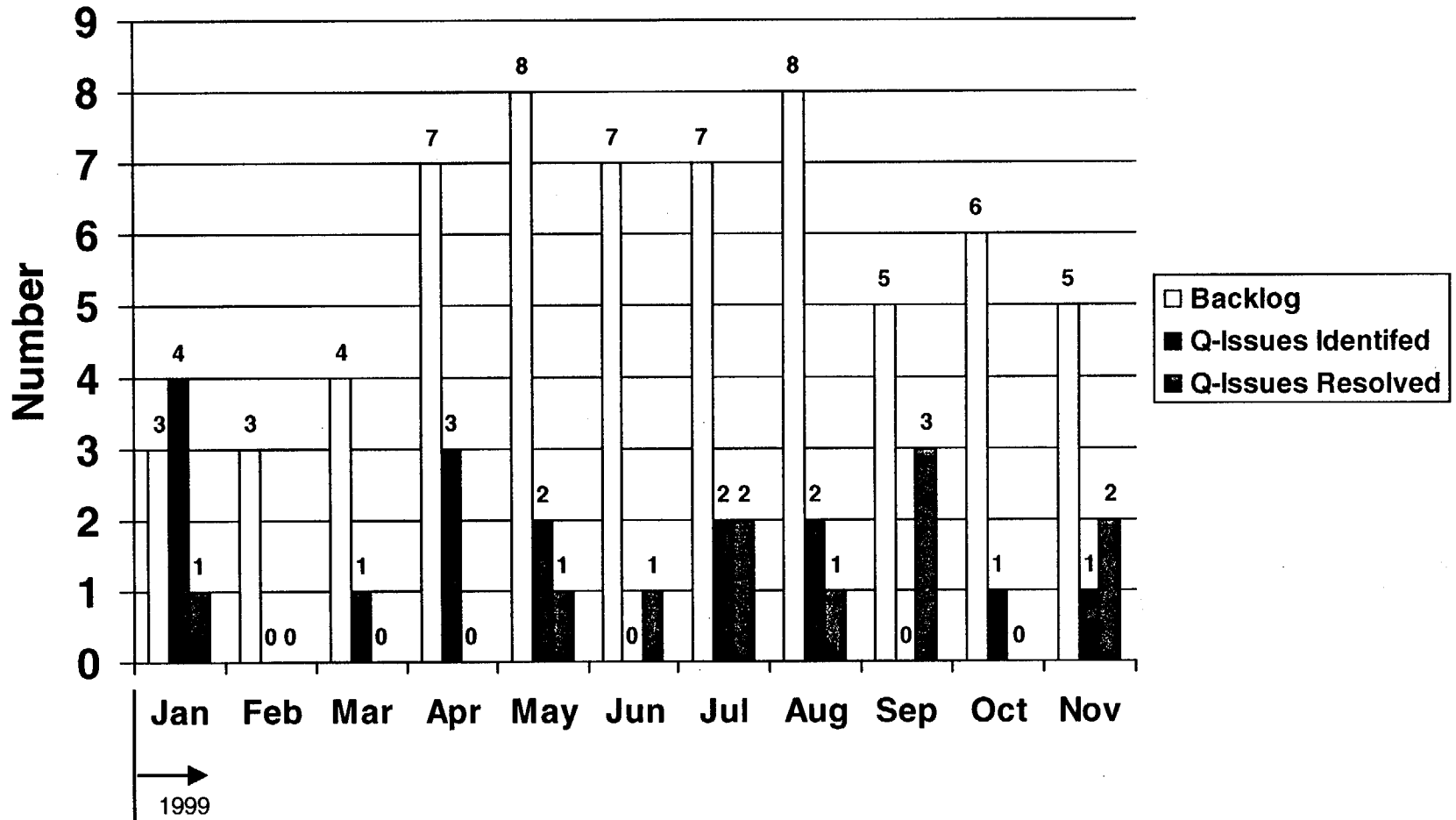

Green

Indicator Manager - Mary Franks

Quality of Technical Documents

(Average Grade of Documents Checked)

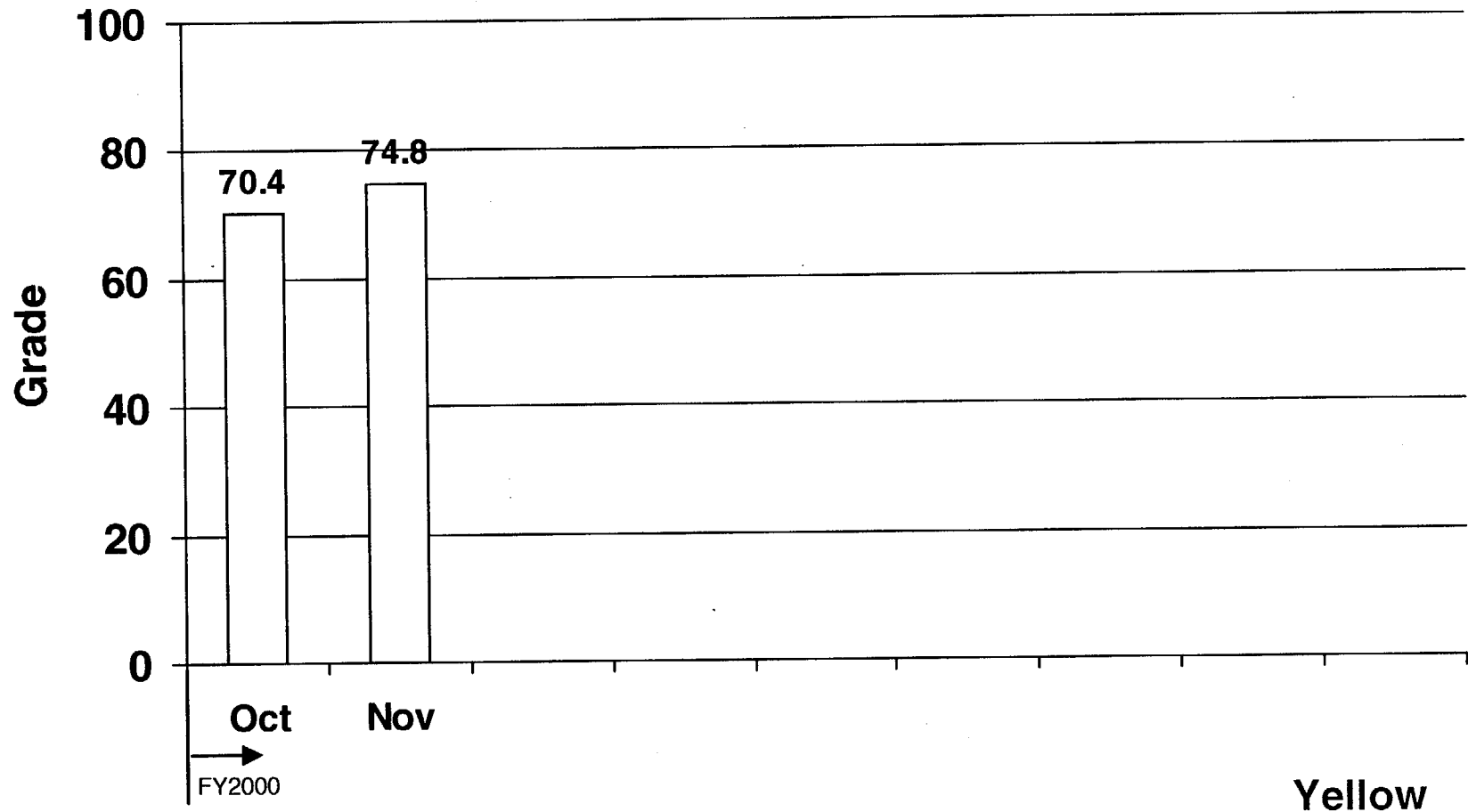

Indicator Managers - John Peters & Mary Franks

Backlog of M&O Deficiencies

(Monthly Activity)

(*Updated through 12/13/99)

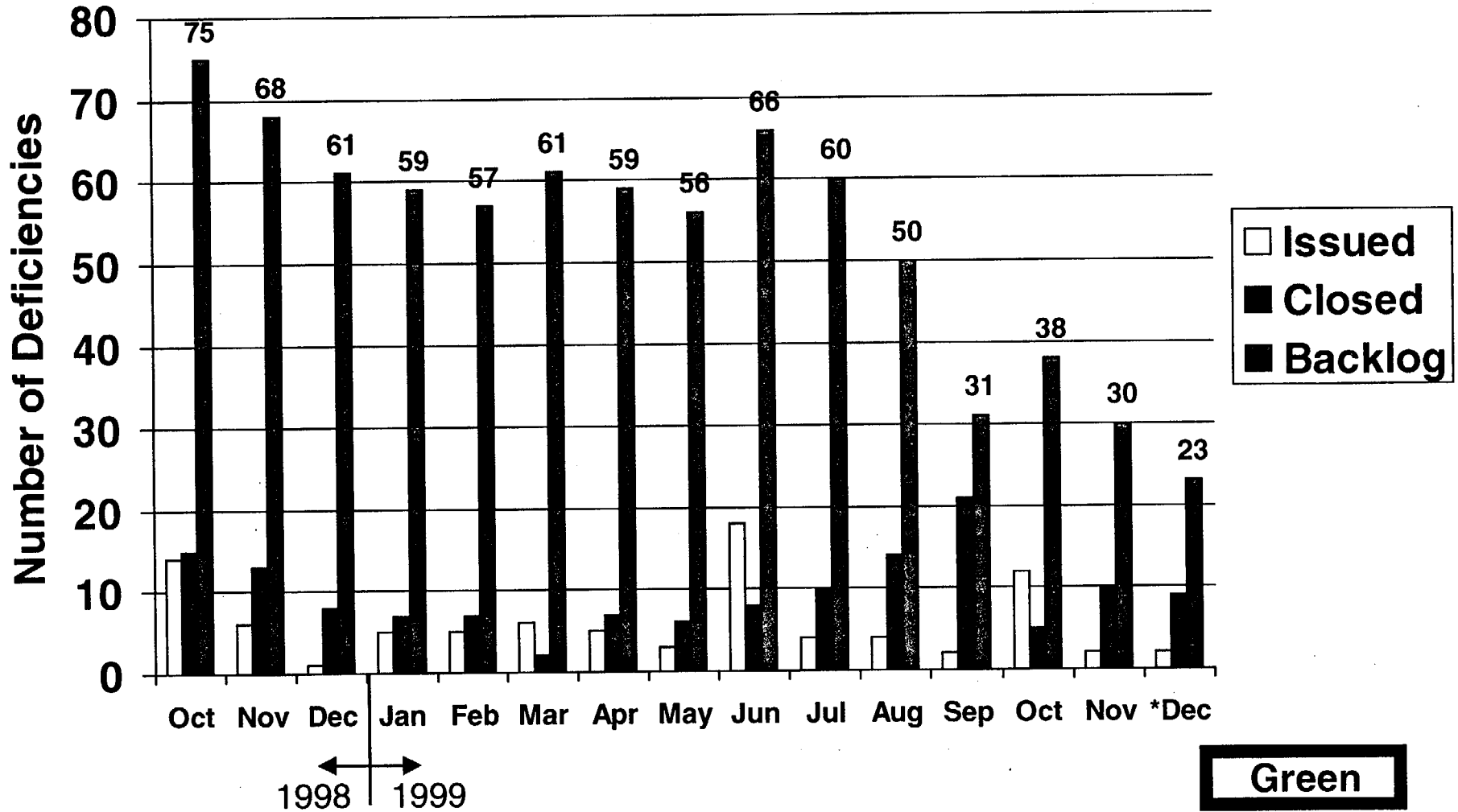

Indicator Manager - Mary Franks

Backlog of M&O Deficiencies (By Age Categories) (*Updated through 12/13/99)

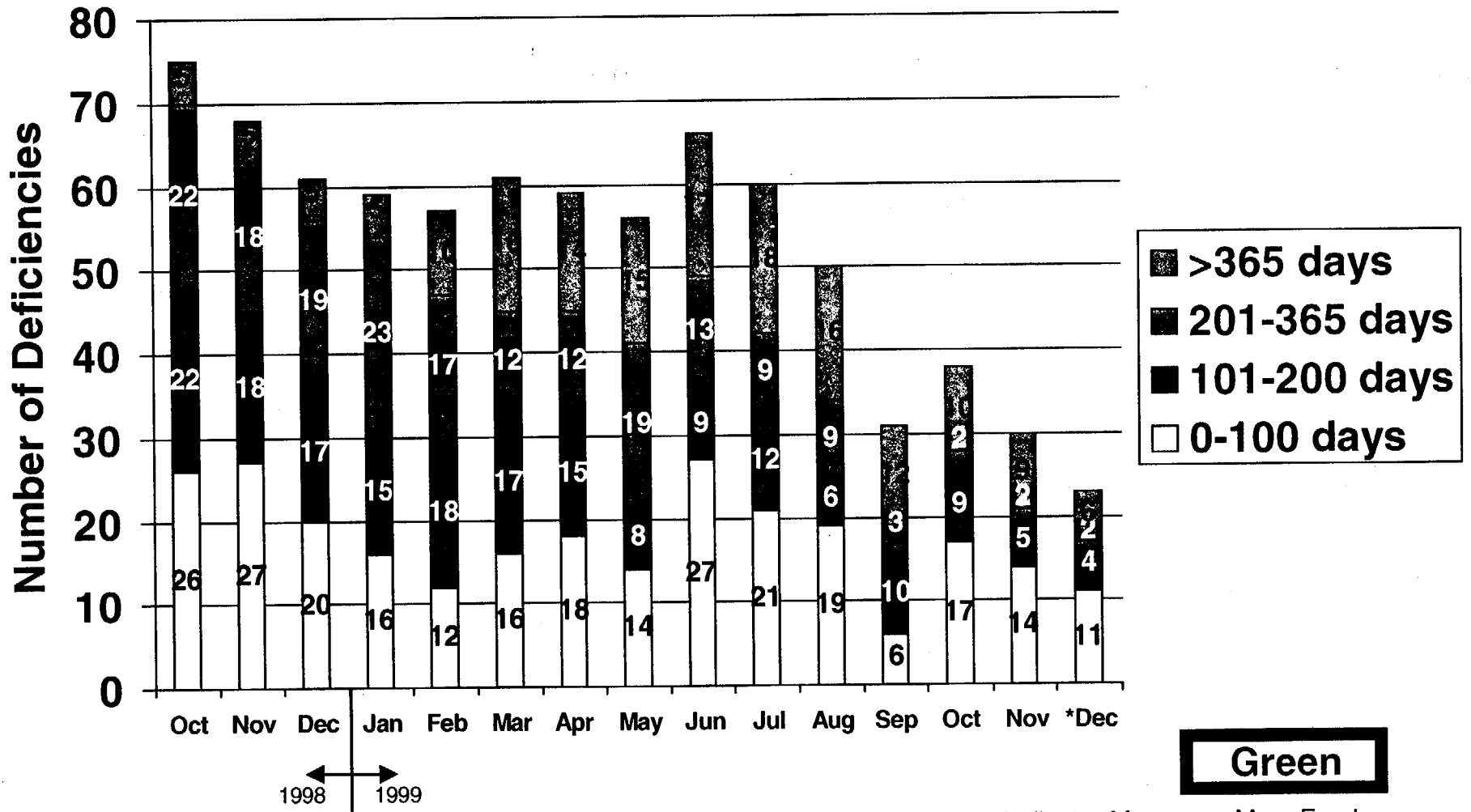

Green

Indicator Manager - Mary Franks

YUCCA MOUNTAIN PROJECT

Yucca Mountain Project Status

- Scientific Notebooks
- Status of Corrective Actions

Presented to:
NRC/DOE Management/Quality Assurance Meeting

Presented by:
Daniel R. Wilkins
Assistant General Manager, M&O

December 16, 1999

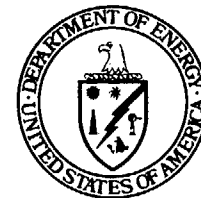

U.S. Department of Energy
Office of Civilian Radioactive
Waste Management

Scientific Notebooks

Status of Scientific Notebook Reviews

- A Scientific Notebook Register was created to track open notebooks
- Reviews of active open notebooks were completed using checklists
 - Closed notebooks will be reviewed as required by “on demand” data verification

Status of Scientific Notebook Reviews

(Continued)

- The M&O conducted training on notebook maintenance at all locations (including the Nevada universities)
- AP-SIII.1Q, *Scientific Notebooks*, was revised to provide improved consistency (effective 6/30/99)

Status of Scientific Notebook Reviews

(Continued)

Organization	Number Reviewed*	NCRs Issued/ Notebooks Involved
LANL	158	0
LBNL	160	0
LLNL	234	33/45
SNL	8	0
USGS	63	5/6
M&O	10	0
UNR/UNLV	<u>23</u>	<u>0</u>
	656	38/51

* No remaining scientific notebooks to be reviewed

Scientific Notebook-Related NCRs

- USGS - Reviews resulted in five NCRs
- Only one NCR (USGS-99-0021) applies to data that may be required in support of AMRs

Scientific Notebook-Related NCRs

(Continued)

- NCR disposition:
 - The Scientific Notebook cannot be reworked to original procedural requirements
 - Appropriate information will be added to the Scientific Notebook so that data sets impacted by NCR are clearly identified
 - Potential for loss of Q status for data sets will be determined after completion of Scientific Notebook repairs
 - Technical Data Management System will be updated as appropriate

Scientific Notebook-Related NCRs

(Continued)

- LLNL - Reviews resulted in 33 NCRs involving 45 notebooks
 - Of the 52 DTNs affected, only 3 were originally identified as needed to support SR/LA (associated with concrete liners)
 - Approved NCR disposition is to mark data as unqualified in the Technical Data Management System
 - Current design does not include concrete liners so data are not needed
 - Data would need to be qualified if used in future

Scientific Notebooks

Summary

- AP-SIII.1Q, *Scientific Notebooks*, establishes single process for scientific notebook development
 - Training is complete
 - Process implemented (6/30/99)
- Active scientific notebooks have been reviewed
- Only one DTN identified as necessary for SR/LA is potentially impacted

Status of Corrective Actions

Overall Status of Major Deficiencies

- Procurement CAR 98-005 was closed by OQA on 9/13/99
- Extensive implementation of new processes for Data Traceability (CAR 99-001), Data Qualification (CAR 98-002), and Model Validation (CAR 98-010)
 - Additional opportunity to demonstrate that corrective actions were effective during January-February audits

Overall Status of Major Deficiencies

(Continued)

- For Software (CAR 98-006), recent audit results show need for reinforcement of requirement for strict procedural compliance when software is used in technical products

Data Traceability (CAR 99-001)

- Consistency in role of author/checker in ensuring traceability and accuracy of data was raised during Oct. 11-15, 1999, audit of Integrated Site Model - Process Model Report
 - Process improvements: Product Checking Group being proceduralized; Checkers directed by Guidelines Manual to use checklist; Completed checklists maintained as records

Data Traceability (CAR 99-001)

(Continued)

- Justification for using/not using specific references receiving increased attention
- Increasing attention to control of inputs from “uncontrolled sources” using appropriate procedure for tracking preliminary inputs

Data Qualification (CAR 98-002)

- Working to ensure consistent implementation of Data Verification Checklists
 - Models for acceptable impact assessments developed and distributed
- Documentation of rationale for using data as corroborative vs. quality inputs being improved
 - Consistent with increased focus on prioritization of data for verification and graded approach to qualification

Model Validation (CAR 98-010)

- New processes are effectively implemented
- Revision 9 to QARD and changes to implementing procedures clarify that model validation equates with confidence building
 - Consistent with recent NUREG on model validation
- Treatment of modeling vs. analyses is receiving attention
 - Distinction is not clear-cut in all cases and will be clarified

Model Validation (CAR 98-010)

(Continued)

- Tracking of model inputs is greatly improved with move to electronic tracking system
 - Move from paper to electronic system after December 1, 1999
 - Checking/reference tracking efficiencies expected

Software (CAR 98-006)

- Controls on software are in place and are being used
 - 89 codes have been confirmed to be qualified
 - 35 codes are being qualified per upgraded procedure
 - Inconsistency in procedural requirements for use of unqualified software has been corrected
 - Approach to documenting testing of macros and subroutines within technical products is being reviewed

Software (CAR 98-006)

(Continued)

- Recent audit identified usage of two codes that had not been placed under Configuration Management
 - This reflects lack of procedural compliance and is being addressed through lessons learned and training

Status of Corrective Actions

Summary

Self-assessments, formal verifications by OQA, and recent performance-based audit results provide evidence that major deficiencies have been corrected

- Technical staffs are successfully implementing new procedures
- New processes are producing high-quality technical products

YUCCA MOUNTAIN PROJECT

Office of Quality Assurance (OQA)

- Results of Process Model Report Audits
- New Supplier Issues

Presented to:

NRC/DOE Management/Quality Assurance Meeting

Presented by:

Bob Clark

Director, Office of Quality Assurance

December 16, 1999



U.S. Department of Energy
Office of Civilian Radioactive
Waste Management

Results Of Process Model Report Audits

- Three OQA Audits performed to date
 - Integrated Site Model
 - Waste Package Degradation
 - Biosphere

Results Of Process Model Report Audits

(Continued)

Integrated Site Model PMR

- Analysis and Model Reports Reviewed:
 - Geologic Framework
 - Rock Properties
 - Mineralogic

- Results:
 - One Deficiency - Software

Results Of Process Model Report Audits

(Continued)

Waste Package Degradation PMR

- Analysis and Model Reports Reviewed:
 - Aging and Phase Stability of Waste Package Outer Barrier
 - General and Localized Corrosion of Waste Package Outer Barrier
 - Environment on the Surfaces of the Drip Shield Waste Package Outer Barrier Surface
 - Analysis and Mechanisms for Early Waste Package Failure
- Results:
 - One Deficiency - Software

Results Of Process Model Report Audits

(Continued)

Biosphere PMR

- Analysis and Model Reports Reviewed:
 - Transfer Coefficient Parameter
 - Dose Conversion Factor
 - Biosphere-Related Features
 - Events and Processes
- Results:
 - Four Deficiencies - areas include:
 - AP-3.10Q, *Analyses and Models* - Checking Process Issues
 - Model Validation Issues
 - AP-3.15Q, *Managing Technical Product Inputs* - Management of Technical Product Inputs Issues

Results Of Process Model Report Audits

(Continued)

CAR Closure Status

- **CAR LVMO-98-C-002 (Data Defensibility)**
 - Remains open pending more thorough OQA review:
 - TBV removal process
 - Completion of the AP-3.15Q checklist. Inconsistent level of justification for some of the AP-3.15Q checklist items
 - Resolution of implementation issues identified during the M&O checklist reviews
- **CAR LVMO-98-C-006 (Software)**
 - Remains open pending new response to resolve recent software deficiencies

Results Of Process Model Report Audits

(Continued)

CAR Closure Status

(Continued)

- **CAR LVMO-98-C-010 (Models)**
 - Remains open pending resolution of Model Validation concerns identified during the Biosphere PMR Audit and OQA verification of the effectiveness of the models process during future PMR audits
- **CAR LVMO-99-C-001 (Data Traceability)**
 - Remains open pending new response to resolve process inconsistencies and implementation issues

Results Of Process Model Report Audits

(Continued)

Summary

- PMR audit teams concluded the M&O is effectively implementing the PVAR processes for the development of PMRs
- Identified deficiencies are not significant, nor do they appear to be widespread
- OQA will further observe and review areas previously noted to determine closure of CARs 98-002 and 98-010
- OQA evaluation of M&O responses to deficiencies identified during the PMR audits will determine further actions necessary for closure of CARs 98-006 and 99-001

New Supplier Issues

- OQA Supplier audits have identified similar deficiencies across several suppliers
 - Pass down of QA/technical requirements to sub-tier vendors is inadequate
- NRC OR questioned the effectiveness of corrective actions related to the recently closed CAR VAMO-98-C-005 and whether or not this is a “trend”

New Supplier Issues

(Continued)

- OQA conducted a surveillance to formally evaluate this concern:
 - Confirmed vendor implementation issues, not M&O procurement issues associated with CAR VAMO-98-C-005
- M&O issued the equivalent of “Lessons Learned” letter to affected suppliers to stress the importance of QA Program implementation

New Supplier Issues

(Continued)

DR or SURVEY	SUPPLIER	STATUS/IMPACT
LLNL-99-D-024	Vaisala	Closed – No impact identified in DR closure documents.
SNL-99-D-025	Geokon	Closed – No impact identified in DR closure documents.
USGS-99-D-048	Setra	Open – No impact on YMP equipment.
LVMO-99-D-050	EG&G	Closed – No impact identified in DR closure documents.
USGS-99-D-080	GE	Open – No impact on YMP services.
USGS-99-D-077	G. B. Tech	Closed – No impact identified in DR closure documents.
LVMO-99-D-081	UFA Ventures	Closed – No impact identified in DR closure documents.
USGS-00-D-013	Eppley	Open – Disposition in process.
OQA-SFE-99-004*	Haynes	No impact, as no YMP POs have been issued to supplier as yet.
OQA-SFE-00-006*	Alpha-Idaho	No impact, as no YMP POs have been issued to supplier as yet.
OQA-SFE-99-003*	Mikron	No impact, as no YMP POs have been issued to supplier as yet.

* Not a deficiency, survey recommendation