

The Role of Organic Complexants and Colloids in the Transport of Radionuclides by Groundwater

Final Report

Pacific Northwest National Laboratory

U.S. Nuclear Regulatory Commission
Office of Nuclear Regulatory Research
Washington, DC 20555-0001



COVER-1

AVAILABILITY NOTICE

Availability of Reference Materials Cited in NRC Publications

NRC publications in the NUREG series, NRC regulations, and Title 10, Energy, of the Code of Federal Regulations, may be purchased from one of the following sources:

1. The Superintendent of Documents
U.S. Government Printing Office
P.O. Box 37082
Washington, DC 20402-9328
<http://www.access.gpo.gov/su_docs>
202-512-1800
2. The National Technical Information Service
Springfield, VA 22161-0002
<<http://www.ntis.gov>>
1-800-553-6847 or locally 703-605-6000

The NUREG series comprises (1) brochures (NUREG/BR-XXXX), (2) proceedings of conferences (NUREG/CP-XXXX), (3) reports resulting from international agreements (NUREG/IA-XXXX), (4) technical and administrative reports and books [(NUREG-XXXX) or (NUREG/CR-XXXX)], and (5) compilations of legal decisions and orders of the Commission and Atomic and Safety Licensing Boards and of Office Directors' decisions under Section 2.206 of NRC's regulations (NUREG-XXXX).

A single copy of each NRC draft report for comment is available free, to the extent of supply, upon written request as follows:

Address: Office of the Chief Information Officer
Reproduction and Distribution
Services Section
U.S. Nuclear Regulatory Commission
Washington, DC 20555-0001

E-mail: <DISTRIBUTION@nrc.gov>

Facsimile: 301-415-2289

A portion of NRC regulatory and technical information is available at NRC's World Wide Web site:

<<http://www.nrc.gov>>

After January 1, 2000, the public may electronically access NUREG-series publications and other NRC records in NRC's Agencywide Document Access and Management System (ADAMS), through the Public Electronic Reading Room (PERR), link <<http://www.nrc.gov/NRC/ADAMS/index.html>>.

Publicly released documents include, to name a few, NUREG-series reports; *Federal Register* notices; applicant, licensee, and vendor documents and correspondence; NRC correspondence and internal memoranda; bulletins and information notices; inspection and investigation reports; licensee event reports; and Commission papers and their attachments.

Documents available from public and special technical libraries include all open literature items, such as books, journal articles, and transactions, *Federal Register* notices, Federal and State legislation, and congressional reports. Such documents as theses, dissertations, foreign reports and translations, and non-NRC conference proceedings may be purchased from their sponsoring organization.

Copies of industry codes and standards used in a substantive manner in the NRC regulatory process are maintained at the NRC Library, Two White Flint North, 11545 Rockville Pike, Rockville, MD 20852-2738. These standards are available in the library for reference use by the public. Codes and standards are usually copyrighted and may be purchased from the originating organization or, if they are American National Standards, from—

American National Standards Institute
11 West 42nd Street
New York, NY 10036-8002
<<http://www.ansi.org>>
212-642-4900

DISCLAIMER

This report was prepared as an account of work sponsored by an agency of the United States Government. Neither the United States Government nor any agency thereof, nor any of their employees, makes any warranty, expressed or implied, or assumes

any legal liability or responsibility for any third party's use, or the results of such use, of any information, apparatus, product, or process disclosed in this report, or represents that its use by such third party would not infringe privately owned rights.

COVER-2

The Role of Organic Complexants and Colloids in the Transport of Radionuclides by Groundwater

Final Report

Manuscript Completed: April 1999
Date Published: January 2000

Prepared by

D. E. Robertson, C. W. Thomas, S. L. Pratt^a
K. H. Abel, E. A. Lepel, A. J. Schilk^a
E. L. Cooper, F. Caron, K. J. King, R. W. D. Killey, P. G. Hartwig^b
J. F. Mattie, M. K. Haas, E. Romaniszyn, M. Benz, W. G. Evenden^b
S. O. Link^c
P. Vilks^d

^aPacific Northwest National Laboratory
Richland, WA 99352

Subcontractors:

^bChalk River Laboratories
Chalk River, Ontario, Canada KOJ1O

^cWashington State University at Tri-Cities
Richland, WA 99352

^dWhiteshell Laboratories
Whiteshell, Manitoba, Canada

E. O'Donnell, NRC Project Manager

Prepared for
Division of Risk Analysis and Applications
Office of Nuclear Regulatory Research
U.S. Nuclear Regulatory Commission
Washington, DC 20555-0001
NRC Job Code L1935



File

Disclaimer

NUREG/CR-6627 is not a substitute for NRC regulations and compliance is not required. The approaches and/or methods described in this NUREG/CR are provided for information only. Publication of this report does not necessarily constitute NRC approval or agreement with the information contained herein.

Abstract

This final report for project JCN L1935, "Role of Organic Complexation and Colloids in the Transport of Radionuclides by Groundwater", describes the results of field and laboratory work conducted during the last two years of the project. It also contains summaries of important observations reported in earlier progress reports NUREG/CR-6429 and NUREG/CR-6587, and other open literature publications.

The field studies were conducted at two low-level radioactive waste (LLW) management areas within the boundaries of the Chalk River Laboratories, Chalk River, Ontario, Canada, under a cooperative arrangement with the Atomic Energy of Canada, Ltd. At these locations, several well-defined, slightly radioactive groundwater contaminant plumes have developed over the past 25 to 40 years, providing excellent field sites for conducting studies of radionuclide transport by groundwater. This work was conducted to provide NRC, licensees, and other interested parties with information to better understand and predict the groundwater transport of radionuclides from LLW disposal facilities.

These studies have primarily addressed: 1) characterization of the sub-surface geochemical environment near the disposal facilities, 2) identification and quantification of the migrating radionuclides and their chemical speciation in groundwater, 3) the sorption behavior (Kd measurements) of the mobile radionuclide species (cationic and anionic) onto site soils, 4) identification of colloidal radionuclides, and 5) the environmental dynamics of ^{14}C in the vicinity of a solid LLW disposal facility (published earlier as NUREG/CR-6587).

The results of these studies indicate that the mobile radionuclides in groundwater at the Chalk River LLW disposal sites are primarily in solution as dissolved anionic organo-radionuclide complexes. These complexes appear to be quite stable over long time periods in the groundwater

environment. Ion chromatographic separations of the soluble anionic radionuclide species from both ultra-filtered and 0.45 μm filtered groundwater from the Chemical Pit contaminant plume have demonstrated the presence of multiple chemical species for each radionuclide that are anionic in nature and consist of organo-radionuclide species. There is some colloidal transport, but it is minor compared to the dissolved radionuclide species.

Soil Kd measurements using the natural anionic species as radio-tracers gave much lower Kd values compared to measurements made using commercially available uncomplexed radio-tracers. These experiments confirm that the natural anionic organo-radionuclide species in groundwater are much more mobile than would be predicted from transport modeling using classical literature Kd data bases.

Carbon-14 migrating in groundwater from the Area-C LLW disposal site emerges in a wetland area 300 m downgradient from the waste trenches and enters the ambient vegetation. Several field studies showed that the ^{14}C almost exclusively enters the vegetation by photosynthetic uptake of $^{14}\text{CO}_2$ released from the ground surface, while transpiration uptake directly from the contaminated groundwater is essentially negligible.

These studies will provide performance assessment modelers and regulators with additional information to better assess the rates and mechanisms of radionuclide transport from LLW disposal facilities that become infiltrated with water.

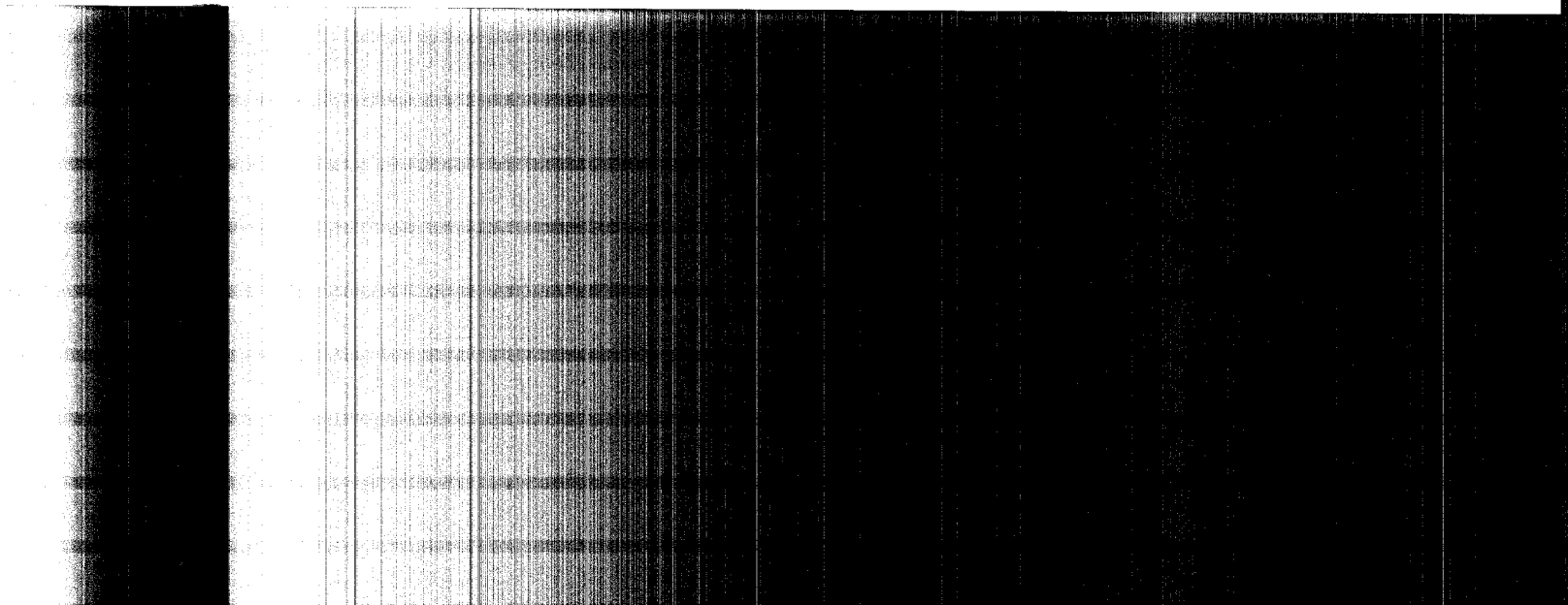

Contents

Abstract.....		iii
Figures.....		vii
Tables.....		ix
Executive Summary.....		xi
Foreword.....		xv
Acknowledgements.....		xix
1 Introduction.....		1
1.1 Background Information.....		2
1.2 Description of Experimental Study Sites at CRL.....		3
1.2.1 Chemical Pit Liquid Waste Disposal Site.....		9
1.2.2 Area C Solid Waste Disposal Site.....		14
1.2.3 Previous Related Chemical and Radiological Characterization.....		20
2 Experimental.....		23
2.1 Observation Wells.....		23
2.2 Groundwater Sampling and Analyses.....		23
2.2.1 Sampling.....		23
2.2.2 Radiometric Analyses.....		24
2.3 Ultra-filtration Experiments.....		24
2.3.1 Colloid Sampling and Analysis.....		24
2.3.2 Anion Exchange Chromatography of Ultra-filtered Groundwater.....		25
2.4 Laboratory Chromatography Experiments.....		28
2.4.1 Field Sampling.....		28
2.4.2 Chromatographic Equipment.....		28
2.4.3 Preparation of AG MP-1 Columns.....		30
2.4.4 Procedure for Loading and Eluting AG MP-1 Columns.....		30
2.4.5 Radionuclide Analysis.....		30
2.4.6 Measurement of UV Spectra.....		30
2.5 Laboratory Kd Experiments with Anionic and Cationic Radionuclide Species.....		30
2.5.1 Soil and Groundwater Sampling and Preparation for Kd Measurements.....		31
2.5.2 Isolation of Anionic and Cationic Radionuclide Fractions from Contaminated Groundwater.....		32
2.5.3 Blanks, "Conventional Batch" Kd Measurements, and "Reverse Osmosis" Samples.....		32
2.5.4 Speciation Checks for Soluble Radionuclides.....		33
2.5.5 Analysis of Soluble Groundwater Constituents.....		37
2.5.6 Addition of Spikes for Kd Measurements.....		37
3 Results and Discussion.....		40
3.1 Concentrations and Chemical Speciation in Groundwater.....		40
3.2 Radionuclide Association with Colloids in Groundwater.....		46
3.2.1 Evolution of Colloid Speciation Along the Flowline.....		46
3.2.2 Evolution of Chemical Speciation Along the Flowline.....		50
3.3 Speciation of Radionuclides and Organics in Groundwater.....		61
3.4 Adsorption of Anionic and Cationic Radionuclide Species onto Soil.....		67
3.4.1 Groundwater Characterization.....		67
3.4.2 Kd Measurements Using Cationic and Anionic Radionuclide Species.....		75
3.4.3 Speciation Checks During Kd Measurements.....		80
4 Summary and Conclusions.....		87
5 References.....		89

6	Appendices	93
	Appendix 1. Instructions for Preparation of Chromatographic Columns, 96-02	93
	Appendix 2. Procedure for Chromatographic Separation, 96-05	94

Figures

1.1	Chalk River Laboratories site location map	5
1.2	Liquid Dispersal Area and Waste Management Area A.....	6
1.3	Borehole and cross section locations in the vicinity of the Chemical Pit.....	7
1.4	Stratigraphic section through the Chemical Pit and East Swamp	8
1.5	Water table contours in the vicinity of the Chemical Pit.....	11
1.6	Annual average concentrations of total beta-gamma activity and ⁹⁰ Sr at the East Swamp Stream weir (1965-1993).....	12
1.7	Annual average concentrations of ⁶⁰ Co and ¹⁰⁶ Ru at the East Swamp Stream weir (1974-1993).....	13
1.8	Borehole and cross-section locations in the vicinity of Waste Management Area C.....	16
1.9	Stratigraphic section through Area C and the Duke Swamp groundwater discharge area.....	17
1.10	Surface hydrology, water table contours, and areal extent of groundwater contamination by ³ H (bifurcating, medium-gray pattern) in the vicinity of Area C.....	18
1.11	Annual fluxes of ³ H and ⁶⁰ Co through the Duke Stream weir	19
2.1	Water Filtration Scheme	26
2.2	Chromatography equipment.....	29
2.3	Simplified flowchart of sample manipulation and analysis.....	34
2.4	Flowchart showing the procedure for blanks (with uncontaminated groundwater) and for speciation checks	36
3.1	Cobalt-60 concentrations and chemical forms at sampling well ES-16 at the CRL Chemical Pit groundwater plume	41
3.2	Ruthenium-106 concentrations and chemical forms at sampling well ES-16 at the CRL Chemical Pit groundwater plume.....	42
3.3	Antimony-125 concentrations and chemical forms at sampling well ES-16 at the CRL Chemical Pit groundwater plume.....	43
3.4	Plutonium-239/240 concentrations and chemical forms in groundwater at well ES -16 at the CRL Chemical Pit groundwater plume.....	44
3.5	Cobalt-60 concentrations and chemical forms in the CRL Chemical Pit groundwater plume as a function of distance from the pit	45
3.6	Cobalt-60 chromatograms for samples from the three wells.....	52
3.7	Ruthenium-106 chromatograms for samples from the three wells.....	53
3.8	Uranium-238 chromatograms for the samples from the three wells	54
3.9	Neptunium-237 chromatograms for the samples from the three wells	55
3.10	Neptunium-237 chromatograms for samples from the three wells.....	56
3.11	Plutonium-239+240 chromatograms for samples from the three wells.....	57
3.12	Plutonium-239+240 chromatograms for samples from the three wells.....	58
3.13	Americium-241 chromatograms for samples from the three wells	59
3.14	Curium-244 chromatograms for samples from the three wells.....	60
3.15	Cobalt-60 chromatogram for ES16 1996 April 22 sample	63
3.16	Cobalt-60 chromatogram for ES16 1993 August 17 sample.....	64
3.17	UV absorbance chromatogram for ES16 April 22 1996 sample	65
3.18	UV absorbance chromatogram for ES9 May 27 1996 sample.....	66
3.19	UV absorbance chromatograms for successive runs	69
3.20	UV absorbance chromatograms for successive runs (continued)	70
3.21	Cobalt-60 chromatograms for successive runs	71
3.22	Cs-137 and Co-60 chromatograms for well ES16 1996 May 5 sample.....	72
3.23	Speciation of nuclides and tracers in contaminated groundwater (from well ES16) Before and after pretreatment through a cation exchange resin.....	74

3.24	Speciation of nuclides and tracers in contaminated groundwater (from well ES-16) Before and after pre-treatment through a anion exchange resin column. The ⁵⁷ Co, ⁹⁴ Nb, and ¹³⁴ Cs were the commercial tracers.....	82
3.25	Nuclide speciation (tracers only) in the samples for the conventional "batch" Kd determinations before and after equilibration with CRL sand. Note: "Am-241-g" refers to the results obtained with gamma spectrometry, and "Am-241-a" were obtained with alpha spectrometry.....	83
3.26	Nuclide speciation (tracers only) in the samples for "batch" conventional Kd determinations, after nanofiltration of the uncontaminated groundwater to remove organics and colloidal particles.....	84
3.27	Nuclide speciation stability in aqueous solutions during the experiment (ES-16 with tracers)	85
3.28	Nuclide speciation stability on aqueous solutions during the experiment (ES16 uncontaminated groundwater, with tracers).....	86

Tables

1.1	Major ion chemistry in groundwater from the Chemical Pit vicinity	15
1.2	Major ion chemistry in groundwater from the Area C vicinity	21
1.3	Anthropogenic organics from the Area C groundwater plume in units of $\mu\text{g/L}$	22
1.4	Carbon and ^{14}C concentrations in Area C waters.....	22
2.1	Experimental Conditions for AG MP-1 separations.....	27
2.2	Levels of radionuclides present in contaminated and uncontaminated groundwaters (measured), and levels of artificial tracers added to each solution (calculated).....	35
2.3	Concentration of major ions in ES-16 contaminated groundwater at various stages of sample processing	38
2.4	Concentrations of major ions in ES-9 uncontaminated groundwater at various stages of sample processing	39
3.1	Gravimetric particle size analysis.....	47
3.2	Size fractionation of gamma-emitters.....	48
3.3	Size fractionation of actinides	49
3.4	Summary of counts in the peaks of chromatograms from ultra-filtered samples.....	51
3.5	Levels of radionuclides present in contaminated and uncontaminated groundwaters (measured), and levels of artificial tracers added to each solution (calculated)	73
3.6	Concentrations of major ions in ES-16 contaminated groundwater at various stages of sample processing	77
3.7	Concentrations of major ions in ES-9 uncontaminated groundwater at various stages of sample processing	78
3.8	K_d values obtained for the ambient radionuclides and the tracers for the different sample manipulations	79
3.9	Comparison of values obtained in this work with ES-16 groundwater (pre-treated with cation exchange resin to isolate the anionic species) and with artificial tracers vs other works.....	80

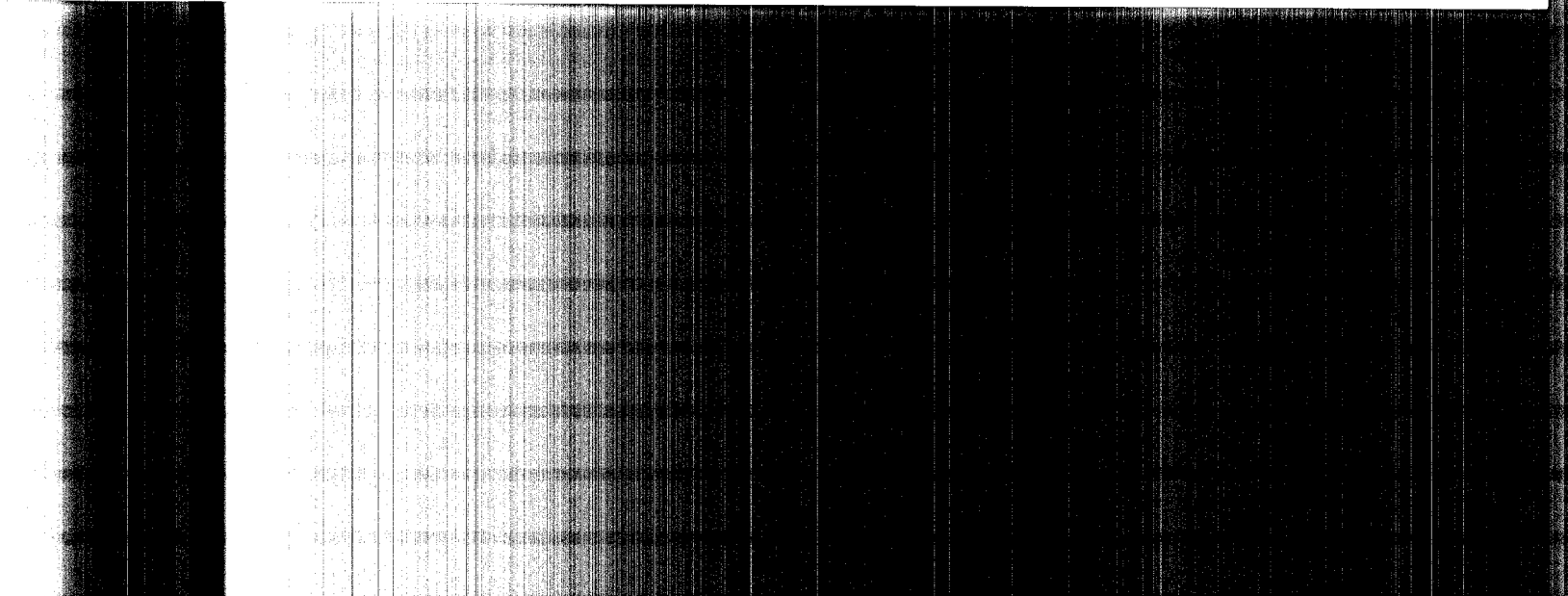

Executive Summary

This final report describes the results of radiological and geochemical investigations of the mechanisms of radionuclide transport in groundwater at two low-level waste (LLW) disposal sites within the Chalk River Laboratories (CRL), Ontario, Canada. These sites, the Chemical Pit liquid dispersal facility and the Waste Management Area C solid LLW disposal site, have provided valuable 30- to 40-year old field locations for characterizing the migration of radionuclides and evaluating a number of recent site performance objectives for LLW disposal facilities. This information will aid the NRC and other federal, state, and local regulators, as well as LLW disposal site developers and waste generators, in maximizing the effectiveness of existing or projected LLW disposal facilities for isolating radionuclides from the general public and thereby improving the health and safety aspects of LLW disposal.

These studies have focused on identifying the physico-chemical species of mobile radionuclides in groundwater at the field sites and characterizing their behavior in the subsurface environment. Following the identification and characterization of the mobile radionuclide species, these soluble anionic chemical forms were isolated from contaminated groundwater and used as tracers for conducting Kd measurements on site soils. These special Kd measurements can then be used to provide more realistic estimates of the transport rates of the mobile radionuclide species in groundwater. In addition, the role of colloids in transporting radionuclides in groundwater has been investigated at this field site.

Field and laboratory studies, using large-volume groundwater sampling techniques to concentrate and separate the soluble charge-forms of the radionuclides, have shown that a number of mobile radionuclide species, including ^{55}Fe , ^{60}Co , ^{106}Ru , ^{125}Sb , and $^{239,240}\text{Pu}$, are generally anionic in nature. Supportive evidence suggests that the radionuclides are being sequestered by naturally occurring and/or man-made complexing materials, including fulvic and humic substances. These

complexed organo-radionuclide species appear to be quite stable in the groundwater over time. Once formed, these species change very little in their physicochemical properties during transport in the groundwater.

Ion chromatographic separations of the mobile radionuclides and dissolved organic constituents concentrated from contaminated groundwater onto anion exchange resin were conducted to further characterize these organo-radionuclide species. These separations have identified multiple individual chemical species of ^{60}Co , ^{106}Ru , and $^{239,240}\text{Pu}$, indicating the presence of a complex mixture of these sequestered radionuclides being transported in the groundwater. Chromatograms for ^{60}Co from samples collected in 1993 and 1996 showed that the concentrations declined and the chemical speciation slightly changed since use of the pit was discontinued. Chromatograms of soluble organic constituents in the groundwater were produced from measurements of UV absorbance at 254 nm with a UV detector. Speciation of organics in samples collected inside and outside the plume showed many similarities both in the shapes of the chromatograms and in the UV absorbance spectra of separated fractions. This indicated that many of the organic species in the plume were natural in origin. Repeated separations from portions of the same sample showed that the technique gave very consistent results and could be used to measure small changes in chemical speciation. Several soluble anionic species of ^{137}Cs were also observed, which confirms that organic complexation is also sequestering some of the ^{137}Cs . These results have provided a better understanding of the chemical nature and behavior of radionuclides and organics in groundwater and their interactions within the contaminant plume. These studies have shown, through the use of multiple state-of-the-art characterization methodologies, the consistent relationship between migrating radionuclides and naturally occurring humic and fulvic

substances in CRL groundwater. The ubiquitous presence of humic and fulvic materials in sampled waters, their substantial capacity for complexation of cationic radionuclides under the existing geochemical conditions, and their general lack of attraction for most mineral surfaces in the aquifer medium suggest that these organic species were primarily responsible for the facilitated transport of radionuclides at this location. As the CRL site serves as a viable model for LLW disposal sites in humid environments, the results of this investigation have far-reaching implications in the fields of facility design, maintenance, and remediation.

The evolution of the physico-chemical speciation of radionuclides in a contaminant plume was studied by sampling three wells on a flowline from the Chemical Pit disposal site to a nearby wetland. Ultra-filtration was used to separate the samples into fractions: >450 nm, 10 to 450 nm, 1 to 10 nm and <1 nm nominal sizes. The results showed that the radionuclide species were predominantly in the < 1 nm size range and could be classified as "soluble" species. This was likely due to organic complexation, since previous studies showed much evidence of complexed species in the plume.

However, small but significant quantities of radionuclides were associated with colloidal sized particles in the 1-10 nm and the 10-450 nm size ranges. This suggests that colloidal transport of radionuclides in this groundwater system could be occurring to a small but measurable degree. Colloidal transport is, nevertheless, small compared to the transport of soluble complexed organo-radionuclide species.

The "soluble" species in the < 1 nm fraction were further studied by pre-concentrating them on AG MP-1 anion exchange resin and then chromatographically separating them by eluting with various concentration gradients of KCl and HCl. The chromatograms for ^{60}Co , ^{106}Ru , and actinides separated from the three samples showed small changes in the intensities of peaks with distance from the pit. These changes indicated that the chemical speciation was slightly evolving as the radionuclides move through the plume.

Radionuclides present in contaminated aquifers have varying degrees of interaction with geological material, which can be determined experimentally using a standard liquid-solid partition coefficient (K_d). This coefficient is an empirical parameter that lumps together several surface-driven processes at the surface of the solids, as well as differences in aqueous speciation of the radionuclides.

Previous studies at the Chalk River Laboratories (CRL) have revealed that some radionuclides in contaminated groundwater are much more mobile than expected, based on predictions using K_d values from laboratory batch measurements. This increased mobility was linked to the presence of stable anionic species of the radionuclides which have a relatively low affinity for sorbing to soil. In the current work, aqueous species of the radionuclides present in the contaminated aquifer (^{60}Co , ^{106}Ru , ^{137}Cs , ^{238}Pu , $^{239/240}\text{Pu}$, ^{241}Am and ^{244}Cm), were isolated in their anionic and cationic forms to separately determine the K_d 's for these two groups of charge-forms. These results were compared with batch K_d 's measured after spiking groundwater with different radioisotopes of the same elements that had no prior opportunity to form complexes.

Batch K_d values obtained with isolated anionic forms of ^{60}Co , ^{137}Cs , Pu isotopes and ^{241}Am found in the aquifer, were lower by one to two orders of magnitude compared to the K_d values of ^{57}Co , ^{134}Cs , $^{239/240}\text{Pu}$ and ^{241}Am , added as tracers in laboratory short-term conventional measurements. These K_d values, measured by using the actual anionic radionuclide species that have exhibited enhanced mobility in groundwater, will allow transport modelers to make more accurate predictions of the "first arrival" times of radionuclides migrating from LLW facilities.

With the exception of Ru, all of the radioelements considered here would be expected to occur as cationic species in the aquifer. Mixes of negative and positive species of the aquifer radionuclides were shown to be stable over the duration of the

experiment, whereas the added tracers remained predominantly positively charged, except for ^{94}Nb . This confirmed that the aqueous speciation observed during these experiments was as close as possible to the *in situ* conditions, and had a strong and apparently lasting influence on sorption.

A special study of the dynamics of ^{14}C in the Duke Swamp wetland area near the Area-C solid LLW disposal site was conducted during this investigation. This study has recently been published as a separate report (NUREG/CR-6587), but a summary of the important observations are given here.

An understanding of the pathways for transfer of $^{14}\text{CO}_2$ from low-level radioactive waste management sites to the environment is needed for risk assessment analyses. At the Chalk River Laboratories (CRL), Atomic Energy of Canada (AECL), ^{14}C is being released from a LLW management area and it is being transported in groundwater to a wetlands discharge area some 300 meters from the waste trenches. This area provides the opportunity to quantify the distribution and movement of ^{14}C in the environment. Observations of ^{14}C in ground water, surface water, air, plants and peat were made. In addition, it was possible to determine the major pathway for ^{14}C uptake by vegetation growing at this site, i.e., photosynthetic uptake through the leaf system versus transpirational uptake through the root system.

Concentrations of ^{14}C in the groundwater between the LLW disposal facility and Duke Swamp remained constant until discharge into the swamp surface. Carbon-14 dissipated very quickly at the surface, with 270,000 pCi g^{-1} carbon in the groundwater changing to 1890 pCi g^{-1} at the first ground-level passive air sampler. Surface waters leaving the swamp had no enhanced ^{14}C specific activity.

An experimental study area (approximately 10m x 10m square) located around the highest concentrations of ^{14}C observed in vegetation growing in Duke Swamp was fenced, and studies of the environmental dynamics of the ^{14}C were

conducted within this fenced area. Air samplers placed within this experimental site near the contaminant plume discharge point in Duke Swamp, showed little change in ^{14}C specific activity with horizontal distance or time within the 270 m^2 fenced area. At a height of 6 meters, the ^{14}C specific activity was 297 pCi g^{-1} which was a decrease of approximately 6-fold from concentrations on the ground.

A vegetation survey within the fence showed little heterogeneity with distance. The ^{14}C specific activity was significantly greater in the moss and grass than in forbs, ferns, or fir. The moss and grass samples had greater specific activity because they were collected closer to the ground than the forbs, ferns and fir. There was an exponential decrease in ^{14}C specific activity in vegetation with height. Cedar leaves collected at the same heights as the lichens showed ^{14}C specific activity similar to the lichens.

The specific activity in peat was 1890 pCi g^{-1} C near the surface, dropping to background levels at a depth of 5.5 cm. Using 30 years as the exposure time in the ecosystem, it was estimated that the peat accumulation rate was 1.8 mm yr^{-1} .

The significance of the transpirational pathway for transport of ^{14}C in groundwater through roots to the shoots was tested in two ways. The first method compared the ratio of specific activity of lichens to specific activity of vascular plants in two sites, one without ^{14}C in the groundwater and one with ^{14}C in the groundwater. The specific activity ratios were the same. The second method compared the specific activity in shoots of vascular plants transplanted into the experimental area with ^{14}C in the ground water. Pairs of each species were either bagged or left open (for root uptake). For the time period of the experiment, no increase in ^{14}C was noted in the plants that were left open compared with the plants with the bagged root systems. By these tests, it was concluded that there was no significant uptake of $^{14}\text{CO}_2$ in the

transpirational stream within the limits of the measured precision.

Carbon-14 concentration ratios for air to vegetation ranged from 1.6 to 5.9. These values, being greater than one, suggest significant gradients in air and vegetation levels near the ground. Because there was no

transport of ^{14}C from groundwater directly into vegetation, the concentration ratio from groundwater-to-vegetation must be close to zero. Background levels of ^{14}C were found in the peat below 5.5 cm and it could be assumed that the concentration ratio from groundwater-to-peat was close to zero.

Foreword

Any candidate site intended for use as a facility for the shallow burial of low-level radioactive waste must satisfy the requirements of 10 CFR 61 (Licensing Requirements for Land Disposal of Radioactive Waste), subpart D, section 61.5(2). This regulation states that any proposed site must be capable of being characterized, modeled, analyzed, and monitored. When such facilities are licensed, the primary concern is the means (natural and/or enhanced) by which radionuclides migrate beyond site boundaries. A thorough understanding of these means could lead to the prevention or minimization of such transport, thereby sparing the general public from undue exposure. Furthermore, shallow land burial has been routinely used for the disposal of low-level radioactive wastes during which imperfect disposal practices, precipitation infiltration, and groundwater leaching of various waste forms have led to the contamination of many surface and subsurface waters (Riley and Zachara 1992). Despite current waste-management programs, which are intended to modify and/or reduce waste streams and to contain pollutants from past disposals, the active migration of radionuclides from many of the aforementioned sites is an almost ubiquitous phenomenon (e.g., McCarthy 1988; Olsen et al. 1986; and references therein). Whether one is concerned with projected or existing radioactive waste repositories, a clear and detailed understanding of the mechanisms of radionuclide transport (both natural and facilitated) is imperative and critical to any realistic performance assessment.

To ensure the compliance of proposed sites and to perform environmental assessments of existing ones, most investigators use predictive models of radionuclide transport that employ laboratory-derived values for a parameter referred to as the radionuclide distribution coefficient (K_d). This parameter is essentially a ratio of the radionuclide activity per unit mass of soil

(aquifer medium) to the radionuclide activity per unit volume of groundwater. The magnitude of this ratio is directly related to the extent to which the radionuclide in question is retarded (or retained by the stationary phase) with respect to the migrating fluid. A number of recent studies have identified significant discrepancies between actual migration rates and those predicted by models for some radionuclides in natural settings (Robertson et al. 1989; and references cited). It is generally acknowledged that transport models based on thermodynamic calculations of radionuclide speciation¹ (Rai and Serne 1978) and laboratory analyses (e.g., studies involving "ideal" radiotracers that may be in some form other than those of the actual mobile species in natural groundwaters) often fail to produce reliable results. This is undoubtedly because these procedures disregard the potential for radionuclide complexation by natural and man-made organic species as well as incorporation of radionuclides in microparticulate or dissolved colloidal material (Bondietti 1982; Champ et al. 1988; McCarthy 1988; McCarthy and Zachara 1989; Petit 1990; Warwick et al. 1991). Consequently, the current study supports the contention that to understand the mechanisms that determine the extent of radionuclide migration or retardation in an existing or proposed setting, it is imperative that species exhibiting facilitated transport be examined in actual field situations and subsequently compared with results from laboratory studies and calculated thermodynamic data. Fundamental information of this sort can then be incorporated into models for more accurate predictions of radionuclide movement from repositories and thereby enhance strategies for site planning or remediation by artificially manipulating retention or mobilization of these species.

¹This term refers to the individual physico-chemical forms of an element, which together make up its total concentration in a sample (Florence 1982).

Several mature low-level waste management and experimental dispersal sites exist at Chalk River Laboratories, Ontario, Canada, and are excellent analogues for shallow burial facilities in humid environments. These sites provide a unique and invaluable opportunity to study the long-term behavior and transport of a number of critical radionuclides (virtually all of those addressed in 10 CFR 61), which have resided in a shallow groundwater flow system for nearly 40 years. The current study was initiated to sample groundwaters from this natural setting, use multifarious techniques to elucidate the speciation of the radionuclides migrating in this environment, and investigate the roles of organic complexation and microparticulates in the facilitation of this phenomenon.

Results of this study point to the existence of complex, heterogeneous, and highly variable

chemical and redox environments that are controlled, at least in part, by the presence of natural organic material in the Chalk River groundwaters. Anionic speciation of most radionuclides predominates in the areas studied, and particle-size and spectroscopic analyses indicate a correlation between these radionuclides and large organic macromolecules, lending support to the premise that naturally occurring humic and fulvic materials are facilitating the transport of radioactive contaminants in the subsurface. Additional evidence seems to suggest that multiple organo-radionuclide complexes are in these waters, and considerable conversion may be occurring between migrating species, both spatially and temporally. This has significant implications with regard to the potential for controlling radionuclide transport to either ensure contaminant retention or facilitate the extraction thereof.

Foreword References

Bondiotti, E.A. 1982. "Mobile Species of Pu, Am, Cm, Np, and Tc in the Environment." In *Environmental Migration of Long-Lived Radionuclides*, IAEA-SM-257/42, International Atomic Energy Agency, Vienna, Austria.

Champ, D.R., J.L. Young, D.E. Robertson, and K.H. Abel. 1985. "Chemical Speciation of Long-Lived Radionuclides in a Shallow Groundwater Flow System." *Water Poll. Res. J. Canada* 19(2).

McCarthy, J.F. 1988. *Role of Colloidal Particles in the Subsurface Transport of Contaminants*. DOE/ER-0384, U.S. Department of Energy, Washington, D.C.

McCarthy, J.F., and J.M. Zachara. 1989. "Subsurface Transport of Contaminants." *Environ. Sci. Technol.* 23:496-502.

Olsen C.R., P.D. Lowry, S.Y. Lee, I.L. Larsen, and N.H. Cutshall. 1986. "Geochemical and Environmental Processes Affecting Radionuclide Migration from a Formerly Used Seepage Trench." *Geochim. Cosmochim. Acta* 44/45:165-170.

Petit, J.C. 1990. "Migration of Radionuclides in the Geosphere: What can we learn from Natural Analogues?" *Radiochim. Acta* 51:181-188.

Rai, D., and R.J. Serne. 1978. *Solid Phases and Solution Species of Different Elements in Geologic Environments*. PNL-2651, Pacific Northwest Laboratory, Richland, Washington.

Riley, R.G., and J.M. Zachara. 1992. *Chemical Contaminants on DOE Lands and Selection of Contaminant Mixtures for Subsurface Science Research*. DOE/ER-0547T, U.S. Department of Energy, Washington, D.C.

Robertson, D.E., M.P. Bergeron, D. Holford, K.H. Abel, C.W. Thomas, D.A. Myers, D.R. Champ, R.W.D. Killey, D.L. Molyaner, J.L. Young, and T. Ohnuki. 1989. *Demonstration of Performance Modeling of a Low-Level Waste Shallow-Land Burial Site*. NUREG/CR-4879 vol. 2, U.S. Nuclear Regulatory Commission, Washington, D.C.

Warwick, P., A. Hall, P. Shaw, J.J.W. Higgs, G.M. Williams, B. Smith, D. Haigh,

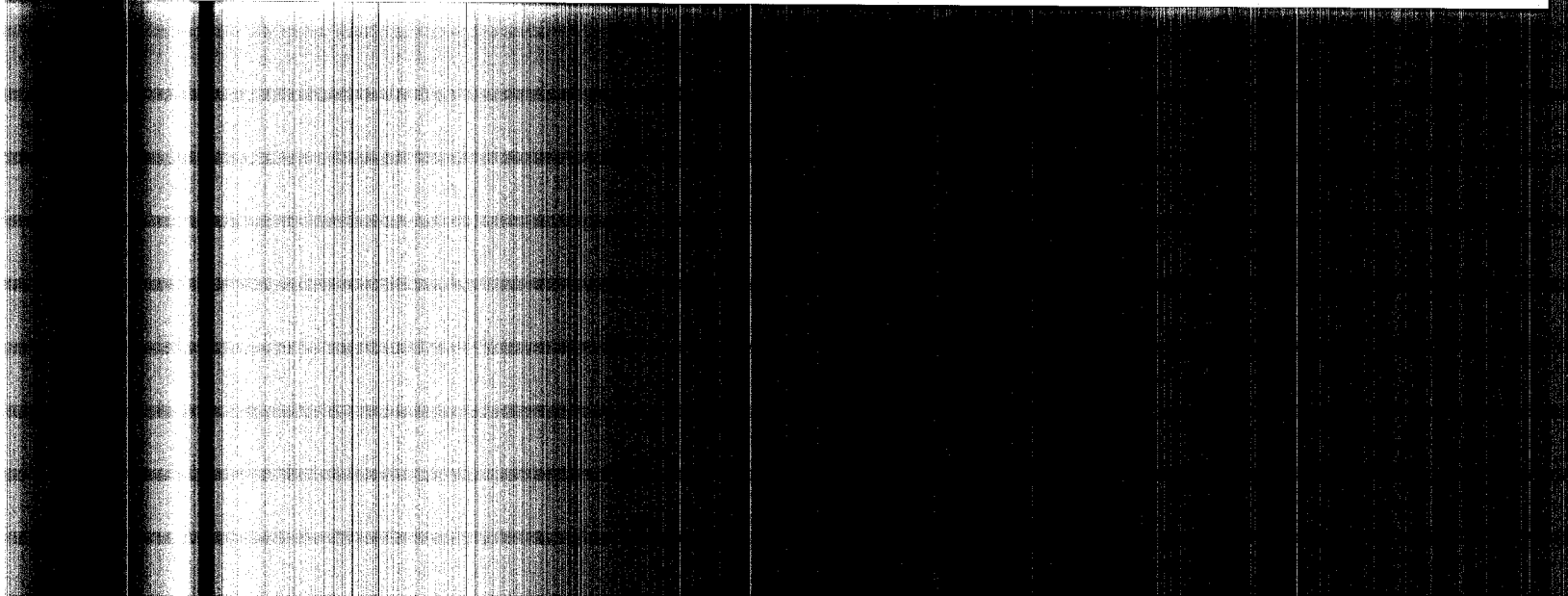

Acknowledgements

Financial support for this work was provided by the U. S. Nuclear Regulatory Commission through a contract with Pacific Northwest National Laboratory.

The authors wish to express their appreciation to the NRC Project Manager, Dr. Edward O'Donnell, of the Radiation Protection, Environmental Risk, and Waste Management Branch, Division of Risk Analysis and Applications, Office of Nuclear Regulatory Research, for helpful guidance and suggestions in conducting this work. The authors also acknowledge and express appreciation to Mr. John W. Craig, Director, Division of Regulatory Applications and Dr. Sher Bahadur, Chief, Waste Management Branch at NRC for their support for this work.

We express appreciation to the Atomic Energy of Canada, Ltd., and the Chalk River Laboratories for sharing their facilities, staff, and expertise in making this collaborative research venture a resounding success.

Without their cooperation and assistance, the important research observations and regulatory implications resulting from this work, which will improve the health and safety aspects of low-level radioactive waste management and disposal, would not have been possible.

We acknowledge the assistance of E.T. McGee and P.J. Durepeau in the collection of groundwater samples. G. Fisher, D.P. Batiste and E.F. Romaniszyn assisted in the preparation of sources for actinide analysis, while J.M. Cox counted the samples on the alpha spectrometers.

We also wish to thank D.S. Hartwig, C. Lafontaine, A. Billo, and especially T.L. Eve, for their help in sample analysis, and R.W.D. Killey for providing electronic copies of the maps used for several of the figures. His comments have helped improve this manuscript. M. Scrimgeour has kindly performed the sand size distribution.

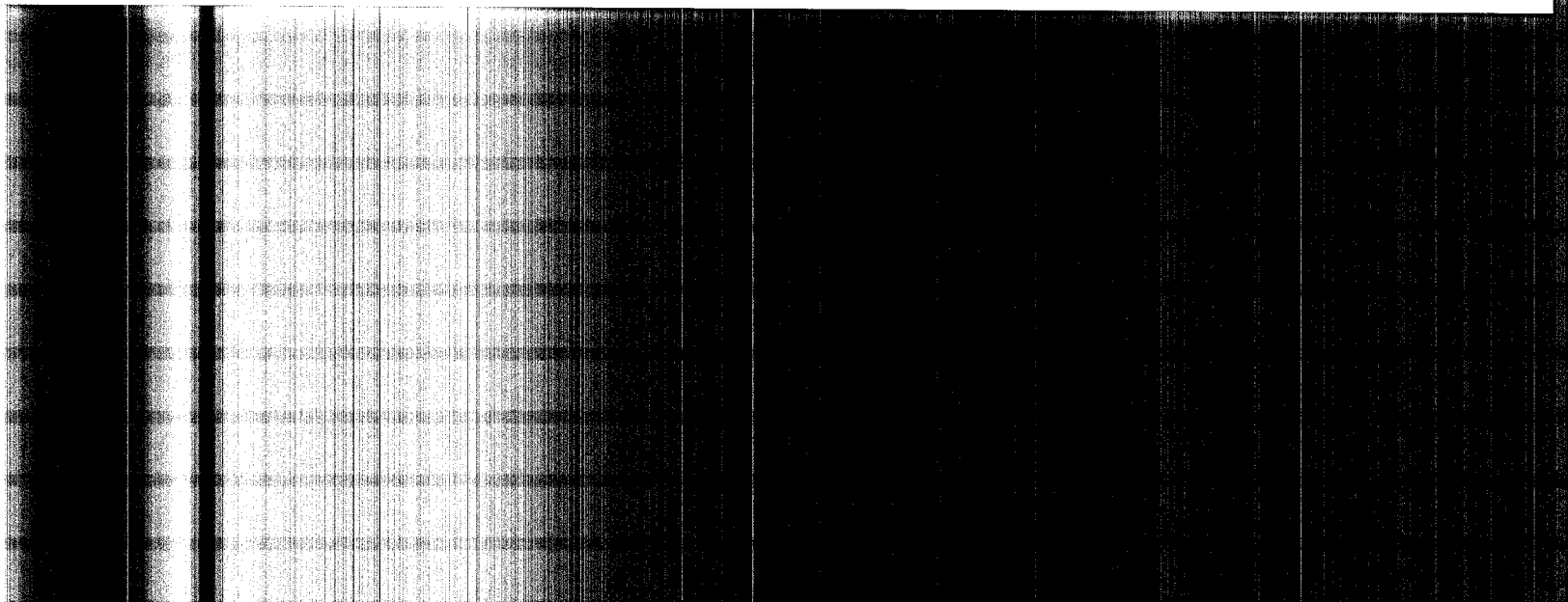

1 Introduction

A major concern regarding the operation of existing and future low-level radioactive waste (LLW) disposal facilities is the ability to adequately model and predict the performance of the site with respect to offsite migration of radionuclides from the disposal facility. Unfortunately, the physical and chemical processes that control the transport of radionuclides by infiltrating groundwater are not well understood.

The migration potential of radionuclides is strongly influenced by the physical and chemical speciation of the radionuclides. For example, radionuclides existing in cationic chemical forms are more readily adsorbed onto soil components, thereby retarding the transport of the radionuclides by groundwater. Conversely, radionuclides which exist in anionic chemical forms migrate at much faster rates because of the poor adsorption onto soil (Cooper and McHugh, 1983; Killey, et al., 1984; Champ and Robertson, 1986; Cooper and Mattie, 1993; Robertson, et al., 1995; Schilk, et al., 1996). Earlier studies have also shown that in the natural environment some cationic species reacted with organic complexants in the groundwater to form anionic organo-radionuclide complexes which exhibit significantly lower K_d 's on soil than predicted by geochemical modeling (Fruchter, et al., 1985). In addition, colloidal species have been shown to transport radionuclides in groundwater over considerable distances (Buddemeier and Hunt, 1988; Penrose, et al., 1990; Robertson, et al., 1995, Schilk, et al., 1996; Kersting, et al., 1999). If the physico-chemical speciation of these radionuclides is modified by organic complexation and/or colloid formation (either natural or man-made), the rate of migration may be dramatically enhanced.

To more fully understand the mechanisms that determine the extent of radionuclide

migration or retardation in existing or future LLW disposal facilities, it is imperative that those species exhibiting transport be examined in actual field situations. Field studies are important because of the occurrence of natural and man-made complexing agents present in groundwater which alter the speciation of radionuclides. Field observations can then be compared with the results of laboratory and thermodynamic modeling predictions to better understand the nature of the complexed species. Empirical data can then be incorporated into transport models for more accurate predictions of radionuclide migration rates from LLW disposal facilities, thereby enhancing the health and safety aspects of radioactive waste disposal.

To assist in the characterization of the processes affecting transport, sampling of groundwater plumes contaminated with radionuclides was conducted at Chalk River Laboratories (CRL) in Ontario, Canada, to identify and quantify the mobile radionuclide species originating from two individual LLW disposal sites. Sampling was conducted at two locations: 1) the Chemical Pit within the Chalk River Liquid Dispersal Area, which has received aqueous wastes containing various radioisotopes, acids, alkalis, complexing agents, and salts since 1956, and 2) Waste Management Area C, a 30-year old solid LLW disposal facility consisting of a series of trenches containing LLW from CRL and various other facilities throughout Canada. These mature LLW management sites are excellent analogues for prospective shallow land burial facilities that are located in environments where precipitation exceeds evapotranspiration. They provide a unique and invaluable opportunity to study the long-term behavior and transport of a number of important radionuclides, many of which have resided in this shallow groundwater flow system for nearly 40 years.

The current study was initiated to: 1) sample groundwater from this natural setting, 2) use multiple analytical techniques to determine the physicochemical speciation of the mobile radionuclides, 3) investigate the role of organic complexation and colloids in the facilitation of radionuclide transport, and 4) determine the soil adsorption properties of the mobile anionic complexed radionuclide species isolated from the contaminated groundwater.

1.1 Background Information

A candidate site intended for use as a facility for the shallow burial of low-level radioactive waste must satisfy the requirements of 10 CFR 61 (Licensing Requirements for Land Disposal of Radioactive Waste), subpart D, section 61.5(2). This regulation states that any proposed site must be capable of being characterized, modeled, analyzed, and monitored. When such facilities are licensed, the primary concern is the means (natural and/or enhanced) by which radionuclides migrate beyond site boundaries. A thorough understanding of these mechanisms could lead to the prevention or minimization of such transport, thereby sparing the general public from undue exposure.

Furthermore, shallow land burial has been routinely used for the disposal of low-level radioactive wastes during which imperfect disposal practices, precipitation infiltration, and groundwater leaching of various waste forms have led to the contamination of many surface and subsurface waters (Riley and Zachara 1992). Despite current waste-management programs, which are intended to modify and/or reduce waste streams and to contain pollutants from past disposals, the active migration of radionuclides from many of the aforementioned sites is an almost ubiquitous phenomenon (e.g., McCarthy 1988; Olsen et al. 1986; and references therein). Whether one is concerned with projected or existing radioactive waste

repositories, a clear and detailed understanding of the mechanisms of radionuclide transport (both natural and facilitated) is imperative and critical to any realistic performance assessment.

To ensure the compliance of proposed sites and to conduct performance assessments of existing ones, most investigators use predictive models of radionuclide transport that employ laboratory-derived values for a parameter referred to as the radionuclide distribution coefficient (K_d). This parameter is essentially a ratio of the radionuclide activity per unit mass of soil (aquifer medium) to the radionuclide activity per unit volume of groundwater. The magnitude of this ratio is directly related to the extent to which the radionuclide in question is retarded (or retained by the stationary phase) with respect to the migrating fluid. A number of recent studies have identified significant discrepancies between actual migration rates and those predicted by models for some radionuclides in natural settings (Fruchter, et al., 1985; Robertson et al. 1989; and references cited). It is generally acknowledged that transport models based on thermodynamic calculations of radionuclide speciation (Rai and Serne 1978) and laboratory analyses (e.g., studies involving "ideal" radiotracers that may be in some form other than those of the actual mobile species in natural groundwaters) often fail to produce reliable results. This can result in underestimation of radionuclide transport because these procedures disregard the potential for radionuclide complexation by natural and man-made organic species as well as incorporation of radionuclides in colloidal material (Bondietti 1982; Champ et al. 1988; McCarthy 1988; McCarthy and Zachara 1989; Petit 1990; Warwick et al. 1991).

Consequently, the current study supports the contention that to understand the mechanisms that determine the extent of radionuclide migration or retardation in an existing or proposed setting, it is imperative that species exhibiting facilitated transport be examined in actual

field situations. The field observations can then be compared with results from laboratory studies and/or calculated thermodynamic modeling to reconcile differences or add further confidence between empirical versus calculated results.

Fundamental information of this sort can then be incorporated into models for more accurate predictions of radionuclide movement from repositories and thereby enhance strategies for site planning or remediation by artificially manipulating retention or mobilization of these species. Results of studies conducted at the slightly contaminated field sites at Chalk River Laboratories' LLW disposal facilities point to the existence of complex, heterogeneous, and highly variable chemical and redox environments that are controlled, at least in part, by the presence of natural organic material in the Chalk River groundwater. Anionic speciation of most radionuclides predominates in the areas studied, and particle-size and spectroscopic analyses indicate a correlation between these radionuclides and large organic macromolecules, lending support to the premise that naturally occurring humic and fulvic materials are facilitating the transport of radioactive contaminants in the subsurface. Additional evidence seems to suggest that multiple organo-radionuclide complexes of each radionuclide are in these waters, and considerable conversion may be occurring between migrating species, both spatially and temporally. This has significant implications with regard to the potential for controlling radionuclide transport to either ensure contaminant retention or facilitate the extraction thereof.

1.2 Description of Experimental Study Sites at CRL

The Chemical Pit is located in the Liquid Dispersal Area near the northern boundary of the Lower Perch Lake Basin (Figures 1.1 and 1.2). The Liquid Dispersal Area has a series of gravel-lined infiltration pits in a

sandy, unsaturated horizon. This area is bounded to the southeast by a steep slope and the East Swamp, and to the southwest by a shallower grade that overlooks another wetland (South Swamp). The Chemical Pit, situated within this area, is composed of a pair of 5-m-deep, gravel-filled infiltration pits (Figure 1.3) that have accepted low-level liquid wastes since the mid-1950s. These wastewaters included a host of radionuclides (activation and fission products) and occasional discharges of small quantities of acids, alkalis, salts, and complexing agents originating from various research and development operations at CRL (Killey and Munch 1984). The disposal of anthropogenic complexing agents at this site has been discouraged since 1961. The local geology in the vicinity of the Chemical Pit (Figure 1.4) is made up of a variety of unconsolidated Quaternary sediments overlying a topographically irregular and locally fractured bedrock of Precambrian granitic to monzonitic gneiss, typical of much of the Canadian Shield. The bedrock is overlain by a sandy till of varying thickness that exhibits a low to moderate silt content with abundant gravel, cobbles, and boulders (often exceeding 3 m in diameter). Above the till is a thin (1 m) layer of clayey silt, which is, in turn, overlain by silty to medium-grained sands with interbedded layers of clayey silt. These sand layers, generally less than 30 m in thickness, are composed largely of quartz (30-40%) and aluminosilicate minerals (30-40%) with associated alteration products (hornblende, biotite-vermiculite, magnetite, garnet), and trace amounts of sulfides, carbonates, organic matter, and hydrated oxides of Fe and Mn (Champ et al. 1985; Killey and Munch 1984; Killey et al. 1984). The lower portion of these sands is probably composed of fluvial deposits, whereas the shallower materials are considered to be aeolian sheet deposits created from the reworking of the fluvial sands.

Precipitation, totaling approximately 75 cm per annum, is distributed evenly throughout the year and recharges a water

table normally less than 5 m from the ground surface. This has led to the formation of swampy areas that contain bog deposits of peat and other organic matter (generally less than 0.5 m in thickness throughout the region. Existing boreholes in this area were used to determine hydraulic head distributions. A subsurface flowpath was found to extend from the Chemical Pit to the East Swamp

(Figure 1.5), with a groundwater residence time of 6 months to 2 years and a mean flow rate of 5 to 25 cm/day. Consequently, three wells along this gradient were selected for sampling near-field (CP-4), far-field (ES-16), and intermediate (ES-39) groundwater in the hopes of observing any temporal changes associated with the migrating radionuclide species (refer to Figures 1.3 and 1.4 for actual well locations).

Figure 1.1 Chalk River Laboratories site location map

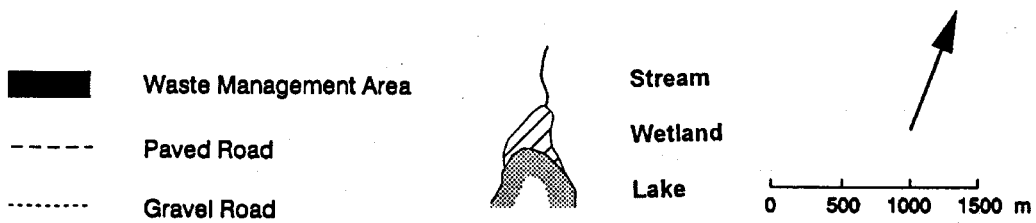
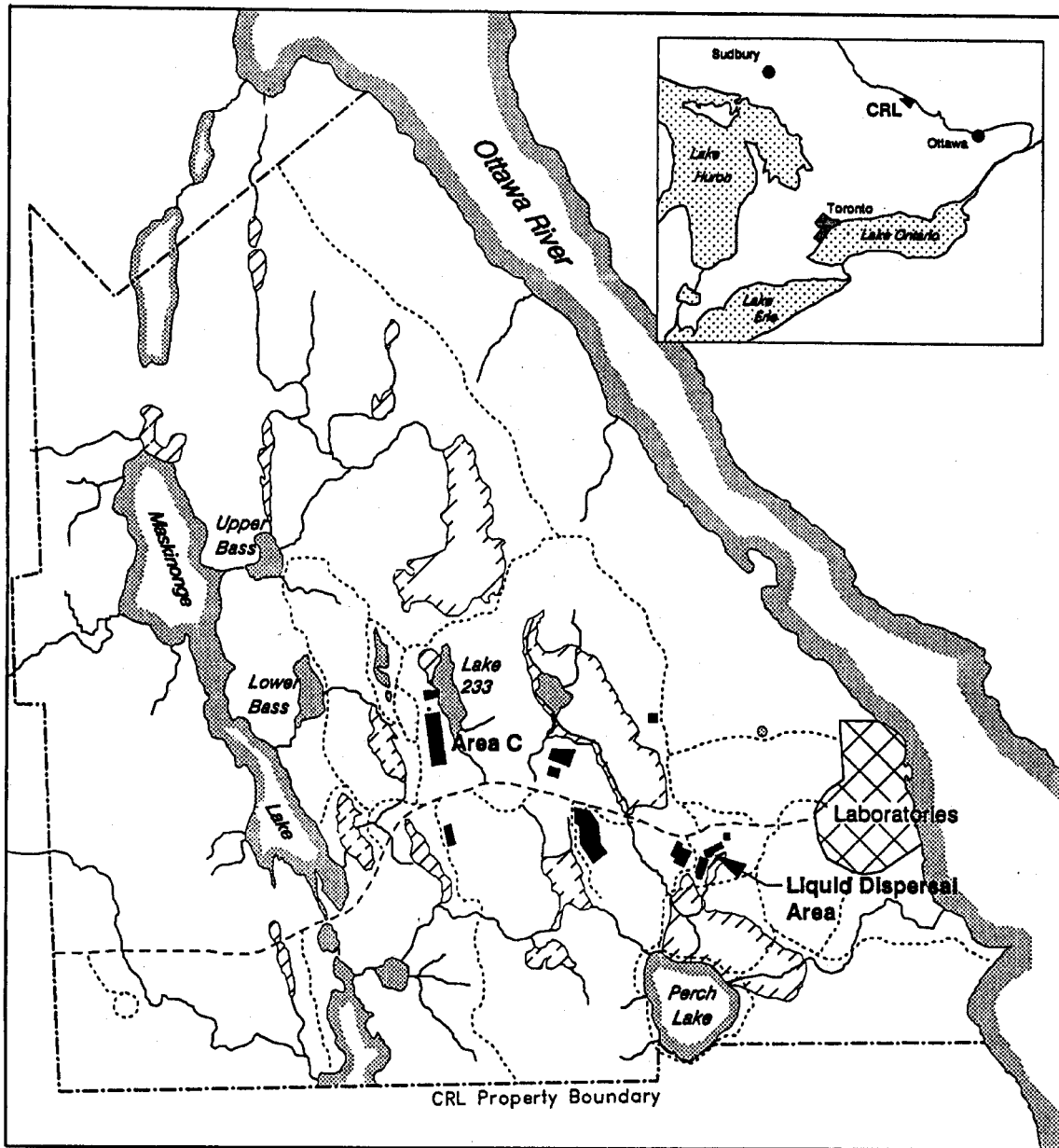

Figure 1.2 Liquid Dispersal Area and Waste Management Area A

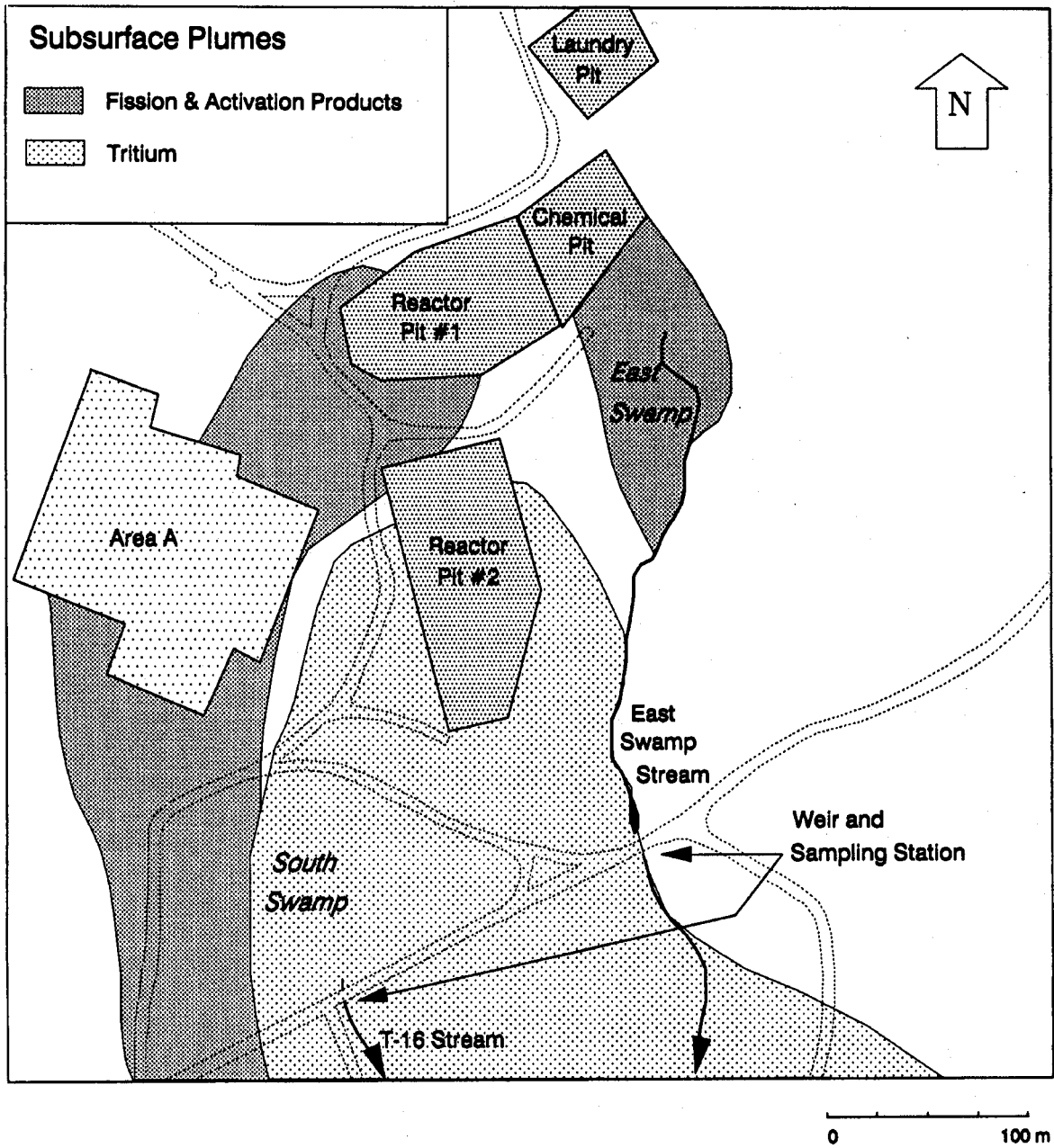

Figure 1.3 Location of boreholes and cross-section in the vicinity of the Chemical Pit

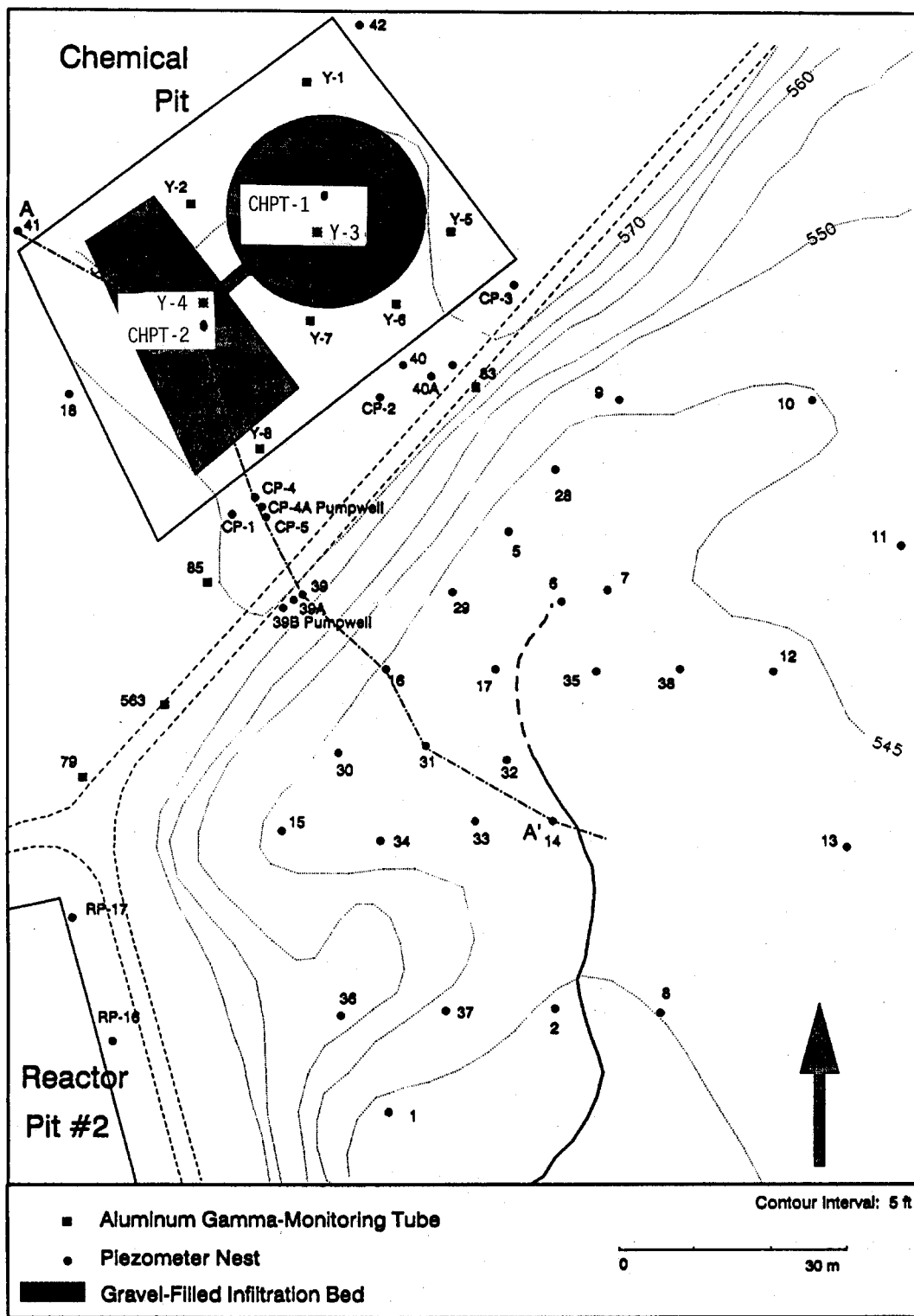
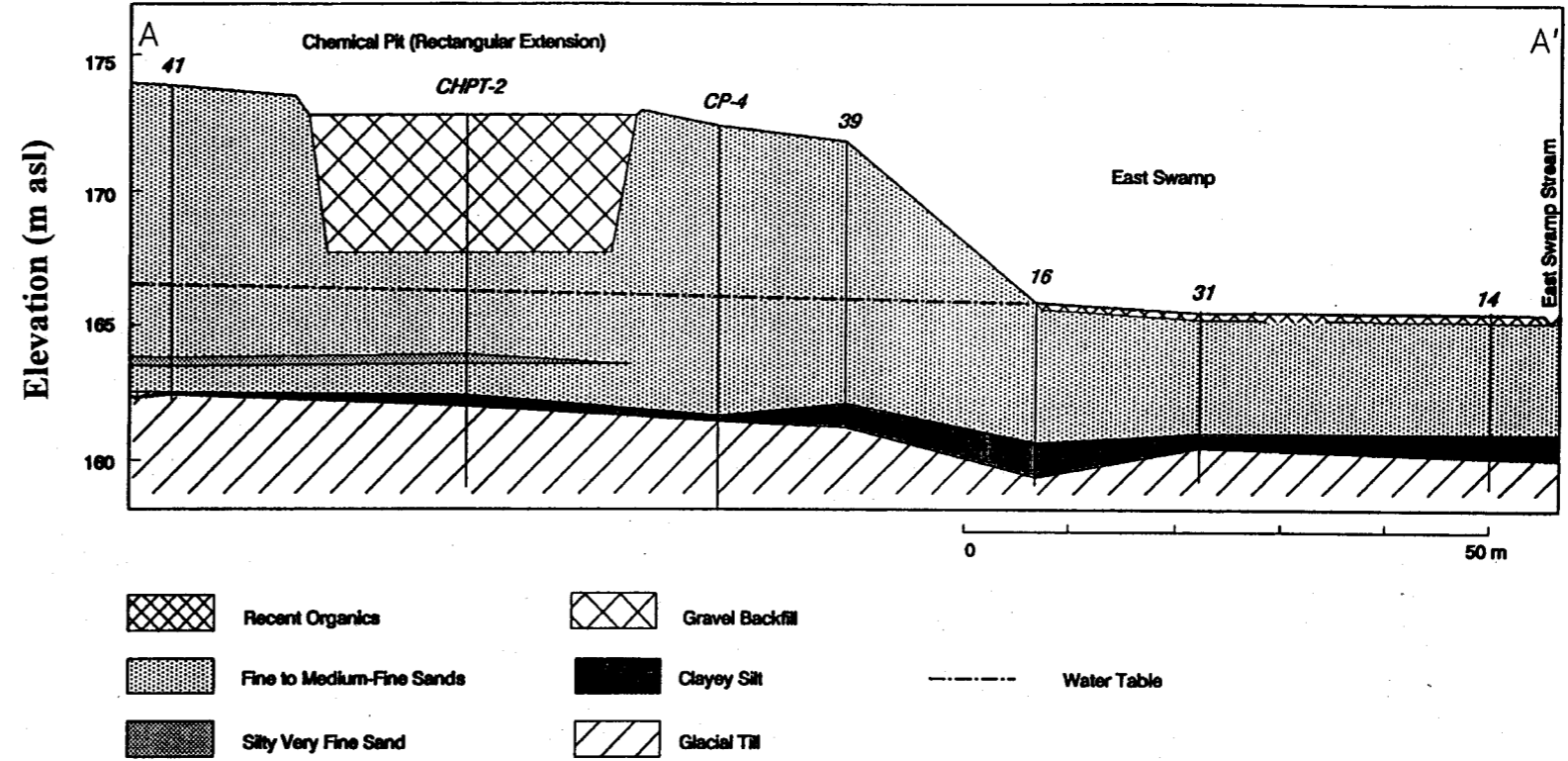

Figure 1.4 Stratigraphic section through the Chemical Pit and East Swamp. Vertical exaggeration 4.5X. Refer to A-A' in Figure 1.3.



1.2.1 Chemical Pit Liquid Waste Disposal Site

The field study site was adjacent to the Chemical Pit infiltration trench in dune sands, located on CRL property approximately 1 km SW of the main laboratory (see Figs. 1.2-1.4). The disposal site consisted of a circular pit, 24 m dia. x 4 m deep, connected to a trapezoidal pit, both excavated in dune sand and backfilled with coarse aggregate.

The Chemical Pit overlies an aquifer that carries water that has infiltrated through the dune deposits, as well as the wastewaters pumped to the pit, southeast to a groundwater discharge area in a perennial wetland (the East Swamp). The base of the gravel backfill of the infiltration pit is about 2 m above the water table. The groundwater flowpath to the discharge area is about 80 to 120 m long. Groundwater residence time in the permeable fine-medium sand is relatively low; estimates of water (and non-reactive contaminant) subsurface travel times ranged from about 180 to 670 d (Killey and Munch, 1984).

Aqueous solutions containing various radioisotopes, acids, alkalis, and/or salts have been discharged to this pit since 1956, although available data indicate that the inputs of non-radiological contaminants were generally very low. Nearly 331,000 m³ of waste water, containing approximately 230 TBq (TBq = 10¹² Bq) or 6200 Curies of beta emitters (liquid + solids) and 0.31 TBq or 840 Curies of alpha emitters has been discharged to this pit (Welch and Killey, in prep.) A variety of activation and fission products, a number of which were gamma emitters, were present in the waste water. The pit was used regularly for waste water discharges until 1992, and a few intermittent releases were recorded during the period of 1993-1995. A series of interception wells, installed downstream from the pit in 1994, now supply water to a treatment plant where radionuclides are removed.

The mineralogy consists of quartz and feldspars (each making up 30-40%), with minor or accessory muscovite and

ferromagnesian minerals (hornblende, biotite-vermiculite, magnetite, garnet).

The concentrations of radionuclides in the aquifer have decreased in recent years because of radioactive decay and the discontinuation of the routine use of the infiltration pit as a waste management facility. Nevertheless, a wide variety of radioisotopes remain detectable in the aquifer. Multiple chemical species of a number of radionuclides (including ⁶⁰Co, ¹⁰⁶Ru, and ^{239/240}Pu), first identified in the early 1980's (Cooper and McHugh, 1983; Killey et al., 1984; Champ et al., 1984; Champ and Robertson, 1986) have also remained present in the contaminant plume (Cooper and Mattie, 1993; Robertson et al., 1995; Schilk et al., 1996). Some of these (e.g., ruthenium) would be expected to form inorganic anionic complexes, but the anionic forms of other radioisotopes (including cobalt and plutonium) have been attributed to the formation of complexes with dissolved organic compounds, most probably of natural origin. The persistence and stability of the organo-radionuclide complexes, and the inference that the organics are of natural origin, and hence, likely to be commonly encountered in other flow systems, indicate that they may often influence the migration of radioisotopes. It is also probable that their effects have not been present in many of the laboratory experiments that have been used in developing K_d databases. This study was undertaken to investigate the effects of these aquifer complexes on sorption coefficients with geological material.

A previous sampling effort in July of 1980 (Killey and Munch 1984) indicated that the major ion loading at the Chemical Pit was rather low, and total dissolved solids in the contaminant plume were not substantially different from local uncontaminated groundwater (Table 1.1). The key distinguishing features of the plume, apart from the presence of radionuclides, were elevated Na and chloride concentrations, elevated Eh, and lower dissolved iron (Fe²⁺) concentrations compared to nearby groundwaters. It was also noted during this study that sands within the Chemical Pit plume had significantly heavier surface

coatings of iron oxyhydroxides than did equivalent sands outside of the plume boundaries. These coatings were interpreted to be a direct result of the more oxidizing conditions associated with the plume environment relative to the surrounding, uncontaminated waters, which led to the formation of insoluble ferric (Fe^{3+}) compounds.

Weekly records of streamflows and total beta-gamma-emitter concentrations have been maintained for the East Swamp Stream. This stream provides a potential discharge path for the plume contaminants, since 1965. Radiochemical analyses and gamma-ray spectrometry were performed on quarterly composites of the stream water from 1974 to 1992. Currently, these are done on a monthly basis, as are tritium and gross-alpha analyses. Since 1989, the average annual pH has ranged from 5.5 to 6, and the conductivity has ranged between 300 and 600 S/cm.

Perhaps the most significant event in the operational history of the Chemical Pit occurred in 1961 when a solution containing appreciable quantities of citrate (and, possibly, a number of other complexing agents) was discharged to the pit. This event was followed 3 months later by a marked increase in ^{90}Sr concentration and the first appearance of ^{60}Co in the East Swamp Stream. The presence of citrate and other complexing agents was apparently responsible for these phenomena

and may have dissolved the previously adsorbed cationic species and facilitated their transport toward the discharge zone.

Another large increase in East Swamp Stream radionuclide concentration occurred in 1990 (Figure 1.6). The total beta-gamma and ^{90}Sr concentrations were observed to rise dramatically throughout the year, resulting in average annual concentrations that were roughly an order of magnitude greater than those observed during the previous year. These were accompanied somewhat later by relatively smaller increases in the concentrations of ^{60}Co and ^{106}Ru (Figure 1.7). The reasons for this rise in radionuclide concentrations in the East Swamp Stream have not been determined, and sampling results since 1989 have provided no indications of appreciable changes in the conductivity or pH of the discharged wastewater. Although these results do not include analyses for complexing agents, groundwater sampling during the summer of 1991 failed to detect any complexed forms of ^{90}Sr . The presence of complexing agents, major shifts in groundwater pH, or stable elements that might compete with radionuclides for sorption sites on the aquifer sands are expected to be observed at the East Swamp Stream within a few months of the discharge event, as indicated above. However, no such precursors to the enhanced contaminant concentrations have been identified.

Figure 1.5 Water table contours in the vicinity of the Chemical Pit

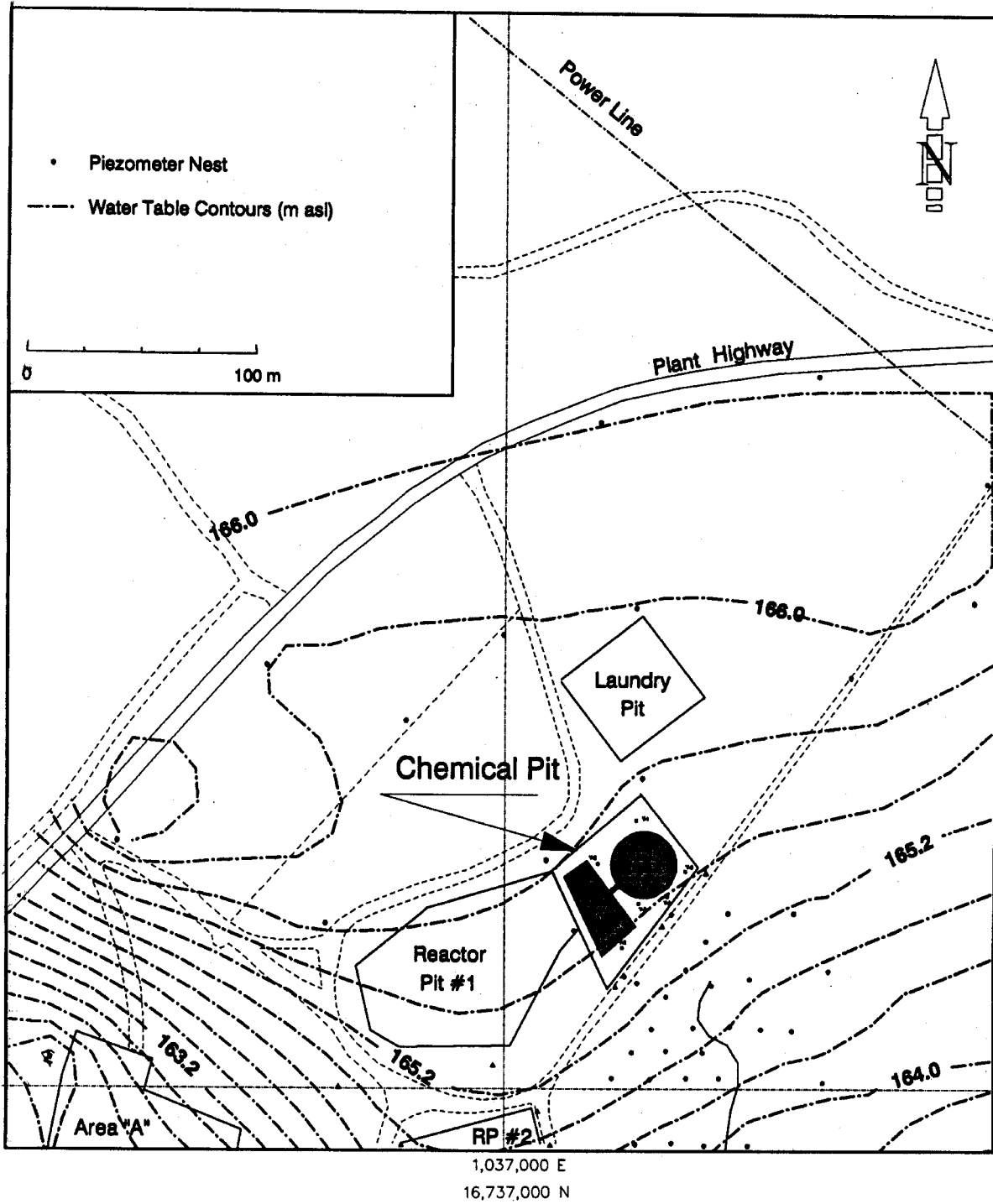

Figure 1.6 Annual average concentrations of total beta-gamma activity and ⁹⁰Sr at the East Swamp Stream weir (1965-1993)

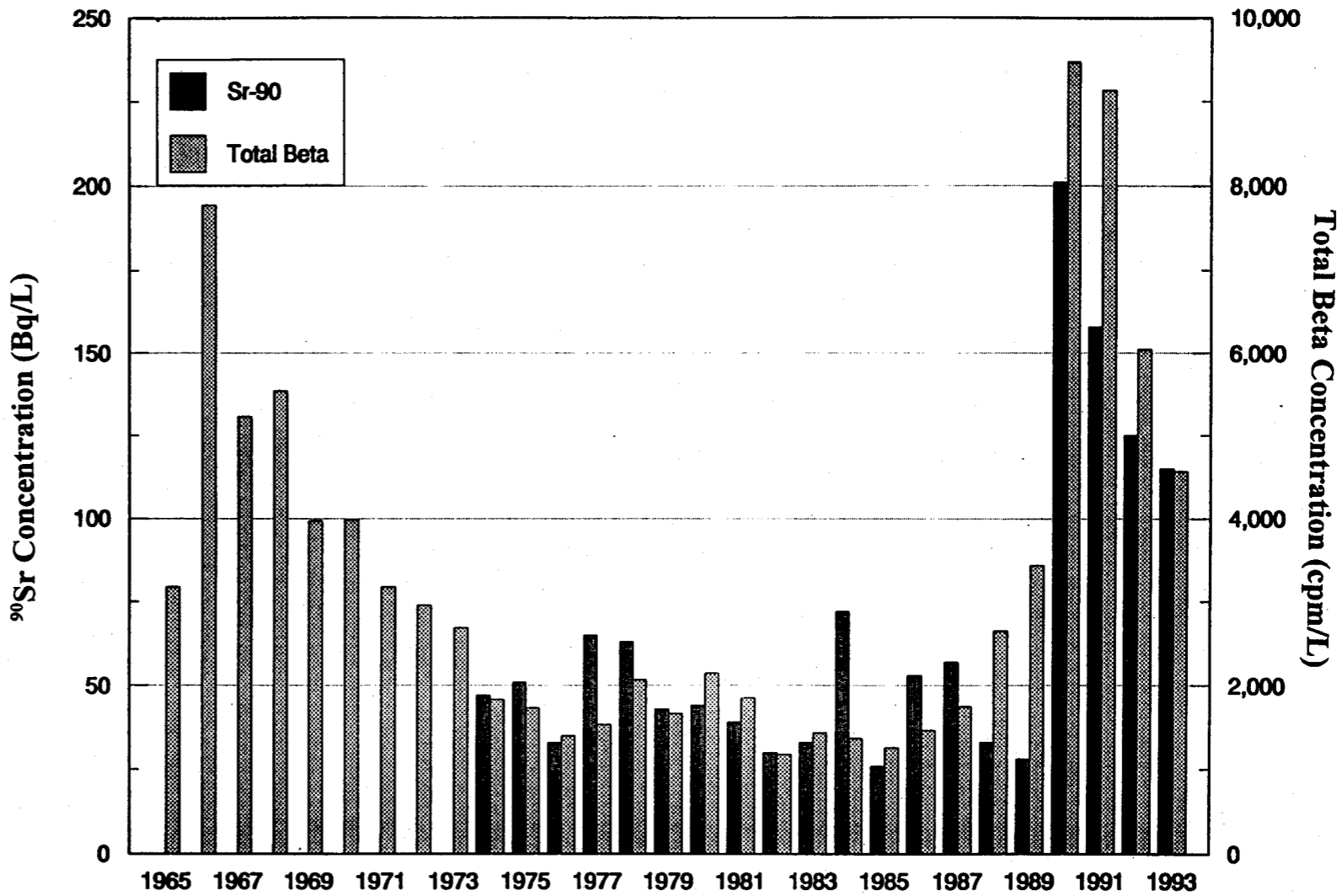
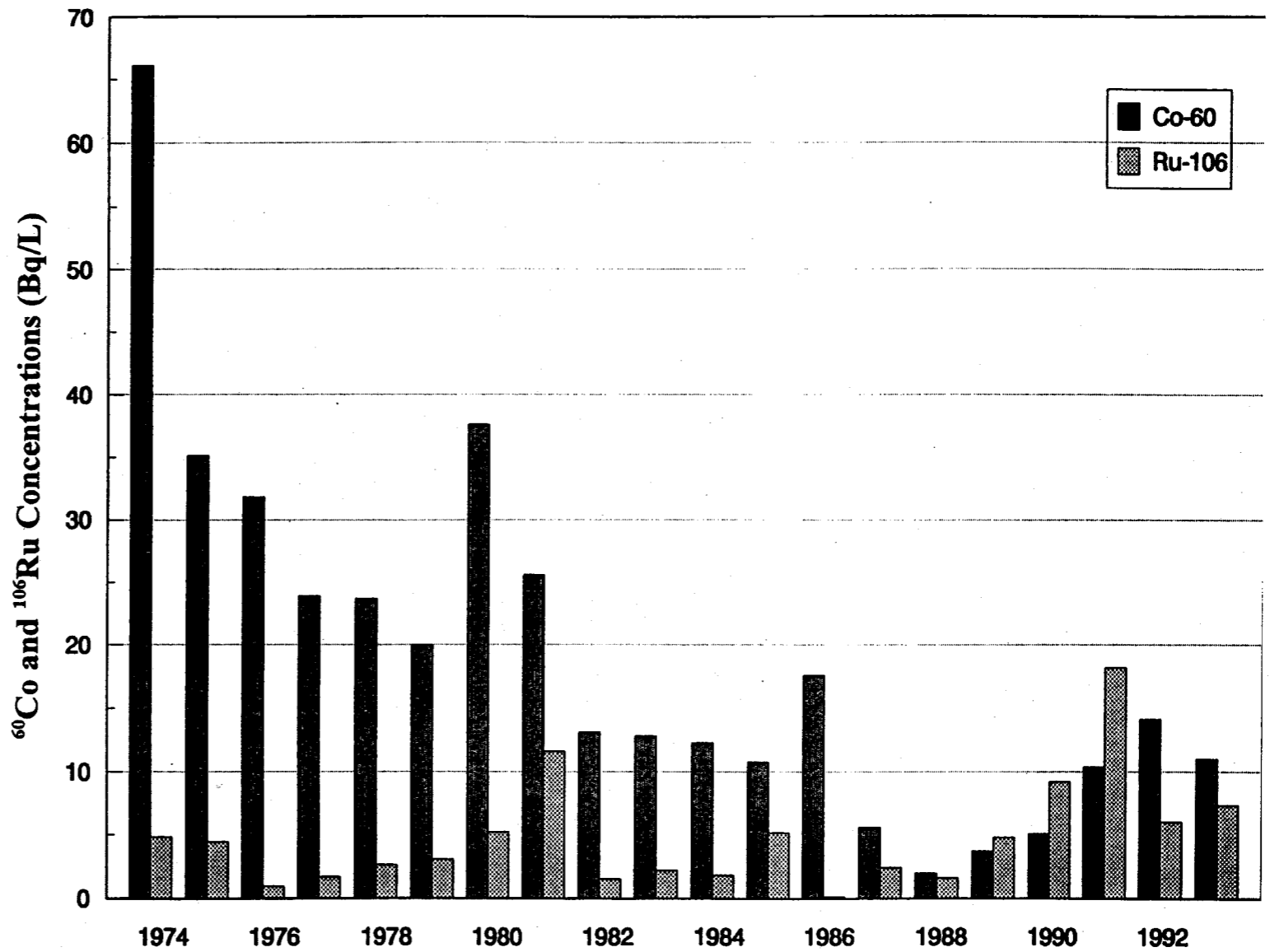

Figure 1.7 Annual average concentrations of ^{60}Co and ^{106}Ru at the East Swamp Stream weir (1974-1993)



It may be that the increases in radionuclide concentrations at the East Swamp Stream are the result of some much earlier perturbation in the Chemical Pit influent. The effects of such changes might not be evident in the discharge zone for many years if radionuclide migration rates were retarded by reversible or partially reversible sorption reactions. Records from the analyses of disposed waters show that the release of Sr to the Chemical Pit in 1978 was approximately three times larger than releases in previous and subsequent years. A comparison between this 12-year delay (from the time of the ^{90}Sr release to the observed increase at the East Swamp Stream) and the 3-month delay observed in the 1961 event leads to a ^{90}Sr K_d of around 12 mL/g. This is in reasonable agreement with ^{90}Sr radioactivity distribution coefficients observed in other CRL aquifers (e.g., Robertson et al. 1987), making it tenable to propose that the observed increase in East Swamp Stream radiostrontium in 1990 is a direct result of the discharges in 1978. This hypothesis does not address the accompanying increases in ^{60}Co and ^{106}Ru , yet these enhancements fall within the ranges of variability observed for these isotopes over the past decade. According to Champ et al. (1985), the total inventory of ^{60}Co on the aquifer matrix downgradient of the Chemical Pit was 10 Ci, while the quantity of alpha emitters disposed of at this site was estimated to be 5 Ci.

Earlier investigations (Champ et al. 1985; Killey et al. 1984) identified radioisotopes of Co, Zr, Ru, Sb, Cs, Ce, Eu, Fe, Sr, Ni, I, Tc, Pu, Am, and Cm in downgradient water samples. Nonetheless, routine monitoring of Perch Lake, which receives drainage from this waste pit and other nearby waste-management areas, indicates that radionuclide concentrations do not exceed levels permissible for drinking water (Killey et al. 1984). The only exception is ^{90}Sr , which is present at Perch Creek Weir at an average concentration of 160 pCi/l, compared to the present drinking water standard of 135 pCi/l. (Cooper, 1999)

1.2.2 Area C Solid Waste Disposal Site

Waste Management Area C (Figures 1.1 and 1.8-1.10) includes a series of unlined trenches excavated from a large sand ridge that forms the southern margin of a nearby intermittent lake (Lake 233). This facility is still in operation and has received low-level radioactive wastes (paper, plastic, wood, metal, glass, liquid scintillation cocktails, organic and inorganic chemicals, etc.) from CRL, industry, hospitals, and universities throughout Canada since 1963. Until 1983, wastes were placed in trenches approximately 5 m deep (above the water table), 7 m wide, and 60 m long, oriented parallel to the short axis of the rectangular site. After being filled with low-level radioactive waste, the trenches were covered with about 1 m of local sand and sandy topsoil. Since 1983, wastes have been placed within a large trench and covered with sand as the face of the fill advances. The southern portion of the site has been covered with a high-density polyethylene membrane and a tile drainage system to minimize precipitation infiltration (Figure 1.8).

Terrain to the northeast of Lake 233 is primarily bedrock with a thin, sandy till cover (see Figure 1.9). There is intermittent overland runoff from this area into Lake 233, which may contain up to 1 m of water in spring, but is normally almost dry in late summer. This lake has no surface drainage channel; therefore runoff that enters the lake from the northeast (as well as direct precipitation that exceeds evapotranspiration losses) drains by infiltration into the bed of the lake.

Apart from a basal wedge of bouldery till, the unconsolidated sediments in Area C consist of fine and medium-fine sands of fluvial origin overlain by a unit of interstratified, very-fine to fine sands and sandy silts. This interstratified unit is overlain by fine and medium-fine sands that make up the dune ridge hosting Area C. A unit of very extensive, continuous,

laminated clayey silts (generally less than 30 cm in thickness) is present along the margin of and beneath the wetland located about 250 m southwest of the waste-management facility. This wetland, known as Duke Swamp, contains up to 3 m

of peaty organics. The southwest boundary of this wetland, as well as that of the groundwater flow system itself, is a bedrock ridge that trends roughly northwest to southeast.

Table 1.1 Major Ion Chemistry in the Chemical Pit Vicinity in 1984 (from Killey and Munch, 1984). Refer to Figure 1.3 for Well Locations. Major ion loading was rather low and total dissolved solids in the contaminant plume were not substantially different from local uncontaminated groundwater.

Well No./ Depth (m)	pH	Eh (mV)	Ca	Mg	Na	K	Fe	Cl ⁻	SO ₄ ²⁻	HCO ₃ ⁻	F ⁻	NO ₃ ⁻
			Concentration (mg/L)									
ES-9/1.0	5.98	130	3.7	0.85	2.2	1.34	6.3	0.8	5.7	15.4	0.21	0.0
ES-9/2.0	5.78	260	6.3	1.66	2.5	1.20	1.6	0.8	18.5	10.4	0.11	0.5
ES-9/3.0	5.85	100	5.5	1.87	2.6	1.26	2.5	0.7	8.8	21.2	0.13	0.0
ES-12/1.0	5.81	270	7.9	4.10	4.4	1.27	0.8	1.5	14.6	28.6	0.21	0.4
ES-12/1.5	6.40	160	21.2	6.70	4.5	2.23	1.1	1.0	11.3	84.8	0.17	0.3
ES-12/2.0	6.61	100	10.0	6.00	3.9	1.85	21.0	1.0	0.1	116.0	0.17	0.0
ES-13/1.0	5.82	80	7.4	3.40	4.3	1.10	4.2	2.5	16.2	23.6	0.23	0.0
ES-13/2.0	5.87	70	12.5	4.80	4.6	1.60	6.2	2.9	11.0	41.7	0.29	0.0
ES-5/0.6	5.15	660	2.4	0.70	3.0	1.15	0.1	2.3	9.2	10.0	0.25	1.0
ES-5/1.8	4.60	470	1.5	0.79	6.3	1.00	0.1	1.5	14.7	41.0	0.10	4.4
ES-5/2.4	5.70	330	3.7	2.30	3.8	1.65	3.0	0.5	12.5	21.8	0.20	0.0
ES-14/1.0	7.06	210	17.1	4.90	4.1	2.60	0.3	9.6	12.8	80.3	0.18	0.7
ES-14/2.0	7.32	230	31.2	9.00	3.0	1.00	0.1	13.5	28.0	97.5	0.13	4.0
ES-15/1.0	5.40	310	0.9	0.29	8.0	0.80	0.4	7.7	6.3	14.3	0.09	0.0
ES-15/2.0	5.50	310	4.4	0.81	11.1	1.90	0.3	9.3	5.8	24.9	0.25	0.0
ES-15/2.5	5.15	280	5.1	1.07	12.0	1.98	1.3	12.3	7.0	28.8	0.07	0.0
ES-1/1.06	5.40	650	0.7	0.52	13.0	0.86	0.3	12.8	10.7	14.5	0.15	3.0
ES-16/1.5	5.65	640	0.4	0.47	16.8	0.55	0.3	16.0	8.1	19.9	0.00	5.8
ES-16/2.0	6.28	540	1.0	4.40	16.2	0.49	0.5	16.4	11.4	83.4	0.39	0.0
ES-16/2.5	5.50	560	2.0	0.55	16.6	0.84	0.1	12.5	9.2	40.8	0.15	0.0
ES-17/1.0	4.75	360	1.7	0.49	7.3	1.04	0.1	0.6	12.5	10.0	0.12	2.5
ES-17/2.0	5.10	300	2.4	0.67	5.4	1.14	0.9	0.6	14.7	6.1	0.05	0.0

As mentioned previously, much of the recharge from Lake 233 that passes beneath Waste Management Area C flows southwest (see Figure 1.10) through the unconsolidated sediments, and direct precipitation infiltration through Area C and downgradient sands is added to the aquifer en route. Groundwater from this flowpath discharges to Duke Swamp and

subsequently drains by overland flow through Duke Stream to Maskinonge Lake. Groundwater flowrates range from 15 to 30 cm/day, leading to a total residence time of approximately 2 to 4 years between Area C and the wetland (Killey et al. 1993). Additionally, the groundwater flow downgradient of Area C bifurcates (Figure 1.10), such that those waters passing

beneath the south end of the facility are diverted almost due south, flowing beneath the site highway and discharging to another wetland (which in turn drains through Bulk Storage Stream). This

bifurcation is caused by a partially buried bedrock ridge that trends north-northwest and outcrops just east of the southern end of Duke Swamp.

Figure 1.8 Borehole and cross-section locations near Waste Management Area C

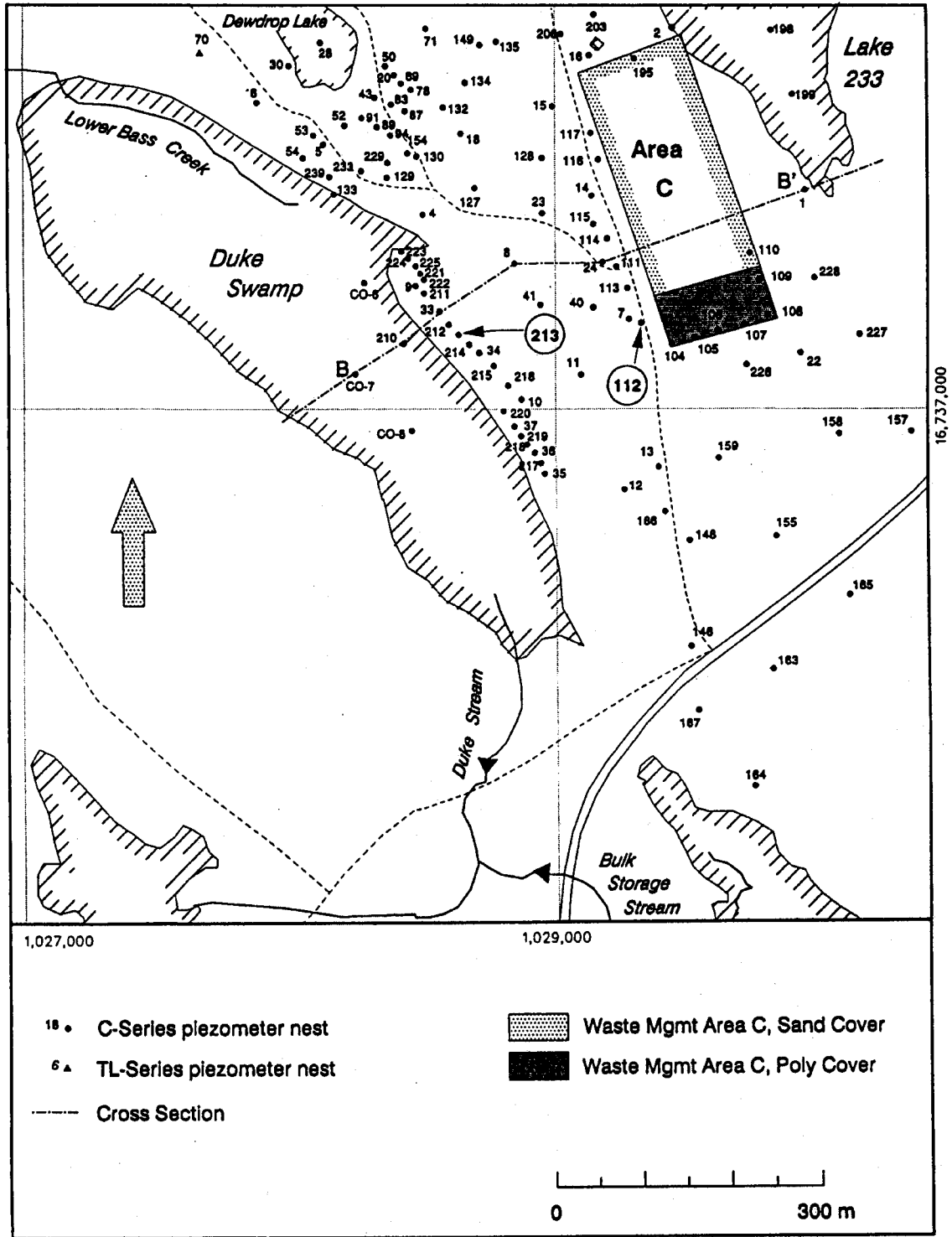
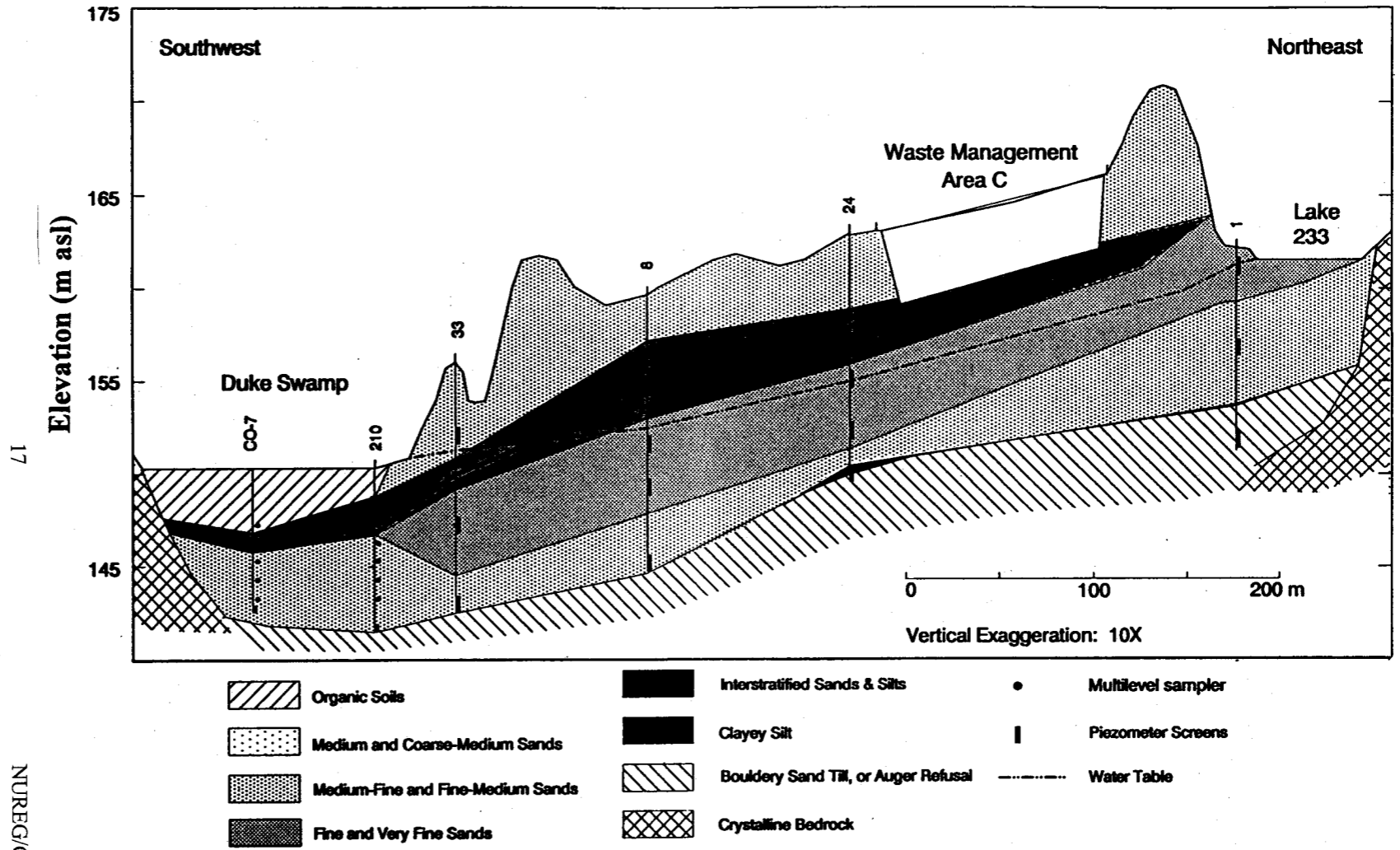

Figure 1.9 Stratigraphic section through Area C and the Duke Swamp groundwater discharge area. Refer to B-B' in Figure 1.8.



17

NUREG/CR-6627

Figure 1.10 Surface hydrology, water table contours, and areal extent of groundwater contamination by ^3H (bifurcating, medium-gray pattern) in the vicinity of Area C. Dots indicate piezometer nest locations (refer to Figure 1.8 for nest identifiers).

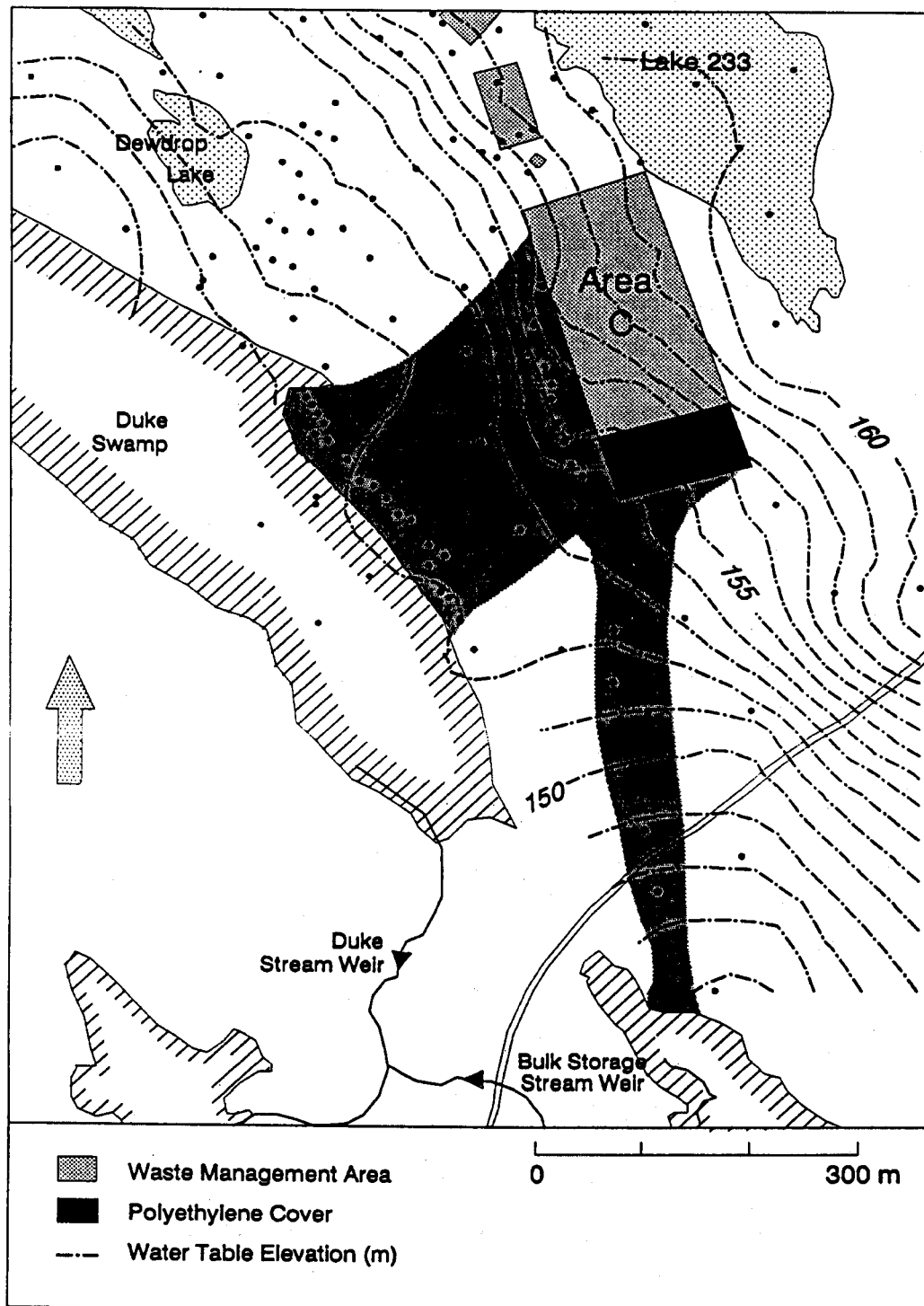
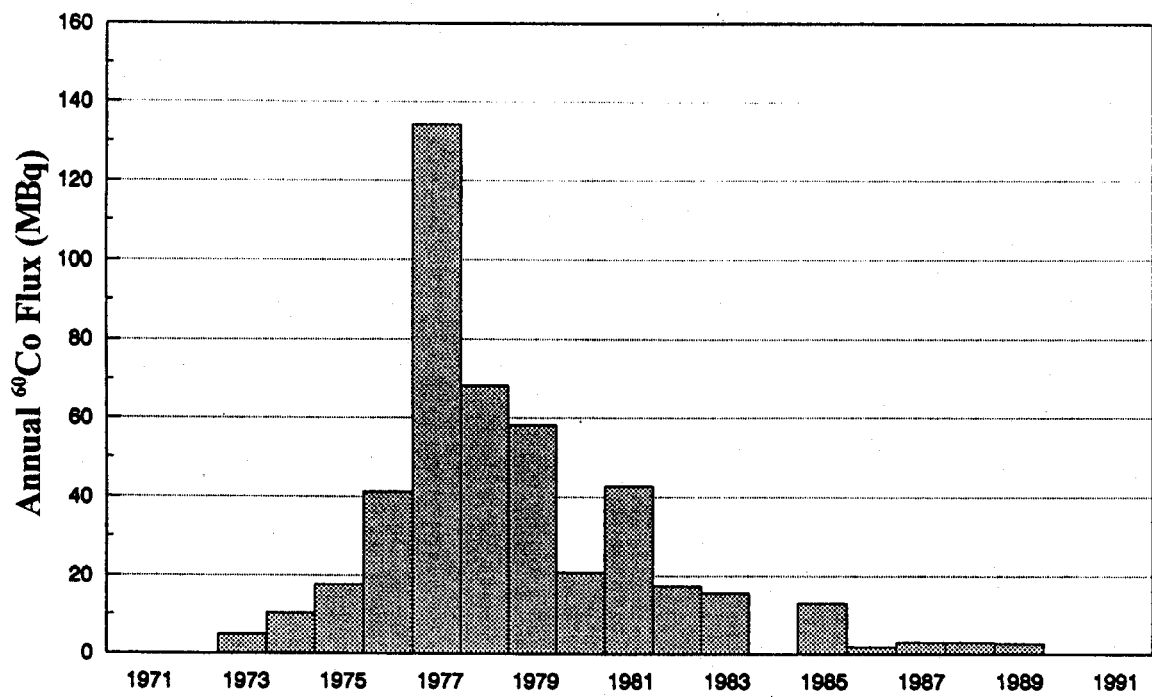
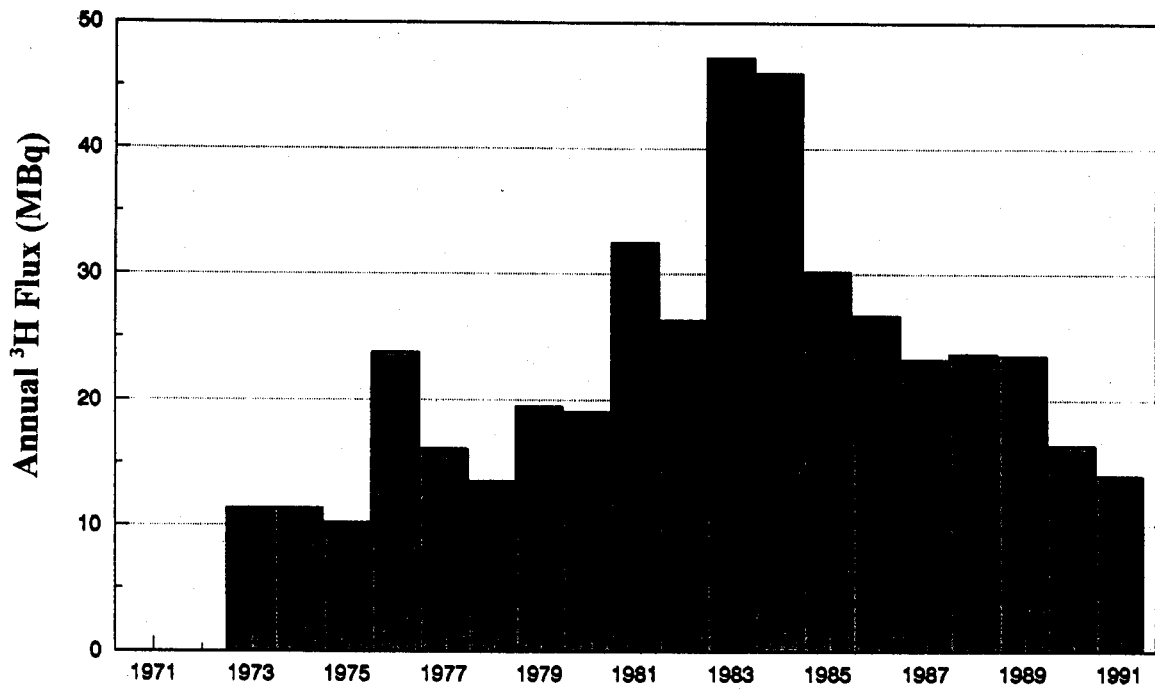

Figure 1.11 Annual flux of ^3H and ^{60}Co through the Duke Stream weir



1.2.3 Previous Related Chemical and Radiological Characterization

Some groundwater outside of the Area C plume is affected by salt used for road de-icing, but is otherwise uncontaminated. Table 1.2 summarizes the major ion chemistry for these surrounding groundwater and for samples collected from the Area C plume. Boreholes C-112 and C-212 (refer to Figure 1.8 for locations) were sampled for anthropogenic organic compounds in 1991, and Table 1.3 lists the compounds that were detected.

Tritium is the primary radionuclide of concern at this site in terms of quantity, although ^{14}C and ^{60}Co have also been detected in downgradient water and vegetation. Area C began releasing ^3H to the aquifer before 1973 when routine monitoring of local surface waters was initiated (see Figure 1.11). Tritium in water downgradient of the covered portion of Area C has virtually disappeared, however, since the fall of 1985 (Killey and Munch 1993), and this can be attributed to the impermeable polyethylene cover installed in 1983. Although this barrier appears to have eliminated the infiltration of precipitation and consequent release of tritiated water from this locale, ^{14}C apparently is still migrating from the area. Tritium releases continue from that portion of the site that has no cover, but analyses from the streams that drain the groundwater discharge area that receive the Area C water has shown a declining trend in ^3H releases since 1983.

When regular measurements of Duke Stream were initiated in 1973, low concentrations of ^{60}Co were detected (Figure 1.11). The ^{60}Co flux peaked at 3.6 mCi per annum in 1977 and has decreased in a roughly exponential fashion since that time. At present, this radionuclide is only marginally detectable in Duke Stream, exhibiting an annual flux of less than 81 μCi . No program currently exists for

mapping ^{60}Co distribution in the contaminated aquifer or the groundwater discharge area.

Surveys in 1982 and 1983 detected elevated ^{14}C in vegetation growing in and adjacent to the Area C compound with specific activities approaching 1.1 nCi/gC. In 1990, a study of soil gas and groundwater around Area C found specific activities up to 1.3 Ci/gC in soil CO_2 above the waste trenches and ^{14}C concentrations in downgradient waters of up to 34 nCi/L (Killey and Mattie 1993). Further studies from 1991 to 1993 addressed the distribution of ^{14}C in dissolved inorganic and organic forms (Killey et al. 1993). Dissolved organic carbon (DOC) was generally found to account for less than 10% of the dissolved ^{14}C in these samples (Table 1.4). This is because the DOC in the ground and surface water is less abundant than the dissolved inorganic carbon (DIC), and the specific activity of the former is generally lower than that of the latter. The variability in the distribution of ^{14}C between the two classes of compounds is attributed to variability in the source area. Although these data suggest that most of the ^{14}C inventory in Area C is in inorganic forms, a portion of the dissolved inorganic ^{14}C most likely originates from CO_2 produced during the bacterial degradation of radiocarbon-bearing organic materials. The DIC and DOC concentrations in the Area C plume waters range from background levels to about 3 and 8 times background, respectively.

Recent studies of ^{14}C in the environs of Duke Swamp have characterized the transport and biological uptake from groundwater-to-air-to-vegetation (Link, et al., 1998; Milton, et al., 1997). These studies have shown that the predominant pathway for ^{14}C uptake by vegetation growing in Duke Swamp is via the groundwater-to-air-to-leaf route, and uptake of ^{14}C by transpiration through the root system is essentially negligible.

Table 1.2 Major ion chemistry within and adjacent to the Area C contaminated groundwater plume. Refer to Figure 1.8 for well locations.

Well No./ Depth (m)	pH	Eh (mV)	Ca	Mg	Na	K	Fe	SiO ₂	HCO ₃ ⁻	Cl ⁻	SO ₄ ²⁻	F ⁻
			Concentration (mg/L)									
1/16.4	6.80	164	16.3	5.3	3.8	1.1	29.0	33.8	93.8	47.0	0.9	--
1/5.4	5.70	235	5.5	2.2	21.2	1.3	6.0	12.8	25.9	54.0	5.5	--
2/9.2	6.35	82	14.2	5.0	3.7	1.1	6.5	28.9	35.0	5.6	16.3	--
2/2.5	5.80	284	6.6	2.5	7.0	2.2	0.1	13.1	18.1	9.2	9.9	--
3/11.0	7.10	44	15.3	6.7	3.1	1.3	8.6	30.4	11.6	3.4	--	--
3/4.1	5.50	254	8.2	2.1	4.1	1.3	0.3	13.5	24.5	7.0	10.6	--
4/9.4	6.65	124	8.0	3.2	7.4	1.0	19.1	14.6	44.0	13.4	18.5	0.1
7/15.6	6.50	119	8.9	2.8	5.9	2.3	12.2	20.3	48.1	9.6	12.4	--
7/11.8	6.20	176	10.8	3.2	10.1	1.8	11.8	11.1	30.8	34.0	10.3	0.1
8/14.5	6.84	90	8.3	2.8	5.6	1.6	17.9	21.0	79.3	7.3	11.0	--
8/14.5	6.41	154	9.2	2.8	7.2	1.2	15.8	17.6	46.3	17.4	11.9	0.1
8/10.3	6.32	265	12.6	3.6	5.9	1.1	0.3	14.8	35.8	11.3	12.8	0.0
8/8.1	6.60	233	5.0	1.3	5.7	1.9	0.1	15.4	26.3	2.0	10.6	--
8/8.1	6.30	294	11.0	2.7	12.8	1.3	0.1	10.7	44.9	11.1	12.4	0.0
9/14.1	6.30	239	17.9	7.1	16.7	1.7	0.7	12.0	93.0	15.5	20.0	--
9/11.1	6.00	374	32.1	9.1	37.1	2.9	0.5	19.1	77.1	47.0	41.4	--
9/11.1	6.04	334	26.0	7.6	19.3	2.3	0.8	11.1	93.0	36.0	30.0	--
9/7.2	5.90	334	3.8	1.3	0.8	1.3	0.1	12.4	10.9	0.3	10.1	--
9/7.2	6.14	327	20.4	6.0	15.3	2.0	0.8	11.8	9.1	47.5	33.7	--
10/4.8	6.70	114	8.5	2.7	5.7	1.0	17.2	21.4	62.1	12.5	5.4	0.2
10/2.6	6.32	274	3.6	1.3	3.4	1.4	0.7	13.1	16.3	2.8	9.0	--
14/9.5	6.30	219	8.0	2.2	8.1	1.5	3.7	11.1	24.9	18.7	13.2	0.1
14/7.1	6.15	243	9.5	2.7	9.0	1.6	1.8	10.9	24.7	17.6	18.2	0.1
14/10.5	6.25	214	9.5	2.8	8.4	1.4	3.2	13.3	28.6	16.2	13.2	0.0
15/13.3	6.75	120	13.0	4.1	5.0	1.6	6.5	27.9	64.8	11.8	12.5	0.1
15/8.8	7.25	116	11.8	3.2	9.3	9.4	0.4	24.8	72.1	7.5	14.7	--
15/8.8	7.05	74	7.8	1.5	3.6	1.6	0.8	22.3	40.8	0.8	7.5	0.1
16/14.1	6.70	134	15.0	4.0	5.1	1.4	9.0	34.7	66.7	9.5	12.8	0.1
23/11.6	6.99	74	4.9	2.8	5.8	1.3	20.9	12.8	51.2	11.9	5.1	0.1
24/12.8	6.60	123	7.6	3.5	6.3	1.4	14.6	13.7	35.8	20.3	31.1	0.1
24/10.5	6.55	139	6.6	3.5	6.6	1.7	8.4	13.9	29.9	16.2	13.7	0.1
24/7.8	7.00	86	7.8	2.9	6.6	3.7	2.0	14.1	29.9	13.0	12.2	0.1
33/8.8	5.90	266	18.0	5.8	9.5	1.9	10.2	17.1	27.2	59.0	16.9	0.1
33/4.0	6.95	15	10.4	3.5	2.7	2.0	7.6	19.6	34.5	5.7	1.3	0.1
34/9.5	6.59	191	6.5	2.1	7.3	1.3	6.0	18.4	32.2	16.8	11.3	0.2
34/6.6	6.28	194	4.4	1.7	2.4	0.8	6.9	18.2	32.2	5.7	1.3	0.1
36/9.0	7.70	-104	10.2	3.4	9.4	2.3	2.9	10.1	66.2	6.9	4.5	0.7
37/11.0	6.93	169	7.6	3.3	10.6	1.9	3.4	37.2	51.7	5.5	3.4	0.3
Lake 233	--	--	4.2	1.6	21.3	0.6	0.2	--	3.9	41.2	3.1	0.0

Table 1.3. Anthropogenic organics from Area C plume in units of $\mu\text{g/L}$

Organic Compound	C-112 (11 m to 12.5 m)	C-212 (10 m)
1,1-Dichloroethane	32.0	55.9
1,2-Dichloroethane	4.0	7.4
Carbon Tetrachloride	4.6	1.2
Chloroform	39.4	6.0
Tetrachloroethene	4.4	1.2
Trichloroethene	409.0	182.0
trans-1,2-Dichloroethene	1.4	257.0
Benzene	1.7	-
o-Xylene	-	1.6
Naphthalene	-	16.5
Bis(2-ethylhexyl)phthalate	3.5	9.0

Table 1.4 Carbon and ^{14}C concentrations in Area C waters. Refer to Figure 1.8 for well locations.

Well No.	Carbon Concentration		^{14}C Concentration		Specific Activity	
	DIC (mg/L)	DOC (mg/L)	DIC (nCi/L)	DOC (nCi/L)	DIC (nCi/gC)	DOC (nCi/gC)
104	13.82	0.83	1.1	0.1	78.9	147.2
105	12.10	2.45	2.8	0.7	232.5	294.1
112	46.65	19.76	7.0	1.0	150.3	50.5
114	44.47	7.84	4.6	0.9	103.1	111.5
211	37.78	24.7	5.5	3.3	5390	134.7
212	38.10	7.25	2.9	0.0	76.7	6.1
213	52.96	9.12	28.6	0.7	540.5	78.0
214	29.86	7.78	8.7	0.8	290.2	97.6
216	23.22	5.29	8.3	0.1	358.5	22.9
221	30.58	5.58	1.6	0.1	52.5	14.1
222	55.30	21.6	1.9	0.3	34.6	11.4
Duke Stream	7.66	3.57	0.1	0.0	17.9	4.5
Bulk Storage Stream	7.77	1.97	0.1	0.3	9.3	159.1

2 Experimental

The general intent of the experimental phase was to identify and quantify as many of the mobile radionuclide species as practical. This process is inherently difficult due to the invariably low radionuclide concentrations, the potential instability of the complexed species, the nature of their kinematics, changing physico-chemical conditions in the spatial and temporal domains, etc. Toward this end, a number of diverse procedures and methodologies were used to study the speciation of migrating radionuclides: 1) field sampling of groundwaters and subsurface sands, 2) radioanalytical techniques, 3) wet chemistry, 4) ion exchange, 5) hollow-fiber and membrane ultrafiltration, 6) ion-exchange chromatography, and 7) liquid chromatography.

2.1 Observation Wells

Wells were drilled at Area C and the Chemical Pit using a rotary drilling rig. When soil sampling and multi-level piezometer installation were the objectives of the borehole, 9.5-cm-ID hollow-stem augers were used. When installing the groundwater sampling wells, 15.2-cm-ID hollow-stem augers were employed. Portable equipment was deployed in the wetland down-gradient of the Chemical Pit, and a gas-powered jackhammer for driving the flush-joint casing was used. While drilling, the casings were flushed with water at a flow rate of approximately 50 L/min.

Cores of soil were collected with a fixed-piston sampler fitted with thin-wall, 5-cm-ID aluminum tubing. Core lengths were either 0.76 m or 1.52 m, and the soil samples were collected ahead of the advancing borehole. Cores were checked for beta and gamma activities as they were retrieved, logged for visual features, and subsampled. These subsamples (except for soils collected from well CP-4B) were subsequently oven dried and archived. Following a second screen for beta and gamma activities in the dried

samples, composites from the contaminated portions of CP-4, ES-39, and ES-16 were prepared. Individual samples were subdivided using a mechanical splitter, and appropriate quantities of these subsamples were combined.

Sampling wells used to collect groundwaters for speciation analyses were installed at borehole locations CP-4, ES-39, C-112, and C-213 at depths selected to correspond with the maximum concentrations of radionuclides as defined by previous soil cores, borehole gamma scans, and groundwater samples from multilevel piezometers. The wells are constructed of 10-cm-ID, 1-m-long, stainless-steel well screens (0.15-mm slot width) attached to 10-cm-ID stainless-steel pipe that extends about 1 m above the water table. The remainder of the well casing consists of 10-cm-ID Schedule 40 PVC pipe. The local sands, which have no cohesive strength below the water table, slumped around the well screens as soon as the augers were withdrawn. Above the water table, the annular space around the well casing was backfilled with clean local sand, and a 0.6-m seal of powdered bentonite was installed just below grade. The well at ES-16 consists of a 7.6-cm-ID, 0.91-m-long stainless-steel screen with a 7.6-cm-ID Schedule 40 PVC casing to the surface.

2.2 Groundwater Sampling and Analyses

2.2.1 Sampling

All of the sampling wells were developed after installation. Initially, the wells were pumped to dryness repeatedly (with the exception of C-112, which sustained pumping at a rate of 40 L/min) and then pumped for a minimum of 1 hour at a sustainable rate (>12 L/min) within 5 days of sample collection. A 4.6-cm-OD stainless-steel, variable-speed, submersible pump or a bellows-type metering pump with polypropylene wetted parts was used for drawing groundwater samples.

All water samples were collected after removing at least three column volumes of water or after pumping the well to dryness twice. Sample flow rates were maintained as low as possible to preclude resuspension of any microparticulates retained by the aquifer medium (generally less than 100 mL/min). During this process, groundwater

temperature, pH and Eh, dissolved oxygen, alkalinity, and $\text{Fe}^{2+}/\text{Fe}^{3+}$ ratios were determined. Aliquots were also drawn for analyses of trace metals (inductively-coupled plasma/atomic-emission spectrometry), anions (ion chromatography), and organic carbon content (persulfate/ultraviolet-oxidation analysis). Samples were pressure filtered through sterile 0.2 μm or 0.45- μm membranes at the wellhead or suction-filtered through 0.45- μm membranes in a CRL laboratory within 4 hours of sample collection. The purpose of this prefiltration step was to retain any undissolved or particulate matter. Waters were maintained on ice during transit and storage to hinder kinematic processes and mitigate against any physico-chemical changes to the dissolved species.

A number of in-line prefiltered groundwaters were passed through a large-volume water sampler (Robertson and Perkins 1975) to facilitate the removal of charged and uncharged soluble species. Generally, about 200 L of groundwater were sampled at each well through this system. This modular unit is composed of six stacked resin or sorbent chambers (2.5 cm thick by 20 cm in diameter) separated by glass-fiber filter sheets. Water enters the base of the unit and is directed to the first of two cation-exchange resin beds (Na^+ form, 200-400 mesh), the redundant bed being present in case the first becomes compromised or saturated with ions. This resin was originally in the H^+ form, but was converted to the Na^+ form to eliminate the potentially destructive or denaturing effects on existing radionuclide species that might have been caused by the resulting acidic solution. Following the cation beds are duplicate layers of anion-exchange resin (Cl^- form, 200-400 mesh) for the retention of negatively charged species. Finally, a pair of activated aluminum-oxide sorbent beds are used to remove those radionuclides that exist in soluble, non-ionic forms.

2.2.2 Radiometric Analyses

Following this ion-exchange groundwater-sampling procedure, the individual resin and sorbent beds (as well as the prefilters) were rinsed with about 1 L of clean groundwater, de-watered, disassembled, and packaged for

shipment and radiological characterization. Gamma-ray spectrometry was performed by placing the prefilters (or their component membranes), resins, and sorbent powders in standardized geometries and counting them with lithium-drifted or intrinsic germanium detectors for suitable periods of time. Aliquots of the above materials were then leached with appropriate acid mixtures, and the resulting solutions were subjected to various radiochemical separation procedures for quantifying radioisotopes that were not amenable to direct gamma-ray analyses.

2.3 Ultra-filtration Experiments

A series of ultra-filtration separations were conducted on groundwater samples collected down-gradient from the Chemical Pit to determine the size distribution and the radionuclide association of colloidal-sized particles present in the groundwater at this site.

2.3.1 Colloid Sampling and Analysis

Samples of groundwater were collected from CP4, ES39 and ES16 (Figures 1.3 and 1.4) during the period August 9-11, 1993. The wells were located along a flowline from the pit to the nearby wetland. Well CP4 was just outside the fence around the pit, while ES16 was down in the wetland and ES39 was in between. Low sampling flow rates (0.25 to 1 L/min) were used to minimize resuspension of sediments in the boreholes during sampling.

In order to collect enough material for colloid characterization, Millipore tangential-flow ultra-filtration systems were used to produce particle concentrates (2 to 6 L) from 100 L groundwater samples. These concentrates contained enough material for colloid concentration and size analysis. Chemical and radiochemical analysis of particle concentrates and filtered water provided information on the association of various elements and radionuclides with colloids and suspended particles. The groundwater was not pre-filtered before ultra-filtration to avoid loss of colloids and suspended particles on the pre-filter. The filtration scheme is shown in Figure 2.1. In the first step particles larger than about 10 nm were concentrated by filtering groundwater through a Pellicon system equipped with 100,000 nominal molecular weight limit (NMWL) polysulfone membrane packets, separated by retentate

screens. The concentrate (retentate) produced by the 100,000 NMWL filter was filtered with a Minitan tangential flow filtration system (Millipore) equipped with a 450-nm cutoff Durapore membrane. This produced a filtrate containing colloids between 10 and 450 nm, and a concentrate enriched in suspended particles >450 nm. About twenty liters of filtrate produced by the initial 100,000-NMWL filtration were filtered through another Pellicon system, equipped with a 10,000-NMWL polysulfone filter cassette. This produced a sample of filtered water containing only dissolved species, and a concentrate enriched in colloids with a size range between 10,000 NMWL (~1 nm) and 100,000 NMWL (~10 nm).

Particle concentrations and size distributions were measured by pressure-filtering 25 mL of particle concentrates through a series of 25-mm Nuclepore polycarbonate filters with cutoff sizes of 10,000, 5000, 1000, 400, 100, 50 and 15 nm. Particle concentrations were determined by the weight of material deposited on the filters. The presence of colloidal material in the 1- to 10-nm size range was determined by comparing the chemical composition of colloid concentrates with that of filtered water. Particle size analysis was also carried out with an Ultrafine Particle Size Analyzer (UPA-Leeds and Northrup), which used backscattered laser light to measure the Brownian motion of particles with sizes between 6 nm and 2.5 μ m. Brownian motion was used to calculate particle size distributions.

A portion of filtrate with size < 10,000 NMWL from each sample was retained for speciation by anion exchange. These were kept covered in a coldroom until the separations could be performed.

2.3.2 Anion Exchange Chromatography of Ultra-Filtered Groundwater

To further characterize the ultra-filtered groundwater, anion exchange chromatographic separations were conducted on the 10,000 NMWL fraction to help identify the physicochemical speciation of the radionuclides.

An Alcott model 760 pump was used to load the samples and chromatographically separate the species. A Scanivalve rotary valve (model KEM5 12) was used to select the various eluent solutions, which were stored in 4 L polyethylene bottles. Salt gradients were generated using a Milton-Roy model 196-0066-003 piston pump and an acrylic mixing chamber on a magnetic stirrer. The conductivity of the eluent solutions was monitored downstream of the Alcott pump with a conductivity flow cell and meter salvaged from a Dionex ion chromatograph. The output signal from the conductivity meter was recorded with a UNEAR model 0142-0000 strip chart recorder. A 10 m length of Teflon capillary tubing (0.020 inch I.D.) between the Alcott pump and the conductivity cell provided back-pressure for the pump.

Chromatographic columns were constructed from 0.25 inch I.D. polyethylene tubing and 3/8 inch stainless steel Swagelok fittings, which were adapted to chromatography fittings. The columns were slurry packed and flow conditioned at 10 mL/minute prior to use. Further details of the columns and eluents are given in Table 2.1. Gamma-emitting radionuclides in the effluent from the analytical column were monitored online with a custom-built flow cell and a 7.6 cm by 7.6 cm well-type NaI detector (Harshaw). The gamma-ray spectra from the detector were recorded with a Davidson model 1056C multichannel analyzer (MCA) and the data from regions of interest in the spectra were transferred to a personal computer and printed out. The on-line flow cell provided qualitative results which were only used to monitor the elution of ⁶⁰Co during the runs. Fractions of effluent (nominally 6 mL) were collected with an LKB model 2070 ULTRORAC II programmable fraction collector. A signal from the fraction collector was used to control the MCA which read out the data and started a new accumulation at each change to a new fraction. Teflon tubing was used for all of the interconnections in the system.

Figure 2.1 Water filtration scheme for ultra-filtration and chromatography studies

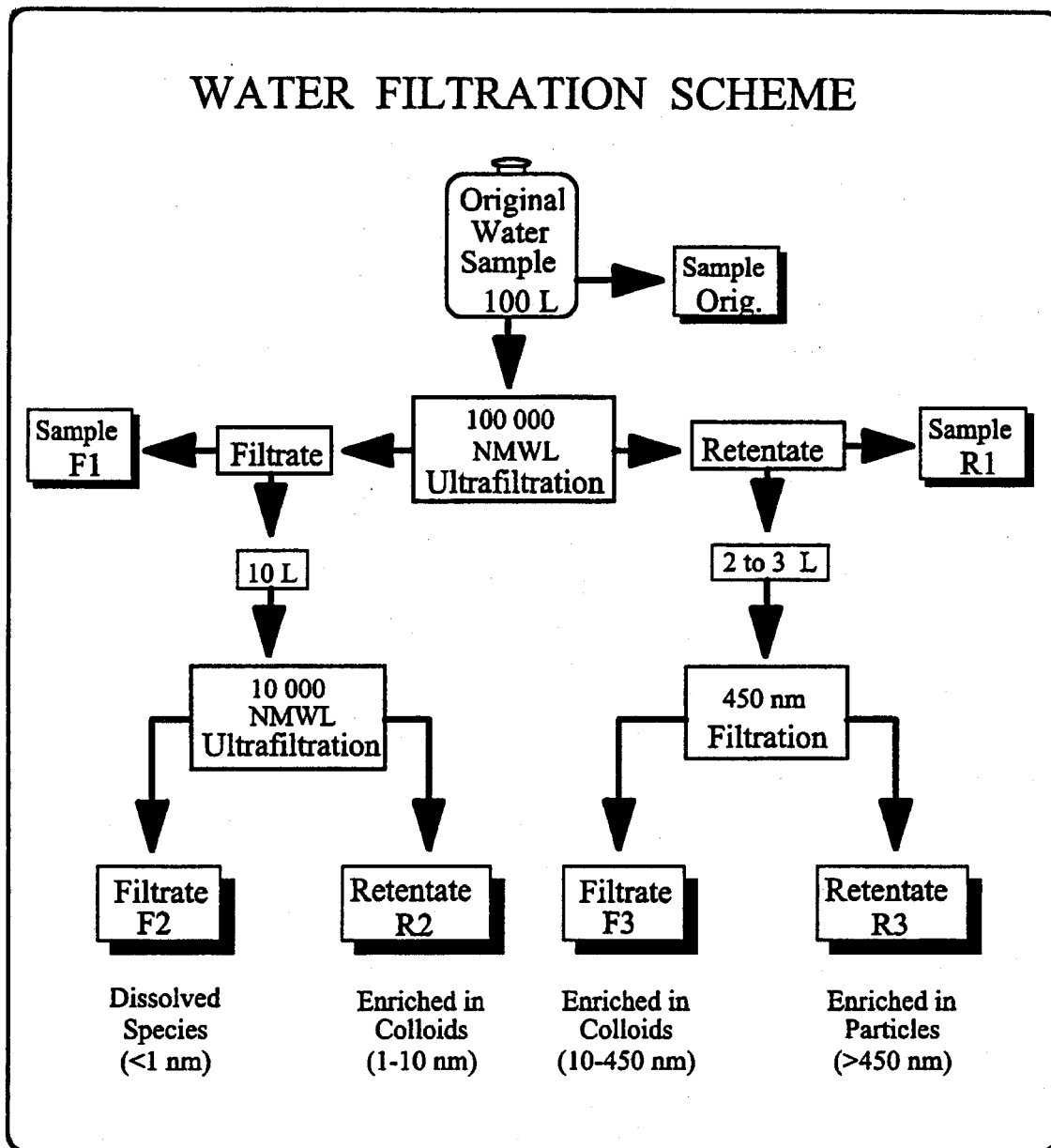

Table 2.1 Experimental conditions for AG MP-1 anion exchange chromatography separations of ultra-filtered groundwater

Resin Mesh Size	200 - 400
Pre-Column Length	7 cm
Analytical Column Length	25 cm
Nominal Flow Rate	6 mL/min
Sample Volume	3 to ~6 L
Eluents:	
pH 4.5 HCl	30 mL
0-0.5 M KCl gradient	500 mL
0.5 M KCl	375 mL
0.1 M HCl	200 mL

The general procedure for the separations using AG MP-1 resin was to transfer a portion of sample to an opaque container, weigh it and load it onto the columns overnight. The sample container was re-weighed after loading to determine the amount loaded and the flow rate. The elutions with pH 4.5 HCl (i.e.

double distilled water adjusted to pH 4.5 with HCl), 0 to 0.5 M KCl gradient, 0.5 M KCl and 0.1 M HCl were carried out the next day. Each elution took most of a working day. The samples and eluents were degassed before each run by sparging with He gas for about 5 minutes.

2.3.3 Radionuclide Analysis of Ultra-Filtered Groundwater

Gamma-ray spectrometry was used to identify the radionuclides present in the effluent fractions from the anion chromatographic separations.

Quantitative results for ^{60}Co and ^{106}Ru were obtained by counting the fractions in 7 mL scintillation vials with a Packard MINAXI9 automatic gamma counter. Selected

samples were analysed on a gamma-ray spectrometer consisting of a 30% EG&G Ge detector and ND 6700 analyzer. Larger liquid samples were either counted in a 400 g geometry in a polyethylene bottle or dried on polyethylene film and pressed into plastic pillboxes. Alpha spectrometry was performed with Nucleus model 5300 or EG&G Ortec model 676 alpha spectrometers connected to an EG&G model 920-16 multichannel buffer. The counters and spectrometers were calibrated with standards traceable to NIST.

Actinide isotopes present in selected fractions were radiochemically separated as a group. The fractions were transferred to glass beakers and 10 mL of nitric acid and 1 mL of 5% NaHSO_4 solution were added. The fractions were then evaporated to dryness and taken up in 1 M HCl (10-15 mL). The solutions were transferred to polypropylene centrifuge tubes. One mL of Nd carrier solution (100 μg of Nd/mL) was added prior to reducing the actinides with TiCl_3 (30% solution). Then the actinides were co-precipitated on NdF_3 by adding concentrated HF and sources were prepared by filtering through NdF_3 beds supported on 0.1 μm membrane filters (Gelman Supor®). The

filters were dried prior to analysis by alpha spectrometry.

Total actinide sources were also prepared from the filtrates and retentates obtained after ultra-filtration. Approximately 500 mL of each sample were acidified with about 50 mL of concentrated nitric acid. One mL of 5% NaHSO₄ solution was added to each and then they were boiled down to about 20 mL. Each sample was then diluted to about 200 mL and 10 mg of Fe⁺³ carrier was added. Ferric hydroxide was precipitated by raising the pH to about 9 with NH₄OH. The ferric hydroxide was then dissolved in a minimum volume of concentrated HCl and the volume was made up to 10 to 15 mL with 1 M HCl. Actinide sources were then prepared by co-precipitation on NdF₃ in the same manner as described above for the fractions.

2.4 Laboratory Chromatography Experiments

A series of laboratory anion chromatography experiments using 0.45 μ m filtered groundwater from well ES16 were conducted to separate and identify individual physicochemical forms of the migrating radionuclides present in anionic forms.

2.4.1 Field Sampling

The samples were pumped from well ES16 (see Fig. 1.3) with a peristaltic pump and filtered off-line through a 0.45 μ m membrane filter. The filtered groundwater was collected in 20-L polyethylene carboys, which were covered to exclude light and stored in a coldroom until the experiments were performed. Generally, the first experiment with a given sample was started on the day of collection or on the following day. Subsequent experiments with each sample were performed over periods ranging up to several weeks.

2.4.2 Chromatographic Equipment

The chromatographic equipment and methodology for ion exchange chromatography is similar to that described in Section 2.3.2 and is shown schematically in Figure 2.2. The Alcott model 760 microprocessor controlled dual piston pump was programmed to pump at 3 mL/min. A Scanivalve rotary valve (model KEM5 12) was used to connect the inlet of the pump to various eluent solutions, which were stored in 4-L polyethylene bottles, and to the gradient programmer. Salt gradients were generated with an ISCO model 2360 gradient programmer.

This programmer can generate ternary gradients and it was used to produce both KCl and HCl gradients. The conductivity of the eluent solutions was monitored downstream of the Alcott pump with a conductivity flow cell and meter from a Dionex ion chromatograph. The output signal from the conductivity meter was connected to one of the detector inputs on a Dionex Advanced Computer Interface, which was used to record data and to control the Scanivalve and gradient programmer. A 10-m length of Teflon[®] capillary tubing (0.020 inch I.D.) between the Alcott pump and the conductivity cell provided back-pressure for the pump. Online UV measurements at 254 nm were made with a Shimadzu model SPD-10A UV detector. The signal from the UV detector was connected to the second detector input on the Advanced Computer Interface.

Figure 2.2 Chromatography equipment used for anion separations of organo-radionuclide species

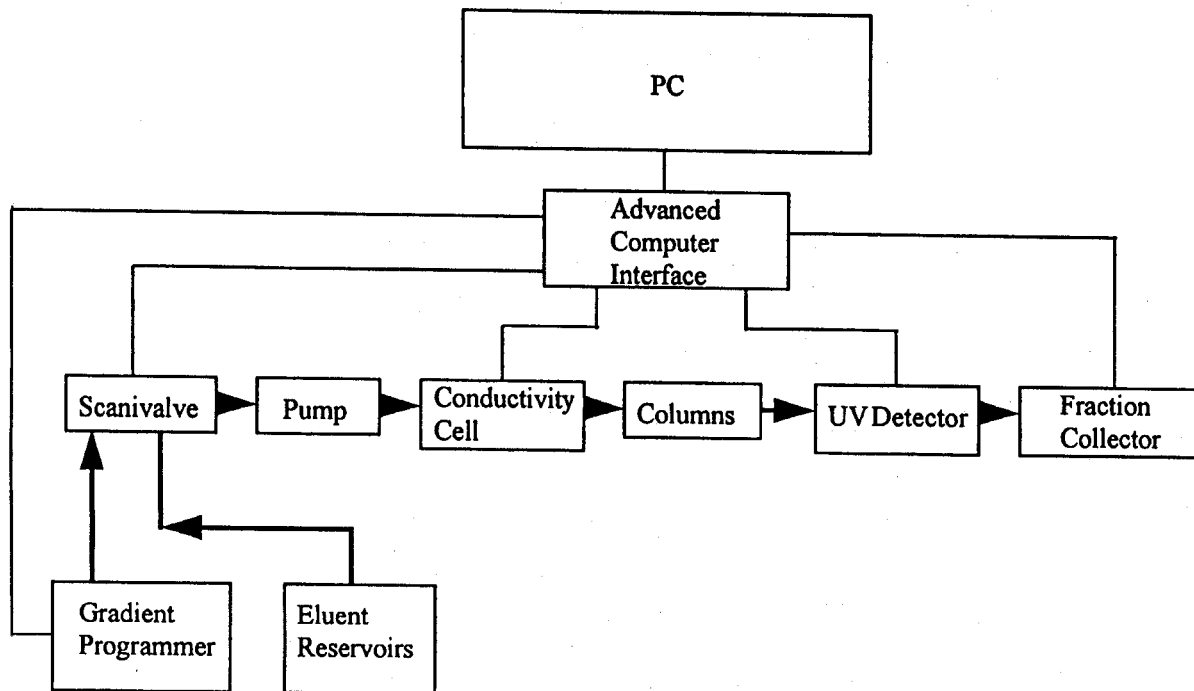

The Advanced Computer Interface was connected to a PC and controlled with Dionex software (AI-450). Fractions of effluent (6 mL) were collected with an LKB Model 2070 ULTRORAC II programmable fraction collector, which was programmed to collect fractions for 2 minutes.

Chromatographic columns were constructed from 0.25 inch I.D. polyethylene tubing and chromatography fittings from spent Dionex columns. Porous polyethylene frits were used to retain the resin at the ends of the columns. Teflon tubing was used for all of the interconnections in the system.

2.4.3 Preparation of AG MP-1 Columns

The procedure used to prepare the guard (7 cm) and separation (25 cm) columns is given in Appendix 1. After preparation, the columns

were connected to the rest of the system and covered with aluminum foil to exclude light.

The columns were kept dark because previous studies (Killey et al., 1984) had shown that some complexes were light sensitive.

2.4.4 Procedure for Loading and Eluting AG MP-1 Columns

The procedure used to load the samples onto the columns and elute the species is given in Appendix 2. Two separate elution runs were conducted, an initial run on May 7, 1996, and a second run on May 15, 1996. A slight modification of this procedure was used for the run on May 7, when the 0.1 M HCl elution was terminated after only 50 minutes.

2.4.5 Radionuclide Analysis

Cobalt-60 in the column effluent fractions was measured in 7 mL scintillation vials with a Packard MINAXI automatic gamma counter. The ^{60}Co results were normalized to the weight of groundwater loaded onto the columns. Selected samples from the May 15 run were analysed on a gamma-ray spectrometer consisting of a 20% Canberra Ge detector connected to a Canberra Series 10 analyzer. Since quantitative results were not needed for the chromatographs, no detector calibrations were applied. The analyses on the Ge detector provided data for ^{137}Cs and better counting statistics for ^{60}Co .

2.4.6 Measurement of UV Spectra

The UV absorbance spectra of selected fractions from the May 7 run were obtained off-line with the UV detector. Fractions were selected on the basis of peaks observed at 254 nm in the UV chromatograms.

Samples from the fractions were manually loaded into the UV cell with a syringe. The detector was then set to scan mode and the absorbance was recorded by the PC through the Advanced Computer Interface.

2.5 Laboratory K_d Experiments with Anionic and Cationic Radionuclide Species

Subsurface contaminant transport from buried wastes is an environmental problem that faces many sites. In the nuclear industry, the primary contaminants of concern are radioisotopes, and due to the nature of the contaminants and the soils, some are quite mobile (i.e., tritiated water), but many exhibit various degrees of retention in soils. Contaminant transport models used to determine the fate of the radionuclides in the environment, when licensing is sought for nuclear waste management facilities, frequently simulate the retardation of contaminants in soils using the solid-liquid partition coefficient K_d . It is generally defined as:

$$K_d = \frac{C_{\text{solid}}}{C_{\text{liquid}}} \quad (1)$$

where:

K_d = solid-liquid partition coefficient (volume/weight)

C_{solid} = concentration of contaminant sorbed on the solid at equilibrium (amount/weight of solid)

C_{liquid} = concentration of contaminant left in solution at equilibrium (amount/volume of solution).

Solid-liquid partition coefficients are lumped parameters that may include several processes, such as sorption onto a variety of binding sites, or the influences of aqueous speciation, into one single value. Many of the K_d 's in the databases that are frequently referenced in transport simulation models (e.g., Sheppard and Thibault, 1990; Caron, 1995), are derived from laboratory experiments that may not completely

represent conditions and reactions that take place in field settings. Contaminant plumes that have been present in actual flow systems have long been of interest as case studies, where the adequacy of the K_d model can be tested. The simple groundwater flow system adjacent to the Chemical Pit used for low-level aqueous radioactive wastes at the Chalk River Laboratories (CRL) has been a valuable field site for conducting geochemical investigations.

Studies of this site (Cooper and McHugh, 1983; Killey et al., 1984; Champ and Robertson, 1986; Cooper and Mattie, 1993; Robertson, et al., 1995; Schilk et al., 1996), have found that several radionuclides that would be expected to exist as cationic species sorbing strongly to aquifer sediments have formed stable, mobile complexes. Similar phenomena, leading to transport of actinides over distances of several kilometres, were reported by Penrose et al. [1990]. Such observations raise obvious questions about the validity of the laboratory-derived K_d 's that are used in predictive models.

The objectives of this task were to: 1) determine K_d values of radionuclides in the aquifer down-gradient of the previously mentioned infiltration pit at CRL as a function of their field chemical speciation, and 2) to compare these measurements with those obtained by the conventional laboratory approach of "batch" K_d determination using a tracer of the same element. In this manner, more realistic K_d values for the mobile anionic species of several important radionuclides were determined. These values could then be used by transport modelers to more accurately predict "first arrival times" of the migrating radionuclides.

2.5.1 Soil and Groundwater Sampling and Preparation for K_d Measurements

Samples of contaminated (ES-16) and uncontaminated (ES-9) groundwaters were collected at two locations in the vicinity of the Chemical Pit (Figures 1.3 and 1.4). The ASTM Method D 4319-83 (ASTM, 1984) was used to determine the solid-liquid partition

coefficient K_d . The solution-to-solid ratio was 4:1 (volume:weight basis). The radionuclides of interest were present in the contaminated ES16 groundwater (^{60}Co , ^{106}Ru , ^{137}Cs , Pu isotopes, ^{241}Am , ^{244}Cm), and these were used for the K_d measurements for the field chemical species. Commercially available tracers in known chemical forms were added to the solutions at specific points in the experimental sequence, as described in the following sections.

The calculation of the K_d using the above radionuclides was given by the relationship:

$$K_d = \frac{C_0 - C_{eq}}{C_{eq}} \times \frac{V}{M}$$

Where:

K_d = Liquid-solid partition coefficient (mL/g)

C = Concentration of element (Bq/L or equivalent); subscripts 0 and eq correspond to *initial* and *equilibrated*, respectively

V = Volume of solution (mL)

M = Mass of solid in contact with the solution (g).

Four sets of sorption experiments were conducted. In the first two, samples of ES16 contaminated groundwater were passed through columns of ion exchange resins to isolate the cationic and anionic species of radionuclides already present in solution. In the other two sets, one aliquot of untreated ES9 uncontaminated groundwater was used with added tracers to determine K_d values according to conventional methods. A second aliquot was processed by reverse osmosis to remove colloidal material, including large humic/fulvic acid (HFA) molecules, and some dissolved inorganic species, and then used to carry out the same type of batch K_d determination.

Uncontaminated sand collected from boreholes located outside the contaminated area (ES41, ES42, ES47, ES48; Figure 1.3), were used to make a composite soil sample. Approximately 4.2 kg of material (total) was

pre-conditioned in a 4-L plastic container with a sample of uncontaminated groundwater (from well ES9), for ~2 weeks at room temperature. After conditioning, the sand was air-dried on a filter paper. Four sub-samples were taken for particle-size distribution during the homogenization step, to ensure the homogeneity of the sample prior to subsampling for sorption studies. The size distribution was very similar between the replicates.

In June 1996, approximately 20 L and 40 L of groundwater were collected from ES-9 and ES-16, respectively, using a peristaltic pump and existing piezometers. Dark plastic garbage bags were used to cover the sample containers to avoid any possible speciation change induced by photolysis (Cooper and McHugh, 1983). The samples were filtered through 0.45 μm pore size polysulfone filter discs (Gelman, 15 cm dia.) within one week of collection. Throughout the program, waters were stored in the dark at 4 °C, and all sample manipulations were conducted under subdued light.

2.5.2 Isolation of Anionic and Cationic Radionuclide Fractions from Contaminated Groundwaters

Figure 2.3 shows the flowchart of sample manipulations to isolate the native anionic species of the radionuclides present in ES16 groundwater. Immediately after 0.45 μm filtration, a 1-L aliquot of the groundwater was reserved for total radionuclide content and for major ion analysis. Approximately 20 L of the filtered contaminated groundwater was passed through a bed of 800 mL of AG50-X8 cation exchange resin (100-200 mesh, Bio-Rad; previously converted to its Na^+ form and rinsed with deionized water), at a rate of 28 mL/min to remove the cationic species of nuclides, leaving only the anionic species in solution. The amount of resin was calculated to exceed the expected cationic content by a factor of 10-20 times. A ~1-L aliquot of the eluate was used for radionuclide analysis, and the rest of the solution was kept in the dark (at 4 °C) until the Kd measurements were

performed. The radionuclides left in solution were operationally defined henceforth as "anionic species".

A second 20-L aliquot of ES16 groundwater was passed through a bed of 500 mL of AG1-X8 anion exchange resin (100-200 mesh, obtained from Bio-Rad in its Cl⁻ form; the resin was rinsed with deionized water before using) to remove the anionic species and isolate the positively charged native cationic species present in the ES16 contaminated groundwater. The amount of resin was 10-20 times in excess of the expected anion exchange capacity, and a ~1-L aliquot of the eluate was also taken for radionuclide analysis. This fraction was henceforth called "cationic species", although it was recognized that neutral species would pass through both resins, and that there might be very small amounts of chemical retention of some complexes on either or both resins.

After elution through each resin, and after a resting period, each solution was split into two aliquots. The first aliquot was used for non-radiogenic analysis (major ions, etc.), whereas the second aliquot was spiked with tracers which are not present in the original samples (¹³⁴Cs, ⁵⁷Co, ⁹⁴Nb; see Table 2.1). Except for the addition of radionuclides, both aliquots were treated identically, including the equilibration times. The volume of solution used was 800 mL along with 200 g of sand.

2.5.3 Blanks, "Conventional Batch" Kd Measurements, and "Reverse Osmosis" Samples

In parallel with the above, a sample of uncontaminated groundwater from well ES9 was taken and split into three portions which were used for blanks, conventional "batch" Kd determinations, and "nanofiltered batch" Kd determinations.

Blanks were prepared by filtering the groundwater (Figure 2.4). A sub-sample was taken for total radionuclide analysis, and the remainder of the sample was split into two aliquots. One aliquot was passed through a column of cation exchange resin, while the other one was passed through a column of

anion exchange resin. After elution through each column, water samples for major ions and radionuclides were taken for analysis. The eluates were then contacted with the sand aliquots for 7 days, followed by radionuclide analysis of the aqueous sample. The second portion of the ES9 groundwater sample was treated identically to the scheme in Figure 2.3, except that the ion exchange steps were omitted. Commercial tracers (^{134}Cs , ^{57}Co , ^{94}Nb , $^{239/240}\text{Pu}$ and ^{241}Am) were added to the solutions (Table 2.2). The solution volumes were 200 mL, and were contacted with 50 g of sand. The equilibration time was also 7 days. This sample pre-treatment is henceforth referred to as "conventional batch" Kd measurements.

The third portion of the ES9 sample was filtered using a reverse osmosis unit (Osmonics Model 19E, with a 112-HR membrane, 200 nominal molecular weight cutoff - NMWCO), to remove colloidal-sized material, high molecular weight dissolved organics, and many dissolved ionic species. All other features, similar to the

"conventional batch" method, were used. This sample is referred to henceforth as "reverse osmosis" Kd measurements.

2.5.4 Speciation Checks for Soluble Radionuclides

The fundamental assumption behind this work was that the chemical species of the radionuclides of interest remain stable for the duration of the experiment. Radionuclide speciation, operationally defined as the relative proportion of negatively charged versus positively charged species, was checked at various points in the sample processing to determine if the speciation had changed with time or sample manipulation. The top part of the flowchart in Figure 2.4 constitutes the sample manipulation for a speciation check. The key steps during sample processing, where samples were taken for speciation checks, are indicated in Figure 2.3

Figure 2.3 Simplified flow chart of sample manipulation and analysis

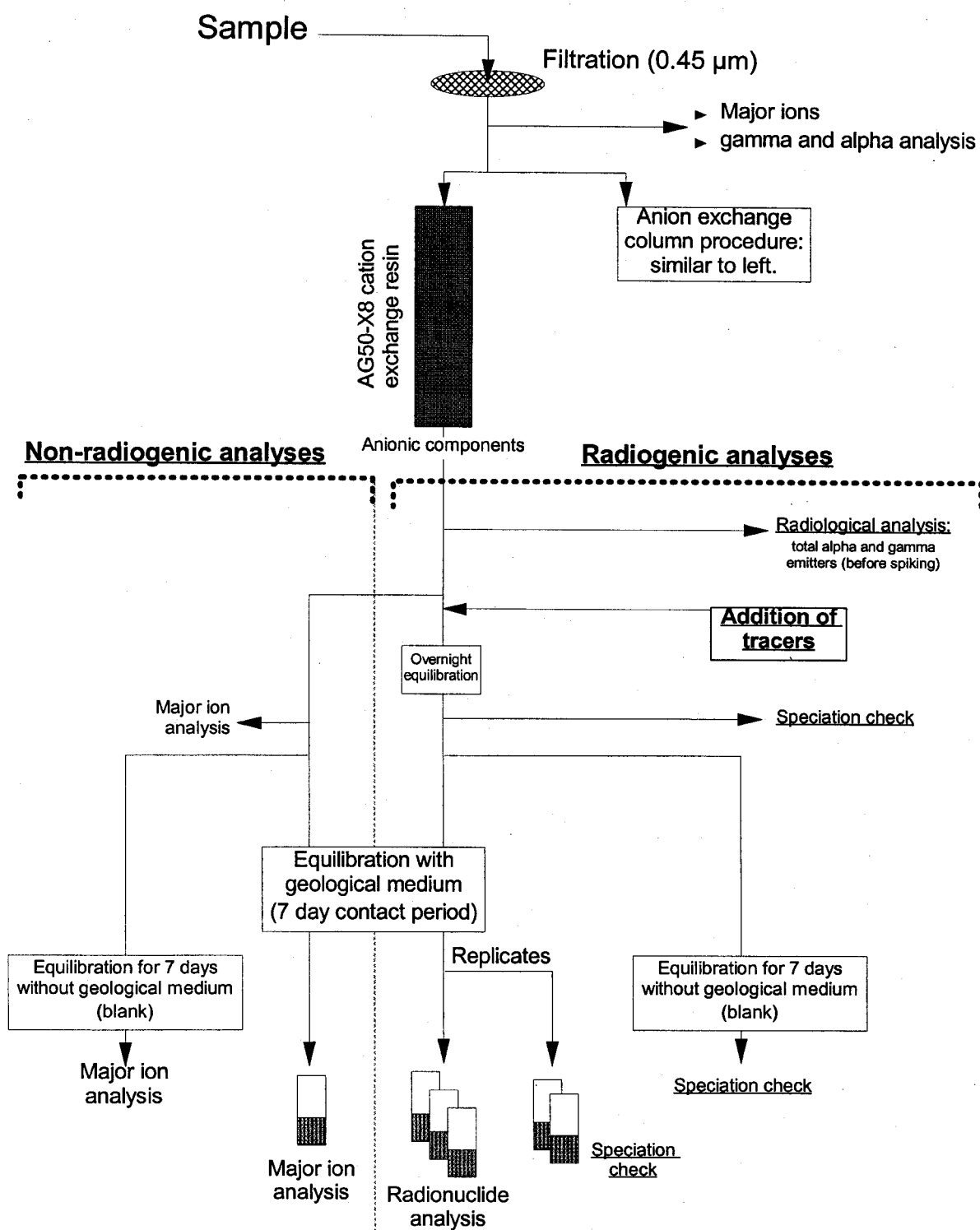

Table 2.2 Levels of radionuclides present in contaminated and uncontaminated groundwater (measured), and levels of artificial tracers added to each solution (calculated)

Radionuclide	ES16 contaminated groundwater (June 1996 sampling)			ES9 uncontaminated groundwater	
	Initial amount reported (pCi/L)	tracer added (pCi/L)	Detection limit (pCi/L)*	tracer added (pCi/L)	detection limit (pCi/L)**
Co-60	3080		~1.9		11-65
Ru-106	460		11-54		140-810
Cs-137	1050		4.0-8.0		11-95
Pu-238	38		~0.05		0.3
Pu-239	184		~0.05	1.02E4	0.3
Am-241	5.4		5-50 (γ) [†] ~0.05 (α) [‡]	9,530	35-110 (γ) [†] 0.3 (α) [‡]
Cm-244	0.54		~0.05		0.3
Artificial tracers					
Co-57	4.1	1.42E4	~2.7	5.3E4	~8
Nb-94		8,210	2.7-5.4	5.68E4	~11
Cs-134	2.9	8370	1.4-14	5.43E4	1.4-54

*Based on a 1 L sample and a 3 h count for the gamma emitters, and a 16 h count for the alphas.

**Based on a 0.2 L sample and a 3 h count for the gamma emitters, and a 6 h count for the alphas.

†Based on gamma spectrometry.

‡Based on alpha spectrometry

Figure 2.4 Flowchart showing the procedure for blanks (with uncontaminated groundwater) and for speciation checks (note: for speciation checks, major ion analysis is also omitted)

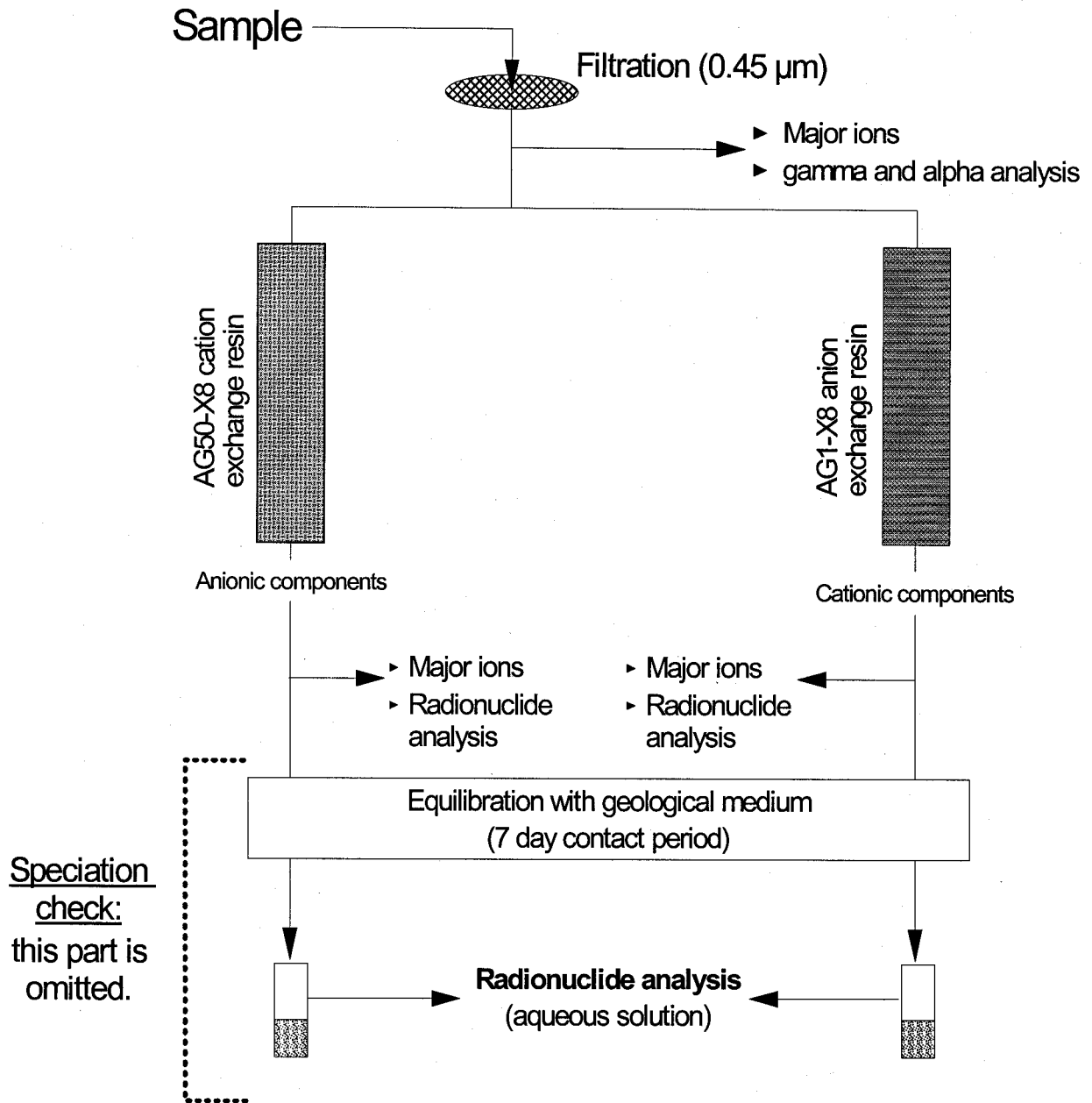

The initial speciation check for the ES16 groundwater used the original sample after filtration, whereas the "anionic" and "cationic" species were collected immediately at the outlet of their respective columns. An additional speciation check was done after the tracers were added, before equilibration with the sand. After equilibration with sand, the supernatant solution, used for total radioisotope content (C_{eq} in Eq. (2)), was also used as the "total" for the speciation check. Two of the replicates of equilibrated solution were saved for the "anionic" and "cationic" species determination.

Finally, two additional groundwater samples were taken from ES-9 and ES-16 approximately 5 months (November 1996) after the original sampling, to check for speciation changes in the solution alone (i.e., without being in contact with sand). The samples were treated identically as before (Sections 2.5.2 and 2.5.3), and spiked with the same quantities of radionuclides as before (Table 2.2). The equilibrations were done over a period of 7 days, which was the same as the contacting period for the initial K_d determinations.

2.5.5 Analyses of Soluble Groundwater Constituents

The cations were analyzed by ICP-AES, the anions by ion chromatography (HPLC, IonPac AS4A column, and AI-450 processing software, all from Dionex), and DIC + DOC by total carbon analyzer (Dohrmann DC-80). The pH was measured as soon as possible after each step or immediately before equilibration with geological material.

Each solution was prepared for radiochemical analysis by pouring the sample into a tray, double-lined with a polyethylene sheet, and evaporated to dryness under an infra-red lamp. The dried sample, in the polyethylene sheet, was folded and pressed with a hydraulic press to make a 4 cm diameter disc in a plastic petri dish. This sample was counted on a hyperpure Ge detector for 3 or 5 h. After counting, each disc was recovered for analysis of the alpha emitters. Approximately 0.1 Bq of yield tracer (^{236}Pu or ^{242}Pu) was added to

each disc, which was then ashed overnight at 450°C in a pyrex beaker. After this first ashing, ~0.5 g of NH_4NO_3 was added to the ashes in each beaker, to minimize problems with undesirable precipitates in the sample re-dissolution in the subsequent steps. After this addition, the residue was ashed again at 450°C for at least 6 hours. A procedure similar to the method of Rao and Cooper [1995] was used to prepare NdF_3 co-precipitated actinide sources. The samples from ES-16 were all processed to separate the Am + Cm fraction from the Pu + Np fractions, whereas the sources from the samples from ES-9 (uncontaminated groundwater) were prepared for total actinide analysis. All the samples were counted on 9 different alpha spectrometers, individually calibrated for 7 hours (ES-9 samples) or 16 hours (ES-16 samples).

2.5.6 Addition of Spikes for K_d Measurements

The ES16 groundwater contained various levels of ^{60}Co , ^{106}Ru , ^{137}Cs , $^{239/240}\text{Pu}$ and ^{241}Am (Table 2.2). Tracers that were not present in the groundwater (^{57}Co , ^{94}Nb , ^{134}Cs), were added after ion exchange processing to compare their K_d values to those of the contaminants already present in the plume. The same tracers, plus ^{241}Am and $^{239/240}\text{Pu}$, were added to the ES-9 uncontaminated groundwater to compare the results of the K_d after ion exchange processing to that of a typical "classical" batch K_d .

The tracers were obtained either commercially (^{57}Co , from Amersham Canada) or from General Chemistry Branch at CRL (^{94}Nb , ^{134}Cs , ^{241}Am , ^{242}Pu , $^{239/240}\text{Pu}$). The Pu used in the sorption experiment was adjusted to its +IV oxidation state with NaNO_2 . All tracers came in strong acidic solutions (HCl, HF and/or HNO_3), and dilutions had to be made, in some cases, prior to addition to the final solutions. Small volumes of spikes were used, which translated into no significant drop in pH and small additions of Na^+ , Cl^- , F^- and NO_3^- ions (Tables 2.3 and 2.4).

Table 2.3 Concentrations of major ions in ES-16 contaminated groundwater at various stages of sample processing

Ion	Concentration increase after tracer addition	ES-16 contaminated groundwater composition (all concentrations in mg/L)						
		Original filtered groundwater	After cation exchange resin step			After anion exchange resin step		
			Column Eluent	before equilibration	after equilibration	column eluent	before equilibration	after equilibration
Ca ²⁺		1.72	ND	0.60	0.58	1.72	1.73	3.60
Fe ³⁺		1.56	0.58	0.35	0.07	ND	ND	ND
K ⁺		1.40	0.50	0.30	1.20	1.70	1.70	2.50
Mg ²⁺		0.72	ND	ND	0.16	0.74	0.72	1.00
Na ⁺		6.80	13.90	13.60	13.60	6.70	6.80	9.00
Si		5.80	5.70	5.70	6.20	5.60	5.70	6.70
F ⁻	0.01	0.28	0.31	0.29	0.35	0.05	0.06	0.10
Cl ⁻	0.1	1.25	1.32	1.32	3.12	24.95	24.15	26.01
NO ₃ ⁻	0.4	0.26	0.48	0.10	0.35	ND	ND	0.15
SO ₄ ²⁻		8.46	8.72	8.77	14.80	ND	ND	4.48
DIC (as C)		5.09	5.07	3.90	1.98	0.09	0.07	0.27
DOC (as C)		4.17	3.49	4.03	5.03	9.80	9.67	10.47
pH	7.31† 4.14‡	6.28	6.80	6.88	7.34	4.13	4.19	5.97

†To be compared to eluent from the cation exchange resin step.

‡To be compared to eluent from the anion exchange resin step.

Table 2.4 Concentrations of major ions in ES-9 uncontaminated groundwater at various stages of sample processing

		ES-9 uncontaminated groundwater composition (all concentrations in mg/L)								
Ion	Conc. increase after tracer addition	Ion exchange processing (for blanks purposes)			K _d determination "conventional batch" method			K _d determination, after reverse osmosis processing "nanofiltered batch" method		
		Original filtered	after cation exchange	after anion exchange	Original filtered	before contact	after contact	Original nanofiltered	before contact	after contact
Ca ²⁺		4.90	0.09	4.80	4.80	4.80	3.30	0.75	0.99	1.49
Fe ³⁺		2.00	1.77	0.01	1.89	1.74	0.07	0.02	0.03	0.01
K ⁺		1.90	0.35	1.40	1.50	1.30	1.90	0.60	1.30	1.50
Mg ²⁺		1.88	ND	1.86	1.90	1.88	1.06	0.46	0.52	0.44
Na ⁺	0.1	2.12	12.50	2.04	2.04	2.00	4.50	1.18	1.38	5.50
Si		7.40	6.40	7.20	7.70	7.70	8.00	4.50	4.30	5.40
F ⁻	0.1	0.08	0.09	0.07	0.09	0.07	0.16	0.06	0.08	0.11
Cl ⁻	2.1	1.43	1.24	26.31	1.13	1.23	2.68	0.73	0.86	4.66
NO ₃ ⁻	3.3	0.08	0.10	ND	0.06	ND	0.13	0.12	0.08	3.41
SO ₄ ²⁻		10.39	8.97	ND	10.42	10.39	14.89	2.95	2.89	8.28
DIC (as C)		3.28	3.09	0.27	2.77	4.33	1.30	0.74	0.47	0.16
DOC (as C)		5.32	5.51	17.60	4.84	3.11	3.38	1.74	1.40	1.57
pH	6.85† 6.69‡	6.88	7.52	4.22	6.79	6.89	7.02	6.10	6.45	6.49

†To be compared to "batch K_d determination, before contact".

‡To be compared to "nanofiltered batch, before contact".

3 Results and Discussion

3.1 Concentrations and Chemical Speciation in Groundwater

The results of the large-volume water sampling conducted down-gradient from the Chemical Pit between 1983 and 1994 for partitioning radionuclides between particulate, cationic, anionic, and non-ionic species are shown in Figures 3.1 to 3.4. Total concentrations of ^{60}Co , ^{106}Ru , ^{125}Sb , and $^{239,240}\text{Pu}$ decreased significantly between 1983 and 1993-94. However, the relative distribution of these radionuclides between the various anionic, cationic, and non-ionic chemical forms remained relatively constant over this eleven year time frame. This indicated that the formation mechanism(s) of the more abundant mobile anionic species of these radionuclides has apparently not changed appreciably over the past ten or more years. Even though major changes in the quantity and composition of liquid discharges to the Chemical Pit occurred over this time period, they apparently did not have a major impact on the chemical speciation of radionuclides migrating from this site.

Anionic chemical speciation was the predominant charge-form observed for ^{60}Co , ^{106}Ru , ^{125}Sb , and $^{239,240}\text{Pu}$ during their transport in the groundwater down-gradient from the Chemical Pit. An earlier study (Champ et al., 1985) of the Chemical Pit contaminant plume also showed, that in addition to the above group of radionuclides, anionic species of ^{55}Fe , ^{63}Ni , $^{95}\text{Zr-Nb}$, and ^{137}Cs were the dominant chemical forms being transported in the groundwater. This was not too surprising for the $^{95}\text{Zr-Nb}$, ^{106}Ru , ^{125}Sb , and $^{239,240}\text{Pu}$, where thermodynamic calculations show anionic species to be predominant in oxygenated groundwater systems.

However, the predominantly anionic species of ^{55}Fe , ^{60}Co , ^{63}Ni , and ^{137}Cs observed in this groundwater were unusual, since thermodynamic calculations generally indicate that cationic species should predominate.

There is strong evidence to indicate that the negatively charged radionuclide species are primarily organo-radionuclide complexes formed with either: 1) organic macromolecules of the natural humic/fulvic materials originating from the decomposition of plant and animal residues, and/or 2) anthropogenic organic chelating agents, such as ethylenediamine tetraacetic acid (EDTA), because a number of which are known to have been disposed of within the Chemical Pit (Killey, et al, 1984; Robertson, 1986). Other potential forms of these migrating radionuclide-bearing anions may include inorganic colloidal materials and/or inorganic complexes composed of common aquo-anion ligands (sulfato-, chloro-, hydroxo-, etc., or combinations thereof).

It was also of interest to determine if the relative distribution of radionuclides between soluble anionic, cationic, and non-ionic forms changed as the groundwater moved down-gradient from the oxidizing environment of the pit area to the more reducing environment of the East Swamp area. Figure 3.5 shows that the relative abundances of cationic, anionic, and non-ionic forms of ^{60}Co changed very little as the radiocobalt moved from the pit area to the swamp. Apparently, the changes in the oxidizing conditions of the groundwater had little effect on the charge-form speciation of ^{60}Co . Similar behavior was noted for ^{106}Ru and $^{239,240}\text{Pu}$, but ^{125}Sb showed significant changes between non-ionic and anionic forms during this migration.

Figure 3.1 Changes in ^{60}Co concentration and chemical form with time in well ES-16 which is in the CRL Chemical Pit groundwater plume. Although the total concentration of ^{60}Co decreased significantly with time, the relative abundance of the cationic, anionic, and non-ionic species remained similar over the 11-year study period.

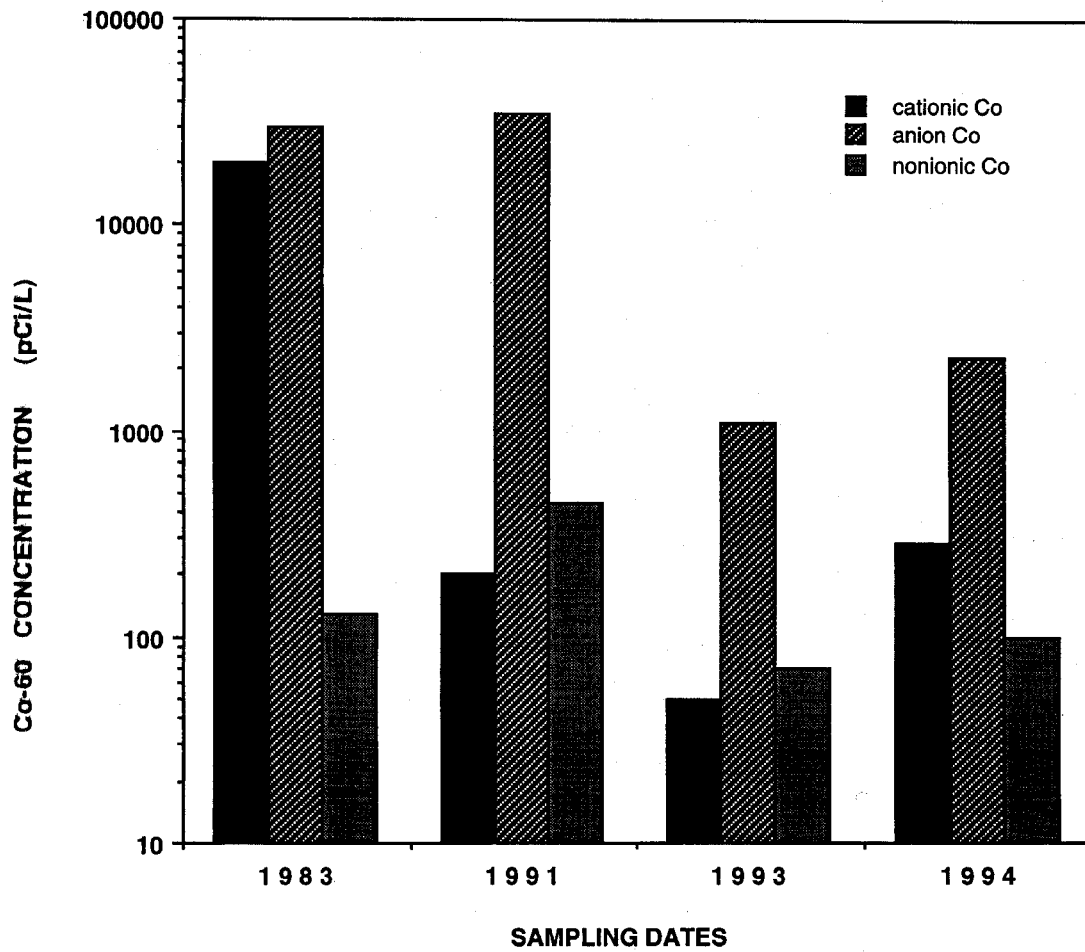

Figure 3.2 Changes in ^{106}Ru concentration and chemical form with time in well ES-16 which is located in the CRL Chemical Pit groundwater plume

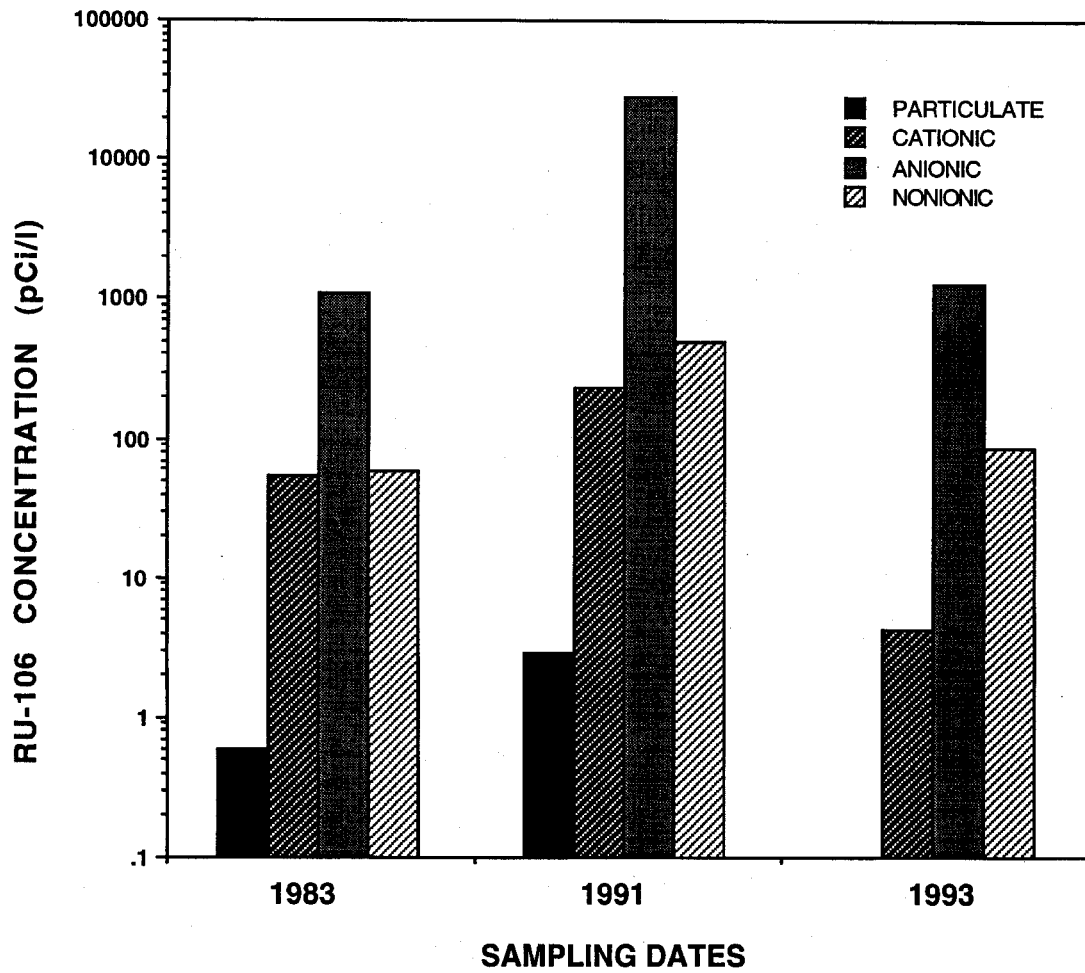

Figure 3.3 Change in ¹²⁵Sb concentration and chemical form with time in well ES-16 which is located in the CRL Chemical Pit groundwater plume

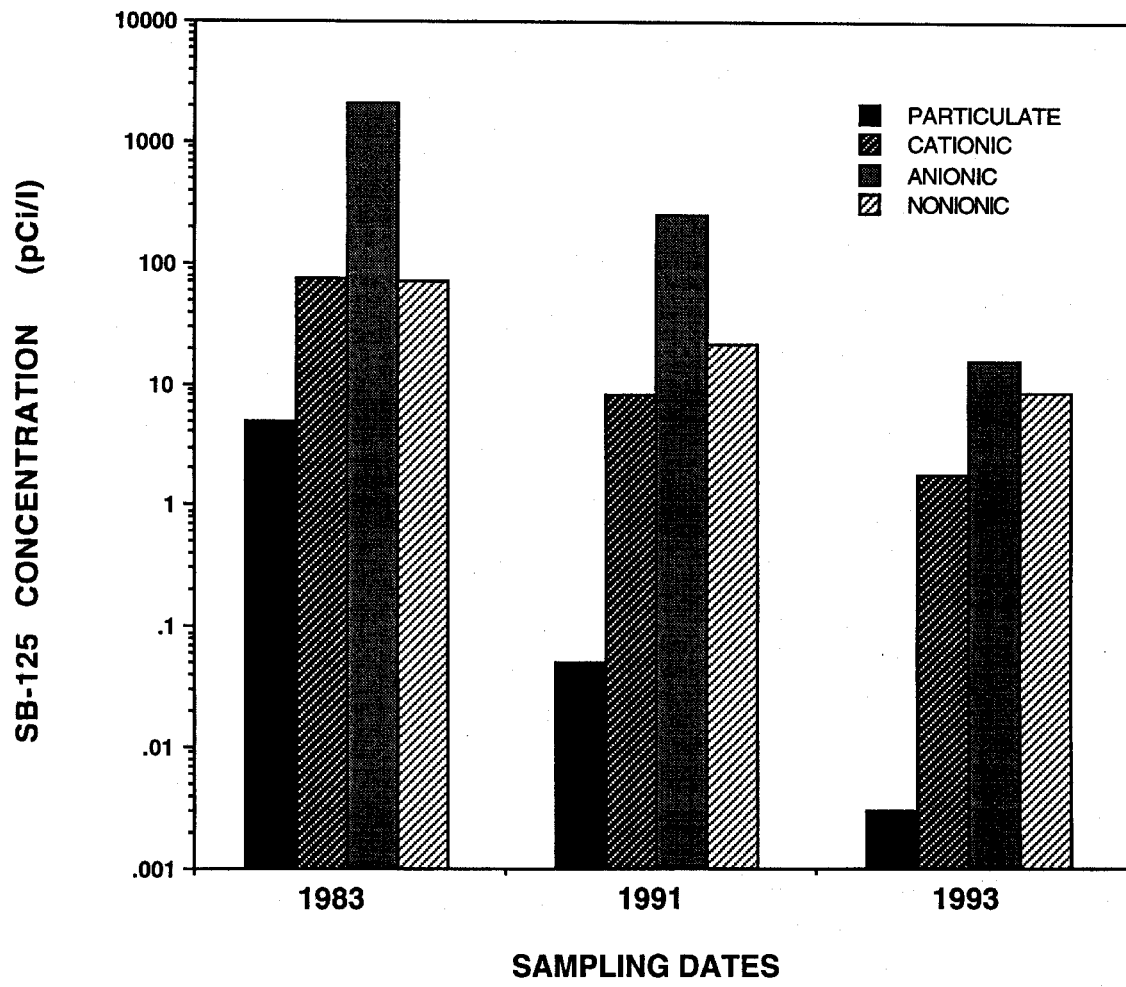

Figure 3.4 Change in $^{239,240}\text{Pu}$ concentration and chemical form with time in groundwater at well ES-16 which is located in the CRL Chemical Pit groundwater plume

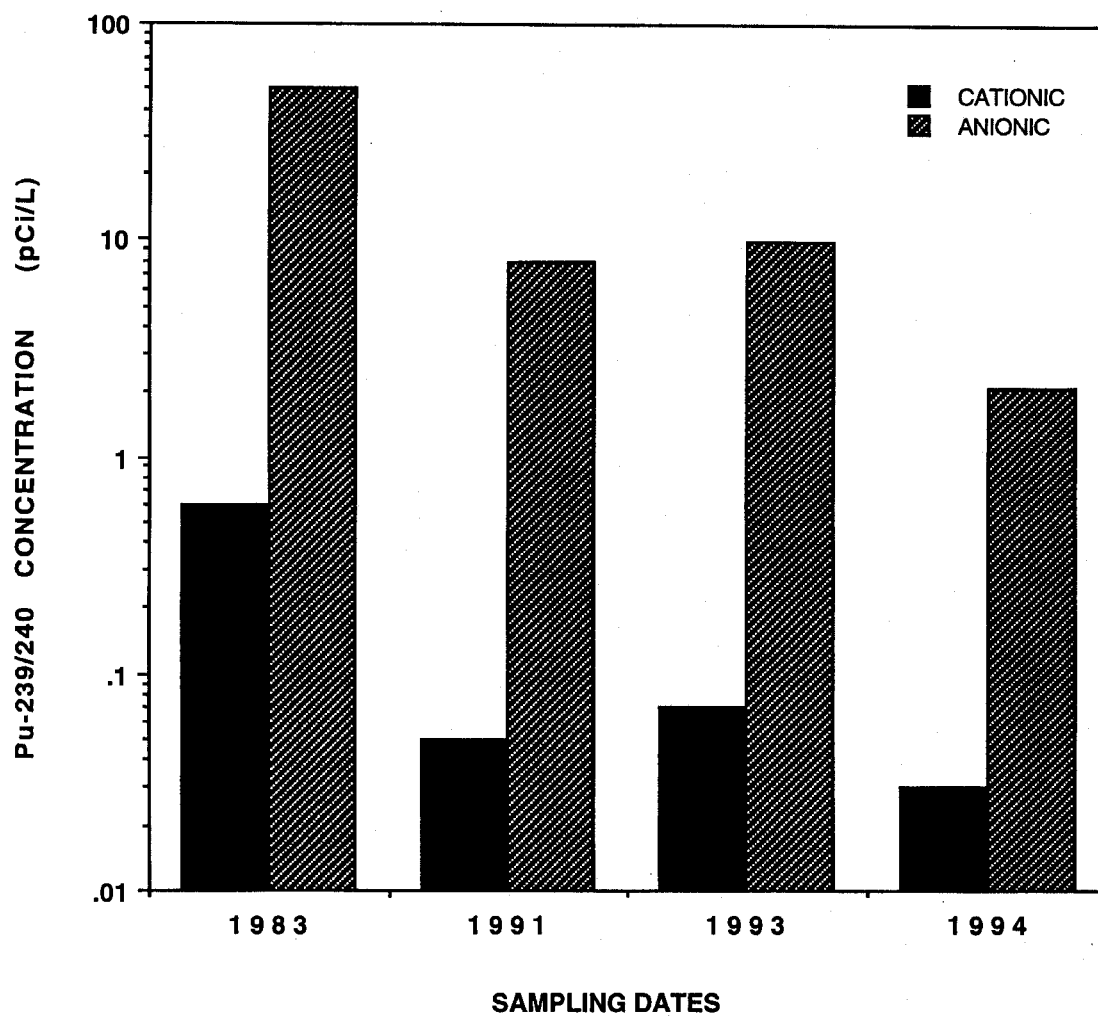
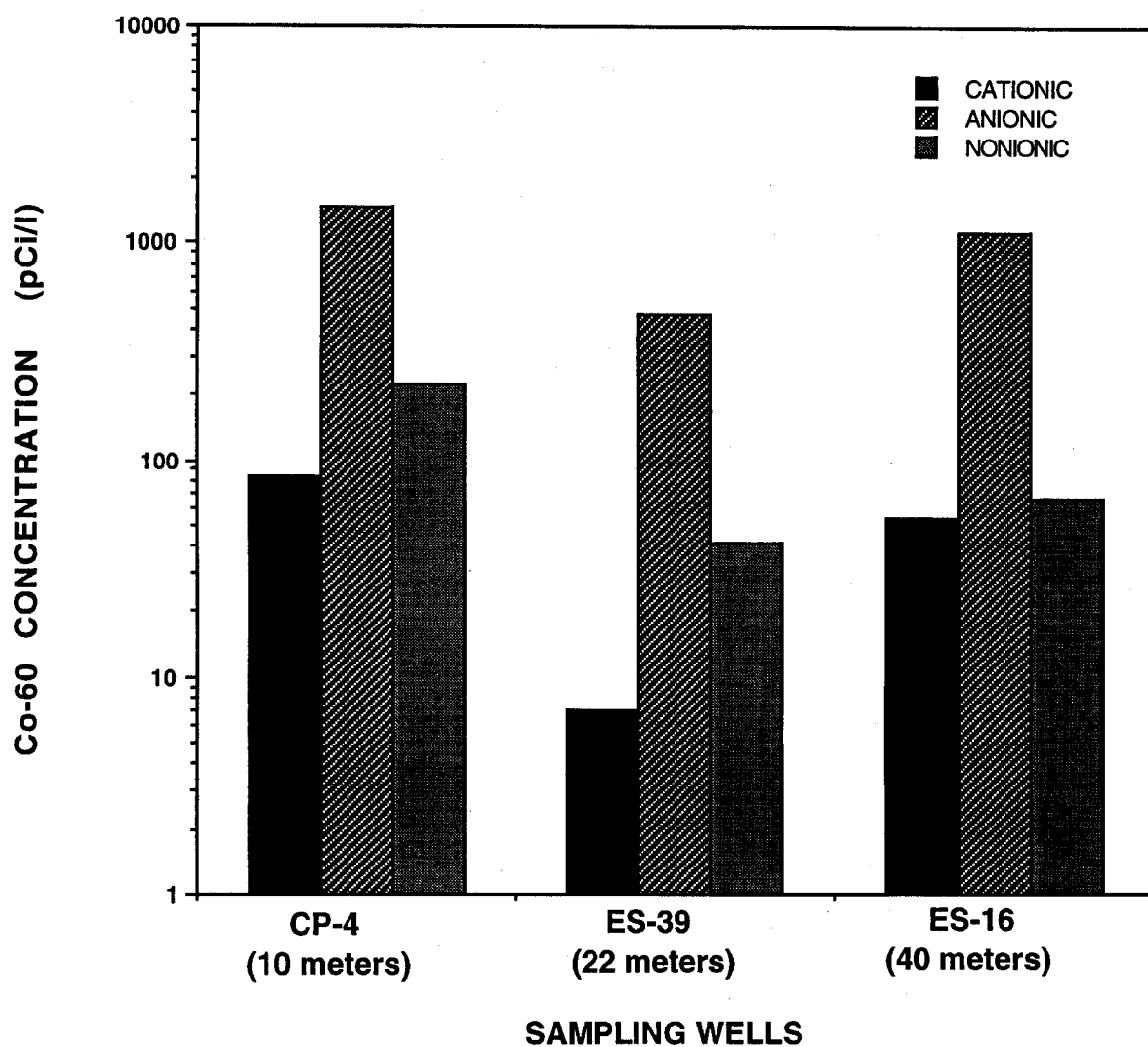

Figure 3.5 Change in ^{60}Co concentration and chemical form in the CRL Chemical Pit groundwater plume as a function of distance from the pit. These results show that the relative abundance of cationic, anionic, and non-ionic forms of ^{60}Co changed very little during transport from the oxidizing groundwater environment at wells CP4 and ES39 to the relatively reducing environment at well ES16 which is located in East Swamp.



3.2 Radionuclide Association with Colloids in Groundwater

3.2.1 Evolution of Colloid Speciation Along the Flowline

The results of particle size analysis carried out with Nuclepore membranes are summarized in Table 3.2 for samples collected from wells CP4, ES39 and ES16. Except for the higher concentration of suspended particles (> 450 nm) in CP4, colloid and suspended particle concentrations were low in the groundwater. Highest suspended particle concentrations were found in the most recently installed piezometer (CP4), and were lowest in the most developed (i.e. oldest and most heavily pumped) piezometer (ES16). When CP4 was sampled again in 1994 the concentrations of both particles and colloids were lower. Since the particle concentrations in these waters were too low to scatter sufficient light, the UPA required samples of particle concentrates to produce meaningful particle size distributions. Size analysis with the UPA indicated that CP4 contained particles from 20 to 2500 nm, with a high concentration of particles around 50 nm. Colloidal particles in ES39 were dominated by colloids ranging in size from 6 to 15 nm. The UPA could only detect particles smaller than 400 nm in ES16.

By analyzing the filtrate and retentate samples produced during groundwater filtration it was possible to calculate the groundwater concentration of a given element associated with dissolved species, colloids from 1 to 10 nm, colloids from 10 to 450 nm, and suspended particles larger than 450 nm. The concentration of dissolved elements is given by

$$\text{dissolved concentration} = F2 \quad (1)$$

where F2 represents element concentrations in the F2 filtrate (see Fig. 2.1). The groundwater concentrations of elements associated with colloids between 1 and 10 nm is given by

$$\text{colloids (1-10 nm)} = (R2-F2)/C2 \quad (2)$$

where R2 represents element concentrations in retentate R2, and C2 is the colloid concentration factor during filtration with the 10,000 NMWL membrane. The concentration factor is given by the sample volume before filtration divided by the volume of retentate. The concentration of elements associated with colloids between 10 and 450 nm can be calculated from equation 3 or equation 4. The reported value for these concentrations is the average of equations 3 and 4.

$$\text{colloids (10-450 nm)} = (F3-F1)/C1 \quad (3)$$

$$\text{colloids (10-450 nm)} = (R1-F1)/C1 - (4) \\ \text{particles (>450 nm)}$$

In the above equations F3 represents element concentrations filtered through the 450 nm filter, F1 is the filtrate from the 100,000 NMWL membrane, R1 is the retentate from the 100,000 NMWL filtration, and C1 is the colloid concentration factor for the 100,000 NMWL filtration.

The concentration of elements associated with suspended particles is given by the average of equations 5 and 6.

$$\text{particles (>450 nm)} = (R3-F3)/C3/C1 \quad (5)$$

$$\text{particles (>450 nm)} = (R1-F3)/C1 \quad (6)$$

Since the fraction of dissolved salts that was concentrated along with the colloids was between 0 and 4 percent, it is necessary to account for salt retention when calculating colloid compositions from particle concentrates. First, the percent of a given element's groundwater concentration, which was enriched in the particle concentrate was calculated. Then the measured percent salt retention, determined by conductivity, was subtracted from this value. The amount of the given element associated with colloids was calculated from the "corrected" percent.

Table 3.1 Gravimetric particle size analysis of micro-particulates in groundwater collected down-gradient from the Chemical Pit

CP 4 1993	SIZE (nm)	mg/L
	10000	0.097
	5000	0.710
	1000	0.691
	400	0.026
	100	0.048
	50	0.072
	15	0.084
	total particles (> 450 nm)	1.523
	total colloids (10 - 450 nm)	0.2
CP4 1994	SIZE (nm)	mg/L
	10000	0.103
	5000	0.059
	1000	0.106
	400	0.012
	100	0.003
	50	0.059
	15	0.000
	total particles (> 450 nm)	0.280
	total colloids (10 - 450 nm)	0.062
ES 39	SIZE (nm)	mg/L
	10000	0.064
	5000	0.058
	1000	0.316
	400	0.070
	100	0.073
	50	0.097
	15	0.134
	total particles (> 450 nm)	0.509
	total colloids (10 - 450 nm)	0.304
ES 16	SIZE (nm)	mg/L
	10000	0.053
	5000	0.050
	1000	0.046
	400	0.064
	100	0.051
	50	0.058
	15	0.064
	total particles (> 450 nm)	0.214
	total colloids (10 - 450 nm)	0.173

The results of radiochemical analysis carried out at CRL on filtrate and retentate samples

were used to determine radionuclide activities for dissolved and colloidal species. The results

of the determinations for the gamma-emitters are given in Table 3.2. It is evident from the data that dissolved species (< 10,000 NMWL or 1 nm) dominated in the cases of all the measured gamma-emitters in these samples. The results for dissolved ⁶⁰Co and ¹²⁵Sb showed a downward trend away from the pit. However, dissolved ¹⁰⁶Ru shows a trend in concentration in the opposite direction. This probably reflected the lack of recent inputs of this mobile and short-lived radionuclide to the pit (i.e. ¹⁰⁶Ru was being flushed out of the aquifer).

The results of size analyses of the actinides are given in Table 3.3. The concentrations of actinides in the plume were very low and consequently the errors in the analyses were quite high, particularly for the minor fractions. This accounted for some values in the table being negative. Since the well at CP4 was freshly installed in 1993 and showed a high particulate content, it was decided to re-sample it again in March of 1994. Unfortunately, due to a process upset in the waste treatment plant late in 1993 and

freezing of transfer lines early in 1994, the Chemical Pit received some unusual inputs between the two sampling periods. As had been anticipated, the 1994 results for CP4 showed a lower particulate component for the actinides than the 1993 results. The concentrations of the dissolved components for all of the actinides, except ²⁴⁴Cm were higher in CP4 in 1994. Although this may be due to the addition of wastes to the pit prior to the second sampling, it might also be due to a seasonal trend to higher concentrations in the winter, when the ground was frozen and there was no water infiltration from the surface. This trend had been observed in previous work in the same plume. The concentrations of dissolved ²³⁸U, ²³⁷Np and ²⁴⁴Cm showed a downward trend away from the pit, but ^{239/240}Pu and ²³⁸Pu+²⁴¹Am (which is probably mostly ²³⁸Pu) showed an upward trend.

In summary, visual inspection of the groundwater indicated that the suspended load was very small. This was confirmed by the particle size analyses (Table 3.2) where total particles were only a small fraction of

Table 3.2 Size Fractionation of Gamma-Emitters

Sample	Element	Dissolved	Radionuclide Concentration (pCi/kg)		Suspended Particles (>450 nm)
			Colloid (1-10 nm)	Colloid (10-450 nm)	
CP4	Sb-125	1070	0.0	3.48	1.40
	Ru-106	8610	508	0.0	9.26
	Co-60	13,200	286	140	8.02
ES 39	Sb-125	350	16.1	5.24	0.00
	Ru-106	9020	713	621	92.9
	Co-60	9260	122	237	0.00
ES 16	Sb-125	210	14.5	8.91	1.40
	Ru-106	14300	721	302	9.26
	Co-60	7510	178	102	8.02

Table 3.3. Size fractionation of actinides found in groundwater collected down-gradient from the Chemical Pit

Sample	Element	Radionuclide Concentration pCi/L (numbers in parentheses are % of total species)			
		Dissolved	Colloid		Particulate
			1-10 nm	10-450 nm	
CP4 1994	U-238	0.474 (82)	0.072 (12)	0.032 (6)	-0.019
	Np-237	0.772 (79)	0.123 (13)	0.079 (8)	-0.046
	Pu-239/240	3.37 (61)	1.35 (24)	0.845 (15)	-0.039
	Pu-238 + Am-241	4.87 (76)	1.22 (19)	0.356 (5)	-0.160
	Cm-244	0.481 (81)	0.076 (13)	0.037 (6)	-0.028
CP4 1993	U-238	0.549 (62)	0.213 (24)	0.100 (11)	0.024 (3)
	Np-237	0.482 (47)	0.180 (18)	0.136 (13)	0.222 (22)
	Pu-239/240	2.27 (33)	2.57 (37)	1.34 (19)	0.766 (11)
	Pu-238 + Am-241	1.67 (31)	2.20 (41)	0.266 (5)	1.23 (23)
	Cm-244	0.483 (59)	0.250 (31)	0.085 (10)	-0.017
ES39 1993	U-238	0.438 (68)	0.110 (17)	-0.064	0.095 (15)
	Np-237	0.494 (80)	0.073 (12)	-0.020	0.048 (8)
	Pu-239/240	1.99 (64)	0.411 (13)	0.301 (10)	0.402 (13)
	Pu-238 + Am-241	3.98 (82)	0.424 (9)	0.216 (4)	0.255 (5)
	Cm-244	0.926 (71)	0.216 (17)	0.120 (9)	0.044 (3)
ES16 1993	U-238	0.262 (70)	0.072 (19)	0.001 (0.3)	0.037 (10)
	Np-237	0.315 (71)	0.055 (12)	0.024 (5)	0.047 (11)
	Pu-239/240	3.30 (83)	0.422 (11)	0.158 (4)	0.110 (3)
	Pu-238 + Am-241	7.75 (93)	0.450 (5)	0.161 (2)	-0.099
	Cm-244	0.290 (84)	0.033 (9)	0.023 (7)	-0.007

the groundwater sampled. For the gamma-emitting radionuclides (Table 3.2), the dissolved fraction accounted for 86-99% of the total radioactivity of these isotopes present in the groundwater. For the actinide radionuclides (Table 3.3), the dissolved fraction became increasingly large in the groundwater as a function of distance from the Chemical Pit, and accounted for 70 to 93% of the total actinide elements present in the groundwater. Thus, the dissolved fraction of all radionuclides was the predominant form being transported in the groundwater, and colloidal transport amounted to only 7-30 % depending upon the radionuclide. Similar results were observed in 1993 for the gamma-emitting radionuclides, and these data were reported by Schilk, et al., 1995.

3.2.2 Evolution of Chemical Speciation Along the Flowline

The soluble radionuclide speciation in portions of the <10,000 NMWL (1 nm) filtrates from the three wells was measured by anion exchange chromatography using the technique described in Section 2.3.2 of this report. The three samples were loaded and chromatographed with a 25 cm analytical column at a flow rate of 6 mL per minute. The ^{60}Co chromatograms for these samples are shown in Figure 3.6. Seven peaks were identified across all of the chromatograms and these are numbered in the figure. The species that eluted in KCl were likely being displaced by competition from Cl^- ions. In previous work (Cooper et al., 1995) size exclusion chromatography showed that some of these species have higher molecular weights than simple cations, indicating that they were being displaced from the columns as complexes. On the other hand, species that eluted in 0.1 M HCl had lower molecular weights. These species, which are strongly retained by the AG MP-1 resin, were probably being destabilized at the lower pH. Once the complexes broke down, the cations liberated from them were eluted from the columns.

There was clearly an evolution in chemical speciation of ^{60}Co as the groundwater flowed from the pit (CP4) towards the wetland (ES39 and ES16). The integrated counts (CPM/L) in the peak regions are given in Table 3.4. The

dominant peak was number 4 and it reached a maximum at ES39. Peak 3 was at its minimum at ES39. It is possible that these 2 peaks were poorly resolved in the chromatogram for the sample from ES39 and this accounted for the observed differences in the counts at ES39. Peaks 1, 2, 5, 6 and 7 declined as the groundwater flowed towards the wetland. The dissolved ^{60}Co species that eluted in KCl dominated over the ones that eluted in HCl.

The chromatograms obtained for ^{106}Ru are shown in Figure 3.7. Since the counting statistics for ^{106}Ru were poorer, the chromatograms showed more scatter than those of ^{60}Co . Peaks 2 and 4 were fairly constant down the flow system. Peak 1 declined with distance from the pit, while peaks 3 and 5 increased. The heights of the peaks in KCl and HCl were similar, although more ^{106}Ru eluted in the KCl.

Chromatograms obtained for ^{238}U appear in Figure 3.8. Most of the ^{238}U eluted in HCl. The peak height showed a minimum at ES39. Most of the ^{237}Np species shown in Figure 3.9 also eluted in HCl. However, the maximum peak height appeared at ES39. There was also evidence for peaks in the KCl gradient at CP4 and ES16 (Figure 3.10), but little evidence of the same peak at ES39. The results for ^{237}Np were corrected for ^{234}U by using the counts from the ^{238}U peak and assuming that the two U isotopes were in equilibrium.

Figure 3.11 shows the chromatograms obtained for $^{239/240}\text{Pu}$. Here again most of the species eluted in HCl, but peaks in KCl were becoming more intense. These are shown in more detail in Figure 3.12. Although CP4 and ES16 showed only a single peak in the gradient, there were two distinct peaks at ES39.

Chromatograms for ^{241}Am are shown in Figure 3.13. Since these results were obtained from total actinide sources, the ^{241}Am counts had to be corrected for ^{238}Pu . The $^{238}\text{Pu}/^{239/240}\text{Pu}$ ratio was established from fractions which showed separation of Pu from Am and Cm. This ratio was then used to correct the results from the rest of the fractions. Having to apply the

correction increased the uncertainty in the results for fractions that eluted in HCl, so it was difficult to interpret this region in the chromatograms. Americium eluted earlier than plutonium in the KCl gradient and two peaks appeared to be present. The first peak declined with increasing distance from the pit, while the second one declined towards ES39 and increased again at ES16.

Figure 3.14 shows the chromatograms obtained for ^{244}Cm . Most of the species eluted in the KCl gradient and there were two peaks, which were similar to ^{241}Am . The first peak reached a maximum at ES39, while the second peak was greatest at ES16. The elution of the ES16 sample in HCl showed the presence of a delayed peak, which was not present in the other two chromatograms.

Figures 3.8 through 3.13 show an interesting trend in speciation going up the actinide series. The lower actinides were strongly retained by the resin and were mostly

removed by the HCl elution, probably through destabilization of the complexes. The higher actinides were less strongly retained by the resin and were eluted earlier in the KCl gradient. Fewer of their complexes remained on the columns long enough to be eluted in HCl.

In summary, the anion chromatographic separations of the soluble (< 1 nm) fraction from the ultra-filtration of groundwater from wells CP4, ES39, and ES16 demonstrated the presence of multiple chemical species for each radionuclide. For ^{60}Co and ^{106}Ru , at least 5-7 specific chemical species were observed. For most of the actinide radionuclides, the number of individual species was fewer than observed for the ^{60}Co and ^{106}Ru , with about 2-4 species generally being observed. This points out how complicated the chemical speciation of radionuclides being transported in groundwater can be, and clearly shows that numerous natural organo-radionuclide complexes simultaneously exist in groundwater at this site.

Table 3.4 Summary of counts in the peaks of chromatograms from ultra-filtered samples

Peak #	CP4-F2	ES39-F2	ES-16-F2	ES16
1	100	60	62	30
2	216	191	68	78
3	502	266	450	402
4	1203	1419	1072	1022
5	232	247	131	108
6	122	74	75	140
7	283	125	115	406

Figure 3.6 Co-60 Chromatograms for samples from the three wells

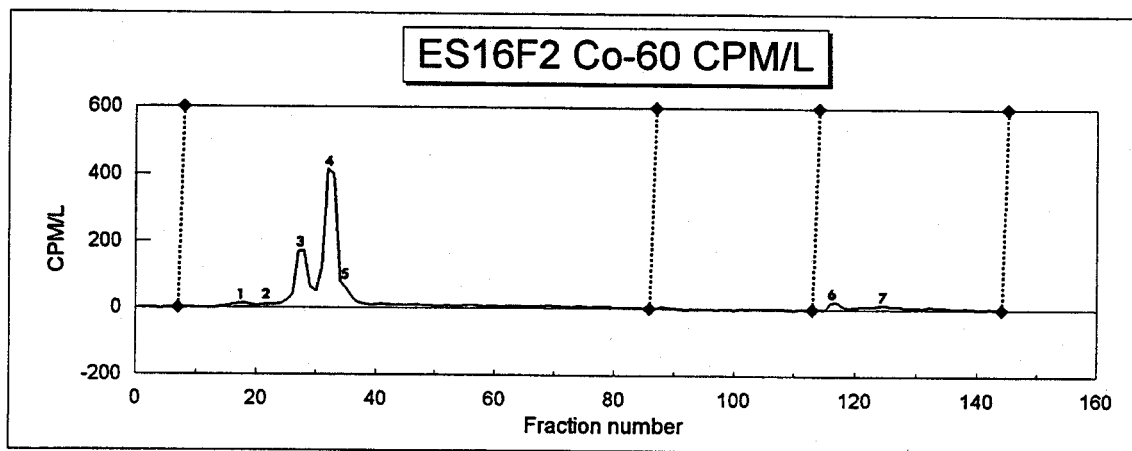
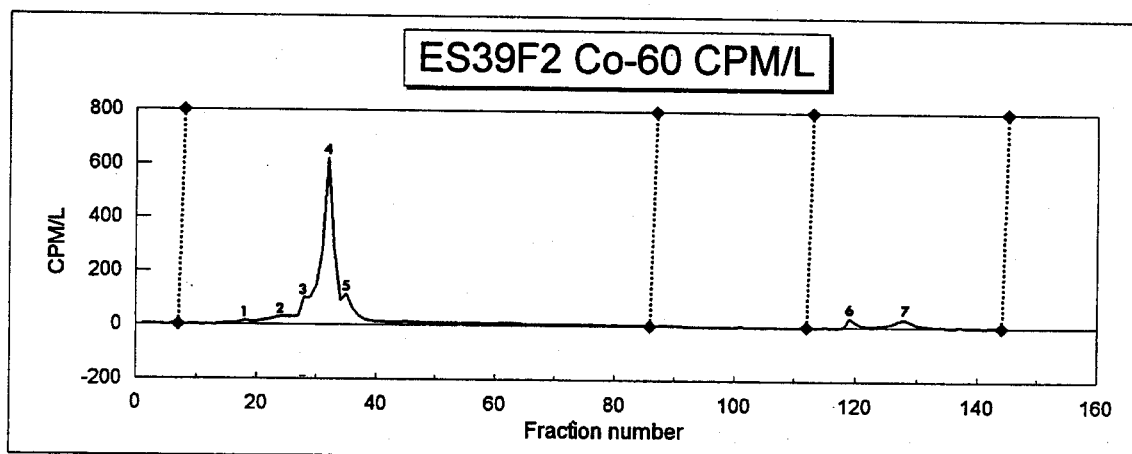
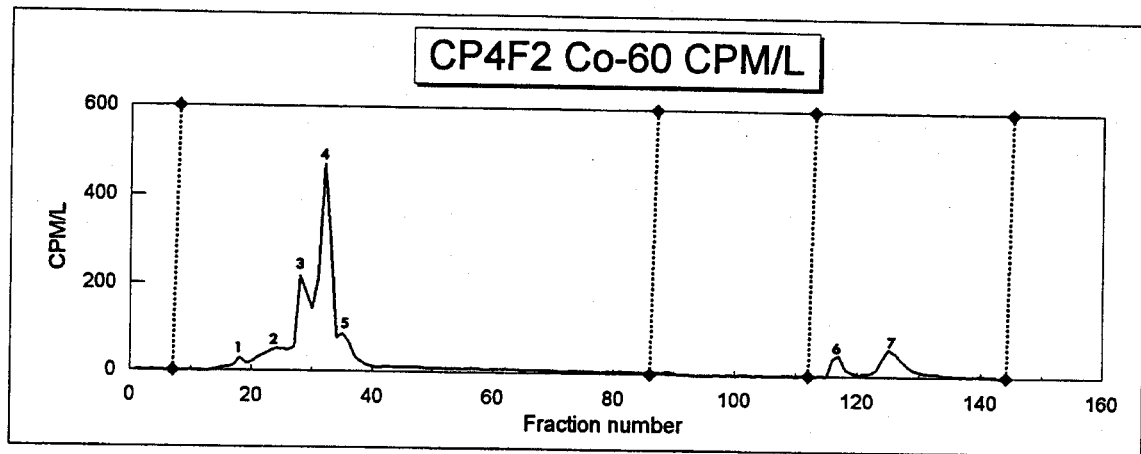

Vertical lines show eluent changes

Figure 3.7 Ru-106 chromatograms for samples from the three wells

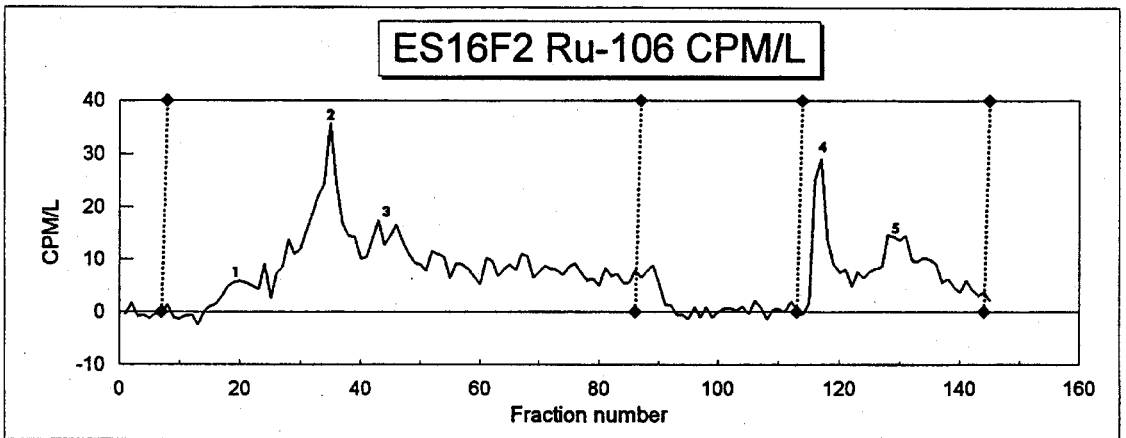
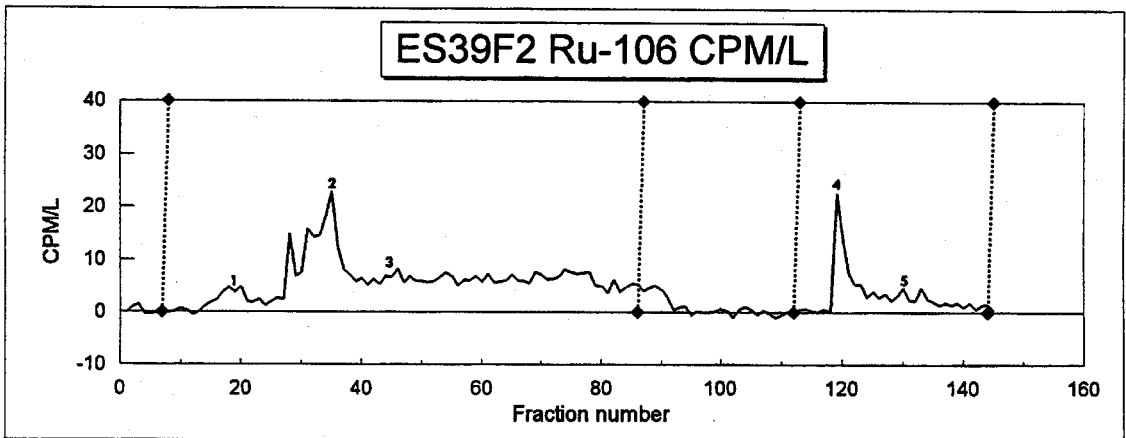
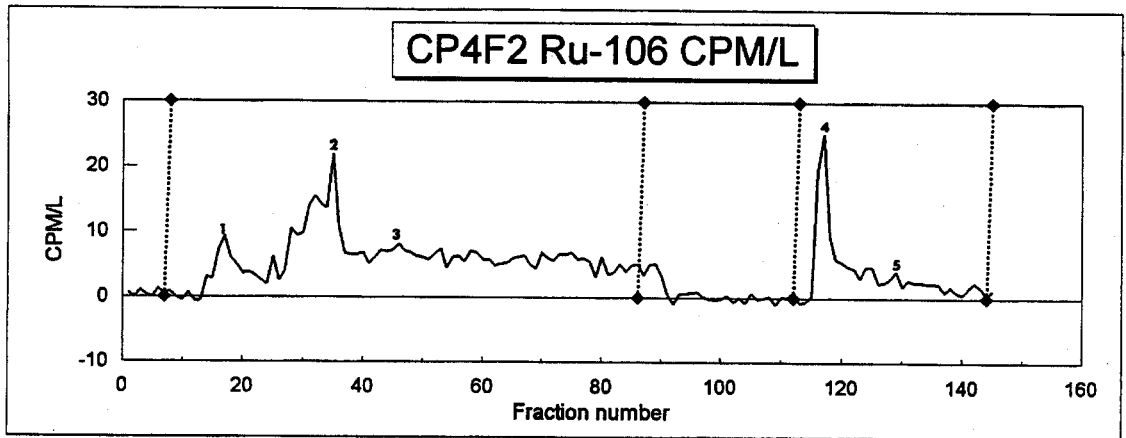

Vertical lines show eluent changes

Figure 3.8 U-238 chromatograms for the samples from the three wells

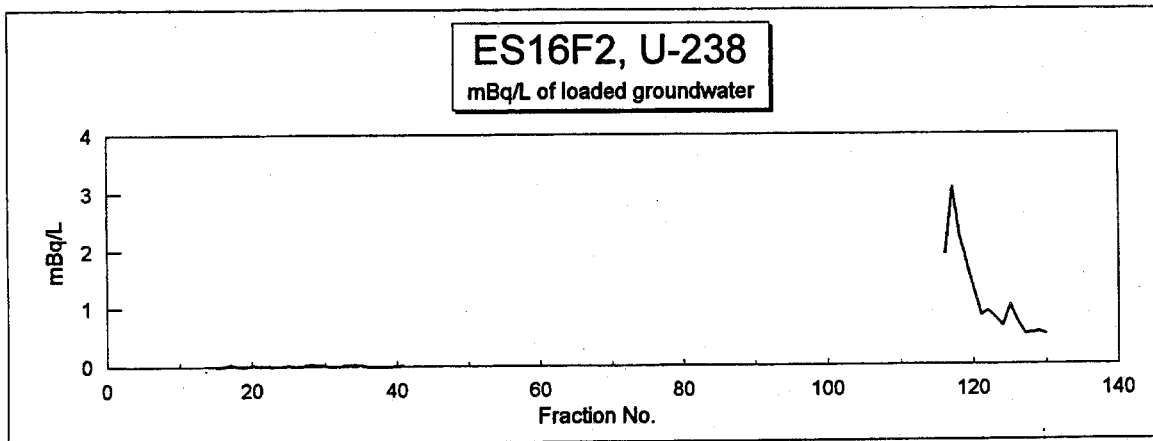
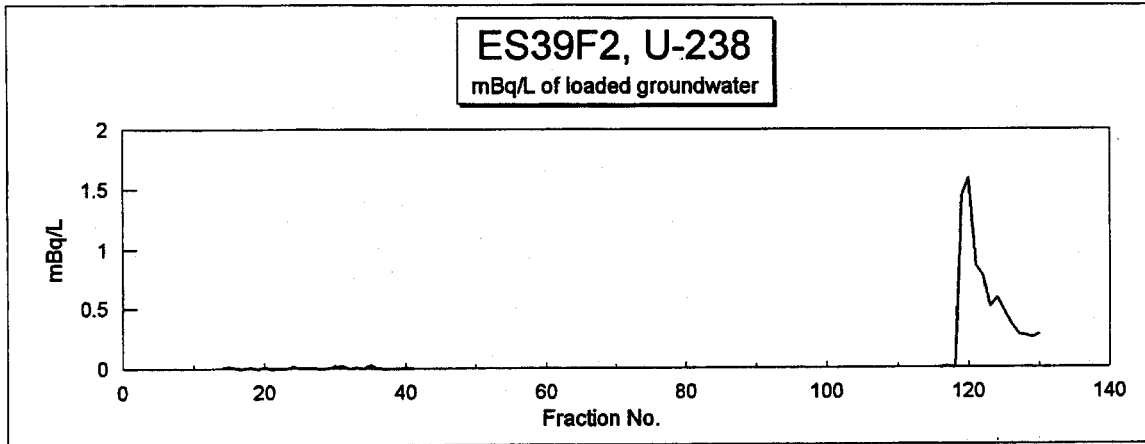
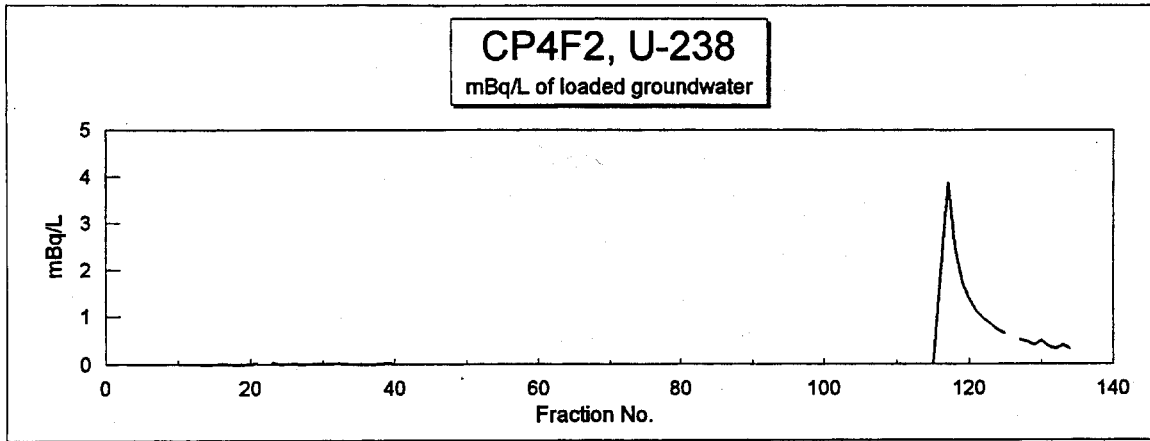

Figure 3.9 Np-237 chromatograms for samples from the three wells

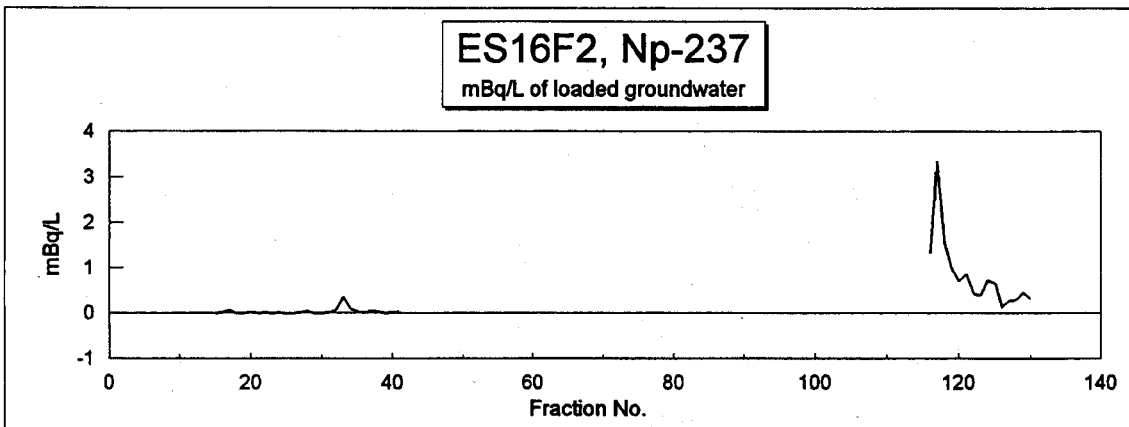
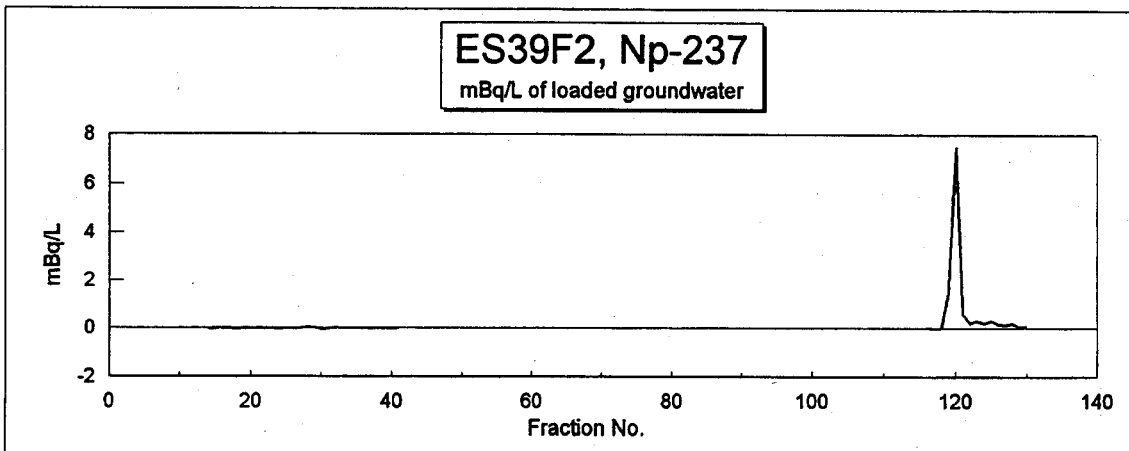
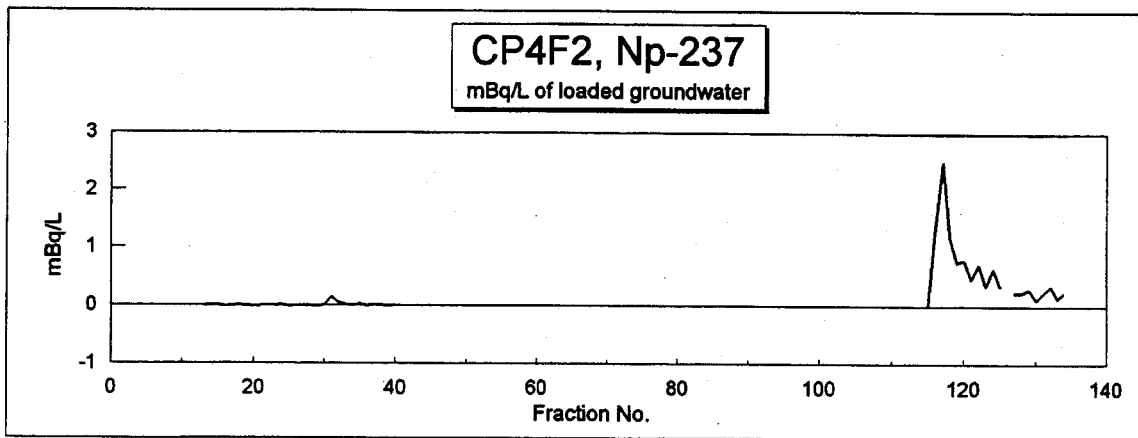

Figure 3.10 Np-237 chromatograms for samples from the three wells

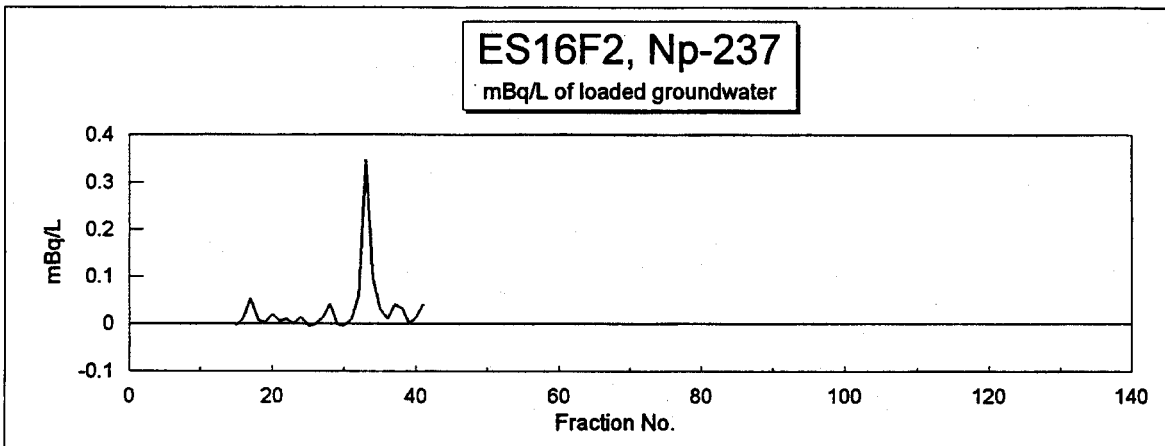
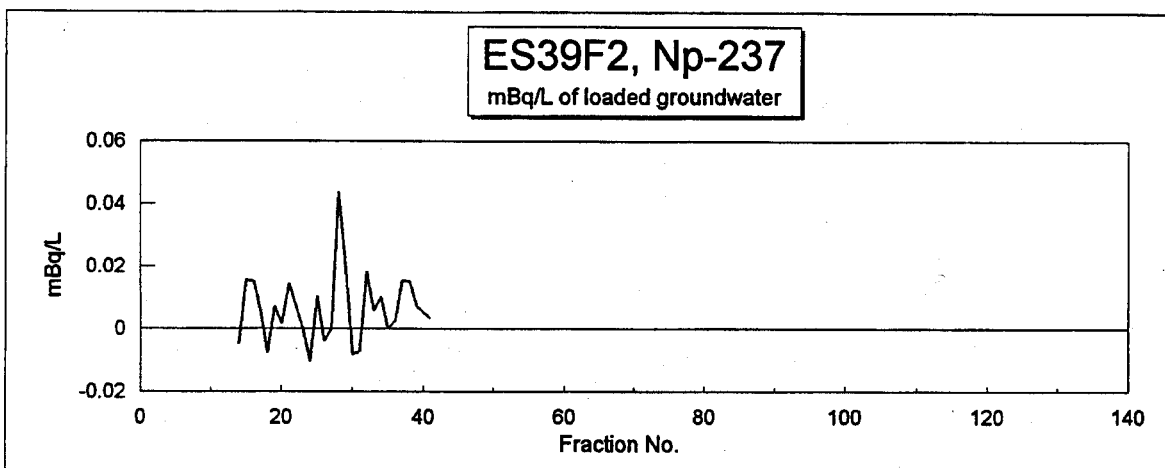
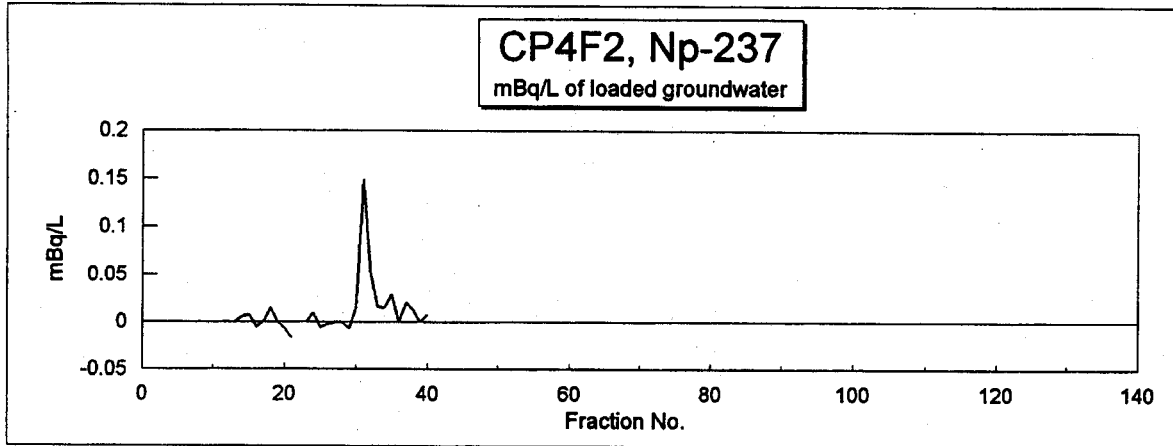

Figure 3.11 Pu-239+240 chromatograms for samples from the three wells

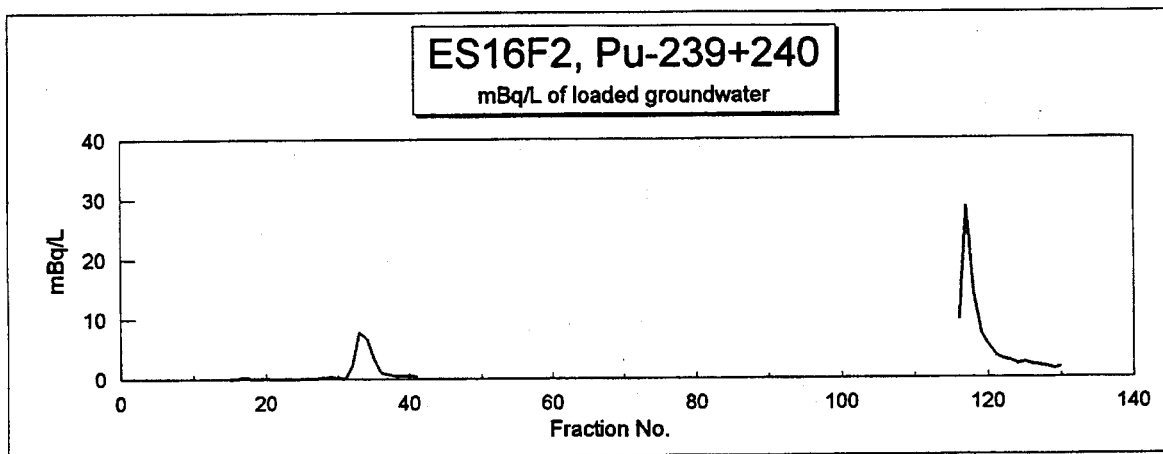
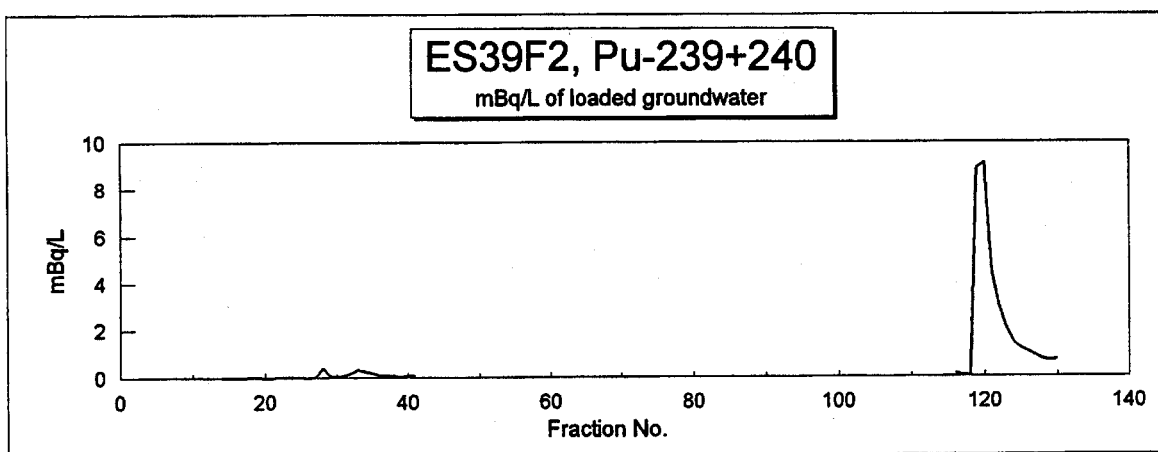
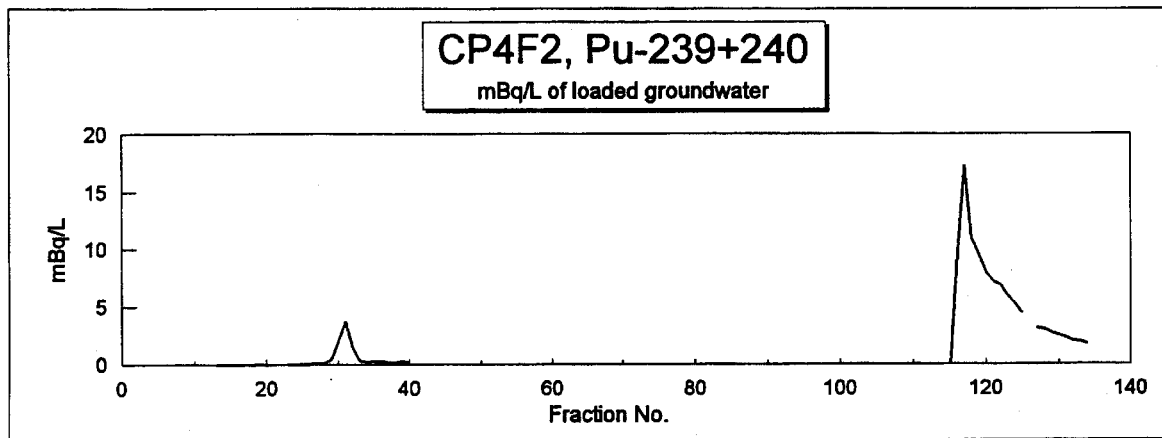

Figure 3.12 Pu-239+240 chromatograms for samples from the three wells

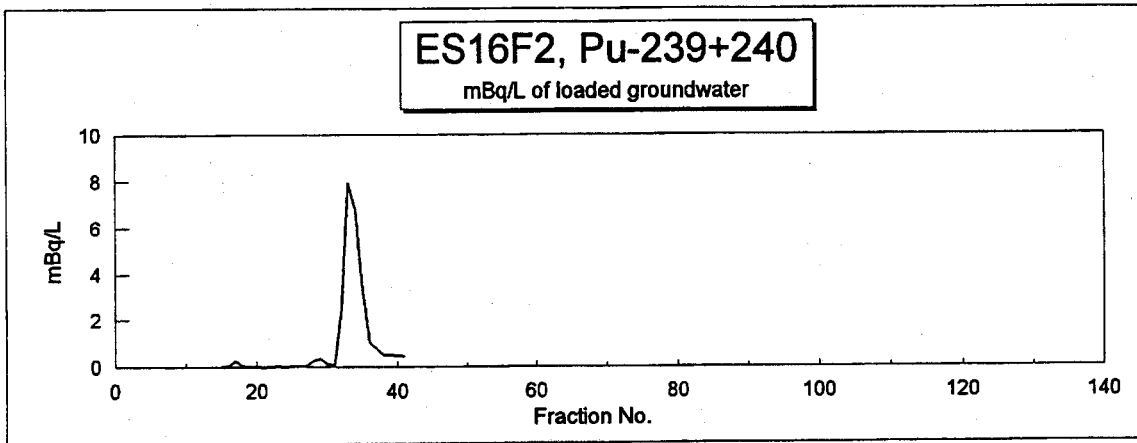
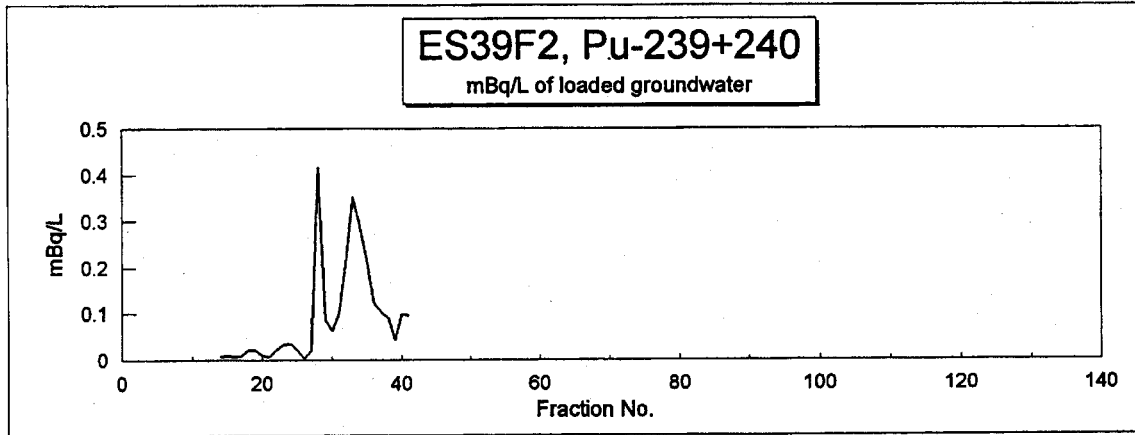
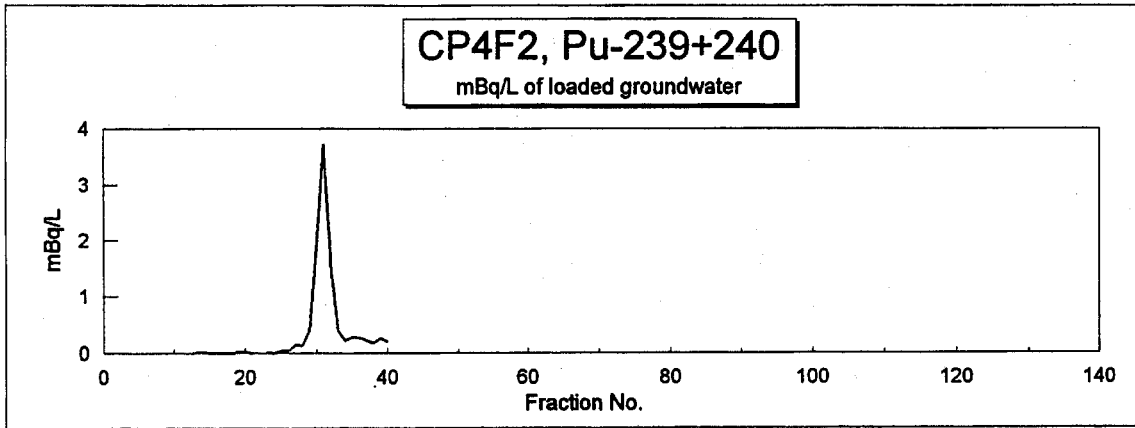

Figure 3.13 Am-241 chromatograms for the samples from the three wells

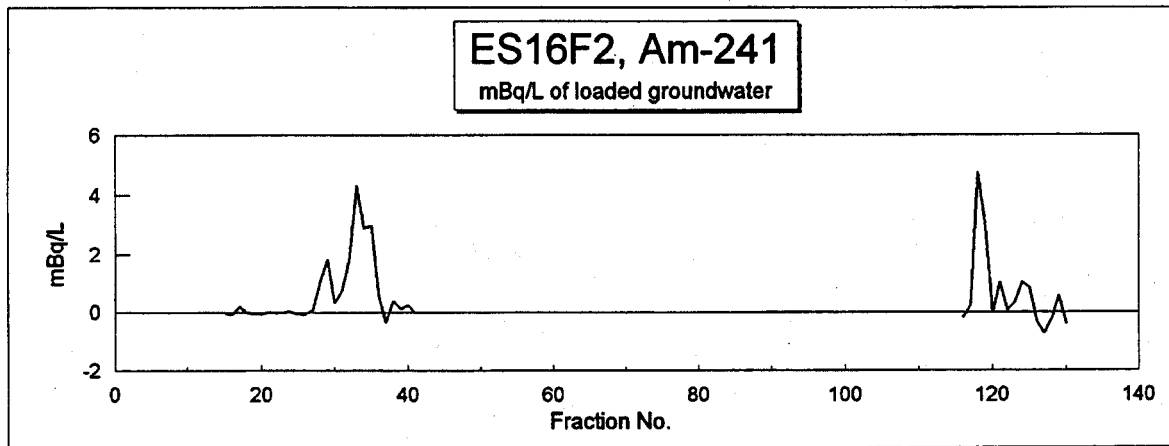
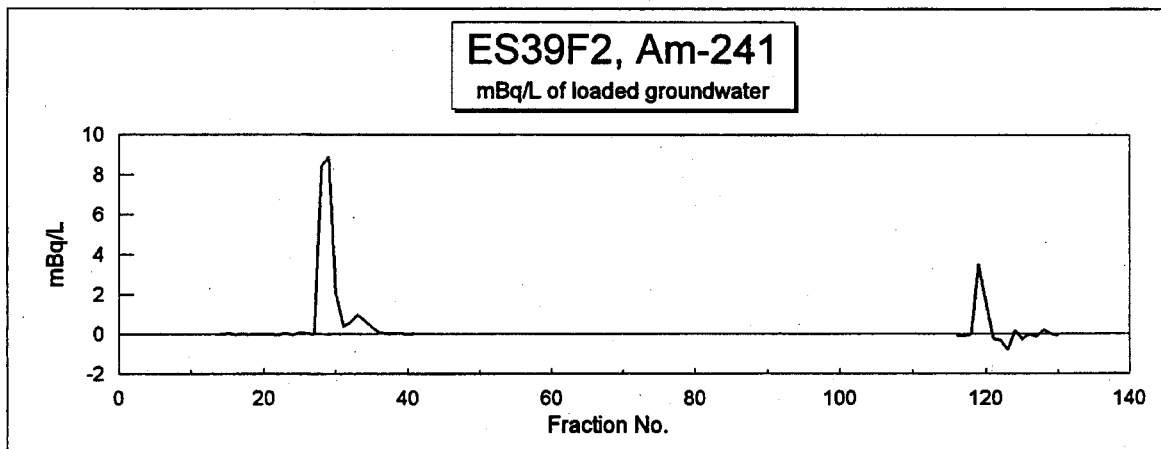
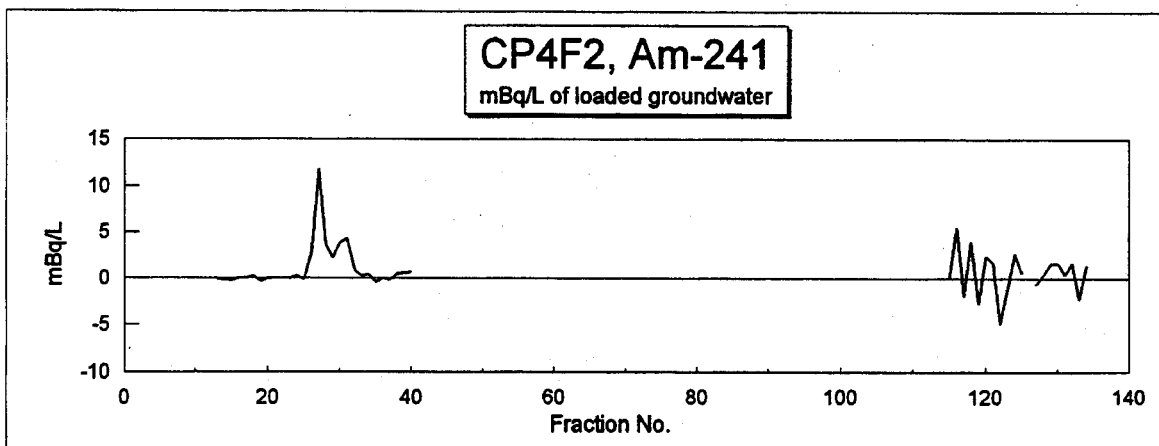
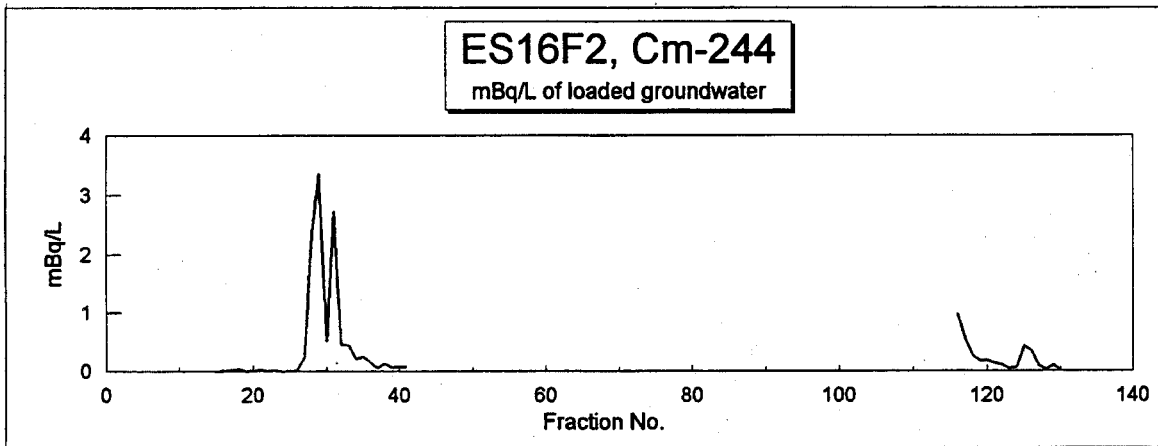
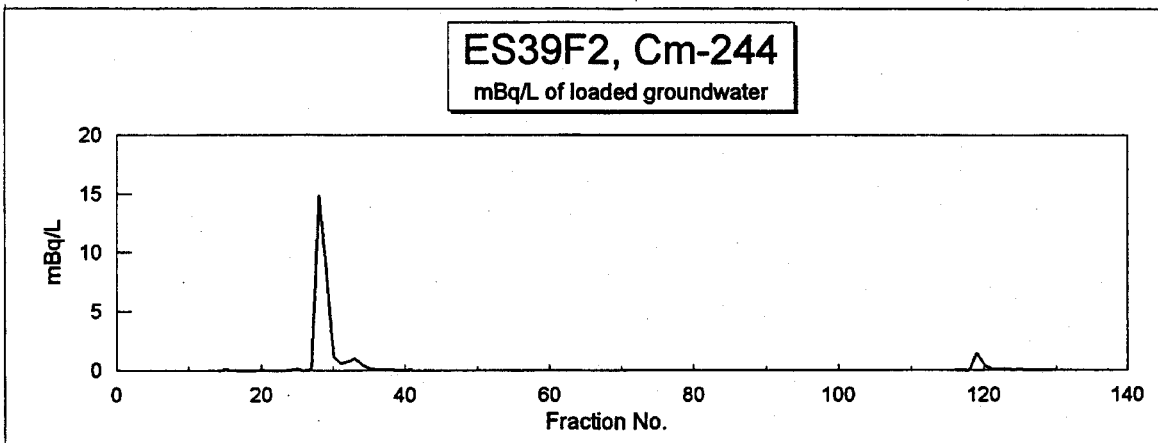
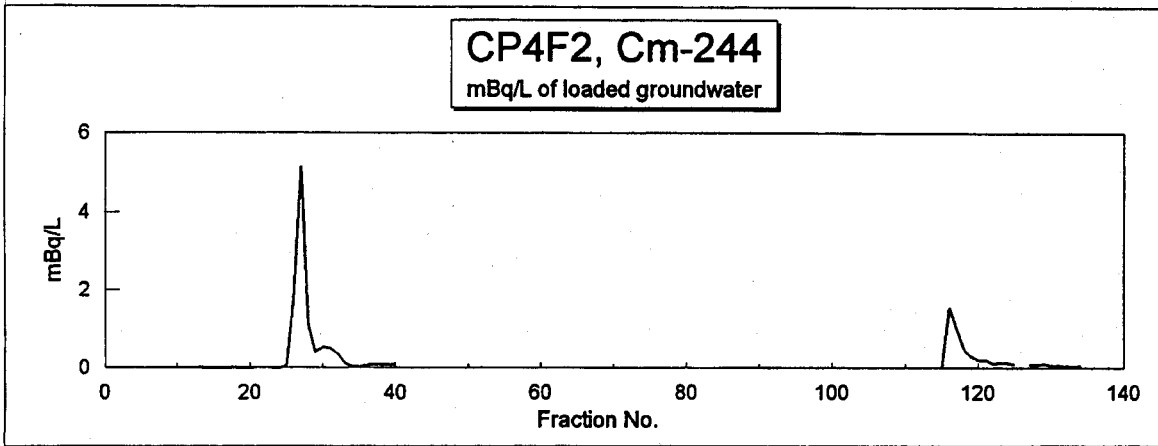

Figure 3.14 Cm-244 chromatograms for samples from the three wells



3.3 Speciation of Radionuclides and Organics in Groundwater

As described in Section 2.4, a series of anion exchange chromatography experiments were conducted to separate a number of soluble physicochemical species of ^{60}Co and ^{137}Cs from groundwater sampled at well ES16. In this technique, the anionic radionuclide species were first sorbed from groundwater onto anion exchange resin and then eluted off the resin with increasingly stronger solutions to remove the different physicochemical species. Organic chemical species, as determined by UV absorption, were also separated and measured by this technique.

In earlier work the elution gradient was generated with a pump and mixing chamber, which made it difficult to generate complex gradients, so a simple linear 0 to 0.5 M KCl gradient was used. The availability of the gradient programmer for the present work allowed more flexibility in generating gradients. The decision was made to split the KCl gradient into two segments because there seemed to be few distinct species eluting in the latter part of the gradient in previous work. By splitting the gradient, the slope could be kept lower in the first half (0 to 0.25 M) where the peaks eluted. The slope of the second half (0.25 to 0.5 M) was increased to save time. The direct transition to 0.1 M HCl used in initial runs in this series resulted in a shock which mobilized a lot of species and produced a peak in the UV chromatogram that went off scale. This shock was lessened by using a gradient for the transition from KCl to HCl.

A sample of ES16 groundwater was collected on April 22, 1996 and chromatographed on May 7. The chromatogram obtained for ^{60}Co is shown in Figure 3.15. The vertical lines show the changes in eluent. These are from left to right: pH 4.5 HCl, 0 to 0.25 M KCl gradient, 0.25 to 0.5 M KCl gradient, 0.5 M KCl, 0 to 0.1 M HCl gradient and 0.1 M HCl. There were five distinct peaks in the first KCl gradient and one in the HCl gradient. A similar chromatogram obtained with a sample collected from the same well in 1993 is shown

in Figure 3.16 for comparison. In this case the loading and elution were carried out at 6 mL/min. The vertical lines again show changes in eluent. In this case these are from left to right: pH 4.5 HCl, 0 to 0.5 M KCl, 0.5 M KCl and 0.1 M HCl. Although the KCl gradient was changed in 1996, the 0 to 0.25 M gradient was comparable to the first half of the 0 to 0.5 M HCl gradient in 1993, since the slopes in KCl concentration with eluent volume were the same. The 1993 chromatogram was dominated by two distinct peaks in the first half of the KCl gradient. These were much higher than the peaks in the 1996 chromatogram, which reflected the decline in ^{60}Co concentration since the use of the pit was discontinued in 1996. The retention times of the two peaks in the 1993 chromatogram corresponded to peaks 3 and 4 in the 1996 chromatogram. The 1993 chromatogram also showed two peaks in 0.1 M HCl compared to only one in the 1996 chromatogram. The retention times could not be compared in the HCl portions of the two chromatograms, since the elution was changed in 1996. The two chromatograms showed that there were distinct changes in the speciation over the period of almost three years between the sampling dates. This was reflected in the numbers and intensities of the peaks in the two chromatograms.

The UV chromatogram from the April 22, 1996, sample is shown in Figure 3.17. Seven peaks in absorbance can be identified. Peaks 1 to 4 occur in the first KCl gradient where five peaks appear in the ^{60}Co chromatogram. Peak 1 is very sharp, but peaks 3 and 4 are poorly resolved. Peak 5 is a very broad peak which starts in the KCl gradients and declines in the 0.5 M KCl. The sixth peak, which elutes in the 0 to 0.1 M HCl gradient is very sharp. Peak 7 is a broad peak, which starts in the HCl gradient and continues into the 0.1 M HCl. Since the peak had not declined to the baseline by the end of the HCl elution, the volume of 0.1 M HCl used for elution was increased in subsequent runs.

The speciation of the organics was examined in more detail by measuring the UV absorbance spectra of selected fractions. The spectra are shown in the figures in Appendix

3. The noise between 350 and 400 nm is an artifact of the UV detector. The spectra obtained from fractions eluted with KCl generally don't show remarkable features. The peaks in absorbance numbered 1 to 5 seem to be due to a broad-band increase in absorbance across the UV spectrum. The spectrum from fraction 65 shows a broadening of the initial peak. This indicates an increase in absorbance between about 210 and 250 nm, but there is not a distinct peak. The absorbance appears to increase between 250 and 300 nm, but again there is no distinct peak. The spectra of fractions eluted with HCl show more features, with an increase in absorbance around 240 nm. A broad peak around 340 nm is also evident in some of these fractions. Spectra obtained from surface water from Mainstream are also shown at the end of Appendix 3. This stream, which is in the same basin as ES16 has highly coloured, organic rich water. The sample had to be diluted with water to bring the absorbance on scale. Addition of KCl to the sample resulted in the appearance of the peak at 200 nm, which appeared in the fractions as well. The spectrum obtained with Mainstream water after addition of KCl exhibited a slow decline in absorbance with increasing wavelength. This is unlike most of the fractions which showed a fairly constant absorbance with increasing wavelength, particularly above 400 nm.

On May 27 a sample of groundwater was collected from the well ES9, which is outside the plume. This sample was filtered, loaded and chromatographed in the same manner as the ES16 sample, except for the increased volume of 0.1 M HCl used for elution. The UV chromatogram is shown in Figure 3.18. It shows some features that are similar to the chromatogram in Figure 3.17, although the intensities of the peaks are different. There are broad peaks in the second KCl gradient and 0.5 M KCl, as well as in the 0.1 M HCl. The two peaks in the first KCl gradient have retention times similar to peaks 1 and 4 from the ES16 sample. The HCl gradient also gave a sharp peak like the one in Figure 3.17.

UV absorbance spectra of the fractions from the ES9 run were measured and the spectra are shown in Appendix 4. With this sample the peaks in the UV chromatogram that eluted in KCl were due to a broad increase in UV absorbance across the spectrum. This is similar to what was observed with the ES16 sample. In this case the broadening of the peak at 200 nm in fraction 65 is not so apparent. The fractions that eluted in HCl show evidence of broad peaks around 240 and 340 nm, which is similar to the same fractions from the ES16 sample.

Co-60 CPM/kg loaded
ES16, Apr 22, run # 3, May 07

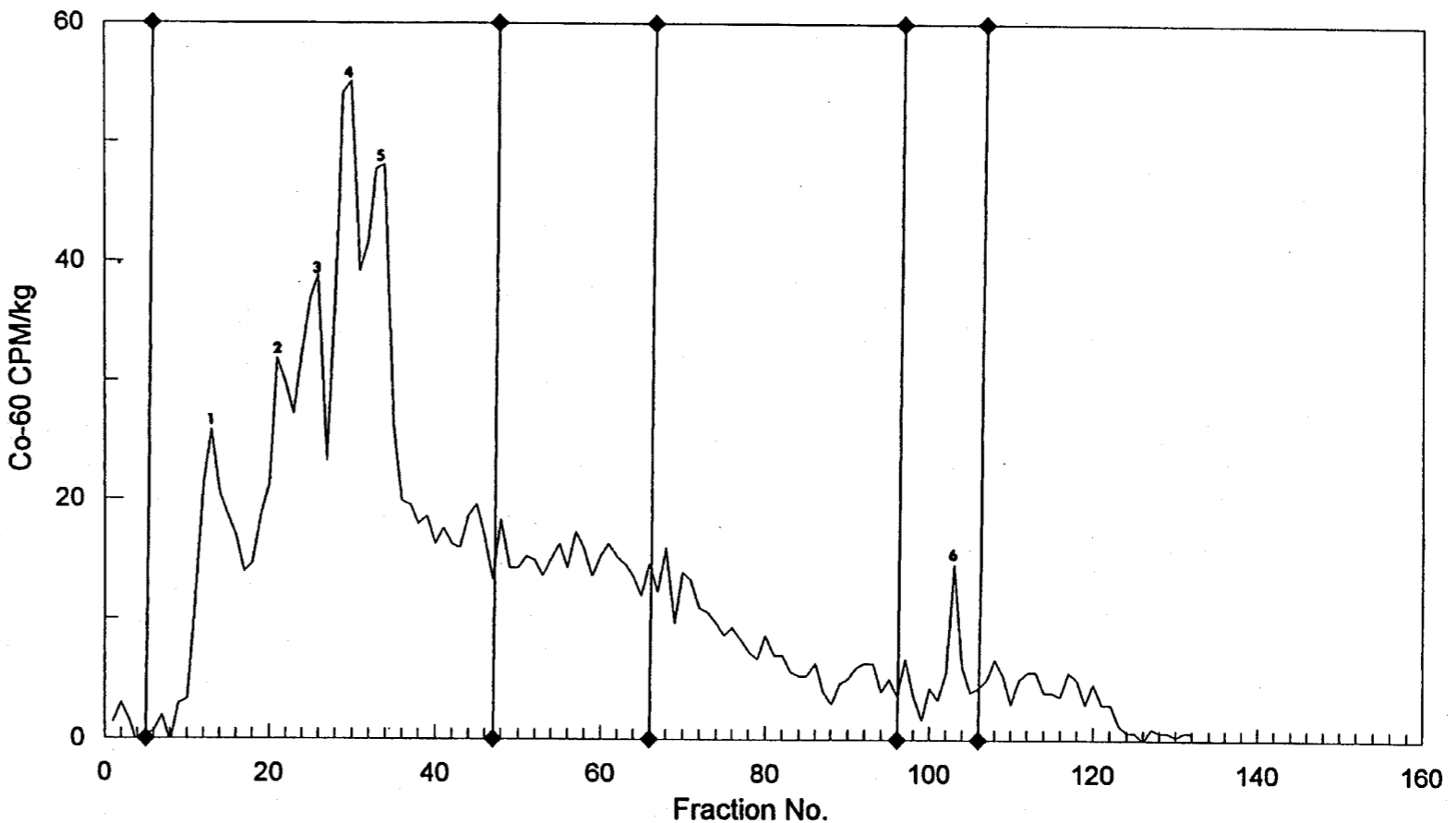

Vertical lines show eluent changes

Figure 3.15 Cobalt-60 chromatogram for well ES16 April 22, 1996 sample

ES16, August 17, 1993 - Co-60 CPM/L

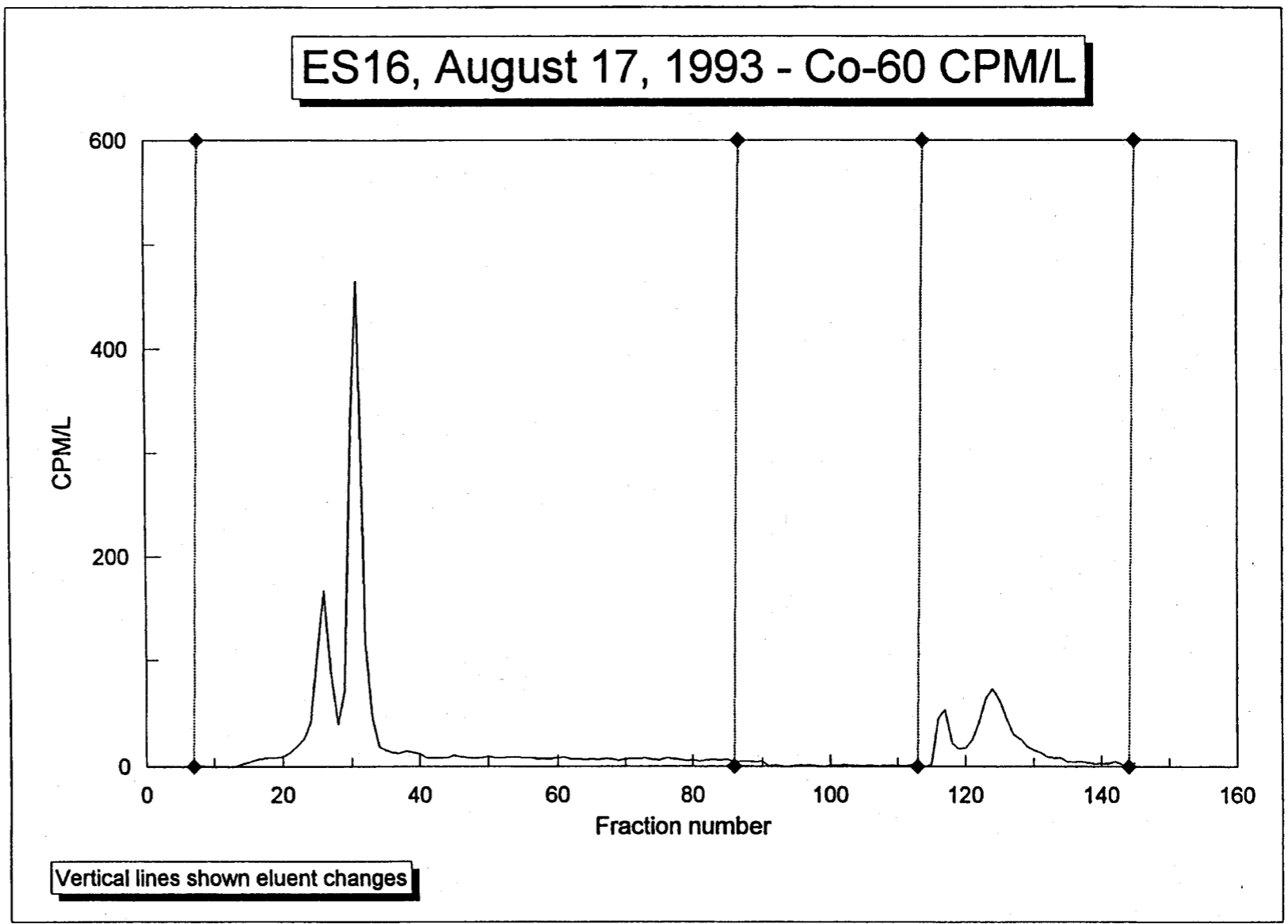
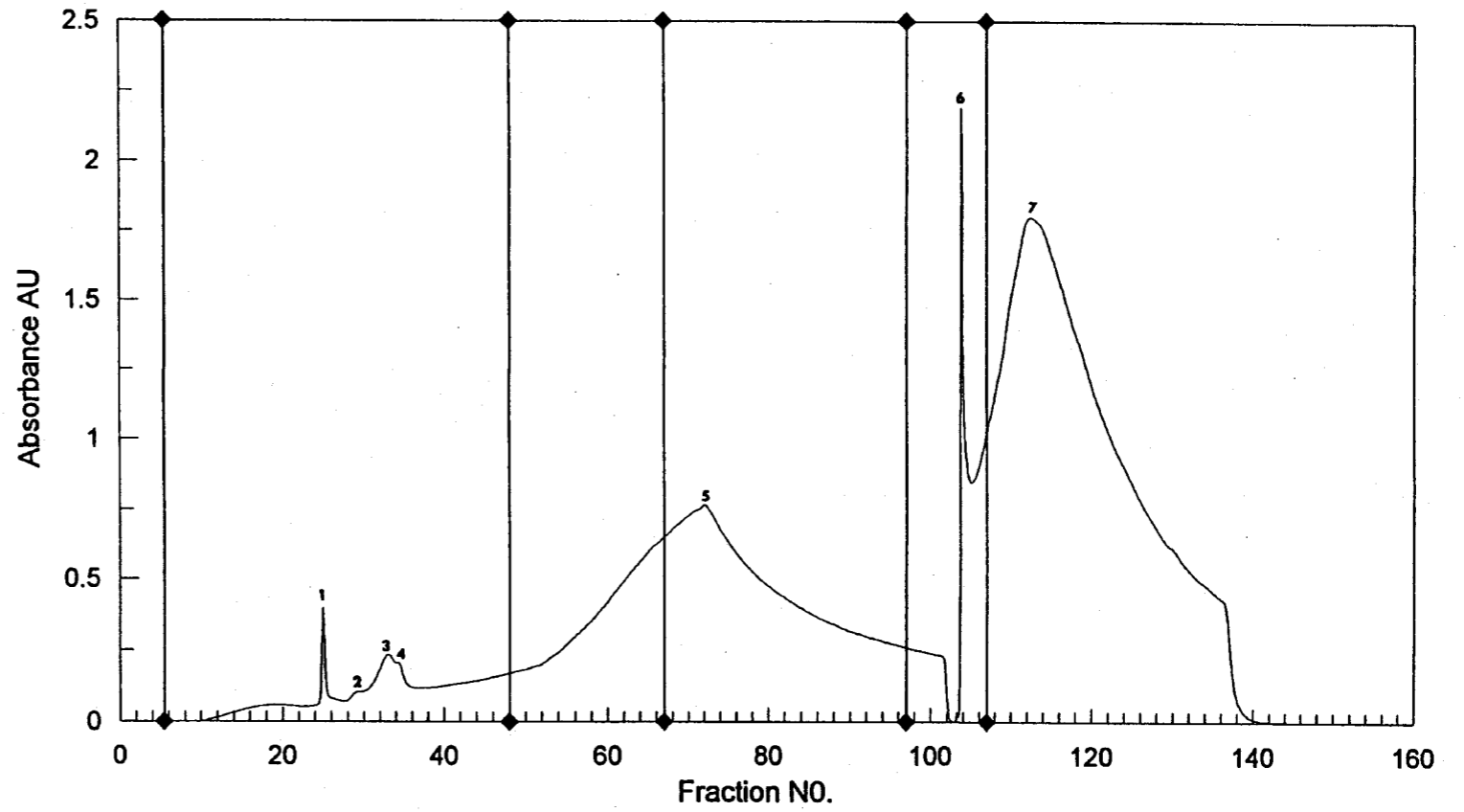

Figure 3.16 Cobalt-60 chromatogram for well ES16 August 17, 1993 sample

UV Absorbance at 254 nm

ES16, Apr. 22, run # 3, 1996 May 7



Vertical lines show eluent changes

Figure 3.17 UV absorbance chromatogram for well ES16 April 22, 1996 sample

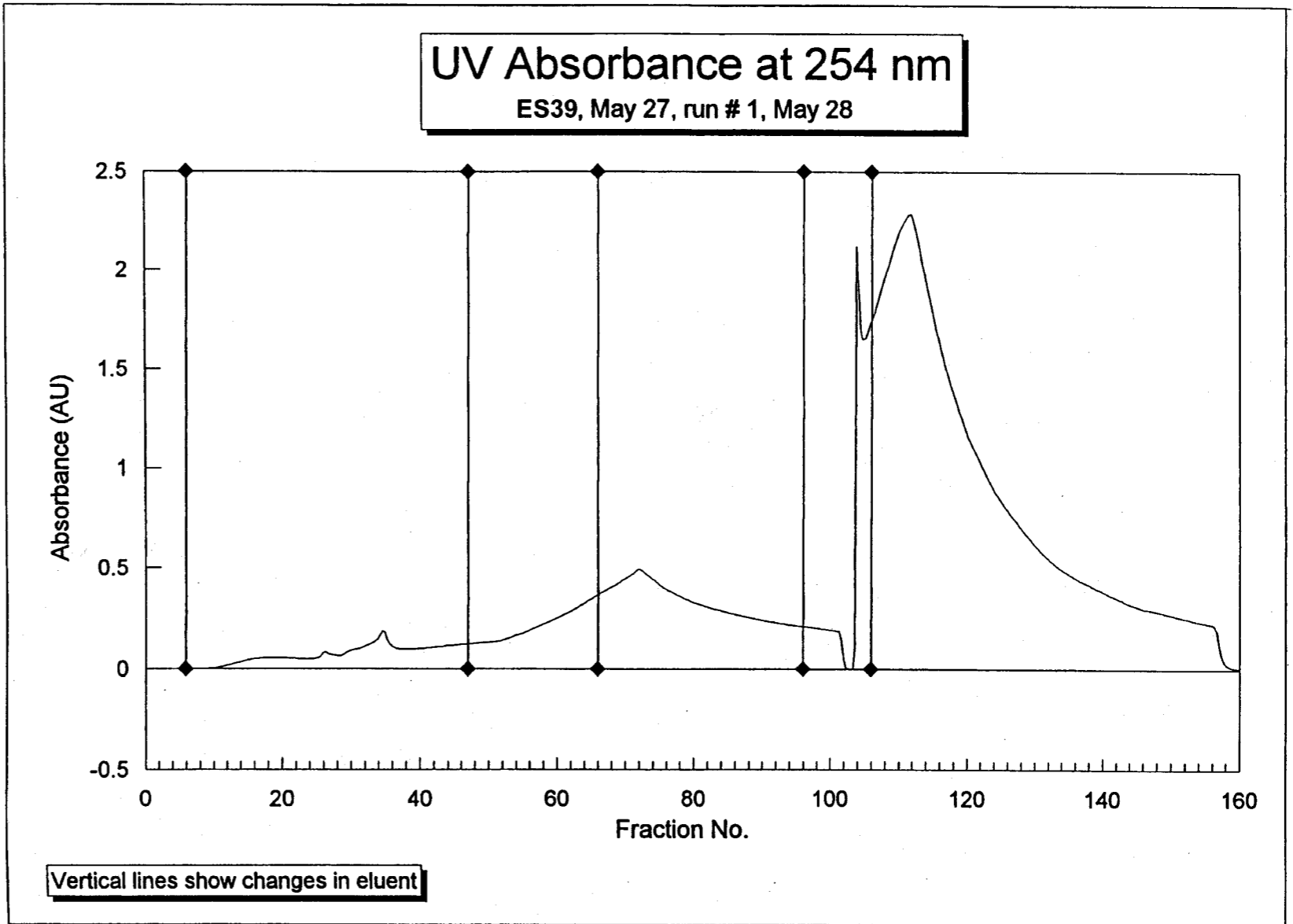

Figure 3.18 UV absorption chromatogram for well ES9 May 27, 1996 sample

On May 13, 1996 another sample of ES16 groundwater was pumped and filtered. Five portions of this sample were loaded onto anion exchange resin and chromatographed between May 14 and May 23. The UV chromatograms, shown in Figures 3.19 and 3.20, showed good consistency in shape and peak retention times from run to run. The chromatograms were similar to the one in Figure 3.17. There were four peaks in the first KCl gradient, one broad peak in the second KCl gradient and 0.5 M KCl, and two peaks in HCl. The first narrow peak in HCl seemed to decline between the first and second runs, while the second, broad peak increased in the later runs.

The fractions from the first two runs were analysed for ^{60}Co using the MINAXI9 counter and the chromatograms are shown in Figure 3.21. They were similar to the chromatogram of the earlier ES16 sample shown in Figure 3.6. Six peaks could be identified in the chromatograms. Five were in the first KCl gradient, while the sixth was in the HCl gradient. Selected fractions from the May 15 run were also analysed on the high resolution spectrometer. These spectra gave results for ^{137}Cs and ^{60}Co , which are shown in the chromatograms in Figure 3.22. In earlier work it was also possible to construct chromatograms for ^{106}Ru , but in 1996 the concentration has declined to the point where the peaks from ^{106}Ru could no longer be identified in the spectra from the fractions.

The chromatogram for ^{137}Cs had a peak which eluted in the first KCl gradient. This confirmed the presence of unique anionic ^{137}Cs species, which had been detected when anionic/cationic speciation had been measured with cation and anion resins in samples collected early in 1996. The chromatograms for the two ^{60}Co peaks confirmed the one obtained earlier with results from the MINAXI9 counter.

In summary, the anion chromatography separations of ^{60}Co have provided results very similar to those observed for the ultra-

filtered groundwater samples (see Section 3.2.2), and confirm the presence of multiple soluble anionic species of organo-radionuclide complexes existing in groundwater. These results also confirm the similar observations reported earlier for this groundwater plume (Cooper and Mattie, 1993; Cooper, Haas, and Mattie, 1995).

3.4 Adsorption of Anionic and Cationic Radionuclide Species onto Soil

Previous large-volume groundwater sampling and radionuclide analyses have shown that anionic chemical species of a large suite of radionuclides are transported most rapidly in the subsurface saturated environment. In order to more accurately predict the "first arrival" transport rates (and conversely, the retardation) of the mobile anionic radionuclide species in groundwater, a series of Kd measurements were conducted using as tracers: 1) natural anionic radionuclide species isolated from well ES16 groundwater, and 2) for comparison purposes, commercially available cationic species of radioisotopes (see Section 2.5). The results of these sorption experiments are described in this section.

3.4.1 Groundwater Characterization

Groundwater sampled from well ES16 was characterized for radionuclide chemical speciation and elemental composition. The ambient concentrations of radionuclide contaminants in ES16 contaminated groundwater (see Table 3.5) were substantially lower than those observed in previous samplings [Champ et al., 1984; Cooper and Mattie, 1993]. The radionuclide chemical speciation in the original contaminated groundwater from ES16 was generally consistent with the previous sampling episodes as well, except perhaps for ^{137}Cs , which showed a dominant anionic character (Figure 3.23, top). It was not known whether this was

representative of the groundwater, as the total was ~1050 pCi/L and the concentration of the anionic species was 250 pCi/L. The concentrations of Co-57, Nb-94 and Cs-134 in this groundwater sample were very low. The levels of these three nuclides were fairly close to the detection limits, and these values were

negligible compared to the amount of spikes used, thus these small amounts do not affect the speciation results. These initial values were subtracted when sorption values were calculated. The concentration of all radionuclides were below detection limits in ES9 (uncontaminated groundwater).

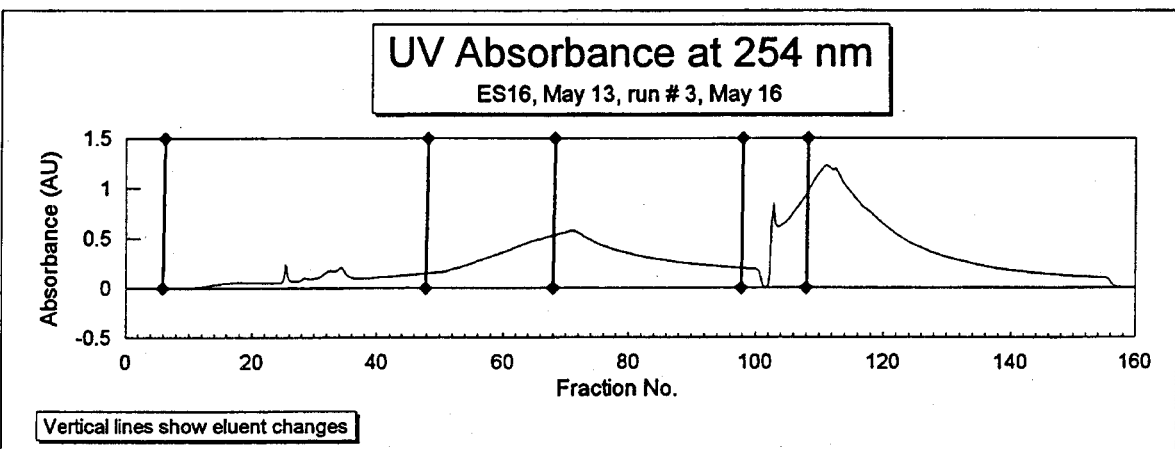
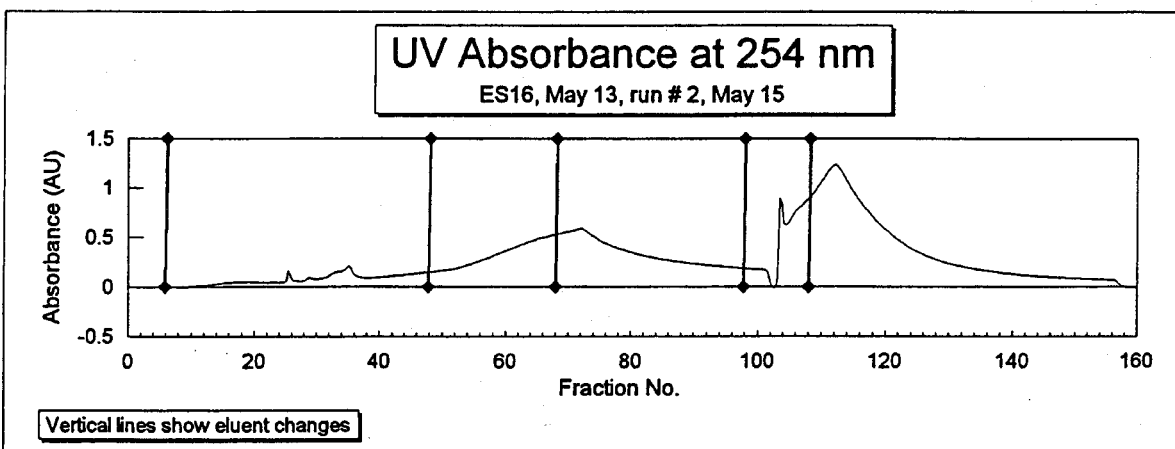
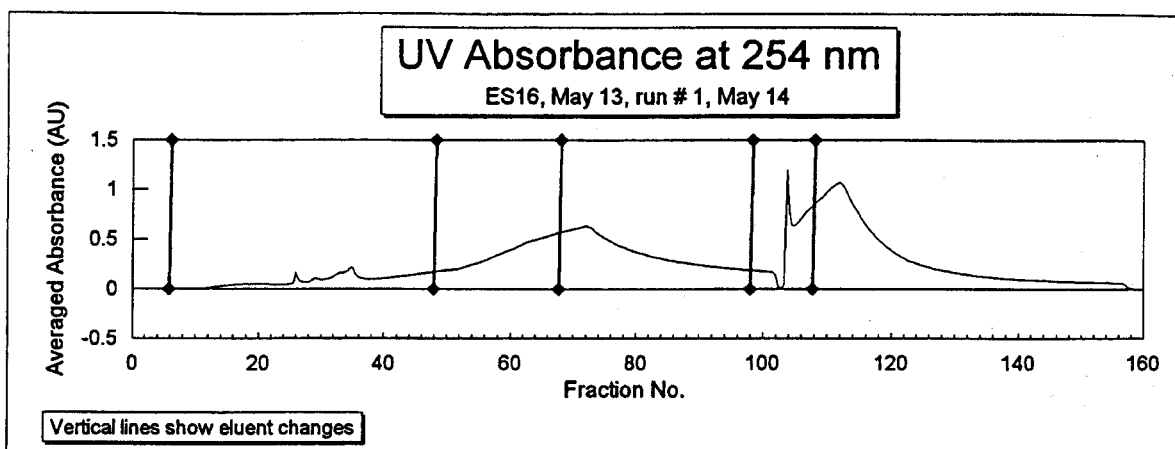

Figure 3.19 UV absorbance chromatograms for successive runs of May 13, 1996 samples from well ES16

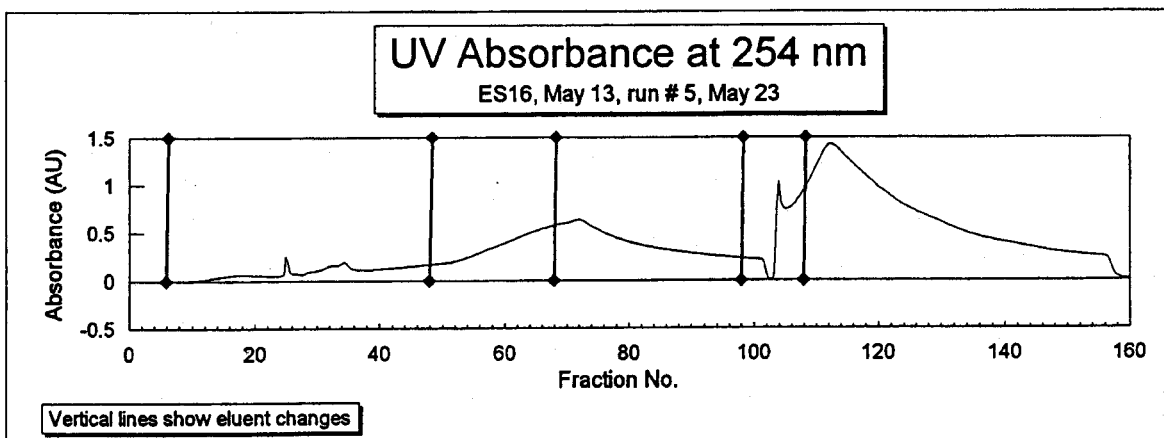
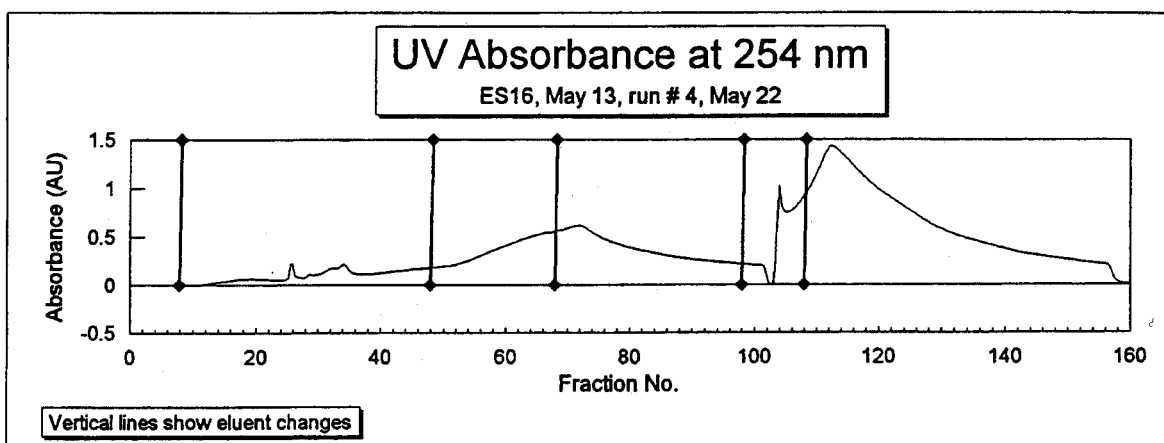

Figure 3.20 UV absorbance chromatograms for successive runs (continued)

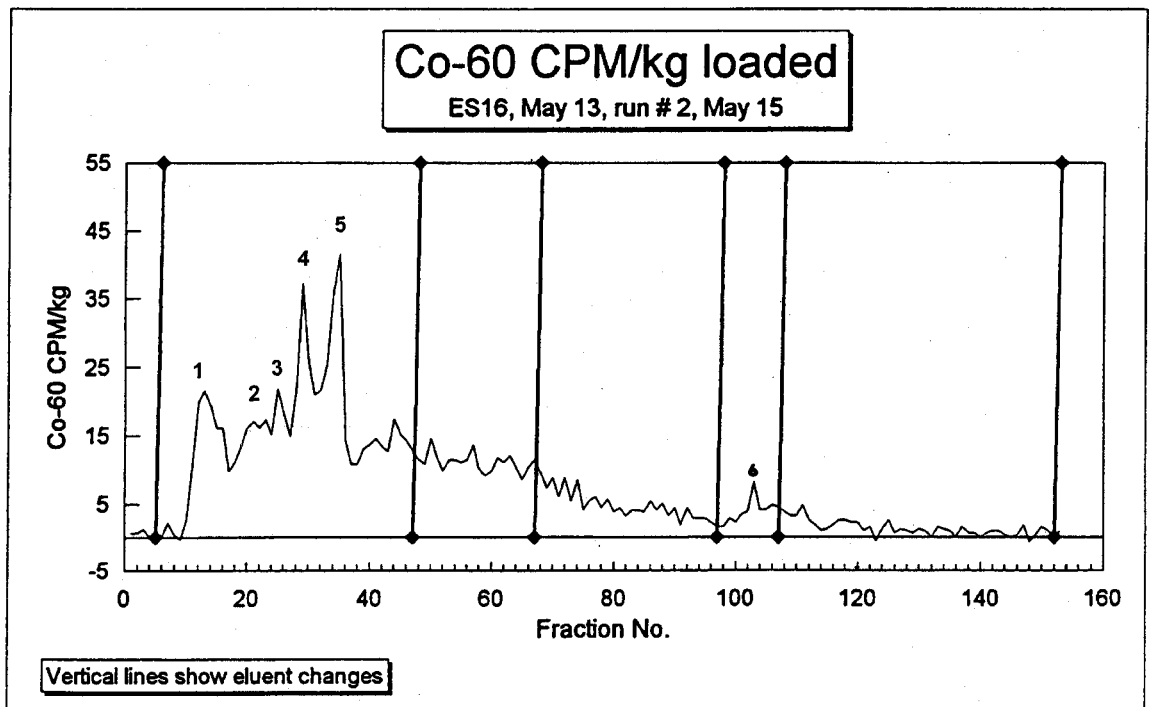
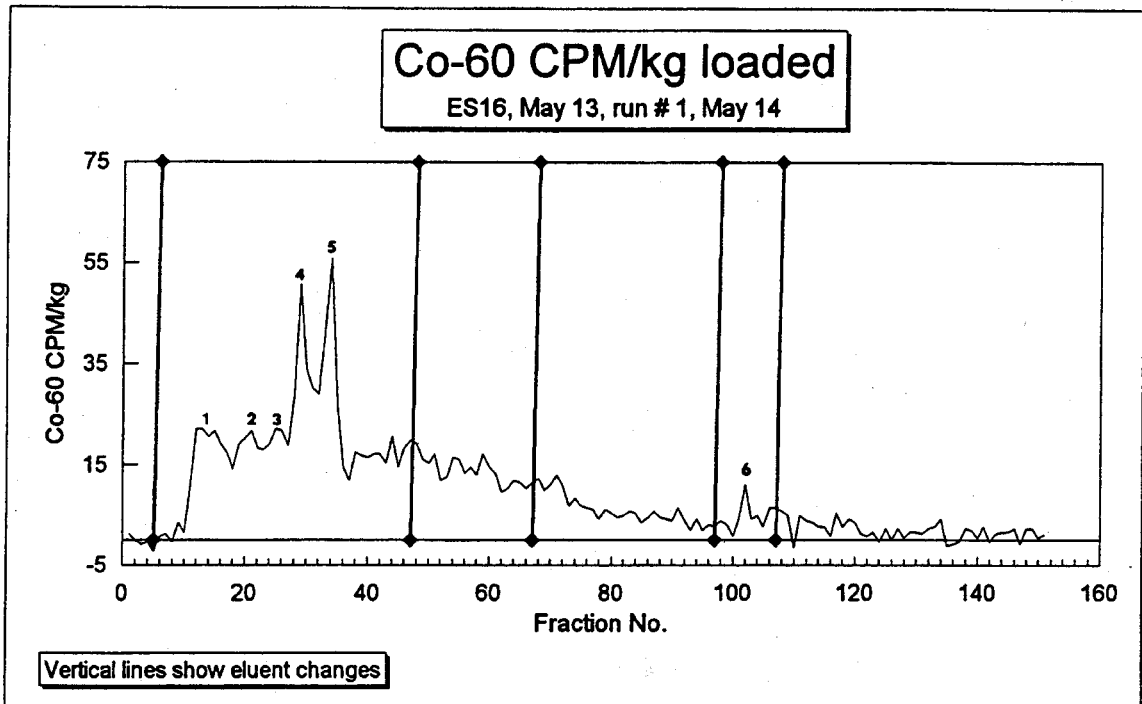
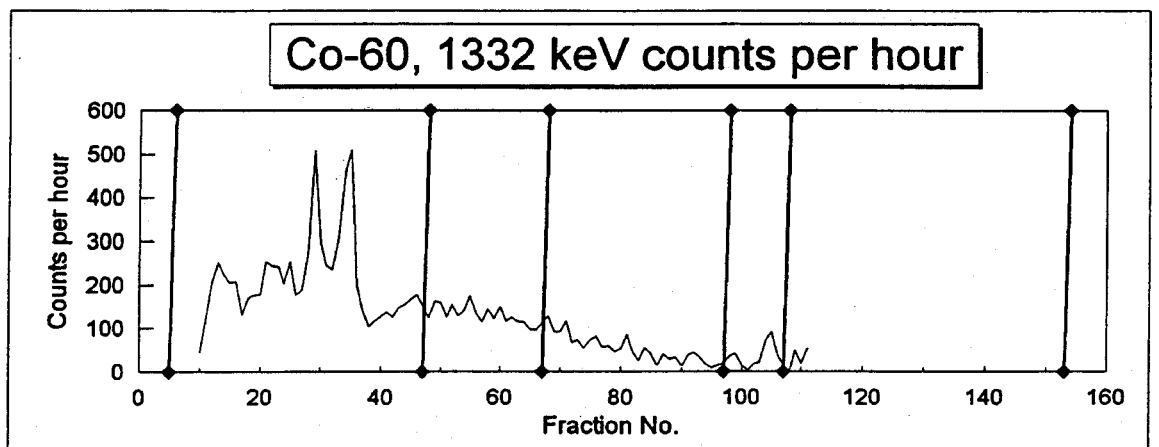
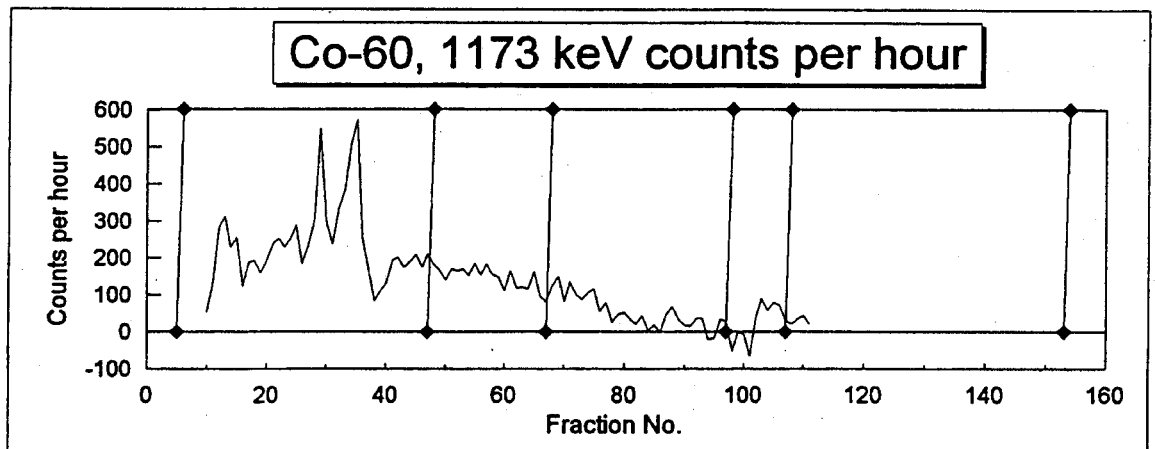
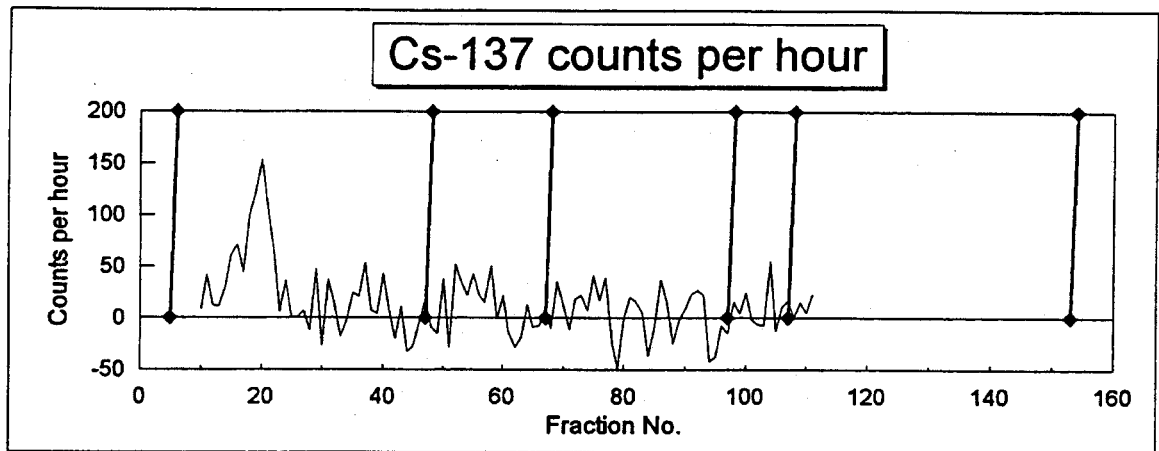

Figure 3.21 Cobalt-60 chromatograms for successive runs



Vertical lines show changes in eluent

Figure 3.22 Cs-137 and Co-60 chromatograms for well ES16 1996 May 5 sample

Table 3.5 Levels of radionuclides present in contaminated and uncontaminated groundwaters (measured), and levels of artificial tracers added to each solution (calculated).

Radionuclide	ES16 contaminated groundwater (June 1996 sampling)			ES9 uncontaminated groundwater	
	Initial amount reported (pCi/L)	tracer added (pCi/L)	detection limit (pCi/L)*	tracer added (pCi/L)	detection limit (pCi/L)**
Co-60	3080		~1.9		11-65
Ru-106	460		11-54		140-810
Cs-137	1050		4.0-8.0		11-95
Pu-238	38		~0.05		0.3
Pu-239	184		~0.05	1.02E4	0.3
Am-241	5.4		5-50 (γ) [†] ~0.05 (α) [‡]	9,530	35-110 (γ) [†] 0.3 (α) [‡]
Cm-244	0.54		~0.05		0.3
Artificial tracers					
Co-57	4.1	1.42E4	~2.7	5.3E4	~8
Nb-94		8,210	2.7-5.4	5.68E4	~11
Cs-134	2.9	8370	1.4-14	5.43E4	1.4-54

*Based on a 1 L sample and a 3 h count for the gamma emitters, and a 16 h count for the alphas.

**Based on a 0.2 L sample and a 3 h count for the gamma emitters, and a 6 h count for the alphas.

†Based on gamma spectrometry.

‡Based on alpha spectrometry

Speciation checks: after cation exchange processing ("anionic" species)

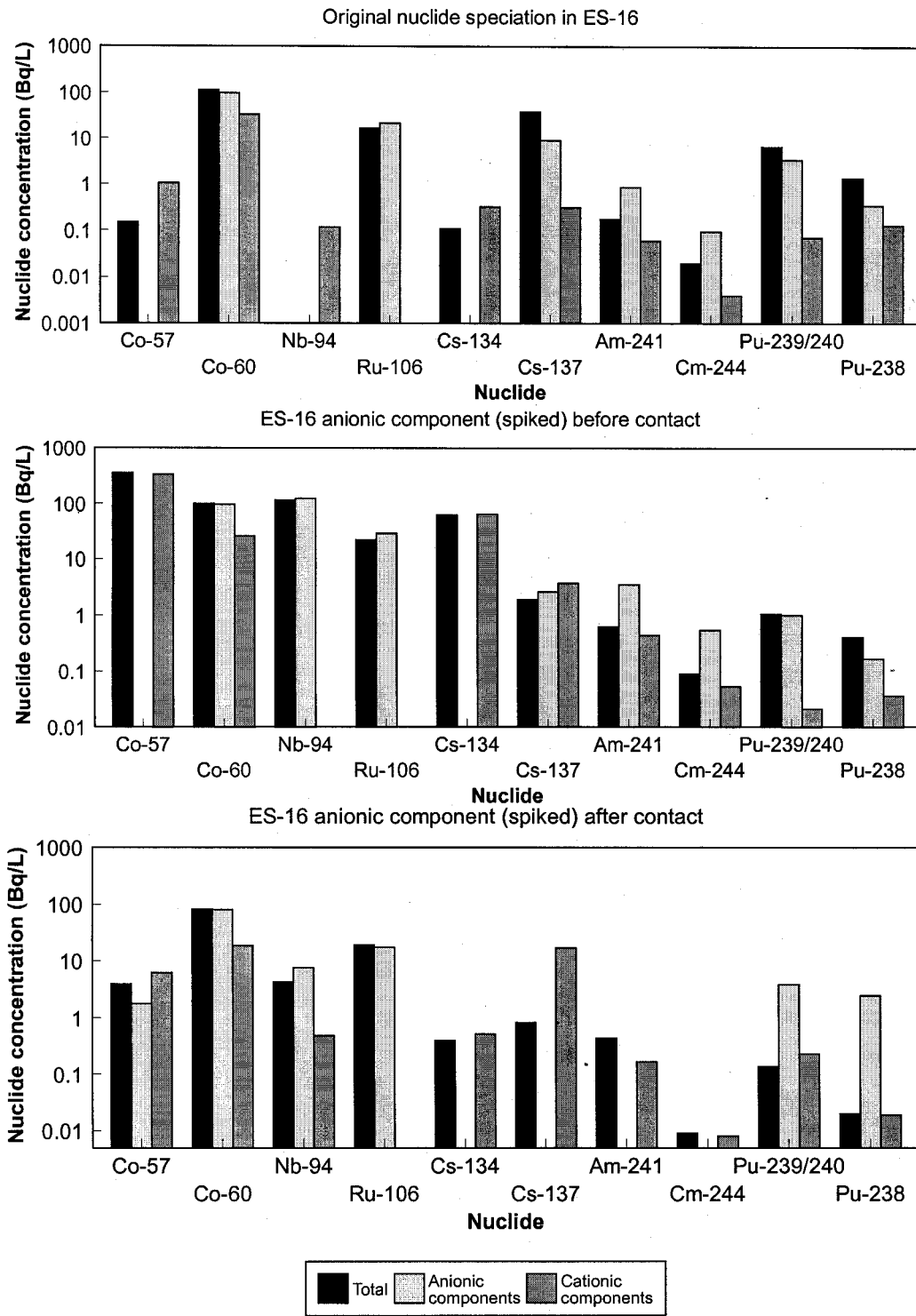

Figure 3.23 Speciation of nuclides and tracers in contaminated groundwater (from well ES16) before and after pretreatment through a cation exchange resin

Tables 3.6 and 3.7 show the groundwater major ion chemistry of the ES-16 and ES-9 samples, respectively, at various stages of sample manipulation. The total concentration of ions, before contacting with sand, was ~1200 $\mu\text{Eq/L}$ for both ES-16 and ES-9 samples, whereas the nanofiltered sample total ionic content decreased to ~230 $\mu\text{Eq/L}$. The ion concentrations increased by ~5 to 20% after the groundwater had equilibrated with the sand, except for Cl^- ion, which increased by ~200-300%. The total ion concentrations increased from ~230 to 740 $\mu\text{Eq/L}$ in the nanofiltered sample after contact with sand. Additions of radiotracers, dissolved in acids, increased the anion levels by ~9 $\mu\text{Eq/L}$ (ES16 samples) and ~120 $\mu\text{Eq/L}$ (ES9 samples). The pH did not change appreciably after addition of tracers (see Tables 3.6 and 3.7; the pH values should be compared to "after ion exchange processing"), and the changes in dissolved ions probably did not affect sorption, assuming that ion exchange was the main mechanism controlling sorption. In fact, the sand has a cation exchange capacity (CEC) of ~1.2 mEq/100 g [Jackson and Inch, 1983], which exceeds the total cations present in each flask by a factor of about five², or more in the case of the nanofiltered solution. The additions of ions from the spikes would not exceed the sand exchange capacity.

3.4.2 K_d Measurements Using Cationic and Anionic Radionuclide Species

Table 3.8 shows the sorption results obtained for the various types of groundwater sample treatment. The 1σ refer to the standard deviation among replicate measurements, except for $^{239/240}\text{Pu}$ and $^{241}\text{Am}(\alpha)$ in ES9 uncontaminated groundwater, where two separate measurements are listed. The values obtained with ^{57}Co , ^{94}Nb and ^{134}Cs for all the samples, plus $^{239/240}\text{Pu}$ and ^{241}Am for the ES9 samples, in principle, should be equivalent for

² For example, in the sorption experiments, 200 g of sand were contacted with 800 mL of solution. The sand has a total capacity of 2.4 mEq (1.2 mEq/100g), and the solution has $0.8\text{ L} \times (1200\ \mu\text{Eq/L})/2$ for the cations, for a total content of ~0.48 mEq, or an excess exchange capacity of ~5.

all types of sample pre-treatments, because the radiotracers were all added at the last step prior to equilibration with the sand. The values obtained for the contaminants in ES16 (^{60}Co , ^{106}Ru , ^{137}Cs , ^{238}Pu , $^{239/240}\text{Pu}$, ^{241}Am and ^{244}Cm) represent the K_d 's for the separate species ("cationic" and "anionic") present in the contaminated plume.

This experiment demonstrated quite convincingly that the K_d values of the nuclides present in the contaminated aquifer (Co, Cs, Pu, Am), were much smaller than the K_d values determined with commercial tracers of the same elements, on the same geological material. The difference in K_d values determined by the two sets of tracers was about 2-3 orders of magnitude for Cs, up to 2 orders of magnitude for Co and Am, and at least a factor of ~5 to ~30 for Pu. Niobium-94 was not detected in the ES16 groundwater after anionic pre-treatment, so the commercial tracer results cannot be compared to a natural aquifer value. The high sorption value for Nb was not surprising [Ticknor et al., 1996; Caron, unpubl.]. Two determinations each using Pu and Am commercial tracers are listed in Table 3.8 for ES9, as only two values of the triplicates were available. This large experimental variability would lead to relatively high 1 sigma uncertainties for the average K_d values.

The levels of nuclides in the cationic fraction were detectable for only two nuclides, Co and Cs. The K_d for cationic Co was 5.5, versus 0.8 for the anionic form of the element, whereas the "less than" value reported for Cs would suggest similar K_d values. These values are still well below the K_d 's obtained with the commercial tracers for these radionuclides. The K_d values obtained with the commercial tracers added to the solutions, were in the same range as other values obtained for CRL sand in a separate study (Table 3.9), although our values are significantly lower than those reported by Ticknor et al. [1996] for Co. The values are comparable to the recommended values for a low-level radioactive waste (LLRW) near-surface disposal concept at CRL (Caron, 1995). Although the range obtained with the four different measurements with the tracers is large (~1 order of magnitude difference), these values are clearly higher

than the K_d 's measured for the same elements (Co, Cs, Pu and Am) present in the plume. The case is not so clear for Co, for which *in situ* K_d values ranged from 0.5 to 130 mL/g in the sandy material of the same plume [Killey et al., 1984]; the values of the current study (contaminated groundwater versus added tracer) are at both ends of this range.

The variations of K_d values obtained with the spikes in the four measurements do not appear to be related to the sample pre-treatment. One would expect that nanofiltration with the RO unit (200 Daltons

NMWCO) would remove colloidal material and some high molecular weight organics, both of which contribute to keeping radionuclides in solution or suspension, and this would effectively give a lower sorption value than the "true" one. However, this is not the case, and it suggests that high molecular weight organics and/or colloidal matter did not play an important role in sorption, at least for the duration of this experiment.

Table 3.6 Concentrations of major ions in ES16 contaminated groundwater at various stages of sample processing.

Ion	Concentration Increase after Tracer addition	ES16 contaminated groundwater composition (all concentrations in mg/L)						
		Original filtered groundwater	After cation exchange resin step			After anion exchange resin step		
			Column Eluent	before equilibration	after equilibration	column eluent	before equilibration	after equilibration
Ca ²⁺		1.72	ND	0.60	0.58	1.72	1.73	3.60
Fe ³⁺		1.56	0.58	0.35	0.07	ND	ND	ND
K ⁺		1.40	0.50	0.30	1.20	1.70	1.70	2.50
Mg ²⁺		0.72	ND	ND	0.16	0.74	0.72	1.00
Na ⁺		6.80	13.90	13.60	13.60	6.70	6.80	9.00
Si		5.80	5.70	5.70	6.20	5.60	5.70	6.70
F ⁻	0.01	0.28	0.31	0.29	0.35	0.05	0.06	0.10
Cl ⁻	0.1	1.25	1.32	1.32	3.12	24.95	24.15	26.01
NO ₃ ⁻	0.4	0.26	0.48	0.10	0.35	ND	ND	0.15
SO ₄ ²⁻		8.46	8.72	8.77	14.80	ND	ND	4.48
DIC (as C)		5.09	5.07	3.90	1.98	0.09	0.07	0.27
DOC (as C)		4.17	3.49	4.03	5.03	9.80	9.67	10.47
PH	7.31† 4.14‡	6.28	6.80	6.88	7.34	4.13	4.19	5.97

†To be compared to eluent from the cation exchange resin step.

‡To be compared to eluent from the anion exchange resin step.

Table 3.7 Concentrations of major ions in ES9 uncontaminated groundwater at various stages of sample processing

Ion	Conc. Increase after tracer Addition	ES9 uncontaminated groundwater composition (all concentrations in mg/L)								
		Ion exchange processing (for blanks purposes)			K _d determination "conventional batch" method			K _d determination, after reverse osmosis processing "nanofiltered batch" method		
		Original filtered	after cation exchange	after anion exchange	Original filtered	before contact	after contact	Original nanofiltered	before contact	after contact
Ca ²⁺		4.90	0.09	4.80	4.80	4.80	3.30	0.75	0.99	1.49
Fe ³⁺		2.00	1.77	0.01	1.89	1.74	0.07	0.02	0.03	0.01
K ⁺		1.90	0.35	1.40	1.50	1.30	1.90	0.60	1.30	1.50
Mg ²⁺		1.88	ND	1.86	1.90	1.88	1.06	0.46	0.52	0.44
Na ⁺	0.1	2.12	12.50	2.04	2.04	2.00	4.50	1.18	1.38	5.50
Si		7.40	6.40	7.20	7.70	7.70	8.00	4.50	4.30	5.40
F ⁻	0.1	0.08	0.09	0.07	0.09	0.07	0.16	0.06	0.08	0.11
Cl ⁻	2.1	1.43	1.24	26.31	1.13	1.23	2.68	0.73	0.86	4.66
NO ₃ ⁻	3.3	0.08	0.10	ND	0.06	ND	0.13	0.12	0.08	3.41
SO ₄ ²⁻		10.39	8.97	ND	10.42	10.39	14.89	2.95	2.89	8.28
DIC (as C)		3.28	3.09	0.27	2.77	4.33	1.30	0.74	0.47	0.16
DOC (as C)		5.32	5.51	17.60	4.84	3.11	3.38	1.74	1.40	1.57
pH	6.85† 6.69‡	6.88	7.52	4.22	6.79	6.89	7.02	6.10	6.45	6.49

†To be compared to "batch K_d determination, before contact".

‡To be compared to "nanofiltered batch, before contact"

Table 3.8 K_d values obtained for the ambient radionuclides and the tracers for the different sample manipulations

Nuclide	Sample source and treatment							
	Contaminated GW from ES16, after cation exchange (anionic components)		Contaminated GW from ES16, after anion exchange (cationic components)		Uncontaminated GW from ES9, spiked w/ tracers, Batch sorption (unaltered GW)		Uncontaminated GW from ES9, spiked w/ tracers, Batch sorption (nanofiltered GW)	
	K_d	$\pm 1 \sigma$	K_d	$\pm 1 \sigma$	K_d	$\pm 1 \sigma$	K_d	$\pm 1 \sigma$
^{60}Co	0.8	0.1	5.5	0.2				
^{106}Ru	0.7	1.0						
^{137}Cs	5.3	6.2	<8.6	-				
^{238}Pu	25	23						
$^{239/240}\text{Pu}$ 1	25	20			844			
$^{239/240}\text{Pu}$ 2					120			
^{241}Am (γ)*					>737	-	>505	-
^{241}Am (α)* 1	1.8	0.6			956			
^{241}Am (α)* 2					189			
^{244}Cm	37	38						
Artificial tracers								
^{57}Co	352	10	32.8	5.4	>31.4	-	122	5
^{94}Nb	103	5	1250	180	439	226	2440	270
^{134}Cs	>635	-	>850	-	3820	1760	580	42

NOTE: Blank spaces mean that K_d was not determined because the detection limits have been reached, or the radioisotope was not present. A "-" means "not applicable". The shaded areas indicate that these results are not available at the time the report was written.

*: Am (γ) means that K_d was determined using the gamma results, Am (α) is based on alpha measurements.

1, 2: K_d determined by two different calculations using the same C_0 in Eq. (2) and two C_{eq} from two duplicate solutions that gave inconsistent results.

Table 3.9 Comparison of values obtained in this work with ES16 groundwater (pre-treated with cation exchange resin to isolate the anionic species) and with artificial tracers vs. other works.

Element	K _d (mL/g)			
	This work, contaminated plume (anionic species)	This work, "batch" with commercial tracers	Ticknor et al. [1996]*	Compiled databases for sand**
Am	1.8	159-956	-	1900 ^(A,B)
Cm	37	-	-	4000 ^(B)
Co	0.8	~32-352	638; 982 (n = 2)	60 ^(A,B)
Cs	5.3	580-3820	2490; 2450 (n = 2)	280 ^(A,B)
Nb	-	103-2440	892; 740 (n = 2)	750 ^(A)
Pu	25	120; 844	306 - 563 (n = 4)	550 ^(A,B)
Ru	0.7	-	-	55 ^(B)

*Ticknor et al. [1996]: values obtained experimentally with CRL sand.

**Compiled databases: A, [Caron, 1995]; B, [Sheppard and Thibault, 1990]

3.4.3 Speciation Checks During K_d Measurements

Figures 3.24 to 3.28, show the nuclide speciation for the different sorption experiments before and after equilibration with CRL sand. Figures 3.27 and 3.28 show the speciation in ES16 and ES9 groundwater, respectively, for the solutions stored under ambient room conditions (in the dark) for a 7-day period, which was the same duration as the equilibration with sand. The initial speciation of the radionuclides is also shown in ES16 contaminated groundwater. In all situations, the artificial tracers ⁵⁷Co and ¹³⁴Cs were almost exclusively cationic, whereas ⁹⁴Nb, ^{239/240}Pu and ²⁴¹Am were mostly anionic. Among the species initially present in the contaminated plume, ⁶⁰Co, ²³⁸Pu, ^{239/240}Pu, ²⁴¹Am and ²⁴⁴Cm were mostly anionic, only negative species of ¹⁰⁶Ru have been detected, and ¹³⁷Cs had a strong anionic component, which is unusual. These speciation results are consistent with previous studies done at CRL [Killey et al.,

1984; Cooper and McHugh, 1983; Cooper and Mattie, 1993; Champ and Robertson, 1986; Champ et al., 1985].

After treatment with the cation exchange resin, and upon equilibration of contaminated ES16 groundwater with CRL sand (Fig. 3.23), ⁶⁰Co, ¹⁰⁶Ru, ²⁴¹Am and ²⁴⁴Cm retained their initial relative speciation, whereas the ¹³⁷Cs relative speciation had shifted to display approximately the same amount between total, anionic and cationic species, just before equilibration. The Pu speciation results were unclear; their relative speciation seemed consistent, but the Pu levels dropped significantly after the ion exchange step.

After treatment with the anion exchange resin, the ¹⁰⁶Ru and the anionic ¹³⁷Cs levels dropped below detection limits. The negative ¹³⁷Cs species were not detected after equilibration with sand.

In Figure 3.24, a significant proportion of ⁶⁰Co decreased, especially the anionic species, which dropped from 2620 to 324 pCi/L, after treatment with anion exchange resin. It remained at ~324 pCi/L after equilibration. It

is unclear whether the small K_a observed for Co (5.5 mL/g) could be attributable to cationic or neutral species present in the "cationic fraction". One would expect that cationic species, if present, would exhibit a much higher K_a value.

The speciation results were as expected for the "conventional batch" and "conventional batch-nanofiltered" experiments for ^{57}Co , ^{94}Nb , ^{134}Cs , and $^{239/240}\text{Pu}$ (Figs 3.25 and 3.26). The results for ^{241}Am were more ambiguous, showing the predominance of anionic species before equilibration (Fig. 3.25) and the predominance of cationic species after equilibration.

The aqueous speciation in the solutions, stored under room conditions, did not change appreciably for the 7-day equilibration period (Figs. 3.27 and 3.28). In a few cases, a cationic or anionic component appeared for the Cs isotopes or ^{94}Nb , but this was insignificant compared to the total (note the log scales in the figures). The amounts of Am and Pu in ES-9 seemed to have increased after equilibration (Fig. 3.28); the reason for this anomaly is presently unknown.

In all experiments, the spiked tracers ^{57}Co , ^{94}Nb and ^{134}Cs were not detected in the initial solutions (except in the initial ES-16 solution), or their values were probably not significant, as they were close to the detection limit. These tracers were not detected after ion exchange processing. After addition of these spikes, both before and after equilibration,

almost all of the ^{57}Co and ^{134}Cs were cationic, whereas ^{94}Nb was anionic. In all cases after equilibration, the speciation of ^{60}Co was always different from that of ^{57}Co , which suggests that the ^{60}Co aqueous species were non-labile for the duration of the experiment, as no isotopic exchange seemed to have taken place. The data on ^{137}Cs was too limited and inconsistent to make a judgement.

Ruthenium was probably present in the groundwaters as RuO_4^- [Champ et al., 1984]. The case is unclear for Nb. E_H-pH diagrams suggest the dominance of the pentavalent oxidation ion, $\text{Nb}(\text{OH})_5^0$, which would become the negative species $\text{Nb}(\text{OH})_6^-$ at pH 7.4. Baes and Maesmer [1976] have mentioned that aqueous Nb species would be a pH-driven equilibrium between the polynuclear species $\text{Nb}_6\text{O}_{17}(\text{OH})_2^6-$, $\text{Nb}_6\text{O}_{18}(\text{OH})_7-$, and $\text{Nb}_6\text{O}_{19}^{8-}$. The polynuclear oxyl ion $\text{H}_x(\text{Nb}_6\text{O}_{19})^{8-x}(\text{aq})$ has also been listed (Cotton and Wilkinson, 1980; Baston et al., 1992; and references therein). It is suspected that this complex polymeric ion is the starting point of the formation of colloidal material. In a sand column experiment previously done at CRL (Caron, unpublished), small losses of Nb were observed, and the bulk of the Nb contacted with the column was essentially immobile. The calculated K_a was higher than 7800 mL/g.

Speciation checks: after anion exchange processing ("cationic" species)

Original nuclide speciation in ES-16

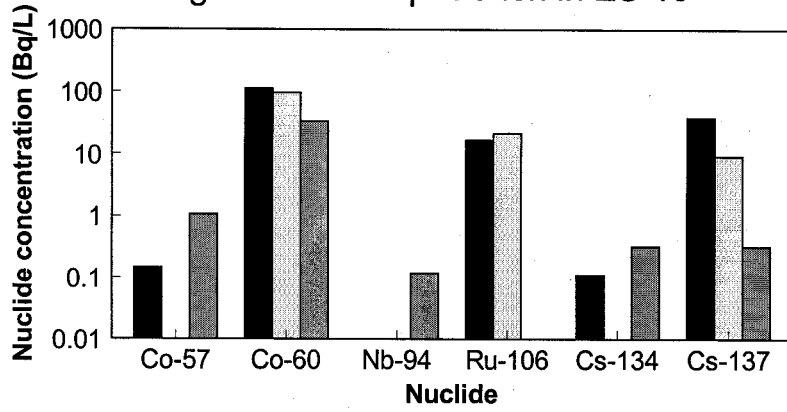

Nuclide speciation in ES-16 before equilibration

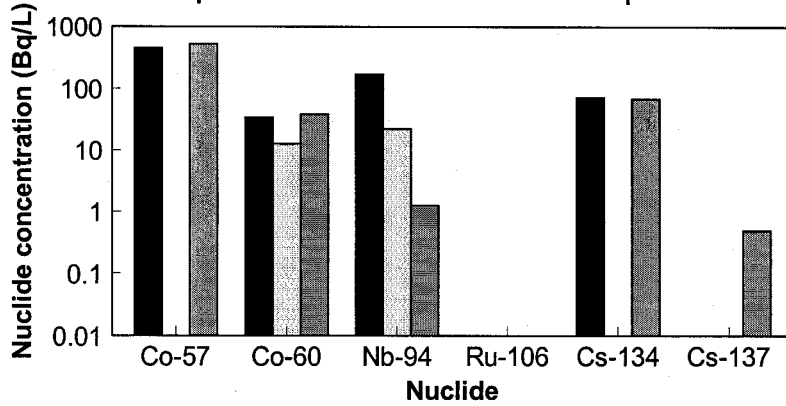

Nuclide speciation in ES-16 after equilibration

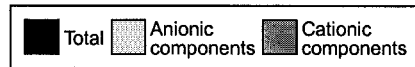
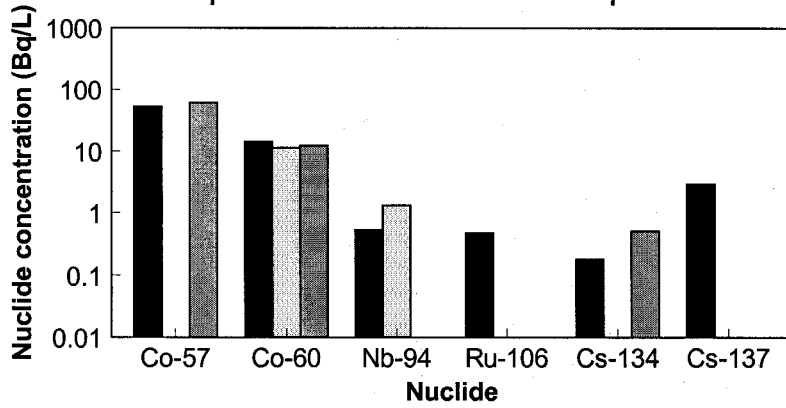

Figure 3.24 Speciation of nuclides and tracers in contaminated groundwater (from well ES-16) before and after pretreatment through an anion exchange resin column. The ^{57}Co , ^{94}Nb , and ^{134}Cs were the commercial tracers

Conventional "batch" K_d determination: unaltered groundwater

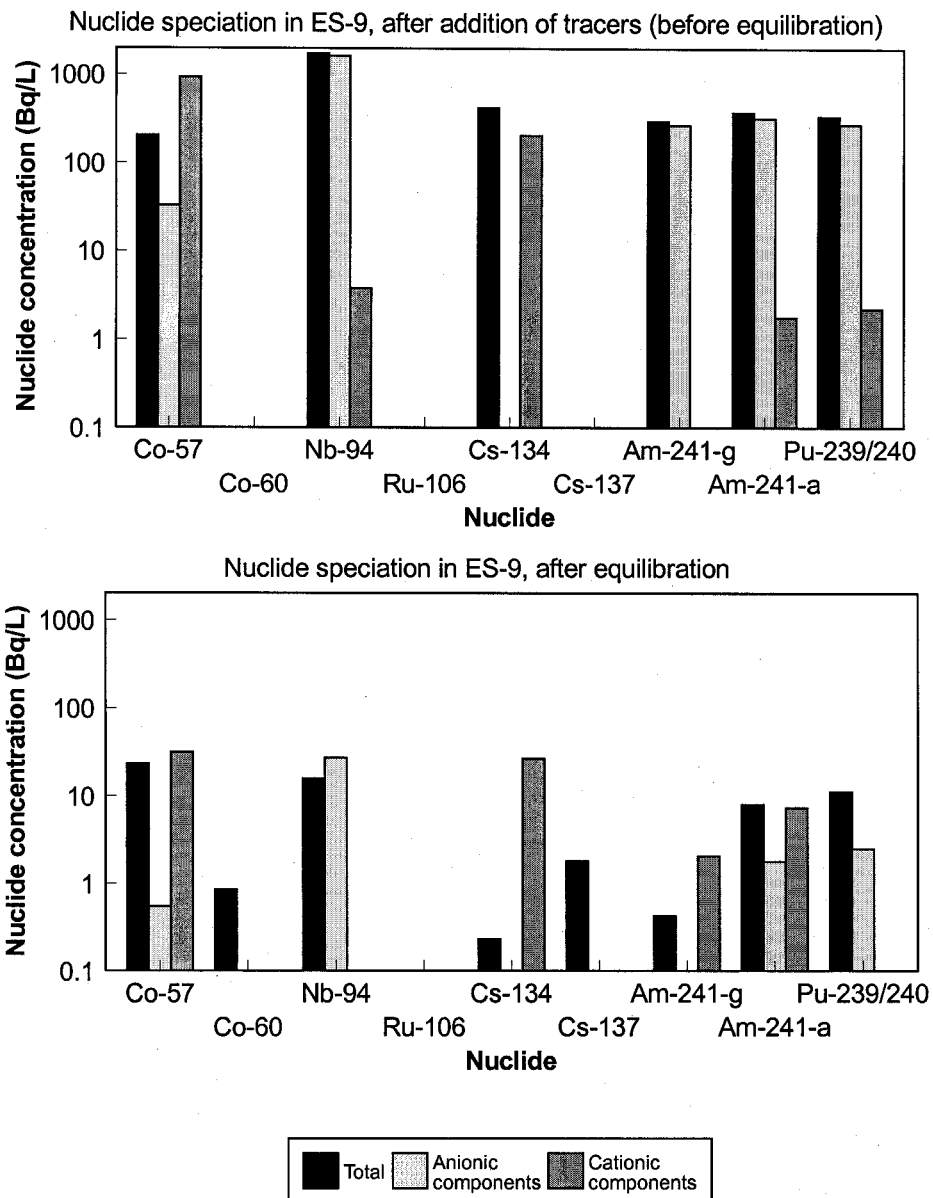
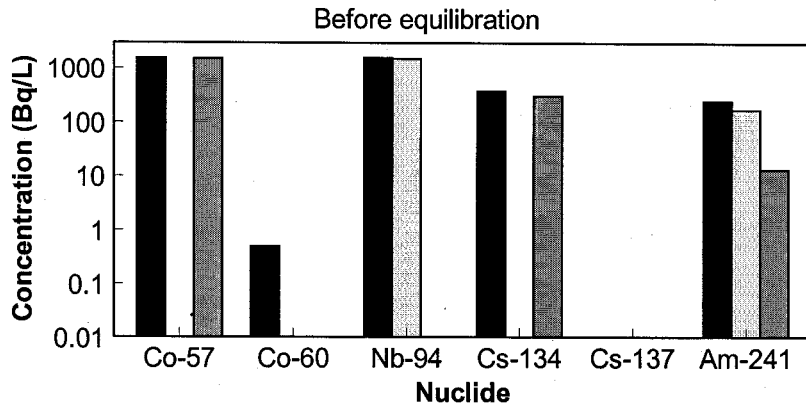

Figure 3.25 Nuclide speciation (tracers only) in the samples for the conventional "batch" K_d determinations before and after equilibration with CRL sand. Note: "Am-241-g" refers to the results obtained with gamma spectrometry, and "Am-241-a" were obtained with alpha spectrometry.

Conventional "batch" K_d determination:
nanofiltered groundwater

Nuclide speciation in ES-9 (all spikes)



Nuclide speciation in ES-9 (all spikes)

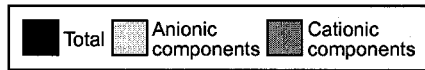
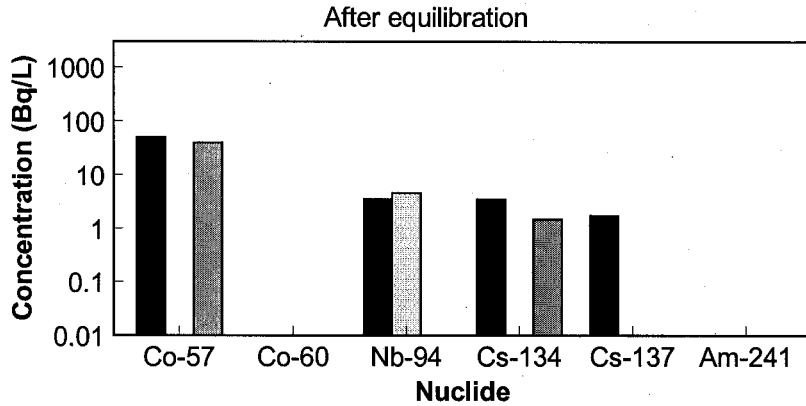

Figure 3.26 Nuclide speciation (tracers only) in the samples for conventional "batch" K_d determinations before and after equilibration with CRL sand (after nanofiltration of the uncontaminated groundwater to remove organics and colloidal particles). Note: "Am-241 results were obtained by gamma spectrometry.

Nuclide speciation stability during the experiment:
contaminated groundwater from ES-16 with added tracers

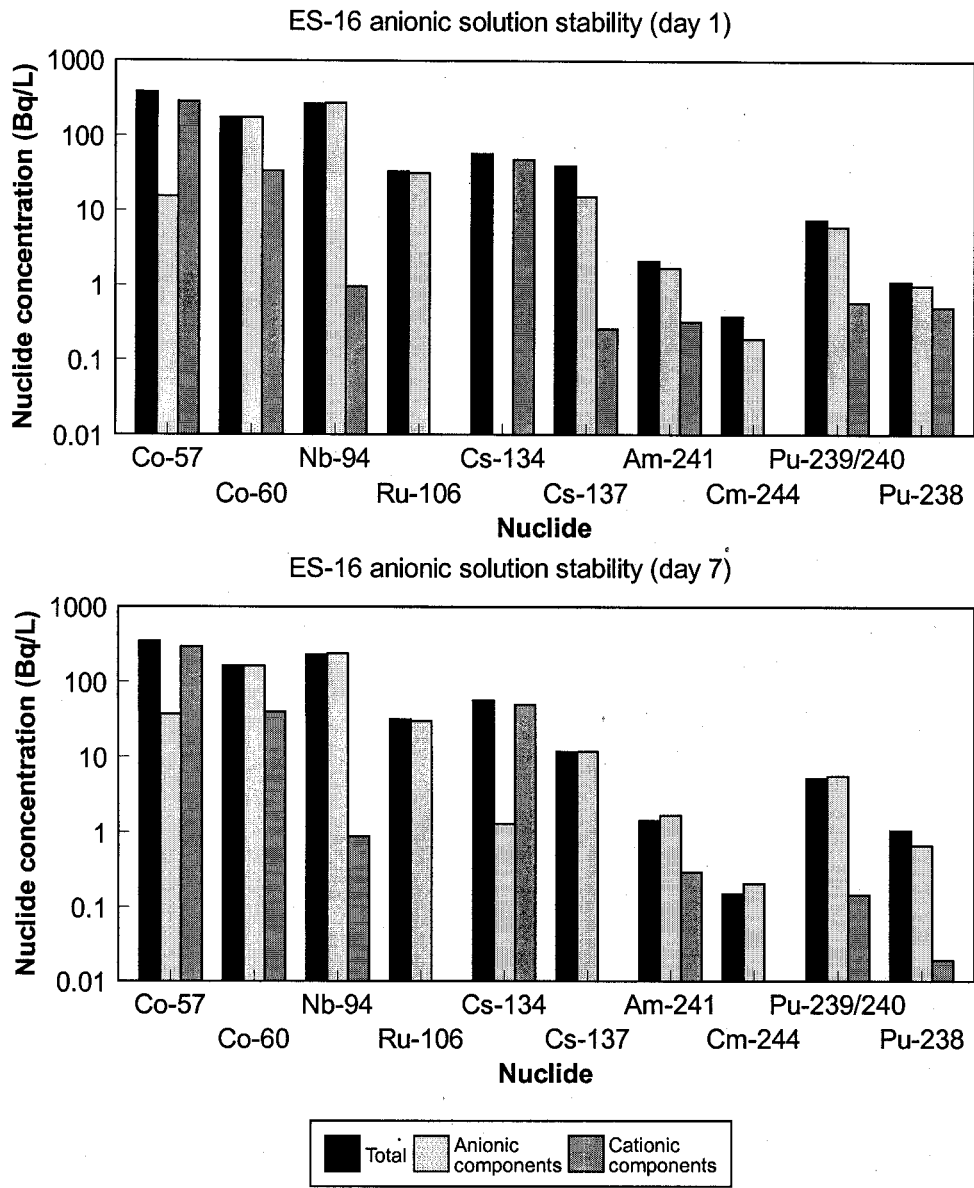

Figure 3.27 Nuclide speciation stability in aqueous solutions during the experiment (ES16 with tracers).

Nuclide speciation stability during the experiment:
 uncontaminated groundwater from ES-9

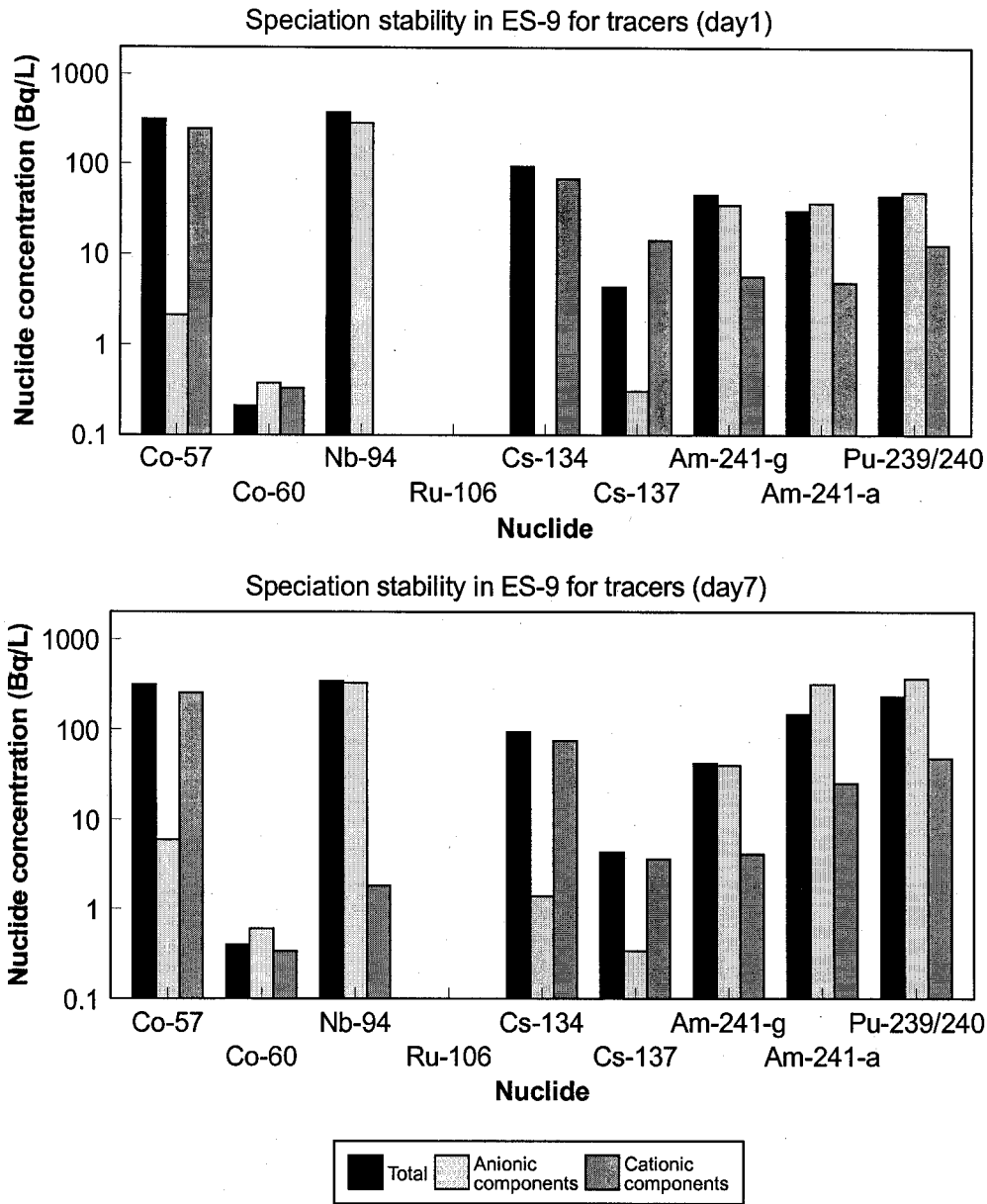

Figure 3.28 Nuclide speciation stability on aqueous solutions during the experiment (ES16 uncontaminated groundwater, with tracers).

4 Summary and Conclusions

The results of this work show changes in colloid and chemical speciation of radionuclides as they migrate down the groundwater flow path from the Chemical Pit to the nearby wetland. Dissolved species dominate throughout the system. This is likely due to complexation of the radionuclides in this system, since there is much evidence for natural complexation (Killey et al., 1984, Cooper and McHugh, 1983). While some radionuclides, such as ^{60}Co and ^{244}Cm showed declining concentrations in the dissolved phase as the plume moves away from the pit, others, such as ^{106}Ru and Pu showed increased concentrations in the wetland.

The anion exchange chromatograms produced from the soluble (<10,000 NMWL) fractions from each well show changes in speciation down the flowline. Cobalt-60 showed the most complex speciation with at least 7 species present. This may be partly due to the fact that the elution scheme had been optimized for ^{60}Co (Cooper et al., 1993). The peaks showed variations in intensity in the samples from the three wells, indicating that chemical forms were evolving in the aquifer.

There was an interesting trend in speciation of the actinide elements. The lower elements in the actinide series were strongly retained by the anion exchange resin and were mostly removed by elution with HCl, probably through destabilization of the complexes. The higher actinides, which were less strongly retained by the resin, were eluted earlier by the KCl. Fewer of their complexes remained on the columns long enough to be eluted in HCl. This trend probably indicated that the lower actinides were in higher oxidation states (i.e. V and VI) and consequently were less highly positively charged (i.e. MO_2^+ and MO_2^{++}) than Am and Cm, which would have a triple positive charge. When complexed with negatively charged ligands, the species of the lower actinides would have a higher net negative charge than similar species of the higher actinides. Species with a higher net negative charge would be more strongly

retained by the anion exchange resin than those with a lower net negative charge.

Anion chromatography measurements made in 1993 and 1996 showed that the concentration of dissolved ^{60}Co in the plume had declined substantially since use of the pits had been discontinued in 1996. The speciation of anionic forms of ^{60}Co has also changed. Some species declined with time and other species appeared in the plume groundwater.

The UV chromatograms showed that organic species were also concentrated and chromatographically separated on the anion exchange columns. Peaks occurred in similar regions as peaks in the ^{60}Co chromatogram. The peaks that eluted in KCl were due to species which exhibited a broad absorbance across the UV spectrum. Species that eluted in HCl showed broad peaks at 240 nm and 340 nm. The organics in uncontaminated groundwater gave generally similar chromatograms and UV spectra. This showed that most of the organic species were of natural origin.

The anion exchange chromatograms from the May 15 sample showed that the chromatographic separations were quite consistent and that the technique could be used to measure small changes in speciation with time. The technique also showed that anionic forms of ^{137}Cs were present in the groundwater plume.

A novel approach for determining the sorption coefficient K_d of nuclides with geological material was used in this study. The approach consisted of passing separate aliquots of contaminated groundwater through a cation exchange resin (to remove cationic species of radionuclides) and an anion exchange resin (to remove anionic species of nuclides). Each isolated solution was then contacted with uncontaminated sand to separately determine K_d values of the anionic species and cationic species of nuclides. The values were compared with K_d s measured, after spike additions of different isotopes of

the same set of elements, to determine the importance that aqueous speciation has on sorption. These values were also compared to a conventional "batch" K_d determination with singly tracers added.

The results showed that K_d 's for spike additions of Co, Pu and Am were at least one order of magnitude higher than the values for the same nuclides present in the contaminant plume. In the case of Cs, the difference was two orders of magnitude or more. This demonstrated that using tracer solutions to determine K_d values in the laboratory could overestimate sorption compared to the field conditions.

The nuclide speciation, defined as the relative abundance of dissolved negative species

versus positive species, was stable during the experiment. The ^{57}Co speciation, after equilibration, was similar to the original speciation, but different from that of ^{60}Co at any point, which suggested that the species responsible of complexing ^{60}Co were stable and non-exchangeable.

Performance assessment modelers would be able to use the "field" K_d values developed in this study for modeling radionuclide transport at similar LLW disposal sites. More accurate predictions of the "first-arrival" times of the mobile complexed organo-radionuclide species could then be made.

5 References

- ASTM. 1984. *Distribution Ratios by the Short-Term Batch Method*, American Society for Testing and Materials, Philadelphia, PA, Method D 4319-83.
- Baes, C.F., and R.E. Maesmer. 1976. *The Hydrolysis of Cations*. New York, NY: Wiley-Interscience.
- Baston, G.M.M., J.A. Berry, A.K. Littleboy, and N.J. Pilkington. 1992. "Sorption of Activation Products on London Clay and Dungeness Aquifer Gravel". *Radiochim. Acta* **58/59**: 225-233.
- Boggs, S., D. Livermore, and M.G. Seitz. 1985. *Humic Substances in Natural Waters and Their Complexation with Trace Metals and Radionuclides: A Review*. ANL-84-78, Argonne, Illinois.
- Bondietti, E.A. 1982. "Mobile Species of Pu, Am, Cm, Np, and Tc in the Environment." In: *Environmental Migration of Long-Lived Radionuclides*, IAEA-SM-257/42, International Atomic Energy Agency, Vienna, Austria.
- Buddemeier, R. W. and J. R. Hunt. 1988. "Transport of Colloidal Contaminants in Groundwater; Radionuclide Migration at the Nevada Test Site". *Applied Geochem.* **3**: 535-548.
- Cabaniss, S.E., and M.S. Shuman. 1988. "Fluorescence Quenching Measurements of Copper- Fulvic Acid Binding." *Anal. Chem.* **60**:2418-2412.
- Caron, F., C.A. Delmastro, and M.K. Haas. 1997. *Determination of Sorption Coefficients (K_d) for ⁶⁰Co and ⁹⁴Nb in Chalk River Sand, Sand/Dochart Clay and Sand/Clinoptilolite Mixtures*. Unpublished data, file number 0501-0620 Niobium, Atomic Energy of Canada, Ltd., Chalk River Laboratories, Chalk river, Ontario, Canada.
- Caron, F. 1995. *Partition Coefficients for Backfill and Geosphere in the Performance Assessment Calculations of IRUS*, AECL Report, TR-660, Atomic Energy of Canada, Ltd., Chalk River Laboratories, Chalk River, Ontario, Canada.
- Champ, D.R., and D.E. Robertson. 1986. "Chemical Speciation of Radionuclides in Contaminant Plumes at the Chalk River Nuclear Laboratories. In: *Speciation of Fission and Activation Products in the Environment*. Bulman, R.A., and J.R. Cooper (Eds.). Elsevier Appl. Sci., London, UK.
- Champ, D.R., J.L. Young, D.E. Robertson, and K.H. Abel. 1985. "Chemical Speciation of Long-Lived Radionuclides in a Shallow Groundwater Flow System." *Water Poll. Res. J. Canada* **19**, 2.
- Choppin, G.R. 1988. "Humics and Radionuclide Migration." *Radiochim. Acta* **44/45**:23-28.
- Cooper, E.L., and J.F. Mattie. 1993. *Report on Speciation Studies of Radionuclides in the Chemical Pit Plume*, AECL Report; RC-978, Atomic Energy of Canada, Ltd., Chalk River Laboratories, Chalk River, Ontario, Canada.
- Cooper, E.L. and J.O. McHugh. 1983. "Migration of Radiocontaminants in a Forested Wetland on the Canadian Shield: Nuclide Speciation and Arboreal Uptake". *Science Tot. Environ.*, **28**, 215-230.
- Cooper, E.L., P. Vilks, M.K. Haas and J.F. Mattie. 1993. *Study of Radionuclide Speciation in Groundwater Using Anion Exchange Resins*. AECL Report, RC-1150, Atomic Energy of Canada, Ltd., Chalk River Laboratories, Chalk River, Ontario, Canada.
- Cooper, E.L., M.K. Haas and J.F. Mattie. 1995. "Studies of the Speciation of Plutonium and Other Actinides in Natural Groundwater Using Anion Exchange Resin". *Appl. Radiat. Isot.*, **46**, 1159-1173.

- Cooper, E.L. 1999. Personal Communication, Chalk River Laboratories, Chalk River, Ontario, Canada.
- Cotton, F. A., and G. Wilkinson. 1980. *Advanced Inorganic Chemistry (4th Edition)*. New York, NY: J. Wiley and Sons.
- Ewald, M., C. Belin, and P. Berger. 1983. "Corrected Fluorescence Spectra of Fulvic Acids Isolated from Soil and Water." *Environ. Sci. Technol.* 17:501-504.
- Florence, T.M. 1982. "The Speciation of Trace Elements in Waters." *Talanta* 29:345-364.
- Jackson, R.E., and K.J. Inch. 1983. "Partitioning of Strontium-90 Among Aqueous and Mineral Species in a Contaminated Aquifer". *Environ. Sci. Technol.* 17: 231-237.
- Jensen, B.S., and H. Jensen. 1988. "Complex Formation of Radionuclides with Organic Ligands Commonly Found in Groundwater." *Radiochim. Acta* 44/45:45-49.
- Kersting, A. B., D. W. Efurud, D. L. Finnegan, D. J. Rokop, D. K. Smith, and J. L. Thompson. 1999. "Migration of Plutonium in Ground Water at the Nevada Test Site", *Nature* 397, Jan. 7: 56-59.
- Killey, R.W.D., J.O. McHugh, D.R. Champ, E.L. Cooper and J.L. Young. 1984. "Subsurface Cobalt-60 Migration from a Low-Level Waste Disposal Site". *Environ. Sci. Technol.*, 18(3), 148-157.
- Killey, R.W.D., and J.H. Munch. 1984. *Subsurface Contaminant Transport from the Liquid Disposal Area, CRNL: (1) Hydrogeology and Tritium Contamination near the Chemical Pit*. AECL-7691, Atomic Energy of Canada, Ltd., Chalk River Laboratories, Chalk river, Ontario, Canada.
- Killey, R.W.D., and J.F. Mattie. 1993. *Carbon-14 in the Vicinity of Waste Management Area C: Results of a Scoping Study*. AECL-10795, Atomic Energy of Canada, Ltd., Chalk River Laboratories, Chalk River, Ontario, Canada.
- Killey, R.W.D., and J.H. Munch. 1993. *Performance of the Impermeable Cover at Area C - Status to 1992*. TR-506, Atomic Energy of Canada, Ltd., Chalk River Laboratories, Chalk River, Ontario, Canada.
- Killey, R.W.D., R.R. Rao, and S. Eyvindson. 1993. *Radiocarbon Speciation and Distribution in an Aquifer Plume and Groundwater Discharge Area, Chalk River, Ontario*. RC-1135, Atomic Energy of Canada, Ltd., Chalk river Laboratories, Chalk River, Ontario, Canada.
- Levesque, M. 1972. "Fluorescence and Gel Filtration of Humic Compounds." *Soil Sci.* 113(5):346-353.
- Lieser, K.H., B. Gleitsmann, S. Peschke, and T.H Steinkopff. 1986. "Colloid Formation and Sorption of Radionuclides in Natural Systems." *Radiochim. Acta* 40:39-47.
- Lieser, K.H., A. Ament, R. Hill, R.N. Singh, U. Stingl, and B. Thybusch. 1991. "Colloids in Groundwater and Their Influence on Migration of Trace Elements and Radionuclides." *Radiochim. Acta* 49:83-100.
- McCarthy, J.F. 1988. *Role of Colloidal Particles in the Subsurface Transport of Contaminants*. DOE/ER-0384, U.S. Department of Energy, Washington, D.C.
- McCarthy, J.F., and J.M. Zachara. 1989. "Subsurface Transport of Contaminants." *Environ. Sci. Technol.* 23:496-502.
- Olsen C.R., P.D. Lowry, S.Y Lee, I.L. Larsen, and N.H. Cutshall. 1986. "Geochemical and Environmental Processes Affecting Radionuclide Migration from a Formerly Used Seepage Trench." *Geochim. Cosmochim. Acta* 44/45:165-170.
- Patterson, R.J., and T. Spoel. 1981. "Laboratory Measurements of the Strontium Distribution Coefficient for Sediment from a Shallow Sand Aquifer." *Water Resources Res.* 17(3):513-520.

- Penrose, W.R., W.L. Polzer, E.H. Essington, D.M. Nelson, and K.A. Orlandini. 1990. "Mobility of Plutonium and Americium Through a Shallow Aquifer in a Semi-arid Region". *Environ. Sci. Technol.* 24: 228-234.
- Petit, J.C. 1990. "Migration of Radionuclides in the Geosphere: What Can We Learn from Natural Analogues?", *Radiochim. Acta* 51:181-188.
- Pickens, J.F., R.E. Jackson, and K.J. Inch. 1981. "Measurement of Distribution Coefficients using a Radial Injection Dual-Tracer Test." *Water Resources. Res.* 17(3):529-544.
- Rai, D., and R.J. Serne. 1978. *Solid Phases and Solution Species of Different Elements in Geologic Environments*. PNL-2651, Pacific Northwest Laboratory, Richland, Washington.
- Ramsay, J.D.F. 1988. "The Role of Colloids in the Release of Radionuclides from Nuclear Waste." *Radiochim. Acta* 44/45:165-170.
- Rao, R.R., and E.L. Cooper. 1995. "Separation of Low Levels of Actinides by Selective Oxidation/Reduction and Co-Precipitation with Neodymium Fluoride". *J. Radioanal. Nucl. Chem. (Art.)* 197: 133-148.
- Riley, R.G., and J.M. Zachara. 1992. *Chemical Contaminants on DOE Lands and Selection of Contaminant Mixtures for Subsurface Science Research*. DOE/ER-0547T, U.S. Department of Energy, Washington, D.C.
- Robertson, D. E. 1986. "Evaluation of a Large Volume Water Sampling Technique for Determining the Chemical Speciation of Radionuclides in Groundwater". In: *Speciation of Fission and Activation Products in the Environment*. Bulman, R.A., and J.R. Cooper (Eds.). Elsevier Appl. Sci., London, UK.
- Robertson, D.E., M.P. Bergeron, D. Holford, K.H. Abel, C.W. Thomas, D.A. Myers, D.R. Champ, R.W.D. Killey, D.L. Moltyaner, J.L. Young, and T. Ohnuki. 1989. *Demonstration of Performance Modeling of a Low-Level Waste Shallow-Land Burial Site*. NUREG/CR-4879 vol. 2, U.S. Nuclear Regulatory Commission, Washington, D.C.
- Robertson, D.E., and R.W. Perkins. 1975. "Radioisotope Ratios in Characterizing the Movement of Different Physical and Chemical Species through Natural Soils." In: *Isotope Ratios as Pollutant Source and Behavior Indicators*, International Atomic Energy Agency, Vienna, Austria.
- Robertson, D.E., M.P. Bergeron, D. Holford, K.H. Abel, C.W. Thomas, D.A. Myers, D.R. Champ, R.W.D. Killey, D.L. Moltyaner, J.L. Young, and T. Ohnuki. 1989. *Demonstration of Performance Modeling of a Low-Level Waste Shallow-Land Burial Site*. NUREG/CR-4879 vol. 2, U.S. Nuclear Regulatory Commission, Washington, D.C.
- Robertson, D. E., A. J. Schilk, K. H. Abel, E. A. Lepel, C. W. Thomas, S. L. Pratt, E. L. Cooper, P. Hartwig, R. W. D. Killey. 1995. "Chemical Speciation of Radionuclides Migrating in Groundwaters". *J. Radioanal. Nuc. Chem.* 194:237-252.
- Schilk, A. J., D. E. Robertson, K. H. Abel, E. L. Cooper, R. W. D. Killey, P. G. Hartwig, C. W. Thomas, S. L. Pratt, P. Vilks, J. F. Mattie, M. K. Haas, E. A. Lepel, R. Matzner, and K. King. 1996. *The Role of Organic Complexants and Microparticulates in the Facilitated Transport of Radionuclides*. NUREG/CR-6429, U. S. Nuclear Regulatory Commission, Washington, D. C. 20555-0001.
- Sheppard, M.I., and D.H. Thibault. 1990. "Default Soil Solid/Liquid Partition Coefficients, Kds, for Four Major Soil Types: a Compendium". *Health Phys.* 59: 471-482.
- Summers, R.S., P.K. Cornel, and P.V. Roberts. 1987. "Molecular Size Distribution and Spectroscopic Characterization of Humic Substances." *Sci. Total Environ.* 62:27-37.
- Ticknor, K.V., L. Boisvenue, and T.T. Vandergraaf. 1996. *The Sorption of Radioelements on Sand from the Chalk River Site*, AECL Report, TR-755, Atomic Energy of Canada, Ltd., Chalk river Laboratories, Chalk River, Ontario, Canada.

Warwick, P., A. Hall, P. Shaw, J.J.W. Higgs, G.M. Williams, B. Smith, D. Haigh, and D. Noy. 1991. "The Influence of Organics in Field Migration Experiments (Part 2)." *Radiochim. Acta* 52/53:465-471.

Welch, S.J. and R.W.D. Killey. 1997. *Soil Coring and Bitumen Block Sampling in Infiltration Lysimeter 5*. AECL Report, TR-689 (in prep), Atomic Energy of Canada, Ltd., Chalk River Laboratories, Chalk River, Ontario, Canada.

Williams, G.M., J.J.W. Higgs, M.A. Sen, W.E. Falck, D.J. Noy, G.P. Wealthall, and P. Warwick. 1991. "The Influence of Organics in Field Migration Experiments (Part 1)." *Radiochim. Acta* 52/53:457-463.

Wobber, F.J. 1991. *Subsurface Science Program: Program Overview and Research Abstracts*. DOE/ER-0432, U.S. Department of Energy, Washington, D.C.

Link, S. O., K. J. King, M. Benz, W. G. Evenden, D. E. Robertson. 1999. *Environmental Dynamics of Carbon-14 Near a Low-Level Radioactive Waste Burial Ground*. NUREG/CR-6587, U. S. Nuclear Regulatory Commission, Washington, D. C.

Appendices

Appendix 1

Instructions for Preparation of Chromatographic Columns Version 2, 96-02

Materials:

3/8" O.D. polyethylene tubing
3/8" tubing to 1/4"-28 th chromatography end fittings
Slurry reservoir
porous polyethylene frits- 3/8" diameter (cut from larger discs with leather punches)
AG MP-1 resin 200-400 mesh
double distilled water(purge with He for 5 minutes)
Omnifit 2-way valve
lengths of Teflon tubing with 1/4"-28 th fittings

Equipment:

Alcott model 760 HPLC pump
400 to 600 mL beakers.
disposable plastic pipettes

Method:

- 1) Cut a length of polyethylene tubing: 7 mm for guard columns, 25 mm for separation columns. The longer columns can be straightened if they are first heated in an oven(don't melt them).
- 2) Fit an end fitting on one end of the column. Replace the frit if need be.
- 3) Fit an end fitting to the other end of the column. Replace the frit if need be.
- 4) Remove the top fitting, but leave the nut on the tubing. Attach the slurry reservoir to the top of the column.
- 5) Attach a 2-way Omnifit valve to the bottom of the column. Fit a length of Teflon tubing into the valve and insert the other end into a beaker. Clamp the assembly vertically to a stand with the valve at the bottom.
- 6) Weigh out approximately 10 g of AG MP-1 resin into a plastic bottle and slurry it with about 50 mL of distilled water. If fines are floating on the top of the water, then decant them off. Using a plastic pipette, transfer portions of resin slurry to the column (note: experience has been that the slurry will have to be slightly pressurized initially with a syringe to wet the frits and establish gravity flow. Alternatively, wet the frits by forcing water through them prior to assembling onto the columns.). Allow the water to drain between additions, but do not allow the liquid level to fall below the top of the bed. Continue adding resin until the resin bed is slightly above the top of the polyethylene tube.
- 7) Fill the slurry reservoir with distilled water and allow to drain almost to the resin bed under gravity flow. If the resin bed is still above the top of the column then shut off the Omnifit valve. If the resin bed has compacted to below the top of the column, then add more slurry and repeat the packing with distilled water under gravity flow.

8) Remove the slurry reservoir and replace it with the end fitting. During assembly of these fittings distilled water will have to be added to displace air. Connect the adapter to the pump with Teflon tubing (purge the air out of the tubing before connecting).

10) Open the Omnifit valve and pump several hundred mL of distilled water through the column at a flow rate of 10 mL/minute.

11) Stop the pump and close the Omnifit valve. Remove the end fitting from the top of the column. If the bed has packed down below the top of the column, then refit the slurry reservoir and carefully add more resin slurry to top it up. Drain away excess water through the Omnifit valve. Continue adding slurry until the bed is at or above the top of the tubing.

12) Fill the upper end fitting with water and fit it onto the column. This is the inlet end of the column. If the column is to be stored, then fill the inlet with water and fit a plug part way into the end fitting. If the valve is removed from the outlet, then it will have to be similarly plugged.

Appendix 2

Procedure for Chromatographic Separation, 96-05

Instructions for Chromatographic Separation, 96-05

1) Set up the apparatus as shown in the figure, but leave out the NaI flow cell and use 0.5 M KCl for the gradient. Use the gradient programmer instead of the system shown in the figure. Set up the UV detector between the columns and the fraction collector.

2) De-gas 4 L of ES16 water by purging with helium for 5 minutes. There is a tank of helium in Jim Young's lab by the hall tree.

3) Connect the tube to the groundwater reservoir to position 1 of the Scanivalve.

4) Load columns overnight at 3 mL/min.

5) Rinse the columns with 20 mL (6.5 min.) of distilled water.

6) Begin collecting fractions and start recording the signal from the UV detector. Rinse the columns with 30 mL (10 min.) of pH 4.5 HCl.

7) Elute the columns with a KCl gradient: 85 min. to 50% 0.5 M KCl.

8) Elute the columns with a KCl gradient: 40 min. to 100% 0.5 M KCl.

9) Elute the columns for 60 min. with 100% 0.5 M KCl.

9a) Elute the columns with a 0-100% 0.1 M HCl gradient for 20 minutes.

10) Elute the columns for 50 min. with 100% 0.1 M HCl.

11) Rinse the columns with double distilled water for 90 min. and shut down the system. The rinse can be collected in a bottle and discarded.

12) Remove the samples from the racks, cap and number them, and store in the coldroom.

13) Count the samples on the Packard auto gamma counter and return to storage in the coldroom. Try to minimize the amount of time that the samples are out of the coldroom.

Elution Scheme

<u>Eluent</u>	<u>Volume(mL)</u>	<u>Time(min)</u>
distilled water	20	6.5
pH 4.5 HCl	30	10
gradient to 0.25 M KCl	255	85
gradient to 0.5 M KCl	120	40
0.5 M KCl	180	60
gradient to 0.1 M HCl	60	20
0.1 M HCl	270	90
distilled water	150	50

Scanivalve Ports

<u>Position</u>	<u>Connection</u>
1	groundwater reservoir
2	distilled water
3	pH 4.5 HCl
4	gradient programmer
5	0.5 M KCl
6	0.1 M HCl
7	distilled water

ins9605a.doc

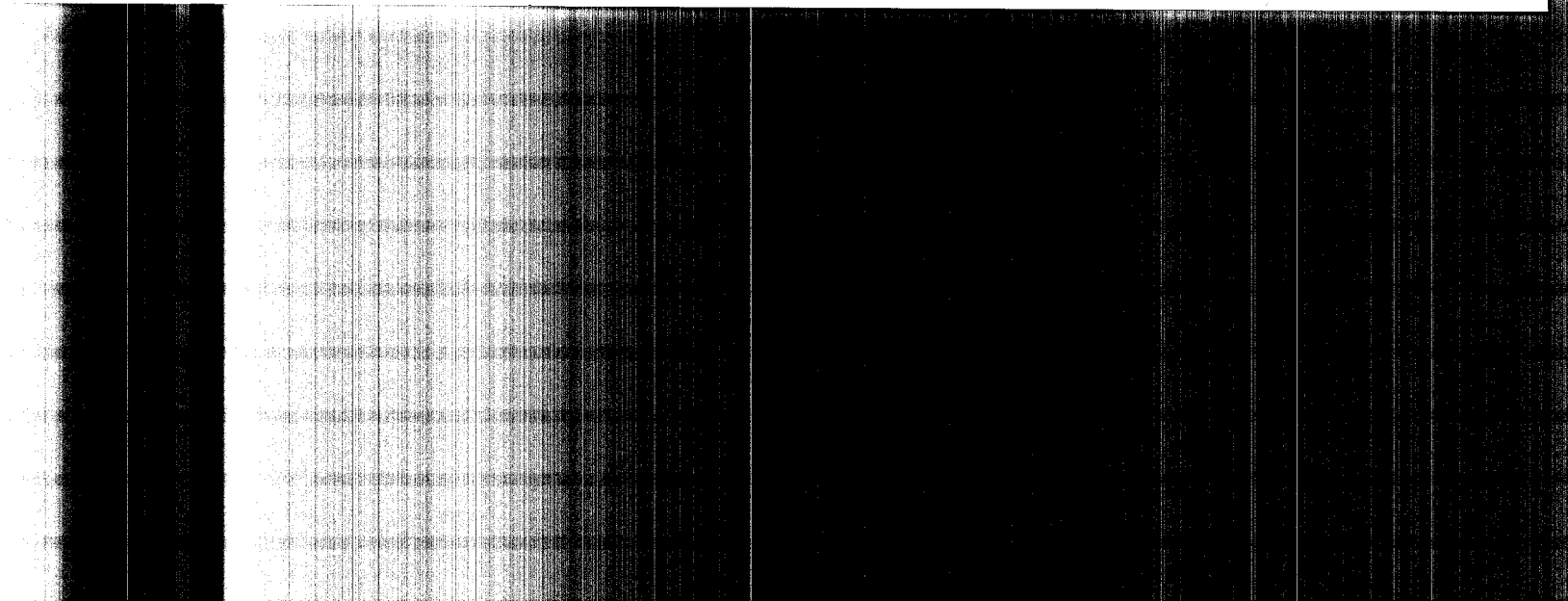
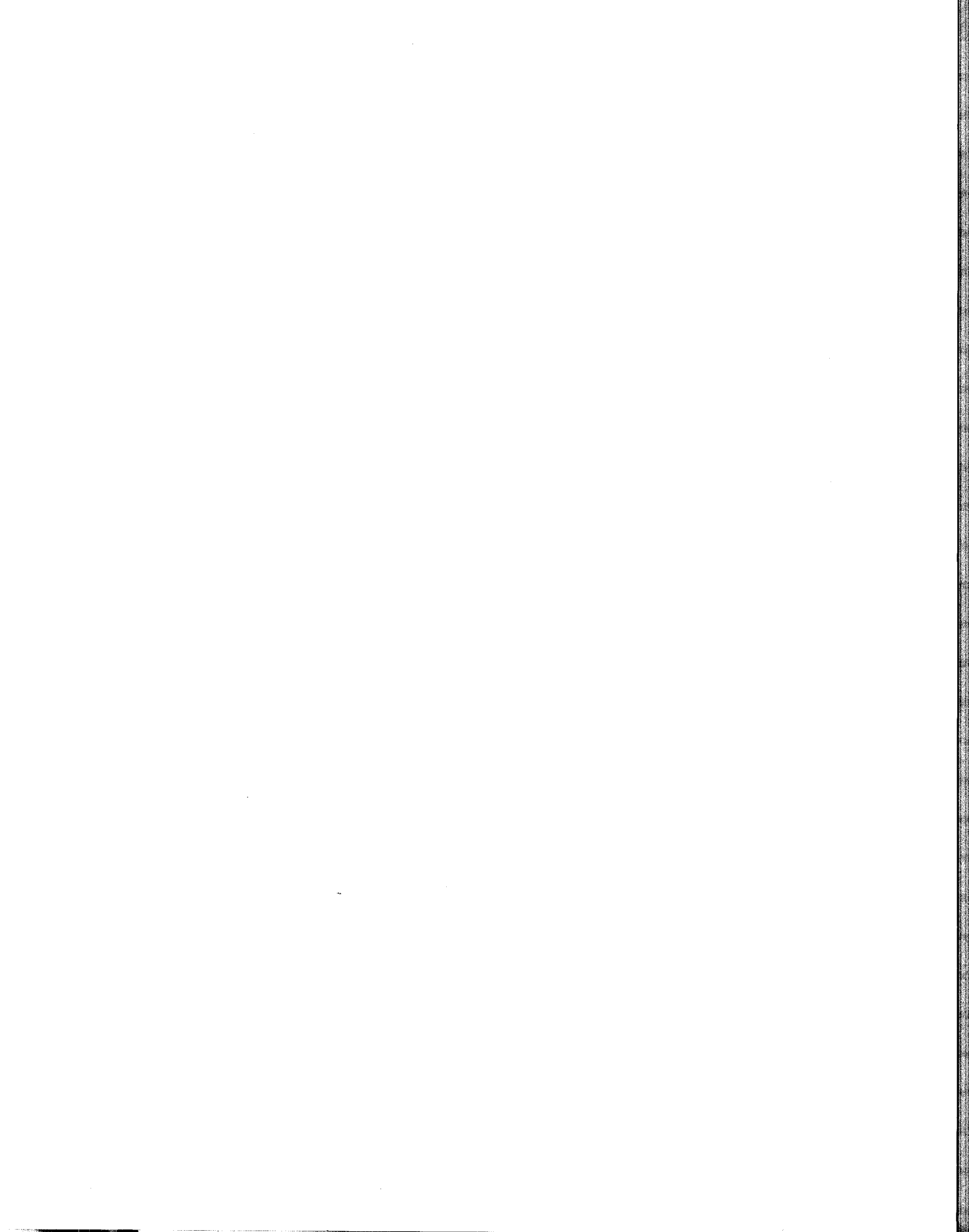

BIBLIOGRAPHIC DATA SHEET

(See instructions on the reverse)

NUREG/CR-6627

2. TITLE AND SUBTITLE

The Role of Organic Complexants and Colloids in the Transport of Radionuclides
by Groundwater - Final Report

3. DATE REPORT PUBLISHED

MONTH YEAR

January 2000

4. FIN OR GRANT NUMBER

L1935

5. AUTHOR(S)

D. E. Robertson, C. W. Thomas, S. L. Pratt, K. H. Abel, E. A. Lepel, A. J. Schi lk (a)
E. L. Cooper, F. Caron, K. J. King, R. W. D. Killey, P. G. Hartwig, J. F. Mattie, M. K. Haas, (b)
S. O. Link (c)
P. Vilks (d)

6. TYPE OF REPORT

Technical

7. PERIOD COVERED (Inclusive Dates)

8. PERFORMING ORGANIZATION - NAME AND ADDRESS (If NRC, provide Division, Office or Region, U.S. Nuclear Regulatory Commission, and mailing address; if contractor, provide name and mailing address.)

(a) Pacific Northwest National Laboratory, Box 999, Richland, WA 99352, (b) Chalk River Laboratories, Chalk River, Ontario KOJ1JO,
Canada, (c) Washington State University at Tri-Cities, Richland, WA 99352, (d) Whiteshell Laboratories, Whiteshell, Manitoba ROE1LO,
Canada

9. SPONSORING ORGANIZATION - NAME AND ADDRESS (If NRC, type "Same as above"; if contractor, provide NRC Division, Office or Region, U.S. Nuclear Regulatory Commission, and mailing address.)

Division of Risk Analysis and Applications
Office of Nuclear Regulatory Research
U.S. Nuclear Regulatory Commission
Washington, DC 20555-0001

10. SUPPLEMENTARY NOTES

E. O'Donnell, NRC Project Manager

11. ABSTRACT (200 words or less)

This final report describes the results of field and laboratory work conducted during the last two years of the project. These studies will provide performance assessment modelers and regulators with additional information to better assess the rates and mechanisms of radionuclide transport from LLW disposal facilities that become infiltrated with water. The field studies were conducted at two low-level radioactive waste (LLW) management areas within the boundaries of the Chalk River Laboratories, Chalk River, Ontario, Canada, under a cooperative arrangement with the Atomic Energy of Canada, Ltd. At these locations, several well-defined, slightly radioactive groundwater contaminant plumes have developed over the past 25 to 40 years, providing excellent field sites for conducting studies of radionuclide transport by groundwater. These studies have primarily addressed: 1) characterization of the sub-surface geochemical environment near the disposal facilities, 2) identification and quantification of the migrating radionuclides and their chemical speciation in groundwater, 3) the sorption behavior (Kd measurements) of the mobile radionuclide species (cationic and anionic) onto site soils, 4) identification of colloidal radionuclides, and 5) the environmental dynamics of ¹⁴C in the vicinity of a solid LLW disposal facility (published earlier as NUREG/CR-6587).

12. KEY WORDS/DESCRIPTORS (List words or phrases that will assist researchers in locating the report.)

radionuclide transport
groundwater
colloids
organic complexation
radionuclide speciation
low-level radioactive waste

13. AVAILABILITY STATEMENT

unlimited

14. SECURITY CLASSIFICATION

(This Page)

unclassified

(This Report)

unclassified

15. NUMBER OF PAGES

16. PRICE