

October 27, 2005

U. S. Nuclear Regulatory Commission
Washington, DC 20555-0001

ATTENTION: Document Control Desk

Subject: Topical Report of Delta Protection Mururoa BLU Single Use Suits

Delta Protection, a member of the Bacou Dalloz group of companies, is submitting a topical report with identifier MURUBLU05NP entitled "Topical Report for Delta Protection Mururoa BLU Suit Systems" on Thursday October 27, 2005, under the NRC licensing Topical Report Program, for review and acceptance for referencing in licensing actions. Delta Protection, a member of the Bacou Dalloz group of companies, is requesting the Nuclear Regulatory Commission (NRC), to perform a "Topical Report Review" on our "Mururoa BLU Single Use" encapsulating suit systems. Technically, the review is based on two (2) suits. The "Mururoa BLU PVC", and the "Mururoa BLU Ethyfuge", both will use identical powered air devices and filters. The only difference between the suits is that the outside fabric is of different composition. The NRC, in supplied air suit systems manufactured by Delta Protection, has previously approved both suit fabrics for use. The intent of the review is to gain "Generic Approval" for use of the suit systems at various NRC nuclear facilities, such as operating reactor sites where the "Topical Report" will be referenced in various applications. This involves establishing an assigned protection factor of 2000, as well as establishing two (2) operating air-flow parameters of 400 litres/minute and 600 litres/minute involving the use of both the Scott PF10 P3, and the Delta Protection P3 filters. These sites are under NRC jurisdiction and can be, but are not limited to nuclear power plants (operating reactors), research and test reactors, gaseous diffusion plants, as well as reactor sites and nuclear facilities that may be subjected to decommissioning, such as Humboldt Bay.

The Topical Report Review and Approval Process will increase the efficiency of the licensing process and reduce the burden on the licensees by minimizing the time and resources that industry and the NRC could expend on repetitive reviews of the same topic.

The content of the submittal involves discussions related to the applicability of the suits, as well as the discussions on the conditions of use of the suits. In addition, Delta Protections Quality assurance policies will be discussed. The technical justification requirement will contain detailed descriptions of the suit systems, which consist of the suits themselves, as well as the powered air devices (blowing units), filters. In addition, all supportive documentation related to the suit systems certification to the EN standards will be revealed. The Mururoa BLU suit systems are basically a ventilated protective suit against radioactive contamination and has been evaluated according to the EN1073-1:1998 standard. For an efficient precise review and approval the notified



TOLD

body also performed tests on the blowing unit and filters based on the EN 12941:1998 (powered air respiratory devices). All instructions for use, as well as technical proof of performance will be included. In addition, Delta Protection has included a side-by-side comparison regarding the proposed (PAPR) industry standard to our suit systems. Of course, suit system performance varies greatly to regular powered air purifying devices. However, we thought that this would be extremely useful when pointing out critical performance aspects of the suit systems.

For the sake of clarity, this topical report submittal contains non-proprietary information, and should be treated as such. This topical report will be needed to be approved by Jan 31, 2006. Please send all correspondence to our office in Montreal, Quebec, Canada, at 4200 St. Laurent Blvd. Montreal, Quebec, Canada, H2W-2R2.

We trust the following report meets with the expectations of the Nuclear Regulatory Commission (NRC). We look forward to establishing an acceptable schedule, establishing costs, and moving forward in order to gain an acceptance letter.

Sincerely,



Gary Zimmermann
Business Development Manager
Delta Protection/Bacou Dalloz

**TOPICAL REPORT SUBMITTAL OF DELTA PROTECTION MURUROA BLU SINGLE
USE ENCAPSULATING SUITS”**

1.0 COVER LETTER.....1

2.0 TOPICAL REPORT ACCEPTANCE CRITERIA DISCUSSION.....4

3.0 MURUROA SUIT SYSTEM APPLICABILITY4

4.0 DELTA PROTECTION QUALITY ASSURANCE.....6

5.0 REGULATORY REQUIREMENTS.....6

 5.1 Requirements of 10 CFR20 and Appendix A.....6

6.0 TECHNICAL JUSTIFICATION.....7

 6.1 Scope.....7

 6.2 Suit Construction and Blowing Unit.....8

 6.3 Safety Features of the Mururoa BLU Self Fed Suits.....9

 6.4 Implementation.....10

 6.5 Conclusion.....11

6.6 ATTACHMENTS

 6.6.1 EC Type Examination Certificate 0401119 for the Mururoa BLU PVC.

 6.6.2 EC Type Examination Certificate 0401120 for the Mururoa BLU Ethyfuge

 6.6.3 “Test Report” No. 200323085/2120 for both Mururoa BLU suits.

 6.6.4 Mururoa BLU PVC Instructions for Use

 6.6.5 Mururoa BLU Ethyfuge Instructions for Use

 6.6.6 Instruction Manual for C500 Blowing Unit

 6.6.7 PRO 2000 Filters Description and Technical Data

 6.6.8 EN 1073-1:1998 European Standard

 6.6.9 EN 12941:1998 European Standard for Powered Air Respirators

 6.6.10 Side by Side Comparison of Proposed PAPR standard/Mururoa BLU Suit System.

2.0 TOPICAL REPORT ACCEPTANCE CRITERIA DISCUSSION

As mentioned in the above cover letter, this topical report submittal will result in the increase in efficiency of the licensing process and reduce the burden on licensees by minimizing the time and resources that the industry and the NRC could expend on repetitive reviews of the same topic.

Delta Protection is involved in the research and development, design, manufacturing and marketing of anti-contamination clothing systems to, specifically, the nuclear industry. The use of Delta Protection suits, specifically the Mururoa BLU suits will result in the reduction of integrated dose. Furthermore, personal contamination events (PCE's) are dramatically reduced, resulting in less costly man-hours dedicated to the above-mentioned events. In addition, suit use is specifically related to "occupational Safety" regarding an operating nuclear power plant, or a plant, for instance, that would be performing decommissioning. The Topical Report will be referenced in a number of commercial power plant applications, as well as other sites that are involved in decommissioning activities. At present, operating reactor sites such as Perry, Turkey Point, Calloway, South Texas Project, and Limerick, all have expressed the need to use our products to their advantage. In several applications, plants may use the suits to directly affect critical path. In addition, and because of the unique "Whole Body" protection afforded by the suits, Humboldt Bay" has requested the use of these suits for their decommissioning efforts. We anticipate that the Mururoa BLU suits will be part of their standard protective equipment arsenal in the very near future.

The following report will contain detailed and complete information on the specific subject presented.

In the past, licensees have applied for the use of air fed suits by Delta Protection. This has resulted in the repetitive use of the NRC's resources and time in order to review the technical submittal provided by the licensees. The following report is intended to eliminate that process and to increase the efficiency. We see this as a definitive advantage for all parties involved.

3.0 MURUROA BLU SUIT SYSTEM APPLICABILITY

The Mururoa BLU single use suits, have combined the best of two worlds in one, easy to use encapsulating suit system. This results in licensees to use the suits in high risk radioactive contaminated areas where whole body protection is required. The suits generate uncompromised respiratory protection thus protecting the individual from radioactive particles that can be solid or liquid in nature. In addition, and due to the suits encapsulating nature, personal contamination events are dramatically reduced. In areas where the likelihood of inhaling a hot particle was present, the suits would offer exceptional protection from this due to it's respiratory protection capabilities. The suits full body air distribution network enables the user to perform tasks in a more efficient manner, due to the cooling effect, whereby extending stay times which may affect critical path. In general, any area that possesses a risk for radioactive contamination, or for liquid contamination are areas where the suits can be used. Here are some and definitely not all of the applications that would require the BLU suits in pressurized water reactors (PWR) and boilers (BWR).

1) Access to Fuel Transfer Canal

This area is highly contaminated. Some licensees use PAPR hood style respirators, however, the hood must be secured to prevent sliding. This obscures the workers vision. In addition, plastic suits must be worn in coordination with the hoods. This results in a heat stress issue. The BLU suits will result in better cooling and overall easier use.

2) Reactor Vessel O-ring groove cleaning and inspection

The use of air fed hoods for this work to prevent intakes and personal contamination events was typically used. However, 3-4 workers in the cavity have a tendency to entangle air lines, which the Mururoa BLU suits would eliminate.

3) Reactor Cavity Decontamination

Traditionally, this was performed using full face air purifying respirators and plastic suits. This is heavy work and heat stress is an issue. Critical path is lost when workers must exit when fatigued. As a substitute, some licensees use face shields to minimize heat stress, but this results in facial and nasal contaminations due to chronic low -level airborne radioactivity (<2 DAC). The ideal solution is to use the Mururoa BLU that results in better convective cooling, and eliminates personal contamination events. In addition, all air borne risk is eliminated through respiratory protection.

4) Steam Generator Eddy Current Testing

In licensees following steam generator replacement, they can experience unusual high levels of loose contamination associated with eddy current testing equipment, particularly from the traversing eddy current probes, conduit and probe drivers. Despite enhancing engineering controls, handling of these components during refurbishment and probe changes is radiologically challenging from a contamination control perspective. Over time, the licensees have used power visors (blower assisted face shield), not a respirator, with mixed results. In addition some PAPR hoods were used. The Mururoa BLU would be a good fit for this work allowing workers to minimize contamination events, and improve full body cooling and peripheral vision.

5) Withdrawal and Insertion of Flux Thimbles

This is a very physical job. Workers must wear plastic suits to deal with their potential for coolant spraying from labyrinth seal fittings. Heat stress is an issue here. The Mururoa BLU would replace face-shields and plastic suits as the typical protective ensemble.

5) Pool Reactor Decontamination at PWR Sites

This is a physical job as well, that involves the use of plastics and supplied air respirators. The use of the Mururoa BLU suits would dramatically reduce accumulated dose due to set up times of hose lines, as well as reducing heat stress through advanced cooling.

In the case of decommissioning of reactors that have been in, for instance, SAFSTOR, the risk of alpha contamination is greatly increased, and the use of exceptional respiratory protection is a much needed requirement. Therefore, all activities involving reactor decommissioning where there is a risk of radioactive contamination are areas where the suits would benefit the user. In addition, it eliminates the safety concern regarding hose line hazards. In addition, hose line set up times are eliminated which saves dose and time.

4.0 Delta Protection Quality Assurance Program

In order to insure an acceptable level of quality in our products and processes, the Delta Protection program involves a series of events and quality processes that are extensive in nature. The initial steps are that the products must be certified to meet with the standards which have been established by the notified body. The products must be certified to the CE standards as established by IRSN. There are several European notified bodies that are capable of performing the tests related to the standards that have been established. In the case of the Mururoa BLU suits, "BIA" of Germany was asked to perform the tests since the BLU suits involve performance requirements and testing from a combination of two standards. They were most familiar with the requirements of EN1073-1:1998 (Ventilated protective clothing against radioactive contamination), and EN 12941:1998, (Respiratory protective devices-Powered filtering devices incorporating an hood).

From a company point of view, Delta Protection is ISO 9001 registered by the (BVQI) for general quality management. Because we are manufacturing Category III PPE, we also have our own "Quality System" that insures that manufactured products are identical in quality and performance to the initial certified product by the qualified notified body (IRSN or BIA). In addition another notified body, (ASQUAL) will review, independently, on an annual basis if we are meeting with the requirements established by Delta Protection in meeting with the ISO 9001 program, the "Practical Performance Testing", as well as insuring that products are manufactured to the certified product. This verification of performance insures quality and consistency of our finished products to the end user.

5.0 REGULATORY REQUIREMENTS

5.1 Requirements of 10CFR20.1703 and Appendix A

The following regulatory requirements are relevant to this request.

10 CFR20.1703 (b) indicates that all respiratory equipment that is not certified by NIOSH must be submitted to the NRC for analysis and approval based on quantified test data.

10CFR20.1705 requires authorization from the Commission before using APF's in excess of those specified in Appendix A.

10CFR20.1703, Use of Individual Respiratory Protection Equipment, requires that if a licensee assigns or permits the use of respiratory protection equipment to limit the intake of radioactive material, (a) the licensee shall use only respiratory protection equipment that is tested and certified by NIOSH.

10CFR20.1703(b) allows that if the licensee wishes to use equipment that has not been tested or certified by NIOSH, or for which there is no schedule for testing or certification, the licensee shall submit an application to the NRC for authorized use of this equipment.

10CFR20.1705, Application for Use of Higher Assigned Protection Factors, requires that the licensee shall obtain authorization from the Commission before using assigned protection factors in excess of those specified in Appendix A to Part 20.

Therefore, based on the above requirements, Delta Protection must obtain approval for the use of the respiratory protection BLU suit and ask for assignment of a protection factor of 2000 for the suits.

6.0 TECHNICAL JUSTIFICATION

6.1 SCOPE

This request for approval of the equipment is based on the technical justification provided. In addition, the Mururoa BLU suits and similar air-line suits have been widely used in western European nuclear power plants as well as various fuel cycle applications. At present similar suits from Delta Protection have been approved by the NRC for use in commercial power plants. These are also sold in China, South Africa and South America.

The following documents prove vital in proving the performance that the suit systems can generate to the licensees, please pay specific attention to them.

- (a) Users and Maintenance Guide for the Suits and the Blowing Unit (Attachments 4 & 5)
- (b) European Standard EN 1073-1:1998 Ventilated Protective Clothing Against Radioactive Contamination (Attachment 8)
- (c) European Standard EN 12941:1998 Respiratory Protective Devices (Powered filtering Devices incorporating a hood) Attachment 9
- (d) Test Report #200323085/2120 (Attachment 3)
- (e) Certificate No's. for Mururoa BLU suits (Attachments 1 & 2)

The European Standards (Attachments 8 & 9) incorporates testing methods that marry both standards in meeting with the technical requirements of a powered air suit system. The standard EN 1073-1:1998 requires that suit material be tested for resistance to abrasion, flex cracking, puncture, blocking, tear and flammability, strength of seams, joins and assemblies, damage resistance of exhaust valves, designed flow rates internal suit pressure range of powered filtering devices, noise level and quality of the visor. According to the testing standard, workers should perform standard exercises, each wearing two different suits inside a chamber filled with a test agent (Sodium Chloride) and measure the leakages during the exercise regimen lasting approximately 20 minutes. Operating parameters are set to manufacturer's instructions. Standard exercises include walking on a treadmill at 2 mph (3 minutes), moving arms up and down above head while looking upward (3 minutes) and squatting continuously (3 minutes). To ensure worker's comfort, 2 additional practical exercises - walking at 2 mph (5 minutes) and loading a bucket with wood chips from the base of a hopper and emptying it into the opening on top (15 minutes) - should be performed by two workers at specified air flow rates.

Test Report No 200323085/2120 states that the Mururoa BLU PVC and Mururoa BLU Ethyfuze passed in all categories tested and provided a protection factor greater than 20,000. Please note that the term 'protection factor' used in the European Standard is equivalent to the 'fit factor' used in the United States and is not the same as the Assigned Protection Factor used in 10CFR20. Based on a review of the manufacturer's documentation, the Mururoa BLU suits represent a better design than the currently approved "bubble hood" and "rain suit" combination and provide better worker protection with the data supporting an APF of 2000. In addition, a self

fed suit will allow us to use advanced protection without the need of supplied air hose lines, which can be cumbersome, and performance limiting in various applications. The suits will help reduce cost in terms of dose reduction (ALARA concerns). The suits design will allow us the opportunity, as a minimum, to conduct evolutions that involve strenuous activity, in a safe and efficient manner. At the Humbolt Bay Power plant, the suits positive pressure technology and protection will assist us in insuring excellent protection for our workers considering the risks of alpha contamination. In addition, we anticipate wet environments as well which the suit is most suitable. The suits full body cooling effect will help us eliminate heat stress concerns which we are concerned with moving forward.

6.2 Suit Construction and Blowing Unit

The Mururoa BLU self fed suits meet the European Standard EN.1073-1 and the manufacturer is ISO 9001 certified. The manufacturer indicates that approximately 100,000 Mururoa style garments/suits are used by European Nuclear Power plants each year. The suits have been manufactured for nearly 30 years without incident.

The Mururoa BLU single use suits have the following desirable features that are not available in the "bubblehoods" and "rain suits" manufactured in the United States:

- 1) One piece single use suit that includes welded gloves and booties with tie straps
- 2) Fire proof (up to 65 deg C)
- 3) Made of PVC or Ethyfuge (vinyl acetate) with reinforced elbows, knees and crotch areas.
- 4) Dual zippers - metal zipper inside and plastic zipper outside
- 5) Helmet made of clear PVC material that provides distortion-free vision and large enough for wearing a headset
- 6) Welded sleeve to insert communication cable
- 7) A removable strip near the mouth that could be used for emergency breathing in case of loss of supplied air
- 8) An egress strip stretching from left arm, over the head, to right arm that is used for undressing and for self-rescue in an emergency, such as loss of supplied air
- 9) Two exhaust valves that provide ventilation, and also protect from overpressure
- 10) Very low noise level at maximum air flow
- 11) Air flow to hands, feet, face and chest.

The Mururoa BLU Self Fed Suit is powered by a Micronel Powered Air Purifying blowing unit that has been developed and application matched to the suit system. The battery powered blowing unit has the capability to run for a minimum of four (4) hours, while supplying air to the user at 600 L/min or 20 CFM. In addition, the unit can operate at a lower air flow rate of 400 L/min, or 14 CFM for longer periods of time. A warning alarm is present if the units supplied voltage is not reached (low Battery), or if the airflow is not reaching the minimum required set

point. This may happen during long usage periods around 4 hours in duration. The battery unit is capable of supporting a minimum of 500 charges. The unit uses four (4) High capacity, high efficiency (HEPA) Pro 2000 filter cartridges "PF10 P3", or Delta Protection P3 solid and liquid particle filters. No other filters are to be approved with these suits. At the present time, are designed for single use, and must be disposed of. The cartridges have to be replaced all four (4) at a time, but not necessarily after every evolution. It is up to the radiation protection department's operating procedures to decide based on the activity performed whether the filters should be changed or not. The blowing unit and battery unit are kept for future use. The primary applications consist of preventing penetration of solid and liquid particles, radioactive and toxic particles, plus microorganisms. The blowing unit is inserted into a pouch that is inside the suit, thus preventing exposure to contamination. The unit is then connected to an internal distribution network for full body cooling and respiratory protection. Noise level is kept below 75 DB. Air flows through manifolds to the chest, hands and feet. The airflow is controlled by an intelligent closed loop system that continuously checks the difference between the set point selected by the user, and the actual air flow via an airflow meter. If the airflow is higher, than the intelligent controller will tell the unit to slow down the motor speed. If the airflow is lower than the set point, then the motor will increase speed to match the airflow set point. If the controller, for some reason, becomes defective, the motor will run at it's maximum speed. There are two exhaust vents on the back - one behind the neck and one at lower back. The exhaust vents have patented magnetic seals to prevent any entry of contaminants if powered air is lost. The suit is made of non-flammable PVC or polyethylene/vinyl acetate (Ethyfuge), but should not be brought in direct contact with any material colder than 41 deg F or hotter than 140 deg F. Open flames or sparks could melt or perforate the skin. There is a shelf-life of 3 years for this suit and storage between 32 deg F and 140 deg F in original packing is required by manufacturer. All particle filters have a 10 year shelf life as indicated by the manufacturer.

6.3 Safety Features of Mururoa BLU Self Fed Suits

The Mururoa BLU suits models are light-weight (2.5 lbs), made of fire-retardant material and can be used in temperatures up to 140 deg F. Contact with open flames or grinding/welding sparks is prohibited. Built-in gloves, booties with binding ties, reinforced elbows, knees and crotch protect against accidental tear, puncture and cracking. A transparent helmet with 6" X 8" clear face plate provides distortion-free view. Dual magnetic ventilation valves provide needed ventilation and relief of excess pressure in case suit is squeezed/pinched unexpectedly. In case of loss of air, the user can remove the mouth strip and move the opening close to his face, or enlarge the opening, to breathe outside air. Alternately, the user can pull the escape strip from either forearm, over the head and towards the other forearm, and rip the suit in two halves. This escape strip is normally used for egress from the suit when the work activity has been completed.

The Mururoa BLU suit's design does not permit its use in an immediately dangerous to life and health (IDLH) atmosphere. Applications involve the use of the suit for protection against solid and liquid particles, radioactive, and toxic particles and microorganisms. The Mururoa BLU self-fed suits are also not designed for use with any personal cooling units such as a Vortex tube, but can be used with a cooling vest supplied by the manufacturer, if desired.

6.4 Implementation

All licensees should have a respiratory program in full compliance with 10CFR20. The Mururoa BLU self fed suits will be integrated into the plants respiratory program using the information provided by the manufacturer. New lesson plans will be developed to train workers on Mururoa BLU's features, donning, use and removal, cautions and use of mouth strip and tear off strips for routine and emergency egress. Radiation Protection personnel will be provided additional training for selection, approval, issue, equipment set-up, operation and maintenance instructions for the Mururoa BLU suit. The Mururoa BLU suit's safety features, namely the tear-off mouth strip and the emergency tear-off strip, make it unnecessary for any standby rescue person. Further justification for eliminating the rescue person provision include the fact that workers wearing suits are typically under continuous surveillance by Radiation Protection technicians using remote video monitoring or under direct Radiation Protection surveillance at the job location due to radiological conditions. The ability to eliminate the rescue worker is also an ALARA consideration since the work areas where powered air-supplied suits are used are typically areas with higher radiation and contamination levels. Cavity decon, equipment decon are specifically targeted for the use of the Mururoa BLU self fed suit. These areas would benefit by the elimination of air -lines, which may be a hindrance to overall outage performance. licensees will use their internal processes to document any unexpected problems and track corrective actions taken. **Problems associated with the suits will be communicated to the manufacturer to ensure that operating experience is shared with other users.** A relationship with the manufacturer will also be developed that allows operating experience from other users to be incorporated into another licensees processes. Delta Protection has in place a vendor-user alert system so as to report any deviations, or deficiencies within the product and manufacturing process should they arise. The manufacturer is subjected to checks from the IPSN to insure the product has no risk of injury to the user. A second organization called ASQUAL performs annual inspections of the factory to certify that the product manufactured is of the same quality approved by the IPSN Notified Body. Several destructive/non-destructive tests are performed by the manufacturer for each order received from clients. Any defects reported by clients, investigations and corrective actions are documented. Customers are notified of any problems and products are recalled if necessary. This information is made available to ASQUAL for their annual inspections. **The plants will document and report any peculiarities, or defects in the products performance, and will report back to the NRC.**

At present many licensees currently uses the bubble hood or PAPH for jobs involving high potential for skin contamination from discrete radioactive particles and to prevent intake of airborne contaminates. Because the bubble hood covers only the face and torso, workers have to wear protective clothing, 2 pairs of gloves, rubber shoes and cotton booties and tape for sealing. Chances of cross contamination during undressing/exit from contaminated areas are high. The Mururoa BLU self fed suits offer a better alternative (with their unitized construction and ease of removal) and should protect the worker much better against facial/skin contamination and airborne radioactivity, as well as allowing the worker complete freedom of movement, thus eliminating air lines. Approval of a protection factor of 2000 for the Mururoa BLU self suits would allow use of the in it's efforts to control contamination incidents and prevent intakes during operational activities at all nuclear power plants, gaseous diffusion plants, and decommissioning sites under NRC jurisdiction..

6.5 Conclusion

Based on the information submitted by Delta Protection, we feel that the MURUROA BLU PVC and Mururoa BLU Ethyfuge self fed single use suits offer a safer and more efficient means to protect workers in areas of high radiological contamination and in areas where there is a potential for airborne contamination. The existing rain suits and bubblehoods, and powered air purifying devices provide cooling only to the head and force workers to wear the ensemble in a manner that makes self-rescue nearly impossible, thus requiring a rescue worker to be stationed nearby. Ease of removal of the Mururoa BLU suits provide for more desirable self-rescue features, and provides a means to undress that minimizes the potential for personnel contamination events. In addition, the powered air approach enables us to move free and clear, thus ridding ourselves of the undesirable task of running hose lines within the work environment, a source for increased collective dose. In addition, full body cooling in a one of a kind suit while minimizing heat stress and improving operator efficiency, will definitely have an impact on overall worker efficiency. We feel that the Mururoa suit systems are in the best interest of ALARA principles and will offer distinctive occupational health and safety benefits. Pursuant to 10CFR20.1703(b), Delta Protection is hereby requesting authorization to use the recently evaluated Mururoa BLU self fed suits respiratory protection equipment and suits that are manufactured in France. Pursuant to 10CFR20.1705, Delta Protection is also requesting authorization and approval to use an APF of 2000 with the Mururoa BLU self fed suits. The tests along with a review of the manufacturer's documentation have shown that these suits provide better design and protection that supports the requested APF. Additionally, the suits have advanced safety features for emergency breathing and emergency escape. These advanced features allow self rescue during emergencies to be a reasonable expectation.

We request that Both the Mururoa BLU PVC and Mururoa BLU Ethyfuge suits receive approval and are assigned a protection factor of 2000. Furthermore, that the suits be approved for use with both Scott PF10 P3, and Delta Protection P3 filters. In addition, we request that the operating levels be made available to users at both 400 litres/minute and 600 Litres/minute based on proven test methods of performance.

Testing and Certificate Bodies
in the BG-PRÜFZERT
*[testing and certification system of
the professional associations]*



BIA

Berufsgenossenschaftliches
Institut für Arbeitsschutz

European notifying bodies
Identification number 0121

[BG-Institute for occupational safety and health]

EC Type Examination Certificate

0401119

Certificate number

Name and address of the certificate holder:
(Customer) Delta Protection
Z.A. du Berret
30200 Bagnols-sur-Ceze / France

Name and address of the manufacturer: Delta Protection
Z.A. du Berret
30200 Bagnols-sur-Ceze / France

Reference of the client: Reference of the testing and certificate bodies: Date of issue:
PP/Rö/Tob 15.10.2004

Specimen tested: One-piece ventilated protective suit with exhaust valves, fan and filters

Version: **Mururoa Blu PVC**

Intended use: Protective suit for air borne (radioactive) particles for single use
Class 4 protection factor rating as per (EN 1073-1:1998); device class TH3 PSL
as per (EN 12941:1998)
Minimum turbine operating time with fully charged battery: 4 hours

Basis of Testing: DIN EN 340
DIN EN 1073-1:1998
DIN EN 12941:1998

Remarks: This document is valid in connection with the report concerning the EC type examination no. 200423162 from 15. October 2004 – BIA, Sankt Augustin

The tested type is conform with the applicable regulations of the guide lines 89/686/EEC (personal safety equipment), changed through the guide lines 93/68/EEC, 93/95/EEC and 96/58/EC.

Further conditions will be regulated by the testing and certification regulations from April 2004.

Director of the certificate bodies
<<Signature illegible>>
(Prof. Dr. rer. nat. Dietmar Reinert)

Certification officer
<<Signature illegible>>
(Dr.-Ing. Horst Kleine)

Postal address: 53754 Sankt Augustin
Address: 53757 Sankt Augustin
Alte Heerstraße 111
Telephone: +49 (0) 2241/231-02
Fax: +49 (0) 2241/231-2234



BIA

Berufsgenossenschaftliches Institut für Arbeitsschutz
[BG-Institute for occupational safety and health]

REPORT ON EC TYPE EXAMINATION NO. 200423162

- Valid in connection with EC type examination certificate no. 04 01119 from 15.10.2004

1 Testing of the type

Within the scope of the EC type examination the basic requirements for health protection and safety to the required extent as determined in Annex II of the EC guidelines 89/686/EEC, and as applied for by the manufacturer of the personal protection equipment in his

- testing application from 26.06.2003

were tested.

2 Examination of the technical documents of the certificate holder

Within the scope of the EC type examination

- The technical manufacturing documentation according to annex III of the EC guidelines 89/686/EEC and the
- Information brochure of the manufacturer according to annex II of the EC guidelines 89/686/EEC were looked through and were considered appropriate regarding to the basic requirements of these guidelines.

3 Annexes

The following documentations are part of the EC type examination:

- 3.1 Test report no. 200322218/2160 from 07.10.2004, BIA, Sankt Augustin
- 3.2 Test report no. 200323085/2120 from 18.06.2004, BIA, Sankt Augustin
- 3.3 Test report no. 1248 from 14.06.2004, Institut Textil de France
- 3.4 Technical documentation, provided with the endorsement of the BIA no. 200423162

Sankt Augustin, 15.10.2004

PP/Rö/HD

<<Signature: H. Kleine>>

Dr.-Ing. Horst Kleine

Home address: Tel.: +49 (0) 2241 231-02
Alte Heerstraße 111 Fax: +49 (0) 2241 231-22 34
53754 Sankt Augustin Email: bia@hvb.de
Germany www.hvb.de/bia

Please address letters to the
Institute and not to
individuals.



Date: 07.10.2004

TEST REPORT

No.: 200322218/2160

- | | |
|-------------------------|--|
| 1 Customer | Delta Protection
Z. A. du Berrett
30200 Bagnols sur Ceze - France |
| 2 Test specimen | Contamination protection suit |
| 2.1 Manufacturer | Delta Protection
Z. A. du Berrett
30200 Bagnols sur Ceze - France |
| 2.2 Type, designation | Ventilated protection suit |
| Marking | Mururoa Blu PVC |
| 2.3 Intended use | Ventilated protection clothing for single use against
radioactive contamination |
| 2.4 Date of manufacture | -,- |
| 2.5 Miscellaneous | of the manufacturer:
colour: Pink
basic material: PVC (9013 A, 20/100) |

6 General remarks

The present Test Report consists of

7

Pages.

Pages 1 to 3 indicate the overall test result. The complete Test Report also includes the test protocol, containing all pertinent details.

The present Test Report does not warrant the use of the GS-label, BG-label or CE-mark.

In all other respects the Rules of Procedure for Testing and Certification carried out by the Test and Certifications Bodies in *BG-PRÜFZERT* shall apply in conjunction with the General Business Conditions of the Hauptverband der gewerblichen Berufsgenossenschaften e.V.

For the assessment:

For the testing:

<<Signature illegible>>

<<Signature illegible>>

Dr. Peter Paszkiewicz

Dip. Ing. Gerda Röckel-Schütze

Certification officer

Head of Test laboratory

Test protocol

- 1 BASIS OF TESTING:** DIN EN 1073-1:1998 table 1 (without flame resistance) and section 4.4.1
- 2 TYPE OF TESTING:** Type examination
- 3 CUSTOMER:** Delta Protection
- 4 TEST SPECIMEN**
- 4.1 Version: ventilated protection suit for single use
colour: white
- 4.2 Designation: **Mururoa Blu PVC**
- 4.3 Identification: **Mururoa Blu PVC**
- 5 TESTING**
- 5.1 Materials
- 5.1.1 *Abrasion resistance*
- Test method: DIN EN 530 method 2
Abrasion agent 00 (BS 871) with 9 kPa surface pressure
- 5.1.2 *Perforation resistance*
- Test method: DIN EN 863 : 1995
- 5.1.3 *Tear resistance*
- Test method: EN ISO 9073-4 : 1997
- 5.1.4 *Flame resistance:* Not applicable

This Test Protocol must only be published in full wording and in connection with pages 1 to 3 of the Test Report.

The test results apply to the tested object only.



6 REQUIREMENTS - TEST RESULTS**6.1 Abrasion resistance****6.1.1 Requirement**

The test results for abrasion resistance are classified in the following levels of performance:

Level of performance	Number of cycles
1	> 10
2	> 100
3	> 500
4	> 1000
5	> 1500
6	> 2000

At least **performance level 1** must be obtained.

6.1.2 Test result

Material	Number of obtained cycles
PVC ROSE 9013 A-20/100	> 2000

The suit must be assigned to **performance level 6**.

The requirement is met.

6.2 Perforation resistance**6.2.1 Requirement**

The test results for perforation resistance are classified in the following levels of performance:

Level of performance	Perforation resistance [N]
1	> 10
2	> 50
3	> 100

At least **performance level 1** must be obtained.

This Test Protocol must only be published in full wording and in connection with pages 1 to 3 of the Test Report.

The test results apply to the tested object only.



6.2.2 Test result

Material / Specimen	Perforation resistance [N]
PVC ROSE 9013 A-20/100	12.4

The suit must be assigned to **performance level 1**.

The requirement is met.

6.3 Tear resistance

6.3.1 Requirement

The test results for tear resistance are classified in the following levels of performance:

Level of performance	Tear resistance [N]
1	> 2
2	> 10
3	> 20
4	> 40
5	> 80
6	> 150

At least **performance level 1** must be obtained.

6.3.2 Test result

Material / Specimen	Tear resistance [N]	
	in longitudinal direction	in cross direction
PVC ROSE 9013 A-20/100	38.0	26.3

For the classification into the performance level the lowest value must be used.

The suit must be assigned to **performance level 4**.

The requirement is met.

6.3 Flame resistance: Not applicable

This Test Protocol must only be published in full wording and in connection with pages 1 to 3 of the Test Report.

The test results apply to the tested object only.



6.5 Seam strength

6.5.1 Requirement

The test results for seam strength are classified in the following levels of performance:

Level of performance	Seam strength [N]
1	> 30
2	> 50
3	> 75
4	> 125
5	> 300

At least **performance level 1** must be obtained.

6.5.2 Test result of the seam

Seam	Seam strength [N]	Remarks
Seam type 1	148	Tear at the clamp
Seam type 2	156	Tear at the clamp

The suit must be assigned to **performance level 4**.

The requirement is met.

6.5.3 Test result of the emergency exit

The test result of the seam was at least obtained.

Berufsgenossenschaftliches
Institut für Arbeitsschutz – BIA
On behalf of

<<Signature illegible>>
Dipl.-Ing. Gerda Röckel-Schütze

This Test Protocol must only be published in full wording and in connection with pages 1 to 3 of the Test Report.

The test results apply to the tested object only.



Testing and Certificate Bodies
in the BG-PRÜFZERT

[testing and certification system of
the professional associations]

European notifying bodies
Identification number 0121



BIA

Berufsgenossenschaftliches
Institut für Arbeitsschutz

[BG-Institute for occupational safety and health]

EC Type Examination Certificate

0401120

Certificate number

Name and address of the certificate holder:
(Customer) Delta Protection
Z.A. du Berret
30200 Bagnols-sur-Ceze / France

Name and address of the manufacturer:
Delta Protection
Z.A. du Berret
30200 Bagnols-sur-Ceze / France

Reference of the client: Reference of the testing and certificate bodies: Date of issue:
PP/Rö/Tob 15.10.2004

Specimen tested: One-piece ventilated protective suit with exhaust valves, fan and filters

Version: **Mururoa Blu Ethyfuge**

Intended use: Protective suit for air borne (radioactive) particles for single use
Class 4 protection factor rating as per (EN 1073-1:1998); device class TH3 PSL
as per (EN 12941:1998)
Minimum turbine operating time with fully charged battery: 4 hours

Basis of Testing: DIN EN 340
DIN EN 1073-1:1998
DIN EN 12941:1998

Remarks: This document is valid in connection with the report concerning the EC type examination no. 200423163 from 15. October 2004 – BIA, Sankt Augustin

The tested type is conform with the applicable regulations of the guide lines 89/686/EEC (personal safety equipment), changed through the guide lines 93/68/EEC, 93/95/EEC and 96/58/EC.

Further conditions will be regulated by the testing and certification regulations from April 2004.

Director of the certificate bodies
<<Signature illegible>>
(Prof. Dr. rer. nat. Dietmar Reinert)

Certification officer
<<Signature illegible>>
(Dr.-Ing. Horst Kleine)

Postal address: 53754 Sankt Augustin
Address: 53757 Sankt Augustin
Alte Heerstraße 111

Telephone: +49 (0) 2241/231-02
Fax. +49 (0) 2241/231-2234



BIA

Berufsgenossenschaftliches Institut für Arbeitsschutz
[BG-Institute for occupational safety and health]

REPORT ON EC TYPE EXAMINATION NO. 200423163

- Valid in connection with EC type examination certificate no. 04 01120 from 15.10.2004

1 Testing of the type

Within the scope of the EC type examination the basic requirements for health protection and safety to the required extent as determined in Annex II of the EC guidelines 89/686/EEC, and as applied for by the manufacturer of the personal protection equipment in his

- testing application from 26.06.2003

were tested.

2 Examination of the technical documents of the certificate holder

Within the scope of the EC type examination

- The technical manufacturing documentation according to annex III of the EC guidelines 89/686/EEC and the
- Information brochure of the manufacturer according to annex II of the EC guidelines 89/686/EEC were looked through and were considered appropriate regarding to the basic requirements of these guidelines.

3 Annexes

The following documentations are part of the EC type examination:

- 3.1 Test report no. 200322219/2160 from 07.10.2004, BIA, Sankt Augustin
- 3.2 Test report no. 200323085/2120 from 18.06.2004, BIA, Sankt Augustin
- 3.3 Test report no. 1248 from 14.06.2004, Institut Textil de France
- 3.4 Technical documentation, provided with the endorsement of the BIA no. 200423163

Sankt Augustin, 15.10.2004

PP/Rö/HD

<<Signature: H. Kleine>>

Dr.-Ing. Horst Kleine

Home address: Tel.: +49 (0) 2241 231-02
Alte Heerstraße 111 Fax: +49 (0) 2241 231-22 34
53754 Sankt Augustin Email: bia@hvbg.de
Germany www.hvbg.de/bia

Please address letters to the
Institute and not to
individuals.



Date: 07.10.2004

TEST REPORT

No.: 200322219/2160

1 Customer	Delta Protection Z. A. du Berrett 30200 Bagnols sur Ceze - France
2 Test specimen	Contamination protection suit
2.1 Manufacturer	Delta Protection Z. A. du Berrett 30200 Bagnols sur Ceze - France
2.2 Type, designation	Ventilated protection suit
Marking	Mururoa Blu ETHYFUGE
2.3 Intended use	Ventilated protection clothing for single use against radioactive contamination
2.4 Date of manufacture	-,-
2.5 Miscellaneous	of the manufacturer: colour: white basic material: PE (Ethyfuge 2000, 24/100)

6 General remarks

The present Test Report consists of

7

 Pages.

Pages 1 to 3 indicate the overall test result. The complete Test Report also includes the test protocol, containing all pertinent details.

The present Test Report does not warrant the use of the GS-label, BG-label or CE-mark.

In all other respects the Rules of Procedure for Testing and Certification carried out by the Test and Certifications Bodies in *BG-PRÜFZERT* shall apply in conjunction with the General Business Conditions of the Hauptverband der gewerblichen Berufsgenossenschaften e.V.

For the assessment:

For the testing:

<<Signature illegible>>

<<Signature illegible>>

Dr. Peter Paszkiewicz

Dip. Ing. Gerda Röckel-Schütze

Certification officer

Head of Test laboratory

Test protocol

- 1 BASIS OF TESTING:** DIN EN 1073-1:1998 table 1 (without flame resistance) and section 4.4.1
- 2 TYPE OF TESTING:** Type examination
- 3 CUSTOMER:** Delta Protection
- 4 TEST SPECIMEN**
- 4.1 Version: ventilated protection suit for single use
colour: white
- 4.2 Designation: **Mururoa Blu ETHYFUGE**
- 4.3 Identification: **Mururoa Blu ETHYFUGE**
- 5 TESTING**
- 5.1 Materials
- 5.1.1 *Abrasion resistance*
- Test method: DIN EN 530 method 2
abrasion agent 00 (BS 871) with 9 kPa surface pressure
- 5.1.2 *Perforation resistance*
- Test method: DIN EN 863 : 1995
- 5.1.3 *Tear resistance*
- Test method: EN ISO 9073-4 : 1997
- 5.1.4 *Flame resistance:* Not applicable

This Test Protocol must only be published in full wording and in connection with pages 1 to 3 of the Test Report.

The test results apply to the tested object only.



6 REQUIREMENTS - TEST RESULTS

6.1 Abrasion resistance

6.1.1 Requirement

The test results for abrasion resistance are classified in the following levels of performance:

Level of performance	Number of cycles
1	> 10
2	> 100
3	> 500
4	> 1000
5	> 1500
6	> 2000

At least **performance level 1** must be obtained.

6.1.2 Test result

Material	Number of obtained cycles
ETHYFUGE 2000-24/100	> 2000

The suit must be assigned to **performance level 6**.

The requirement is met.

6.2 Perforation resistance

6.2.1 Requirement

The test results for perforation resistance are classified in the following levels of performance:

Level of performance	Perforation resistance [N]
1	> 10
2	> 50
3	> 100

At least **performance level 1** must be obtained.

This Test Protocol must only be published in full wording and in connection with pages 1 to 3 of the Test Report.

The test results apply to the tested object only.



6.2.2 Test result

Material / Specimen	Perforation resistance [N]
ETHYFUGE 2000-24/100	24.8

The suit must be assigned to **performance level 1**.

The requirement is met.

6.3 Tear resistance

6.3.1 Requirement

The test results for tear resistance are classified in the following levels of performance:

Level of performance	Tear resistance [N]
1	> 2
2	> 10
3	> 20
4	> 40
5	> 80
6	> 150

At least **performance level 1** must be obtained.

6.3.2 Test result

Material / Specimen	Tear resistance [N]	
	in longitudinal direction	in cross direction
ETHYFUGE 2000-24/100	70.2	67.2

For the classification into the performance level the lowest value must be used.

The suit must be assigned to **performance level 4**.

The requirement is met.

6.3 Flame resistance: Not applicable

This Test Protocol must only be published in full wording and in connection with pages 1 to 3 of the Test Report.

The test results apply to the tested object only.



6.5 Seam strength

6.5.1 Requirement

The test results for seam strength are classified in the following levels of performance:

Level of performance	Seam strength [N]
1	> 30
2	> 50
3	> 75
4	> 125
5	> 300

At least **performance level 1** must be obtained.

6.5.2 Test result of the seam

Seam	Seam strength [N]	Remarks
Seam type 1	79	Tear at the clamp
Seam type 2	81	Tear at the clamp

The suit must be assigned to **performance level 3**.

The requirement is met.

6.5.3 Test result of the emergency exit

The test result of the seam was at least obtained.

Berufsgenossenschaftliches
Institut für Arbeitsschutz – BIA
On behalf of

<<Signature illegible>>
Dipl.-Ing. Gerda Röckel-Schütze

This Test Protocol must only be published in full wording and in connection with pages 1 to 3 of the Test Report.

The test results apply to the tested object only.



Testing and Certificate Bodies
in the BG-PRÜFZERT

*[testing and certification system of the
professional associations]*



BIA

Berufsgenossenschaftliches
Institut für Arbeitsschutz
[BG-Institute for occupational safety and health]

Date : **18.06.2004**

TEST REPORT

No. 200323085/2120

- | | | |
|------------|-----------------------------|--|
| 1 | Requested by | Delta Protection
Z. A. du Berret
30200 Bagnols-sur-Ceze France |
| 2 | Specimen tested | Fan-assisted ventilated contamination protection garment |
| 2.1 | Manufacturer | Delta Protection
Z. A. du Berret
30200 Bagnols-sur-Ceze |
| 2.2 | Type and description | Protective suit with exhaust valves, filters and fan
Mururoa Blu Ethyfuge and Mururoa Blu PVC |
| | Description | Protective suit: Mururoa Blu Ethyfuge
Mururoa Blu PVC |
| | | fan : C500X-012ER-A B60
battery : C501A-012AK-A
charger : Micronel C510L-230XX-A
filter : Scott PF 10
Delta Protection P3 |
| 2.3 | Purpose | Protective garment offering contamination protection with
turbine and four particle filters
Class 4 protection factor rating as per EN 1073-1: 1998
Device class TH3 PSL as per EN 12941: 1998
Minimum turbine operating time with the battery charged:
4 hours |
| 2.4 | Date of manufacture | 2003 |
| 2.5 | Miscellaneous | .-. |

The test protocol with detailed information is part of the test report.

This test report DOES NOT ENTITLE the manufacturer to use the GS mark, the BG mark or the CE mark.

Besides, regulations relating to the tests and certifications by test and certification centres within BG-PRÜFZERT are applicable, in association with the general terms of "Hauptverband der gewerblichen Genossenschaften e. V".

For the appreciation:

For the test:

Hans-Ulrich Tobys, Engineer

Certified professional

b. o. Claudia Lietz

Director of the test laboratory

Test protocol

1. **Test based on:** EN 1073-1: 1998 and EN 12941: 1998
2. **Type of test:** Construction type test
3. **Requested by:** Delta Protection
4. **Test specimen**
 - 4.1 **Version:** Protective suit with exhaust valves, filters and fan
 - 4.2 **Description:** **Mururoa Blu Ethyfuge or Mururoa Blu PVC**
 - 4.3 **Identification:** Protective garment: Mururoa Blu Ethyfuge
Mururoa Blu PVC

Fan	: C500X-012ER-A B60
Battery	: C501A-012AK-A
Charger	: Micronel C510L-230XX-A
Filter	: Scott PF 10 Delta Protection P3
 - 4.4 **Device class:** TH3 PSL
 - 4.5 **Number of filters:** The tests were performed with the respiratory protection device running, fitted with four filters.

5. Device version

The fan-assisted ventilated contamination protection garment with four respiratory protection filters comprises a protective Mururoa Blu Ethyfuge or Mururoa Blu PVC suit in sizes 3 and 4 and a Delta Protection C500 fan.

The Mururoa Blu Ethyfuge and Mururoa Blu PVC protective garments have a similar design, other than the material of the suit, and they have similar wearing properties.

The two variants of the protective garment were tested as part of the procedure.

The rated output volume of the ventilation device can be set to either 400 l/min or 600 l/min.

The minimum operating time of the fan is four hours when the battery is fully charged.

All the tests were performed in the severest conditions claimed by the manufacturer.

According to the manufacturer, the particle filters mentioned in point 2.2 can be used indifferently.

Only identical filter types may be used. When the filters are replaced, the four filters need to be changed at the same time.

6. Mechanical strength

Before the tests on the filters, the filters were subjected to a mechanical strength test as per EN 12941: 1998, paragraph 7.11.

The tests were conducted on Mururoa Blu Ethyfuge or Mururoa Blu PVC protective suits.

The requirements were met.

7. Thermal strength

7.1 Requirement

The overall device and the two specimens of each type of tested filter are to be stored in accordance with the storage conditions recommended by the manufacturer for (72 ± 1) hours respectively after being exposed to extreme temperature and humidity values.

At the end of the storage time, there shall be no significant deformation of the main components of the device and the components shall not come off from the device.

7.2 Conditioning

Conditioning was in accordance with the manufacturer's storage conditions, at a temperature of 30 °C (75 % humidity) and -10 °C.

The conditioned device was then subjected to visual inspection.

The device was subsequently assessed as part of the test.

The tests were performed with Mururoa Blu Ethyfuse and Mururoa Blu PVC protective suits.

The thermal strength requirements applicable to the respiratory protection device were met.

8. Alert and checking systems

8.1 Requirements

Systems shall be provided to directly or indirectly check if the set rated output volume is reached.

TH2 and TH3 class devices shall have an alert system if the output volume is too low.

If a low output alert system is provided, the manufacturer shall provide a means to check if it is operating.

8.2 Test results

For checking the operating of the air supply unit and its alert system function, the electronic alert system integrated into the blowing system was used.

When the blowing system is started up, the operating of the alert system in the device is verified and reported by a sound signal lasting approximately 2 seconds. According to the manufacturer, the alert system is triggered when the minimum operating conditions are no longer met.

The alert systems were tested as delivered and after storage at certain temperatures.

With the two settings of the rated output volume, the alert system is triggered at a battery voltage of 10.4 volts.

The output volume at the alert system triggering limit was determined during a resistance alert (increase in filter resistance) and a voltage alert (drop in the power supply voltage).

With the two settings of the rated output volume, the relevant rated output volume was reached.

The requirements were met.

9. Air supply and duration of use

9.1 Setting of the rated output volume: 600 l/min

9.2 Minimum blower operating time: 4 hours (manufacturer's claim)

9.3 Requirement

The tests are to be performed with the battery fully charged, new filters, suit closed.

The tests are to be performed with the type of filter offering the greatest hydrodynamic resistance.

After the stated usage time, the rated output volume must be reached when the setting of the rated output volume is at its maximum value of 600 l/min.

9.4 Test result

The blowing systems were tested as delivered and after storage at certain temperatures.

Rated output volume [l/min]	Q _(0 h) [l/min]	Q _(4 h) [l/min]	U _{AL} [V]	U _{min} [V]
600	618	609	10.4	10.6
600	613	604	10.4	10.7

Avec Q_(0 h) = initial output volume

Q_(4 h) = output volume after four hours of operation

U_(AL) = alarm system battery voltage with the cover open

U_(min) = minimum battery voltage determined after four hours of operation

The rated output volume of 600l/min was reached after the minimum operating time of four hours.

The requirements were met.

10. Dust accumulation capacity

10.1 Dust is accumulated by means of new filters and a fully charged battery on a Sheffield feeler connected to an artificial lung with an output volume per minute of 30 l/min (20 lifts/min, 1/5 l/min, sinusoidal).

The filter and blower are exposed to the test atmosphere.

The test dust is dolomitic dust as per EN 143.

With devices with blower filters of the H3 device class and (400 ± 100) mg/m³ dust concentration, dust is accumulated till the product of the dust concentration and the test time reaches 200 mg*h/m³ for particle filters and 100 mg*h/m³ for combined filters.

10.2 Requirement

The minimum output volume shall be reached after dust accumulation.

The tests shall be performed at the maximum setting of the rated output volume of 600 l/min.

The filters used during the accumulation shall meet the requirements in respect of the degree of transmission of particle filters.

10.3 Test results

Conditioning	Scott PF10	Delta Protection P3
Dust concentration [mg/m ³]	428	435
Accumulation value [mg*h/m ³]	214	216
Initial output volume [l/min]	605	618
Output volume after accumulation [l/min]	600	600

The rated output volume was reached.

The requirements were met.

11. Resistance to respiration**11.1 Requirement**

The maximum expiration resistance with the blower operating and an expiration output volume of 160 l/min shall never exceed 500 Pa.

The test shall be performed with the type of filter offering the least aerodynamic resistance.

The tests shall be performed at the maximum rated output volume setting of 600 l/min.

11.2 Test results

Filter	Delta P3	Scott PF10
Resistance to expiration [Pa]	172 - 187	179 - 204

The tests were performed on Mururoa Blu Ethyfuse and Mururoa Blu PVC protective suits.

The requirement was met.

12. Filter permeation degree [D]**12.1 Requirements**

Maximum filter permeation degree 0.2 %

12.2 Output volume: 150 l/min

12.3 Type of test

Test of the degree of permeation of individual filters

12.4 Test results

Test	Filter Conditioning	Scott PF10		Delta Protection P3	
		D-NaCl [%]	D-oil [%]	D-NaCl [%]	D-oil [%]
1	As per point 6	0.004	0.004	0.004	<0.005
2	As per point 6	0.004	0.003	0.005	0.006
3	As per points 6 and 7	0.006	0.003	0.007	0.0040
4	As per points 6 and 7	0.004	0.006	0.005	0.002
5	After accumulation	0.004	0.004	0.002	0.004

The requirements were met.

13. Multiple filters

If the device has several filters through which part of the total output volume flows, the output volume through each filter shall be equal.

This requirement is deemed to be met by multiple filters where the maximum difference in the aerodynamic resistance of the filters used is ≤ 0.2 in relation to the mean aerodynamic resistance.

The requirement was met by the filters of the system.

14. Flame resistance

After removal from the flame, no part of the safety system shall continue to burn. The tests were performed with Mururoa Blu Ethyfuge and Mururoa Blu PVC protective suits.

The requirements were met.

15. Strength of the supply tube and joints

As no unprotected supply tube is used in the protective suit, this test is irrelevant.

16. Resistance to crushing of the supply tube

As no unprotected supply tube is used in the protective suit, this test is irrelevant.

17. Connections and interconnections (4.4.2 EN 1073-1: 1998)

Connections and interconnections between the suit and removable elements such as sleeves and gloves or between shoes and trouser legs shall withstand a tensile force of 100N. The tests were performed with Mururoa Blu Ethyfuge and Mururoa Blu PVC protective suits.

The requirements were met.

18. Strength of the helmet visor

The helmet of the Mururoa Blu Ethyfuge safety suit is worn in the same way as on the person and placed on a feeler with the centre line horizontal.
A steel ball (D = 22 mm, m = 44g) is dropped on the middle of the visor from a height of 130 cm.

After an impact perpendicular to the surface, the visor shall show no visible damage. The tests were performed with Mururoa Blu Ethyfuge and Mururoa Blu PVC protective suits.

The requirement was met.

19. Noise generated**19.1 Requirement**

The noise of the fan shall not exceed 75 dB(A).
The tests shall be performed at the maximum rated output volume setting of 600 l/min.

19.2 Test result

Sound at the ears of the wearer of the device: 70.5 dB(A)

The requirement was met.

20. Exhaust system / exhaust valves**20.1 The exhaust valves shall be protected from soiling and mechanical damage.**

The requirement was met.

20.2 The exhaust valves shall be in perfect working order after being subjected to a continuous expiration air output of 600 l/min for 60 s.

The requirement was met.

20.3 The casing of the exhaust valves shall be fitted on the respiratory connection so as to withstand an axial tensile force of 50 N for 10 seconds.

The requirement was met.

21. Internal leaks**21.1 Test conditions**

Conveyor belt speed:	5 km/h
Exercise time:	2 min
Air intake speed:	2 m/s
Types of exercise:	E 1 = standing E 2 = walking E 3 = walking while speaking E 4 = raising the arms E 5 = bending the knees

In addition to the exercises under EN 1073-1: 1998, the exercises that are critical for protective suits under EN 12941:1998 (walking while speaking) were performed. When the suit is closed, exercises with side draughts are not needed.

21.2 Requirements relating to class 4 under EN 1073-1: 1998

Internal leaks shall not exceed 0.01 % in any exercise.

The leak shall not exceed a mean value (MW) of 0.005 % in any test.

21.3 Requirements relating to class TH3 under EN 12941: 1998

Internal leaks shall not exceed 0.2% in any exercise or test.

21.4 Test performance

The tests were performed at the minimum rated output volume setting, i.e. 400 l/min. Persons 6, 7, 9 and 10 who were subjected to the test wore the respiratory protective system as delivered and persons 1 to 5 and 8 wore the respiratory protective system after storage at certain temperatures.

Tests 3 to 7 were performed with the Mururoa Blu Ethyfuse protective suit and tests 1, 2 and 8 to 10 were performed with the Mururoa Blu PVC protective suit.

The results of tests 1 to 10 were determined with an NaCl aerosol.

21.5 Test results

Exercise	Test / Person subjected to the test									
	1/1	2/2	3/3	4/4	5/5	6/6	7/7	8/8	9/9	10/10
1	0.003	0.002	<0.001	<0.001	0.002	0.003	<0.001	0.002	0.002	0.002
2	0.003	0.003	0.002	0.004	0.002	0.003	0.005	0.003	0.002	0.004
3	0.004	0.001	0.002	0.004	0.003	0.004	0.003	0.003	0.002	0.004
4	0.003	0.007	0.003	0.009	0.004	0.009	0.004	0.002	0.001	0.004
5	0.002	0.007	0.003	0.009	0.004	0.009	0.004	0.002	0.001	0.004
MW	0.003	0.002	0.002	0.003	0.002	0.003	0.003	0.003	0.002	0.003

The requirements were met.

22. Pressure in the suit (4.12 EN 1073-1: 1998)**22.1 Requirements**

Positive pressure shall not exceed 1000 Pa on average and 2000 Pa as the peak value.

Positive pressure shall be maintained.

Tests shall be performed at the maximum setting of the rated output volume, i.e. 600 l/min.

Tests shall be analogous to those mentioned in point 21.1.

22.2 Test results (pressure in Pa)

Test/Person	Exercise				
	1	2	3	4	5
1	170 - 180	130 - 200	120 - 240	120 - 220	40 - 300

The requirement was met.

23. Practical performance test

For the practical performance test:

- the Mururoa Blu Ethyfrage protective suit was assessed with tests 1 and 2
- and the Mururoa Blu PVC protective suit was assessed with performance test 3 subjectively by wearers of the device as provided in EN 12941: 1998.

23.1 Assessment by wearers of device 1

Putting on and taking off:	second person required
Accessibility of all control systems:	no remark
Weight distribution:	no complaint
Safety of connecting pieces and connections:	no complaint
Resistance to fogging of the sight window:	no complaint
Visual distortion through the sight window:	no complaint
Field of vision:	no complaint
Recognition of characters (150 mm at 6 m)	legible
Understanding with a supervisor:	no complaint
Distribution of the weight of the worn device:	no complaint
Accidental switching on and off:	no complaint
Influence of the air output volume:	no complaint
Fitness of the alert system:	adequate alert signal
Freedom of movement of the head:	no complaint
Comfortable for the wearer:	no complaint
Additional information:	none

23.2 Assessment by wearers of device 2

Putting on and taking off:	second person required
Accessibility of all control systems:	no complaint
Weight distribution:	no complaint
Safety of connecting pieces and connections:	no complaint
Resistance to fogging of the sight window:	no complaint
Visual distortion through the sight window:	no complaint
Field of vision:	no complaint
Recognition of characters (150 mm at 6 m)	legible
Understanding with a supervisor:	no complaint
Distribution of the weight of the worn device:	no complaint
Accidental switching on and off:	no complaint
Influence of the air output volume:	no complaint
Fitness of the alert system:	adequate alert signal
Freedom of movement of the head:	no complaint
Comfortable for the wearer:	no complaint
Additional information:	none

23.3 Assessment by wearers of device 3

Putting on and taking off:	second person required
Accessibility of all control systems:	no complaint
Weight distribution:	no complaint
Safety of connecting pieces and connections:	no complaint
Resistance to fogging of the sight window:	no complaint

Visual distortion through the sight window:	no complaint
Field of vision:	no complaint
Recognition of characters (150 mm at 6 m)	legible
Understanding with a supervisor:	no complaint
Distribution of the weight of the worn device:	no complaint
Accidental switching on and off:	no complaint
Influence of the air output volume:	no complaint
Fitness of the alert system:	adequate alert signal
Freedom of movement of the head:	no complaint
Comfortable for the wearer:	no complaint
Additional information:	none

24. Carbon dioxide in the inspired air**24.1 Requirement**

The carbon dioxide content of the inspired air (dead space) measured when the blower is running shall not exceed a concentration of 1.0 by volume.

Tests shall be performed with the minimum setting of the rated output volume, i.e. 400 l/min.

24.2 Test performance

The Mururoa Blu PVC safety suit was worn in the same way as by the wearer and placed on a suitable test unit and the CO₂ concentration in the inspired air was determined.

24.3 Test results

Test	Concentration % by vol.
1	0.58

The requirement was met.

25. Field of vision through the helmet**25.1 Requirement**

Main field of vision: ≥ 70 %
Secondary field of vision: ≥ 80 %

25.2 Test results

Main field of vision	Secondary field of vision
100	100

The requirement was met.

26. Mass of the respiratory protection device

Fan	0.96 kg
Accumulator	1.41 kg
4 filters	0.56 kg
Protective suit	2.00 kg
Total mass (5 kg max)	4.93 kg
Mass carried on the head (1.5 kg max)	irrelevant

The requirements were met.

The test results provided in this document refer to the tested objects.
No inference about the homogeneity of the production may be made.

Berufsgenossenschaftliches Institut
für Arbeitsschutz – BIA –

pp

Christoph Thelen, engineer

Manager

Werner Piontkowski

3 Test**3.1 Type of test** Construction type test**3.2 Date of test** February to May 2004**3.3 Test methods and bases** EN 1073-1: 1998 and EN 12941: 1998**4 Appreciation, fitness
for use**

Fan-assisted ventilated contamination protection garments Mururoa Blu Ethyfuge and Mururoa Blu PVC fitted out as described in point 2.2 meet the requirements for device class TH3 PSL.

Further, fan-assisted contamination protection garments Mururoa Blu Ethyfuge and Mururoa Blu PVC fitted out as described in point 2.2 meet the requirements provided under 4.4.2, 4.5, 4.6, 4.8, 4.11, 4.12, 4.13 and 4.14, and flame resistance to 4.2 under EN 1073-1: 1998 and also meet the requirements under 4.3 relating to the class 4 protection factor rating.

Miscellaneous information

Points 8 (identification) and 9 (instructions for use) under EN 12941: 1998 were not tested. This test report only applies to the fan-assisted contamination protection garment fitted out as described in point 2.2 that is designed to be used with four filters.

Compliance with point 5 of the protocol enclosed is required.

5 Validity of the test report

The results found are only applicable to the tested objects.

Restrictions on the validity and use of this test report:

6 General information

This test report comprises **12** pages.

Pages 1 to 3 contain the overall test result and may only be published in full.

NO/848 196 T UK

INDICE : a

DATE : 10-04

PAGE 1/4

MURUROA BLU PVC
INSTRUCTIONS FOR USE
EPI 848 196 T

DELTA PROTECTION

☎ 04 66 89 18 36

DELTA PROTECTION
Z.A du Berret
30200 BAGNOLS-SUR-CEZE - FRANCE
☎ (33) 04 66 89 18 36
☒ (33) 04 66 89 36 31

**VENTILATED PROTECTIVE CLOTHING FOR ONE-TIME USE, "BLOWER SUPPORTED" TYPE
(VENTILATED AND INTERNALLY PRESSURIZED) AGAINST PARTICULATE RADIOACTIVE
CONTAMINATION; ACCORDING TO STANDARD EN 1073-1 (March 1998)**

The instructions for use have to be read and respected.

- Warning:**
- The selection and use of an individual protective suit must conform to the European guidelines EEC 89/656 of 30/11/1989.
 - The user must first examine and evaluate the risks associated with the adoption and use of the individual protective suit selected.
 - For this procedure, he will find guidance in the "Guide pour la sélection et l'utilisation des appareils de protection respiratoire" (guidelines for the selection and use of breathing protection devices), published by AFNOR, no. S76-005 CR 529. Investigation by the user must also consider the hindrance to rapid doffing of the equipment in an emergency, as well as the radiological consequences (radiation) to the person affected.

- Introduction:**
- This suit was developed for one-time use for protection against particulate radioactive hazards in accordance with standard EN 1073-1 and its use can be extended to cover protection against particles of all kinds.
 - This (protective) clothing must be used only under supervision by the group leader in charge, who must first verify specifically that:
 - This suit provides protection corresponding to the categories of hazard faced.
 - The blowing unit of the ventilated suit is operating properly.
 - The particle filters used (type PF 10 ref. 0312103 or type DP P3 ref. 17 86 000) afford the necessary protection against the hazardous substances encountered during use.
 - All use of the suit takes place under supervision (either by physical presence or by video link) and all life-saving equipment is ready and available in case of emergency during the operation.

DESCRIPTION

The Mururoa BLU protective suit is used with a B60 blowing unit, delivering 400 or 600 l/minute (according to choice) and P3PF10 or DPP3 filters. The suit protects the wearer (whole body) against harmful solid particles, splashes and soiling.

The equipment comprises a Mururoa BLU protective suit, a blowing unit, a battery, a charging device and 4 P3PF10 or DP P3 filters.

Selecting delivery of 400 l/min or 600 l/min: remove the rubber closure cap on the blowing unit unit to obtain access to the setting plugs. Move the lower red plug to the left to set the fan to 400 l/min and to the right to set it to 600 l/min position. NB: do not touch the top plug. Then fix the rubber closure cap back over the opening.



LIMITATIONS TO USE

- The filter apparatus must not be used in an unknown environment. In case of any doubt, isolating protective devices must be used, irrespective of the atmosphere present.
- Only filters of type PF 10 (ref. 03 12 103) or type DP P3 (ref. 17 86 000) may be used.
- The filtering apparatus should not be used in confined spaces (e.g. tunnels, tanks) or in conditions of lack of oxygen or presence of heavy gases (e.g. carbon dioxide).
- The filtering apparatus may only be used once if the air contains more than 18% oxygen by volume.
- The particle filters do not give protection against gases or vapours.
- The particle filters may only be used once against radioactive substances, micro-organisms (viruses, bacteria, moulds) or enzymes.
- Operating conditions: +5°C - +35°C, relative humidity less than 75%.

NO/848 196 T UK

INDICE : a

DATE : 10-04

PAGE 3/4

MURUROA BLU PVC
INSTRUCTIONS FOR USE
 EPI 848 196 T



☎ 04 66 89 18 36

STORAGE

In original packaging, protected from light, at temperatures between +5°C and +45° C. Shelf life three years in original packaging.

EMERGENCY DEVICE

Tearing off the safety strip on the front of the helmet enables the wearer to breathe the outside air.
 If the wearer (of the protective suit) tears off the doffing strip, the upper part of his body can be disengaged from the garment within 5 seconds.

BLOWING UNIT ALARM DEVICE

- The blowing unit that supplies the protective suit is provided with two audible warning devices which are triggered as follows:
 - o Low throughflow (e.g. filter blocked by a foreign body), intermittent signal -----
 - o Weak battery (discharged battery), continuous signal _____ for several minutes.

Warning: Immediately after the end of the weak battery alarm (up to 15 minutes, depending on equipment) the system goes into safety mode and switches off the blowing unit automatically.
 It is therefore vital to stop work as soon as the alarm sounds, as the potential danger is great.

If the blowing unit alarm sounds during operations:

- Leave the contaminated area immediately.
- Find the cause of the alarm (weak battery, blocked filter)
- Clear the problem before returning to the contaminated zone.

ERGONOMICS

The materials employed as combined and presented are not hazardous or in any particular respect noxious (e.g. irritant to the skin) for the wearer.

REMARKS

Disposable protective clothing

TECHNICAL CHARACTERISTICS OF THE MATERIALS

Type of test	Reference standard	Performance grade
Results for whole suit Bending strength Abrasion strength Perforation strength Tear strength Flame resistance Strength of welded seams*	EN 1073-1	Inapplicable, as one-time use Class 6 (> 2000 cycles NF EN 530) Class 1 (> 10N NF EN 863) Class 3 (> 20N NF EN ISO 9073-4) Requirements met (EN 1146) Class 4 (> 125N ISO 5082)*
Results with respect to whole suit**	EN 1073-1	Protective clothing Class 4. Designates the nominal protection factor of the suit (Class 4: nominal protection factor of 20 000)

*: Mechanical strength (to ISO 5082) of the doffing strip or safety strip also corresponds to Class 4.

** : The protection factor results were obtained in the laboratory, and may vary more or less under actual working conditions.

KEY

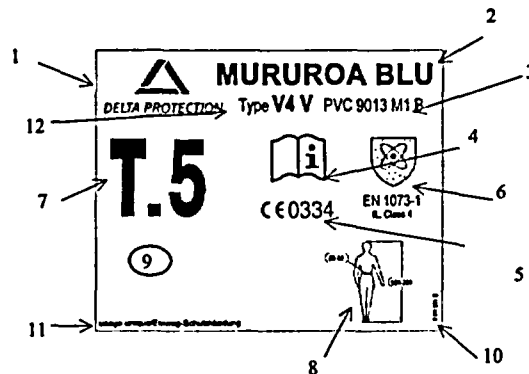

NO/848 196 T UK

INDICE : a

DATE : 10-04

PAGE 4/4

MURUROA BLU PVC
INSTRUCTIONS FOR USE
EPI 848 196 T

DELTA PROTECTION

☎ 04 66 89 18 36

Position:

The labels are located on both outlet valves on the helmet and the back of the suit.

1. Manufacturer
2. Model name

Main material of the garment, and its fire resistance according NFP 92 507 : M1
NFG 07 184 : B

3. "Open book" pictogram: Indication that the instructions for use should be read
4. EC mark. The garment conforms to standards relating to manufacture monitoring, type 11b in accordance with guidelines 89/686/EWG. 0334 is the identification number of the organization responsible for production control.

5. 

EN 1073-1: Requirements and test methods for ventilated protective clothing against particulate radioactive contamination. IL: Class 4 defines the nominal protection factor of the clothing (Class 4 nominal protection factor 20,000).

6. Garment size
7. Measurements of the different sizes.
8. Position for: date of manufacture, goods batch number and expiry date.
9. Number and reference of label checking
10. Certification of one-time use clothing to standard EN 1073-1
11. Internally ventilated type of protective clothing: type V4 V.

Garment EC certified by:
BIA

Berufsgenossenschaftliches Institut für Arbeitsschutz
Alte Heerstraße 111
53754 Sankt Augustin - ALLEMAGNE
Telephone: +49 22 41 2 31-02 - Fax: +49 22 41 2 31 22 34

**MURUROA BLU ETHYFUGE
INSTRUCTIONS FOR USE**
EPI 848 496 T

DELTA PROTECTION

☎ 04 66 89 18 36

DELTA PROTECTION
Z.A du Berret
30200 BAGNOLS-SUR-CEZE - FRANCE
☎ (33) 04 66 89 18 36
☒ (33) 04 66 89 36 31

**VENTILATED PROTECTIVE CLOTHING FOR ONE-TIME USE, "BLOWER SUPPORTED" TYPE
(VENTILATED AND INTERNALLY PRESSURIZED) AGAINST PARTICULATE RADIOACTIVE
CONTAMINATION; ACCORDING TO STANDARD EN 1073-1 (March 1998)**

The instructions for use have to be read and respected.

- Warning:**
- The selection and use of an individual protective suit must conform to the European guidelines EEC 89/656 of 30/11/1989.
 - The user must first examine and evaluate the risks associated with the adoption and use of the individual protective suit selected.
 - For this procedure, he will find guidance in the "Guide pour la sélection et l'utilisation des appareils de protection respiratoire" (guidelines for the selection and use of breathing protection devices), published by AFNOR, no. S76-005 CR 529. Investigation by the user must also consider the hindrance to rapid doffing of the equipment in an emergency, as well as the radiological consequences (radiation) to the person affected.

- Introduction:**
- This suit was developed for one-time use for protection against particulate radioactive hazards in accordance with standard EN 1073-1 and its use can be extended to cover protection against particles of all kinds.
 - This (protective) clothing must be used only under supervision by the group leader in charge, who must first verify specifically that:
 - This suit provides protection corresponding to the categories of hazard faced.
 - The blowing unit of the ventilated suit is operating properly.
 - The particle filters used (type PF 10 ref. 0312103 or type DP P3 ref. 17 86 000) afford the necessary protection against the hazardous substances encountered during use.
 - All use of the suit takes place under supervision (either by physical presence or by video link) and all life-saving equipment is ready and available in case of emergency during the operation.

DESCRIPTION

The Mururoa BLU protective suit is used with a B60 blowing unit, delivering 400 or 600 l/minute (according to choice) and P3PF10 or DPP3 filters. The suit protects the wearer (whole body) against harmful solid particles, splashes and soiling.

The equipment comprises a Mururoa BLU protective suit, a blowing unit, a battery, a charging device and 4 P3PF10 or DP P3 filters.

Selecting delivery of 400 l/min or 600 l/min: remove the rubber closure cap on the blowing unit unit to obtain access to the setting plugs. Move the lower red plug to the left to set the fan to 400 l/min and to the right to set it to 600 l/min position. NB: do not touch the top plug. Then fix the rubber closure cap back over the opening.



LIMITATIONS TO USE

- The filter apparatus must not be used in an unknown environment. In case of any doubt, isolating protective devices must be used, irrespective of the atmosphere present.
- Only filters of type PF 10 (ref. 03 12 103) or type DP P3 (ref. 17 86 000) may be used.
- The filtering apparatus should not be used in confined spaces (e.g. tunnels, tanks) or in conditions of lack of oxygen or presence of heavy gases (e.g. carbon dioxide).
- The filtering apparatus may only be used once if the air contains more than 18% oxygen by volume.
- The particle filters do not give protection against gases or vapours.
- The particle filters may only be used once against radioactive substances, micro-organisms (viruses, bacteria, moulds) or enzymes.
- Operating conditions: +5°C - +35°C, relative humidity less than 75%.

NO/848 496 T UK

INDICE : a

DATE : 10-04

PAGE 2/4

MURUROA BLU ETHYFUGE
INSTRUCTIONS FOR USE
EPI 848 496 T

DELTA PROTECTION

☎ 04 66 89 18 36

This protective clothing must be used with the blowing unit running. If the fan breaks down, the equipment no longer provides breathing protection and excessive levels of carbon dioxide may build up. (Danger of suffocation!).

Before use, it is essential to check:

- the condition and integrity of the protective suit and the breathing pipe.
- the condition and integrity of the blowing unit and its battery (no chock or failure).
- the condition and integrity of the P3 filter.

BATTERY

The technology of the battery (NiMh) demands that it should be fully charged before use and between times. The battery must therefore be removed and recharged each time it has been used. Nominal total recharging time is 8 hours.

CHARGING THE BATTERY

Charge the battery before use. Battery temperature before charging must be between +10°C and +30°C. Always use the charger developed for use with the B60 blowing unit (the charger is supplied with the blowing unit). The battery must be charged in a dry place at room temperature, away from direct sunlight and dust. Remove the battery block from the blowing unit by means of the release device. Push the charging plug fully into the charger adapter.

Connect the battery charger to the electricity mains (110-240 V/50-60 Hz)

Battery charger warning light displays: _____ Charging
_____ Maintaining charge

Ⓛ A battery cannot be used until the warning lights show " Maintaining charge ".

DONNING THE SUIT

- The wearer (of the protective clothing), aided by a dresser, conducts a visual inspection of the condition of the (protective) clothing and its components, removes the transport protection (cardboard on the visor and inside the clothing) and the protective film on the visor.
- He then lays the suit out flat and fits the blowing unit as follows:
 - Insert the blowing unit in the pocket provided for the purpose
 - Connect the pipe of the suit to the output of the blowing unit
 - Screw in the 4 filter cartridges and check that they are firmly seated against the blowing unit (for a hermetic seal).

Note: Fit the blowing unit with its fully charged battery (the battery clips into position under the blowing unit).

Fitting:

- Push back the two lateral stainless steel closures
- Fit the battery under the bottom of the blowing unit, pushing in the plug
- Pull the closures up and push them back towards the middle of the battery to secure the fastening on both sides.

Removal

- Pull the closures first outwards and then downwards to release the battery.

- He switches on the blowing unit and gets into the lower part of the suit through the opening at the back.
- His dresser then closes the two zip fasteners (sliding fastener + zip fastener) and ensures a hermetic seal by applying adhesive tape over the whole length of the opening. He ties the laces of the overboots round the ankle.
- The wearer makes sure that the air supply, blowing unit and excess pressure valves are working properly by bending down sharply several times.
- He can then enter the area of operations.

DOFFING THE SUIT

- The suit can be removed using the strip provided for the purpose. For this, the suit must still be ventilated. The dresser pulls the blue strip that runs from wrist to wrist over the top of the helmet and rolls both the front and back parts so that the contamination is inside and cannot come into contact with the wearer.
- It must be possible to remove the helmet quickly in case of need. Also pay attention to any other devices that could hinder removal of the suit (external safety harness, adhesive tape, etc.).

IMPORTANT

- Should the suit begin to lose air, if condensation begins to appear on the visor or the wearer feels unusual warmth, he should leave the area of operations immediately.
- Remember that the suit remains pressurized for a little while, even after the air supply is interrupted.

MURUROA BLU ETHYFUGE

INSTRUCTIONS FOR USE

EPI 848 496 T



DELTA PROTECTION

☎ 04 66 89 18 36

STORAGE

In original packaging, protected from light, at temperatures between +5°C and +45° C. Shelf life three years in original packaging.

EMERGENCY DEVICE

Tearing off the safety strip on the front of the helmet enables the wearer to breathe the outside air.
If the wearer (of the protective suit) tears off the doffing strip, the upper part of his body can be disengaged from the garment within 5 seconds.

BLOWING UNIT ALARM DEVICE

- The blowing unit that supplies the protective suit is provided with two audible warning devices which are triggered as follows:
 - o Low throughflow (e.g. filter blocked by a foreign body), intermittent signal -----
 - o Weak battery (discharged battery), continuous signal _____ for several minutes.

Warning: Immediately after the end of the weak battery alarm (up to 15 minutes, depending on equipment) the system goes into safety mode and switches off the blowing unit automatically.

It is therefore vital to stop work as soon as the alarm sounds, as the potential danger is great.

If the blowing unit alarm sounds during operations:

- Leave the contaminated area immediately.
- Find the cause of the alarm (weak battery, blocked filter)
- Clear the problem before returning to the contaminated zone.

ERGONOMICS

The materials employed as combined and presented are not hazardous or in any particular respect noxious (e.g. irritant to the skin) for the wearer.

REMARKS

Disposable protective clothing

TECHNICAL CHARACTERISTICS OF THE MATERIALS

Type of test	Reference standard	Performance grade
Results for whole suit Bending strength Abrasion strength Perforation strength Tear strength Flame resistance Strength of welded seams*	EN 1073-1	Inapplicable, as one-time use Class 6 (> 2000 cycles NF EN 530) Class 1 (> 10N NF EN 863) Class 3 (> 20N NF EN ISO 9073-4) Requirements met (EN 1146) Class 3 (> 75N ISO 5082)*
Results with respect to whole suit**	EN 1073-1	Protective clothing Class 4. Designates the nominal protection factor of the suit (Class 4: nominal protection factor of 20 000)

*: Mechanical strength (to ISO 5082) of the doffing strip or safety strip also corresponds to Class 3.

** : The protection factor results were obtained in the laboratory, and may vary more or less under actual working conditions.

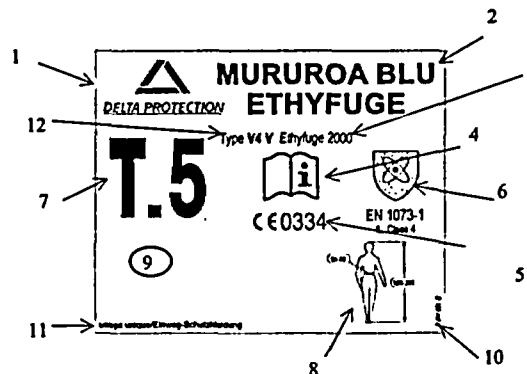
KEY

NO/848 496 T UK

INDICE : a

DATE : 10-04

PAGE 4/4

MURUROA BLU ETHYFUGE
INSTRUCTIONS FOR USE
EPI 848 496 T

DELTA PROTECTION

☎ 04 66 89 18 36

Position:

The labels are located on both outlet valves on the helmet and the back of the suit.

1. Manufacturer
2. Model name
3. Main material of the garment
4. "Open book" pictogram: indication that the instructions for use should be read
5. EC mark. The garment conforms to standards relating to manufacture monitoring, type 11b in accordance with guidelines 89/686/EEG. 0334 is the identification number of the organization responsible for production control.



6. EN 1073-1: Requirements and test methods for ventilated protective clothing against particulate radioactive contamination. IL: Class 4 defines the nominal protection factor of the clothing (Class 4 nominal protection factor 20,000).
7. Garment size
8. Measurements of the different sizes.
9. Position for: date of manufacture, goods batch number and expiry date.
10. Number and reference of label checking
11. Certification of one-time use clothing to standard EN 1073-1
12. Internally ventilated type of protective clothing: type V4 V.

Garment EC certified by:

BIA

Berufsgenossenschaftliches Institut für Arbeitsschutz
Alte Heerstraße 111
53754 Sankt Augustin - ALLEMAGNE
Telephone: +49 22 41 2 31-02 - Fax: +49 22 41 2 31 22 34

INSTRUCTION MANUAL BLOWING UNIT BLU C500

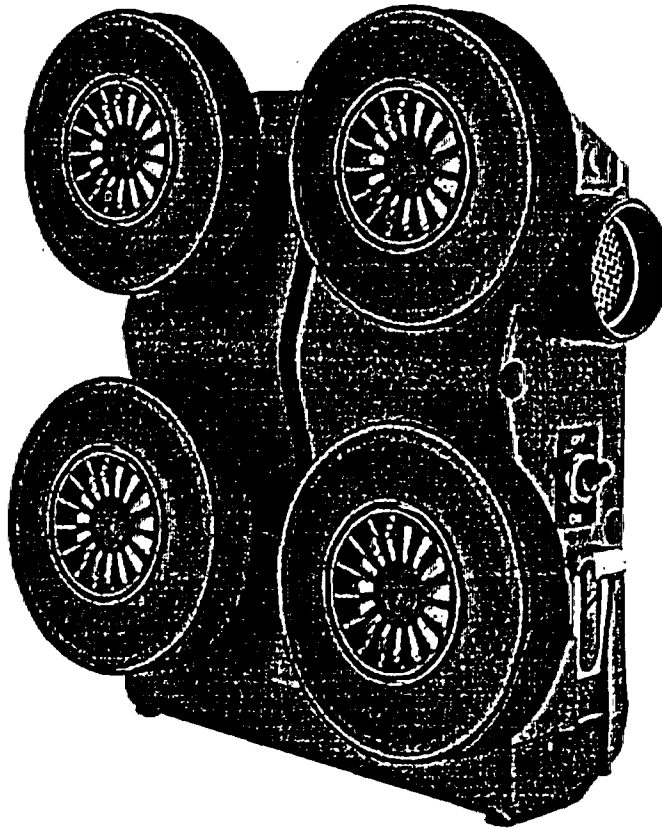

Compact Air Supply Unit (CASU)

Part No:	C500X-012EK-A B30	300/200 l/min
Part No:	C500X-012EK-A B60	600/400 l/min

Class: EN12941: 1998 TH3 PSL

To be used with:

Battery Module	C501A-012AK-A
Intercon Cable	C502L-012XX-A
Cigarette Lighter Cable	C503L-012XX-A
Power Supply	C504L-230XX-A

Charger	C510L-230XX-A
Flow Control	C401X-500A9

Index

Chapter / Title	Page
1 Important Instruction	3
1.1 Application Field	3
1.2 Description and Operating Mode (see also 7.1 Explosive Drawing)	3
1.3 Insufficient Air Flow	3
1.4 Total discharge of Battery	3
1.5 Preparation of the Blowing Unit BLU	3
1.6 Filter	4
2 Putting into operation of the Blower Unit BLU	4
2.1 Operation directly from the battery module I	4
2.2 Battery function via interconnection cable	4
2.3 External power with cigarette lighter connector 12VDC	5
2.4 External power with power supply 90 -264VAC	5
2.5 External power with cigarette lighter connector cable 12VDC (without battery)	6
2.6 External power with power supply 90-264VAC (without battery)	6
2.7 Functioning control	6
2.7.1 BLU functions correctly	7
2.7.2 Defective alarm signal	7
2.7.3 Defective housing	7
2.7.4 Battery charging	7
2.7.5 Airflow control	7
3 Operation of the Blowing unit BLU with Protective Suit	7
3.1 Fixation of air hose	7
3.2 Fixation of the Blowing unit to the Protective Suit	7
4 Battery Charging	8
4.1 Charger unit for 90-264VAC	8
4.2 Charging condition of battery module	8
5 Maintenance	8
5.1 Cleaning	8
5.2 Sterilisation (for medical applications)	8
5.3 Maintenance and inspection	8
5.4 Technical service	8
6 Malfunction	8
7 Replacement Parts	9
7.1 Blowing unit drawing	9
7.2 Part Description Part Number	9
8 Storage	9
9 Waste Management	9
10 Technical Data	10
11 Warranty and Liability	10

1 Important Instruction

- **Caution:** Carefully read this instruction and implement necessary steps as indicated before initial use.

1.1 Application Field

- The Blowing Unit BLU with corresponding modules can be used in connection with an overall protective suit for various applications.
- Particular standards and technical regulations have to be considered.

1.2 Description and Operating Mode (see also 7.1 Explosive Drawing)

- The blowing unit BLU consists of 4 filter threads Rd40 and the blower with electronics control.
- The unit is equipped with an Rd52-thread for the air hose.
- With the lever switch the BLU can be set ON and OFF.
- The air flow is pre-adjusted and marked by the colour of the service cover (see 1.5)
- The battery housing contains the rechargeable NiMH batteries. The 4-pole-plug can be fixed to both the blower housing and the battery for charging.

1.3 Insufficient Air Flow

- If the fan does not perform the required airflow the unit starts an intermittent warning signal "Low Flow" (interval approx. 0.5 seconds). From the start of the warning signal there is a remaining security running time of approx. 15 min at 20 °C.

1.4 Total discharge of Battery

- Battery end is signalled by a continuous warning signal "Low Battery". From the start of the warning signal there is a remaining security running time of approx. 15 min at 20 °C.
- **Caution:** Afterwards the BLU has to be switched off in order to avoid possible damage of the battery (total discharge of the battery)

1.5 Preparation of the Blowing Unit BLU

- Visual control in view of damages
- Are the 4 filters sealing placed correctly?
- Check pre adjusted air flow by mean of service cover colour:

C500X-012EK-A		
B60 :BLACK	600	400 lpm
B30 :RED	300	200 lpm

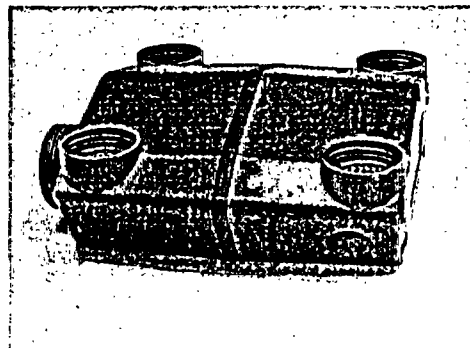

picture 1

1.6 Filter

- Put the blowing unit into operation only with correctly screwed filters.
- Only use the specified DP PF10 or DP P3 filters.
- **Caution:** The unit performs the pre-adjusted airflow only with the specified filters. Non observing may result in danger of life.
- Screw the filters in order that all sealings are pressed and the filter connections tight.
- Only use 4 filters of same type (changed same time).

2 Putting into operation of the Blower Unit BLU

- Various power connection/source possibilities:
 - Standard battery (chapter 2.1)
 - Battery via interconnection cable (chapter 2.2)
 - External power supply 12 VDC (chapter 2.3 and chapter 2.5)
 - External power supply 90-264 VAC (chapter 2.4 and chapter 2.6)
- Notice also chapter 1 2 "Operating Mode"

2.1 Operation directly from the battery module I

- Attach the battery module to the BLU unit (see picture 2)
- **Caution:** Only use fully charged batteries (see chapter 4 "Battery Loading")

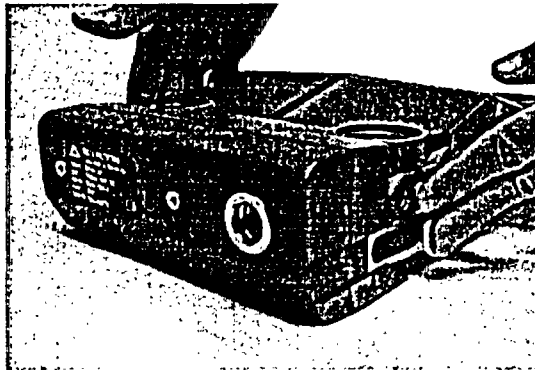

picture 2

2.2 Battery function via interconnection cable

- Connect the battery module to the cable according to picture 3.
- **Caution:** Only use fully charged batteries (see chapter 4 "Battery Loading")

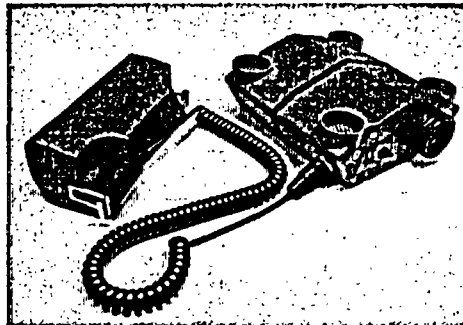

picture 3

- The battery module has to be attached separately.
- Unlocking device according to picture 4

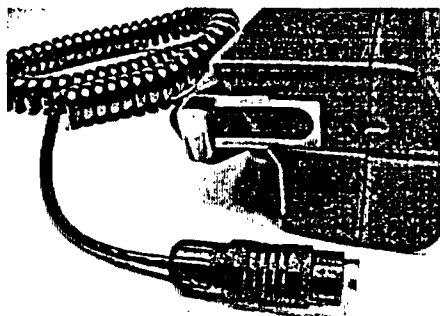

picture 4

2.3 External power with cigarette lighter connector 12VDC

- This cable can be directly connected to the battery module. The cigarette connector fits into an ordinary car cigarette lighter plug. .
- **Caution:** The Blowing unit BLU cannot be set on when connecting both, interconnection cable and external power.

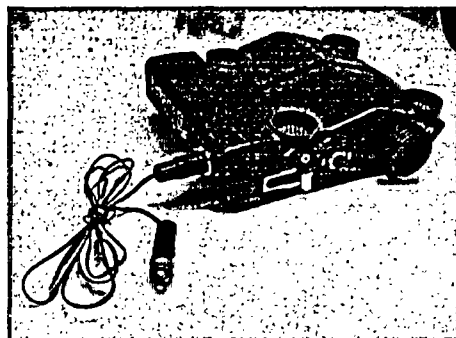

picture 5

2.4 External power with power supply 90 -264VAC

- The power supply can be directly connected to the battery module.
- **Caution:** The Blowing unit BLU cannot be set on when connecting both, interconnection cable and external power.

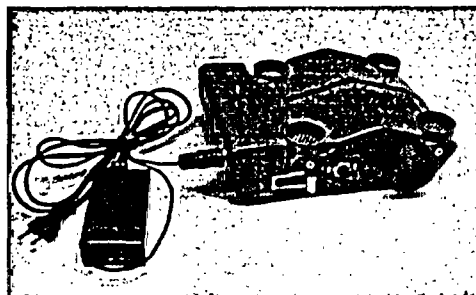

picture 6

2.5 External power with cigarette lighter connector cable 12VDC (without battery)

- This cable can be directly connected to the Blowing unit BLU. The cigarette connector fits into an ordinary car cigarette lighter plug.
- **Caution: No warning signal in case of power cut.**

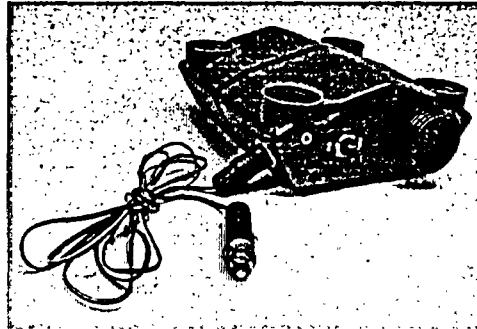

picture 7

2.6 External power with power supply 90-264VAC (without battery)

- The power supply can be directly connected to the Blowing unit BLU
- **Caution: No warning signal in case of power cut.**
-

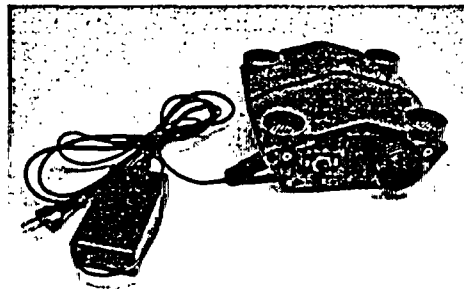

picture 8

2.7 Functioning control

- Switch the Blowing unit BLU on according to picture 9. Close the air exhaust (Rd52) of the Blowing unit (for example with your hand)

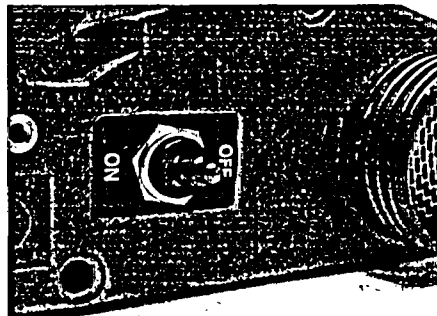

picture 9

2.7.1 BLU functions correctly

When the blower rotations are increasing (louder sound) together with alarm signal "Low Flow" (0,5 seconds interval).
In case the airflow falls below nominal value an intermitting alarm signal starts (0,5 seconds interval).

2.7.2 Defective alarm signal

Increasing rotations and no alarm signal. .
Caution: Do no longer use the Blowing unit BLU. The BLU needs to be serviced.

2.7.3 Defective housing

Increasing blower rotations together with alarm signal.
Caution: Do no longer use the Blowing unit BLU. The BLU needs to be serviced

2.7.4 Battery charging

Constant alarm signal (continuous tone) means low battery.
Caution: Do no longer use the Blowing unit BLU. Exchange the battery module for a fully charged battery module.

2.7.5 Airflow control (option)

The airflow control measures the airflow.
- Hold the measuring instrument within a distance of 5 cm from the outlet adapter and read the airflow on the indication.
- Important: do not hold the Blowing unit BLU against a bright light source in order to avoid failure function.

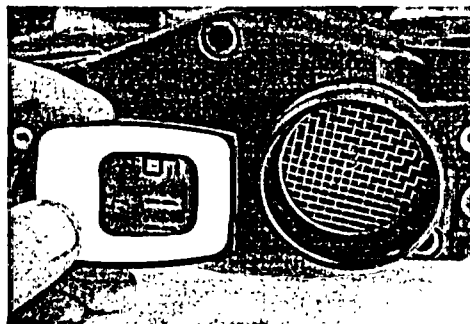

picture 10

3 Operation of the Blowing unit BLU with Protective Suit or protective hood.

3.1 Fixation of air hose

- Screw the air hose by mean of the Rd52-nut to the BLU and possibly also to the protective suit or protective hood. Screw tightly until the sealing is pressed and the hose connection is leak proof.

3.2 Fixation of the Blowing unit to the Protective Suit

- Functioning control as described under 2.7
- Read and respect the protective suit instructions for use.

4 Battery Charging

4.1 Charger unit for 90-264VAC

- Connect the battery module with the cable to the charger unit
- Indication lamp red shines constantly: the module is in charging condition and **may not be used.**
- Indication lamp red flashes slowly: the module is fully charged and ready for use. .
- Indication lamp red flashes quickly: too high or too low temperature. The charger unit **may not be used** and first has to be brought to normal/correct temperature.

4.2 Charging condition of battery module

- In order to have always charged battery modules available, connect the module to the charger after every use.
- Before the first use, charge/discharge roughly 5 times the battery to have the full capacity.
- See also chapter 2.7.4.

5 Maintenance

5.1 Cleaning

- Ordinary cleaning with soapy water and only with openings and air exhaust closed.
- **Caution:** Showering only with shower cap and the blowing unit running.

5.2 Sterilisation (for medical applications)

- See special instructions.

5.3 Maintenance and inspection

- The Blowing unit does not need maintenance for approx. 1000 hours.
- After this period of use all adjustments have to be checked by the technical servicing department.

5.4 Technical service

- **Execution of all kind of service work only by authorized qualified staff.**

6 Malfunction

- The blowing unit does not start: no Battery or empty battery
- Alarm signal: see chapter 2.7
- Running time is not reached. Battery insufficiently charged or defective.

7 Replacement Parts

7.1 Blowing unit drawing

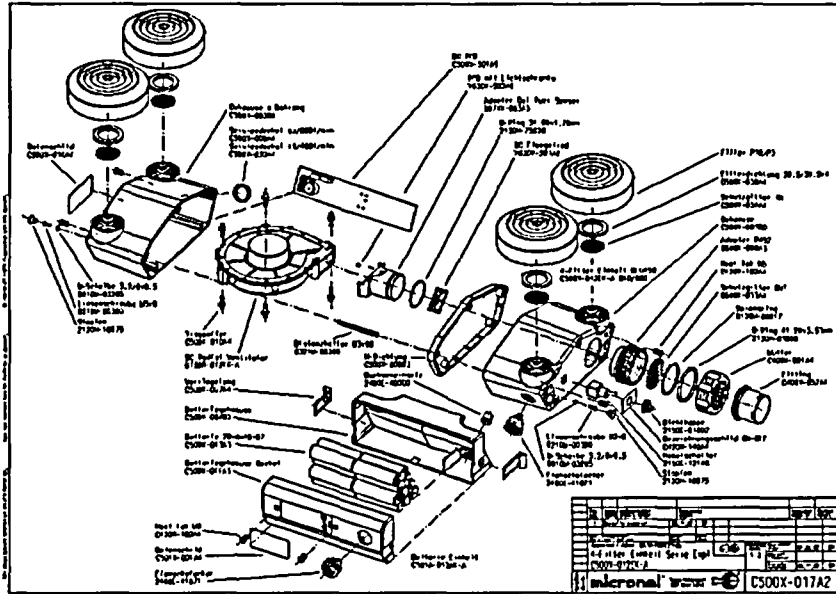

7.2 Part Description	Part Number
- Blower Unit	C500X-012EK-A B60 oder B30
- Battery Module	C501A-012AK-A
- Intercon Cable	C502L-012XX-A
- Cigarette Lighter Cable	C503L-012XX-A
- Power Supply	C504L-230XX-A
- Charger Unit	C510L-230XX-A
- Filters	XXXXXXXXXX
- Service Cover red	C500X-030B4
- Service Cover black	C500X-009B4
- Filter Sealing	C420X-011A4

8 Storage

- Storage of the blowing unit within the packing at room temperature of - 10 / + 60 °C.
- Charging of battery at least once a year.
- After use store the blowing unit in proper condition (cleaned).

9 Waste Management

- Disposal of the Units according to local/national regulations for waste disposal. Plastic parts weighing more than 10 gr are marked with the material identification.

10 Technical Data

Part	Description	Capacity	
BLOWING UNIT C500x-012EK-AB60	Service cover black	600 Pa – 600 l/min	
	Running time with fully charged battery	minimum 4 h	
	Service cover red	280 Pa – 400 l/min	
	Running time with fully charged battery	minimum 7 h	
BLOWING UNIT C500x-012EK-AB30	Service cover black	420 Pa – 300 l/min	
	Running time with fully charged battery	minimum 11 h	
	Service cover red	200 Pa – 200 l/min	
	Running time with fully charged battery	minimum 18 h	
BLOWING UNIT C500x-012EK-ABXX	Measuring at air density of	1,2 kg/m ³	
	Blower	Electronically controlled radial fan	
	Sensor	Optical airflow sensor	
	Warning signal	Whistle (continuous sound)	15 min. before battery end
		Beep (0,5s interval)	not enough airflow (Low flow) see 1.3
	Material/Colour	NORYL GFN1-211 / blue	
	Weight	1000 gr without filters	
	Dimensions (without filters)	192 x 190 x 76 mm	
	Application range	+ 10 / + 50 °C	
FILTERS	Filter class	P3	
	Filter Type(thread Rd40x1/7")	DP PF 10 DP P3	
	Weight	90 gr/filter 130 gr / filter	
	Shower Cap	EPDM black	
	Battery		
Battery	Nominal voltage	12 VDC	
	Capacity	9 Ah	
	Type (rechargeable)	NIMH	
	Regular charging time	7 h	
	Number of charging cycles	500	
	Material/Colour	NORYL GFN1-211 / bleu	
	Weight	1440 gr	
	Dimensions d x h	88 x 190 x 70 mm	
	Application range	+ 10 / + 50 °C	
Charger	Type	C510L-230XX-A	
	Entrance voltage range	90 – 264 V / 50/60 Hz	
	Exhaust voltage	12 VDC	
	Charger plug	4 pôles	
	Material / Colour	PPE-V1 125°C, noir	
	Dimensions d x h	105 x 68 x 39 mm	
External power supply	External battery	12 VDC spiral cable 2,5 m stretched	
	With cigarette lighter plug	12 VDC spiral cable 2,5 m stretched	
	With power supply	230 VAC spiral cable 2,5 m stretched	

11 Warranty and Liability

Our warranty period will be in accordance upon in each case from the date of delivery. The warranty covers any defects in material or workmanship. It is our decision whether the defective part or parts will be replaced, repaired or the invoice value of the non replaced part or parts be reimbursed.; and further liability, in particular, subsequent damages, are excluded. We do not accept any liability for alterations or repairs of any kind, not performed by us or a specialist recommended by us, in addition the warranty will expire in such a case.

PRO2000 FILTERS

FOR RESPIRATORY
PROTECTIVE EQUIPMENT

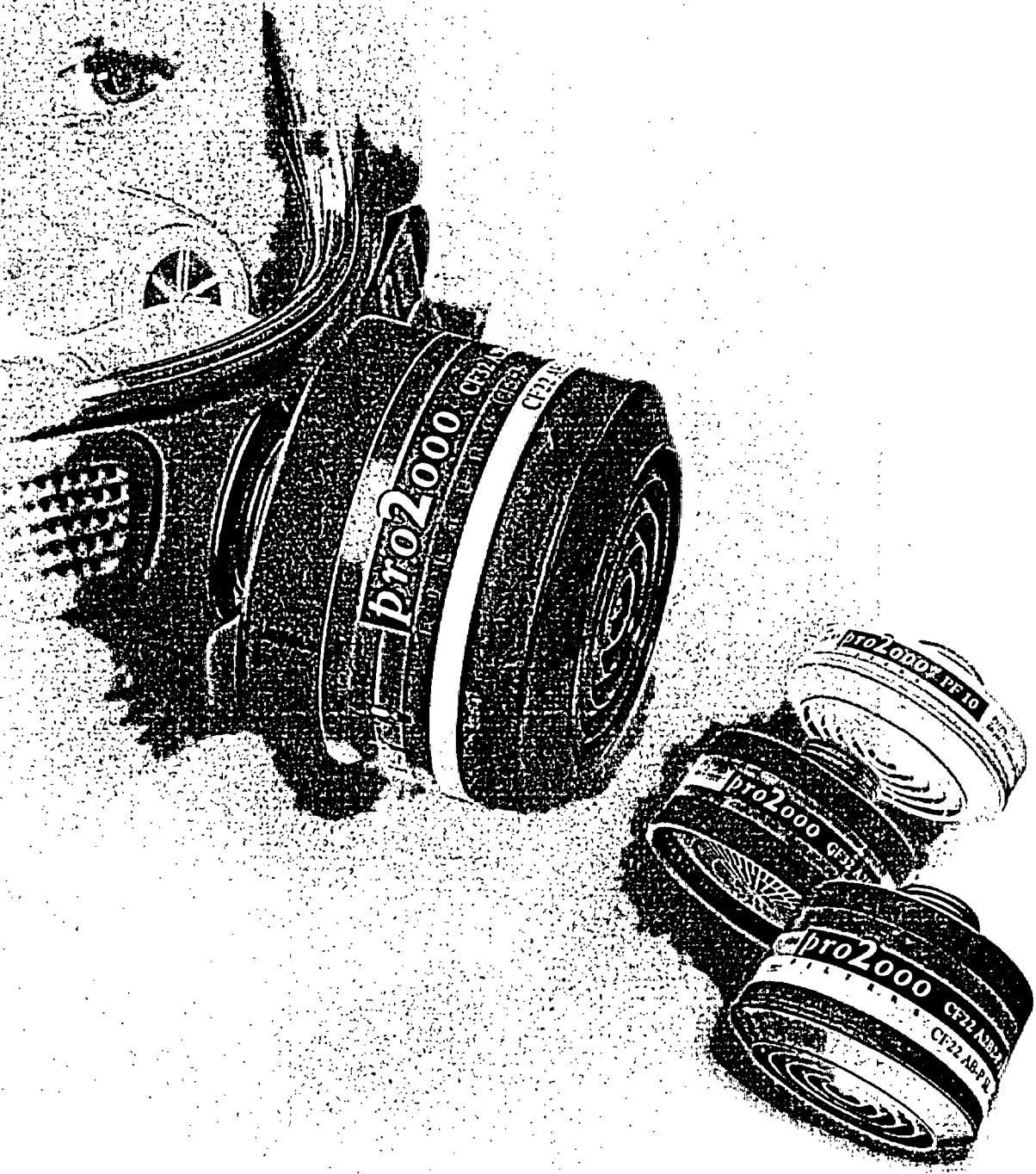

SCOTT

PRO2000

FILTER RANGE

The Pro2000 filter range embraces the entire selection of respiratory filters, all of which conform to EN standards and carry the CE mark. Pro2000 filters are particularly suitable for use with the Scott's full face masks and powered respirators. The Pro2000 filter connector meets the EN 148-1 standard, 40 mm thread.

PRO2000 FILTERS

- Particle filters trap wide range of particulate impurities, e.g. solid particles, smoke, welding fumes, aerosols, mists, micro-organisms (bacteria and viruses) plus radioactive particles.
- Gas filters protect against hazardous gases and vapours.
- Combined filters protect against both gaseous and particulate contaminants.

Features of the particle filter

Particle filter element is made of high-quality microfibre, which, together with accurate manufacturing technology, creates an exceptionally uniform filter element structure.

- PF10 P3 features a high capacity filter element; trapping even the smallest particles, with an efficiency 99,999 %.
- The filter element is extremely water-repellent.
- The vast intake area reduces the likelihood of clogging and resistance.

Features of the gas filters

Scott utilises superior raw material which is activated and impregnated to produce the best performance by Pro2000 filters.

- The microporous structure of the carbon consists of minute capillaries, which give the granules an extended area for adsorption.
- The gas filter features high retention capacity for a long working life.
- Less carbon means lighter filter element and less resistance – a real benefit for the user.
- With a safe margin to EN requirements, Pro2000 gas filters perform effectively using only 220-320 ml of carbon.

HOW TO SELECT A FILTER?

- Will the atmosphere contain sufficient oxygen (21 vol%) throughout the period of exposure?
- Which hazardous substances are likely to be present?
- Which forms do the airborne contaminants take? Are they particles, gases or vapour or indeed a mixture of these.
- What effects can these substances have on the respiratory organs? Special attention is needed if there are several substances that may interact, either by reacting chemically, or by having synergistic adverse health effects.
- What are the concentrations in the atmosphere?
- What are the relevant occupational exposure limits (OEL) or safe exposure levels?

The level of protection required can be calculated as follows:

1. Divide the measured workplace concentration by the OEL-value of the substance	Protection factor needed =	Workplace concentration
2. After that select the respirator, which has a protection factor superior to the required level of protection.		OEL value of the contaminant

Protection factor needed?

Contaminant:	harmful airborne dust	Protection factor 25 is needed and as the calculated value for multiples of the limit show that half mask with P3-filter will provide adequate protection.
Measured concentration	5 mg/m ³ [time-weighted average]	
OEL	0.2 mg/m ³	

The minimum protection factor needed: $5/0.2 = 25$.

What is the maximum permitted concentration of contaminant when using a full face mask with B2-gas filter?

Contaminant	Chlorine (Cl ₂)
OEL	1 ppm

Full face mask with a gas filter has a workplace protection factor of 400, which means that full face mask is allowed to use in multiples of 400 x OEL concentration.

The max concentration can be calculated: $400 \times 1 \text{ ppm (Cl}_2\text{)} = 400 \text{ ppm} = 0,04 \text{ vol.\% of chlorine.}$

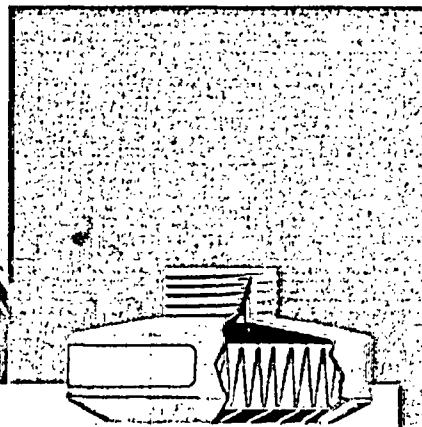

PARTICLES

Particle filter performance

The risk caused by particles depends on

- The physical, biological and chemical properties of the contaminant
- Particle size and form
- Concentration in the ambient air, and exposure time
- Work pace; the more rapid respiration, the more particles are inhaled.

The particle filter element employs a number of mechanisms to remove particles from the air. The basic concept of particle filtration is similar to that of a sieve, which removes all particles down to a certain particle size. Other means include impaction, interception and diffusion.

Particle filter capacity to EN 143.

Class	Capacity	Max permitted penetration		Limits of use Max permitted exposure level
		NaCl (solid, dusts)	Paraffin oil (liquid, aerosols)	
P1	Low capacity (against coarse and minor solid particles)	20 %	20 %	4 x OEL-value
P2	Medium capacity (against solid and liquid hazardous particles)	6 %	6 %	12 x OEL-value
P3	High capacity (against solid and liquid toxic particles as well as radioactive particles and micro-organisms)	0,05 %	0,05 %	With a half mask 30 x OEL value. With a full face mask 400 x OEL value.

Particle filter operation life

- Filter does not wear out but gets clogged with particles and moisture, which results in increased breathing resistance. Particle filter must be changed when breathing becomes burdensome.
- Against radioactive substances, micro-organisms and enzymes, particle filter is recommended on a single use basis.
- The particle filter and combined filter must be changed at the latest when breathing resistance is noticeable.

GASES AND VAPOURS

Gaseous substances

Gaseous impurities have various effects on health

- They can irritate the membranes of respiratory organs, the eyes and skin
- They can reach the lungs and cause damages
- They can be absorbed in the blood and cause temporary or permanent damage to various parts of the body
- They can cause irreparable damage to the nervous system
- The most hazardous gases can intoxicate or suffocate, and even destroy individual bodily organs
- They can be lethal

The effects of the harmful gases depend on

- The characteristics of the gas or vapour; its toxicity and substance
- The concentration of the contaminant in the air
- Duration of exposure to the contaminant
- The chemical compound of the contaminant
- The ability to react chemically with organic tissue as well as the propensity to be absorbed in the blood
- Personal characteristics e.g. rate of respiration, condition of the blood circulation and sensitivity of the person

COMBINED FILTERS

Combined filters remove hazardous gases and vapours as well as solid and liquid particles. The particle filter traps aerosol-based particles such as paint droplets. When spraying liquid substances (e.g. pesticides) a combined filter must be used.

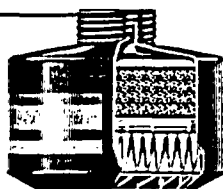
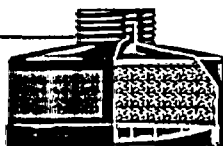

Physiological effects of particulates on human body

Minor effects, inert	effect of concentration, e.g. <math>< 5 \text{ mg/m}^3</math> slight irritation, $> 30 \text{ mg/m}^3$ high irritation
Detrimental, hazardous	changes in lung tissues, e.g. silica dust, quartz, pulmonary fibrosis, e.g. asbestos and other fibres mesothelioma, cancer
Poisonous	e.g. metal fumes, lead, chromium, cadmium, mercury
Airborne radioactive substances	can cause severe damages, e.g. cancer
Micro-organisms, biological agents	can cause hazardous diseases, e.g. farmer's lung

How far the particles penetrates depend on the particle size - the smaller the size the more greater hazard they can cause

Particle size	Pulmonary tract
> 10 μm	Membranes of nose and mouth
> 5 ... 10 μm	Cilia, nose, trachea, bronchi
< 5 μm	In the lungs, pleura
< 1 μm	Alveoli

Particle forms

- **Dusts** are airborne solid particles, which are generated during the processing of organic and inorganic substances. Solid particles can be mineral, metal, coal, wood, or crop dusts as well as various fibres, e.g. asbestos, silicate, fibreglass.
- **Fumes**, evaporating metal creates fumes during cooling. Hot material reacts with oxygen and creates oxides. Lead smelting, for example produces lead oxide fumes; in welding, iron oxide and other metal fumes are produced.
- **Smoke** consists of small coal and soot particles which incorporate both liquid droplets and solid particles.
- **Mists** are airborne droplets which are created when a fluid disperses in air in form of small particles, e.g. oil mists during metal working, when cutting or grinding.
- **Micro-organisms**, e.g. bacteria, viruses, spores.
- **Radioactive particles** are generated as a result of radiation.

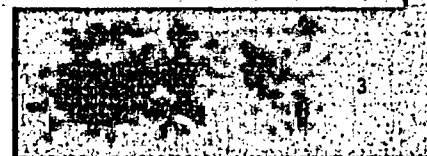

GAS FILTER PERFORMANCE

Examples of gas filter applications

A-FILTER

Filters gases and vapours from organic compounds with a boiling point over 65°C.

Examples of specific hydrocarbons: toluene, benzene, xylene, styrene, turpentine, cyclohexane, carbon tetrachloride, trichloroethylene.

Some solvents are often used as mixtures, e.g. benzene-based solvents, petroleum spirits, mineral turpentine, white spirit, solvent naphtha.

Thinners are solvent mixtures that usually contain toluene, methyl-isobutyl ketone, thisobutanol and ethylene glycol. Other organic compounds: dimethyl formamide, phenol, furfuryl alcohol, diacetone alcohol.

In addition some raw ingredients and additives in plastics, e.g. phthalates, phenol resins, epoxy plastics. Polychlorinated biphenyls as PCB isomers.

B-FILTER

Inorganic gases and vapours

e.g. chlorine, nitrogen dioxide, hydrogen sulphide (H₂S), hydrogen cyanide (HCN), hydrogen chloride (HCl), cyanide compounds, phosphorus and phosphoric acid.

E-FILTER

Organic acids, acid gases and generally gaseous acids, e.g. nitric acid, propionic acid, sulphur dioxide, sulphuric acid, formic acid.

K-FILTER

Ammonia and its organic ammonia derivatives, organic amines such as methylamine, ethylamine, ethylenediamine, diethylamine.

AX-FILTER

Gases and vapours from organic compounds with a boiling point below 65°C.

E.g. acetaldehyde, acetone, butane, butadiene, diethyl ether, dichloromethane, dimethyl ether, ethylene oxide, methanol, methylene chloride, methyl acetate, methyl formate, vinyl chloride.

Note! Certain low boiling organic gases can be filtered with either B- or E- or K-filter, e.g. formaldehyde (B) and methylamine (K), see Scott Health & Safety Instructions for use of AX-filter.

Hg-P3-FILTER

Mercury and its inorganic compounds, organic mercury compounds, mercury alkyls, mercury vapours, ozone.

(Note! Always used as a combined filter).

REACTOR-P3 FILTER

Radioactive iodine and its organic compounds such as methyl iodide (always used as a combined filter).

Gas filter capacity

Class	Capacity	Max gas concentration EN 141. Negative pressure respirators	Max gas concentration. EN 12941 & 12942. Powered respirators
Class 1	Low capacity	1000 ppm (0,1 %)	500 ppm (0,05 %)
Class 2	Medium capacity	5000 ppm (0,5 %)	1000 ppm (0,1 %)
Class 3	High capacity	10 000 ppm (1 %)*	5 000 ppm (0,5 %)

* NOTE! Test gas concentration with A-filter in class 3. is 0,8 vol% (EN141).

Gas filter capacity EN 141

Filter type	Test gas	Minimum allowed breakthrough time for gases in different classes		
		1. class	2. class	3. class
A	Cyclohexane C ₆ H ₁₂	70 min	35 min	65 min (0,8 vol%)
B	Chlorine Cl ₂	20 min	20 min	30 min
	Hydrogen sulphide H ₂ S	40 min	40 min	60 min
E	Hydrogen cyanide HCN	25 min	25 min	35 min
	Sulphur dioxide SO ₂	20 min	20 min	30 min
K	Ammonia NH ₃	50 min	40 min	60 min

Special filters

Filter type	Test gas	Minimum allowed breakthrough time	Test gas concentration
AX [EN 371]	Dimethyl ether CH ₃ -O-CH ₃	50 min	0,05 vol %
	Isobutane C ₄ H ₁₀	50 min	0,25 vol %
Hg-P3 [EN 141]	Mercury vapour Hg	100 hours	1,6 ml/mg

Gas filter classification with powered air respirators EN 12941 and 12942

Filter type	Test gas	Minimum allowed breakthrough time for gas in different classes		
		1. class	2. class	3. class
A	Cyclohexane C ₆ H ₁₂	70 min	70 min	35 min
B	Chlorine Cl ₂	20 min	20 min	20 min
	Hydrogen sulphide H ₂ S	40 min	40 min	40 min
E	Hydrogen cyanide HCN	25 min	25 min	25 min
	Sulphur dioxide SO ₂	20 min	20 min	20 min
K	Ammonia NH ₃	50 min	50 min	40 min

NOTE! The test gas concentrations are different from those of EN 141.

HOW LONG FILTER WORKS?

The service life of a filter depends on

- Concentration and characteristics of the workplace contaminant
- Filter capacity, e.g. filter class, compare workplace concentrations to test values
- Breathing volume and work rate
- Humidity of the air
- Temperature of the atmosphere

Gas filter test performance

Gas filter lifetime is tested by directing the test gas through the filter at 30 l/min, which is equivalent to the volume of air per minute used by an average person carrying out medium heavy work. The filter lifetime can be roughly calculated by comparing the concentration at the workplace and the minimum breakthrough times required for the filter type.

How to calculate lifetime of a gas filter?

$$T = \frac{1\ 000\ 000 \times G}{V \times C}$$

T = Time in minutes

G = Capacity of the gas filter to absorb impurities (g)

V = Breathing rate (l/min)

C = Concentration of the contaminant in the ambient air

PRO2000 FILTERS



PF10 P3



GF 22 A2



GF 22 B2



GF 32 E2



GF 22 K2



GF 22 A2B2



GF 32 A2B2E2K2



GF 32 AX



CF 22 A2-P3



CF 22 B2-P3



CF 32 E2-P3



CF 22 K2-P3



CF 22 A2B2-P3



CF 22 A2B2E1-P3



CF 32 A2B2E2K2-P3

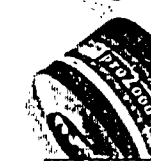

CFR 32 A2B2E2K2-P3



CF 32 AX-P3



CF 32 Reactor-Hg-P3



CF 22 A1E1Hg-P3

Colour code	Filter	Main area of application	Weight g	Ref. nr	Storage time Years
	PF10 P3	Solid and liquid particles, radioactive and toxic particles, plus micro-organisms, e.g. bacteria and viruses.	74	052670	10
	GF22 A2	Organic gases and vapours, e.g. solvents with a boiling point higher than 65°C.	190	042870	5
	GF22 B2	Inorganic gases and vapours, e.g. chlorine, hydrogen sulphide, hydrogen cyanide, fluorine, cyanogen chloride, phosgene.	195	042871	5
	GF32 E2	Acid gases and vapours, e.g. sulphur dioxide, hydrogen fluoride, formic acid, nitric acid.	305	042972	5
	GF22 K2	Ammonia and organic ammonia derivatives.	255	042873	5
	GF22 A2B2	Organic and inorganic gases and vapours.	195	042874	5
	GF32 A2B2E2K2	Organic, inorganic and acid gases and vapours as well as ammonia.	320	042979	5
	GF32 AX	Gases and vapours from organic compounds with a boiling point lower than 65°C.	268	042970	5
	CF22 A2-P3	Organic gases and vapours, e.g. solvents with a boiling point higher than 65°C, solid and liquid, radio-active and toxic particles, plus micro-organisms, e.g. bacteria and viruses.	230	042670	5
	CF32 A2-P3	Inorganic gases and vapours, e.g. chlorine, hydrogen sulphide, hydrogen cyanide, fluorine, cyanogen chloride, phosgene and solid and liquid, radioactive and toxic particles, plus micro-organisms, e.g. bacteria and viruses.	340	043070	5
	CF22 B2-P3	Acid gases and vapours, e.g. sulphur dioxide, hydrogen fluoride, nitric acid, solid and liquid, radioactive and toxic particles plus micro-organisms.	265	042671	5
	CF32 E2-P3	Ammonia and organic ammonia derivatives, solid and liquid, radioactive and toxic particles, plus micro-organisms, e.g. bacteria and viruses.	265	043072	5
	CF22 K2-P3	Organic and inorganic gases and vapours, solid and liquid, radioactive and toxic particles, plus micro-organisms, e.g. bacteria and viruses.	370	042673	5
	CF22 A2B2-P3	Organic, inorganic and acid gases and vapours, solid and liquid particles, radioactive and toxic particles, plus micro-organisms, e.g. bacteria and viruses.	265	042674	5
	CF22 A2B2E1-P3	Organic, inorganic and acid gases and vapours, solid and liquid particles, radioactive and toxic particles, plus micro-organisms, e.g. bacteria and viruses.	270	042678	5
	CF32 A2B2E2K2-P3	Organic, inorganic and acid gases and vapours as well as ammonia and organic ammonia derivatives, solid and liquid, radioactive and toxic particles, plus micro-organisms, e.g. bacteria and viruses.	370	042799	5
	CFR32 A2B2E2K2-P3 (CFR-Reduced opening)	Organic, inorganic and acid gases and vapours as well as ammonia and organic ammonia derivatives, solid and liquid, radioactive and toxic particles, plus micro-organisms, e.g. bacteria and viruses.	370	043699	5
	CF32 AX-P3	Gases and vapours from organic compounds with a boiling point lower than 65°C, solid and liquid, radioactive and toxic particles, plus micro-organisms, e.g. bacteria and viruses.	310	042770	5
	CF32 Reactor-Hg-P3	Mercury and mercury compounds, radioactive iodine and its organic compounds like methyl iodide plus ozone, solid and liquid, radioactive and toxic particles, plus micro-organisms, e.g. bacteria and viruses.	307	042777	5
	CFR32 Reactor-Hg-P3	Mercury and mercury compounds, radioactive iodine and its organic compounds like methyl iodide plus ozone, solid and liquid, radioactive and toxic particles, plus micro-organisms, e.g. bacteria and viruses.	328	043679	5
	CF22 A1E1Hg-P3	Organic and acid gases and vapours, mercury and mercury compounds and ozone, solid and liquid, radioactive and toxic particles, plus micro-organisms, e.g. bacteria and viruses.	268	042778	5

FILTER GUIDE

Explanations

Use air-line = compressed air-line is recommended

Use SCBA = due to the dangerous nature of the hazard use Self Contained Breathing Apparatus

Note!

This filter recommendation is applicable only to Scott Health & Safety filters and should not be used if other filters are used.

Before use of this guide the risk assessment must be done at the workplace. The substances must be identified and measured. Airborne con-

centration levels must be compared with acceptable limits. The maximum exposure limits must not be exceeded! The filtering device must not be used if the environment and contamination are unknown or if the composition of the atmosphere is likely to change disadvantageously. In case of doubt, insulating respirators which function independently from the atmosphere must be used. The filtering

device may be used only if the oxygen content of the air is 18-23 vol. %. Gas filters do not protect against particles. Similarly, particle filters do not provide protection against gases or vapour. In case of doubt, use combined filters. Normal filtering device do not protect against certain gases such as CO (carbon monoxide), CO₂ (carbon dioxide) and N₂ (nitrogen).

Substance	Filter recommendation	Substance	Filter recommendation	Substance	Filter recommendation	Substance	Filter recommendation
A		B		Camphor, synthetic	A-P3	Copper fume, dusts & mists (as Cu)	P3
Acetaldehyde	AX	BGE	A	e-Caprolactam	A-P3	Cotton dust, raw	P3
Acetic acid	A-P3	γ-BHC (ISO)	A-P3	Captafol (ISO)	A-P3	Crotolaldehyde	A
Acetic anhydride	A	Barium compounds	P3	Captan (ISO)	A-P3	Cumene	A
Acetone	AX	Benomyl (ISO)	A-P3	Carbaryl (ISO)	A-P3	Cyanamide	B-P3
Acetonitrile	A	Benzene	A	Carbofuran (ISO)	A-P3	Cyanides, except hydrogen cyanide, cyanogens & cyanogenchloride, (as CN)	B-P3
Acetylene	Use air-line	Benzenethiol	A	Carbon black	P3	Cyanogen	Use air-line
o-Acetylsalicylic acid	P3	Benzene -1,2,4-tri-carboxylic acid	Use air-line	Carbon dioxide	Use air-line	Cyanogen chloride	Use air-line
Acrolein (2-propenal)	AX	1,2 anhydride	A-P3	Carbon disulfide	B-P3	Cyclohexane	A
Acrylaldehyde	AX	Benzidine salts	A-P3	Carbon monoxide	Use air-line	Cyclohexanol	A
Acrylamide	A-P3	Benzidine	A-P3	Carbon tetrabromide	A-P3	Cyclohexanone	A
Acryl acid	A, E	p-Benzoquinone	A-P3	Carbon tetrachloride	A	Cyclohexene	A
Acrylamide	A-P3	Benzoyl peroxide	A-P3	Carbonyl chloride (phosgene)	B-P3	Cyclohexylamine	A
Acrylonitrile	A	Benzyl butyl phthalate	A-P3	Carbonyl fluoride	B	Cyclonite (RDX)	B-P3
Aldrin	A-P3	Benzyl chloride	B-P3	Catechol (Pyrocatechol)	A-P3	1,3 Cyclopentadiene	AX
Allyl alcohol	A	Beryllium compounds	Use SCBA	Cellulose	P3	D	
Allylamine	K	Biphenyl	A-P3	Cement	P3	2,4-D (2,4-Dichlorophenoxy acetic acid)	A-P3
Allylbromine	(B or AX)	Bismuthtelluride	P3	Chlordane (ISO)	A-P3	DDT (Dichlorodiphenyl-trichloroethane)	A-P3
Allyl 2,3-epoxypropyl ether	A	Bismuthtelluride, Se-doped	P3	Chlorinated biphenyls	A-P3	DDVP, see Dichlorvos	A-P3
Allyl chloride	A	Borates, (Tetra) sodium salts	P3	Chlorine	B	Decaborane	B-P3
Allyl glycidyl ether (AGE)	A	Bornan-2-one	A-P3	Chlorine dioxide	B	Demeton	A-P3
Allyl isocyanate	A2B2-P3	Boron oxide	P3	Chlorine trifluoride	B	Diacetone alcohol	A
Allyl propyl disulfide	B	Boron tribromide	Use air-line	Chloroacetaldehyde	A	1,2-Diaminoethane	A, K
Aluminium alkyl compounds	P3	Boron trifluoride	Use air-line	α-Chloroacetophenone (Phenacyl chloride) (CN)	A-P3	Diazinon	A-P3
Aluminium chloride	AX	Bromacil (ISO)	A-P3	Chloroacetyl chloride	A-P3	Diazomethane	B-P3
Aluminium metal and oxide	P3	Bromine	B-P3	Chlorobenzene (Monochlorobenzene)	A	Diborane	Use air-line
Aluminium welding fumes	P3	Bromine pentafluoride	Use air-line	o-Chlorobenzylidene malononitrile (CS)	A-P3	1,2-Dibromoethane	A
Aluminium, soluble salts	P3	Bromochloromethane	AX	2-Chlorobuta-1,3-diene	AX-P3	2-n-Dibutylaminoethanol	A
4-Aminoazobenzene	A-P3	Bromoethane	AX	Chlorodimethyl ether	AX	Dibutyl phosphate	A-P3
4-Aminodiphenyl salts	Use SCBA	Bromoethylene	AX	1-Chloro-2,3-epoxypropane (Epichlorohydrin)	A	Dibutyl phthalate	A-P3
2-Aminoethanol	A	Bromoform	A	Chloroethane	AX	Dichloroacetylene	Use SCBA
2-Aminopyridine	A-P3	Bromomethane	AX	2-Chloroethanol (Ethylene chlorohydrin)	A	1,2-Dichlorobenzene	A
3-Amino-1,2,4-triazole	A	1,3-Butadiene	AX	Chloroethylene	A	1,4-Dichlorobenzene	A
Ammonia	K	Butane	AX	Chloroform (Trichloromethane)	AX	3,3'-Dichlorobenzidine	Use air-line
Ammonium chloride fume	K-P3	Butanethiol	B	bis-Chloromethyl ether	B	1,3-Dichloro-5,5-dimethyl hydantoin	ABE-P3
Ammonium sulfamate (Ammate)	P3	2-Butanone	A	1-Chloro-1-nitropropane	B	1,1-Dichloroethane	AX
n-Amyl acetate	A	2-Butoxyethanol (Butyl cellosolve)	A-P3	Chloropicrin (PS)	A	1,2-Dichloroethane	A
sec-Amyl acetate	A	Butyl acetate	A	B-Chloroprene	AX-P3	Dichloroethyl ether	A
Aniline & homologues	A	sec-Butyl acetate	A-P3	o-Chlorostyrene	A	Dichloromethane	AX
Anisidine, o-, p-Isomers	A-P3	tert-Butyl acetate	A	2-Chlorotoluene	B-P3	1,1-Dichloro-1-nitroethane	A
Antimony and compounds (as SB)	P3	Butyl acrylate	A	2-Chloro-6-(trichloromethyl)pyridine	A-P3	1,2-Dichloropropane	A
Antimony trioxide	P3	n-Butyl alcohol	A	Chloropyrifos (ISO)	A-P3	Dichloropropene	A
p-Aramid respirable fibres	P3	sec-Butyl alcohol	A	Chromates, certain insoluble forms	P3	2,2-Dichloropropionic acid	A
Argon	Use air-line	tert-Butyl alcohol	A	Chromic acid and Chromates (as Cr)	P3	Dichlorvos (DDVP) (ISO)	A-P3
Arsenic & compounds (except Arsine)	P3	N-Butylamine	A	Chromite (chromate) (as Cr)	P3	Dicyclohexyl phthalate	A-P3
Arsenic trioxide	P3	tert-Butyl chromate (as CrO ₃)	P3	Chromium, sol. chromic chromous salts (as Cr)	P3	Dicyclopentadiene	A-P3
Arsine	Use air-line	n-Butylglycidyl ether	A	Coal dust in mines	A-P3	Dicyclopentadiene	A-P3
Asbestos	P3	n-Butyl lactate	A-P3	Coal tar pitch volatiles (as cyclohexane solubles)	A-P3	Dicyclopentadienyliron	A-P3
Asphalt (petroleum fumes)	P3	2-sec Butylphenol	A	Cobalt metal, dust and fume (as Co)	P3	Dieldrin (ISO)	A-P3
Atrazine	P3	p-tert Butyltoluene	A			Diethylamine	K
Azinphos-methyl (ISO)	A-P3						
Aziridine	ABEK						

2-Diethylaminoethanol	K	Fluoride (as F)	P3	Lithium hydride	P3	Neon	Use air-line
Diethylene triamine	A-P3, K-P3	Fluorine	B	Lithium hydroxide	P3	Nickel and inorganic compounds	P3
Diethyl ether	AX	Formaldehyde	AX, B, E			Nickel and organic compounds (as Ni)	A-P3
Diethyl phthalate	A-P3	Formamide	A-P3	M		Nicotine	A-P3
Difluorodibromo- methane	AX	Formic acid	E-P3	Magnesium oxide fume (as Mg)	P3	Nitrapyrin	A-P3
Diglycidyl ether	A-P3	Fuel oils (various)	A-P3	Malathion	A-P3	Nitric acid	E-P3
o-Dihydroxybenzene	A-P3	Furfural	A	Maleic anhydride	A-P3	4-Nitroaniline	AB-P3
Diisobutyl ketone	A	Furfuryl alcohol	A	Manganese & compounds (as Mn)	P3	Nitrobenzene	A-P3
Diisopropylamine	K	G		Manganese fume (as Mn)	P3	4-Nitrobiphenyl	P3
Dimethoxymethane	AX	Gasoline	A	Manganese cyclopentadienyl tricarbonyl	A-P3	Nitroethane	A-P3, (B-P3)
N,N-Dimethyl acetamide	A	Germanium tetrahydride	Use air-line	Manganese tetroxide	P3	Nitrogen dioxide	BE
Dimethylamine	K	Glass, fibrous or dust	P3	Mercury alkyls (as Hg)	Hg-P3	Nitrogen trifluoride	Use air-line
Dimethylaminobenzene	A	Glutaraldehyde	A-P3	Mercury & its inorganic divalent compounds	Hg-P3	Nitroglycerin	A-P3
N,N-Dimethylaniline	A	Glycerol, mist	A-P3	Mesitylene	A	Nitromethane	A-P3
Dimethylbenzene	A	Glycerol trinitrate	A-P3	Mesityl oxide	A	1-Nitropropane	A-P3
Dimethylcarbamyl chloride	A-P3	Glycol ethers	A	Methacrylic acid	A-P3	2-Nitropropane	A-P3
Dimethyl ether	AX	H		Methacrylonitrile	AB-P3	n-Nitrosodimethylamine	A-P3
NN-Dimethylethylamine	K	Hafnium	P3	Methane	Use air-line	Nitrotoluene	A-P3
Dimethylformamide	A	Helium	Use air-line			O	
1,2-Dimethyl- hydrazine	K	Heptan-2-one	A	Methanethiol, see Methyl mercaptan	B	Octachloronaphthalene	A-P3
Dimethyl phthalate	P3	Heptan-3-one	A	Methanol	AX	n-Octane	A
Dimethyl sulphate	AP3	Hexachlorobenzene	A	Methoxyl (ISO)	P3	Oil mist, mineral	P3
Dinitrobenzene	A-P3	Hexachlorocyclo- pentadiene	A	Methoxychlor (ISO)	P3	Osmium tetroxide (as Os)	B-P3
Dinitro-o-cresol	B-P3	Hexachloroethane	A-P3	2-Methoxyethanol (Methyl cellosolve)	A	Oxalic acid	P3
1,4-Dioxane	A-P3	Hexamethyl diisocyanate	A2B2-P3	Methyl acetate	AX	Oxygen difluoride	B
Dioxathion (ISO)	A-P3	Hexamethyl- phosphoramidate	A-P3	Methyl acrylate	A	Ozone	Reactor-Hg-P3 or A1E1Hg-P3
Diphenylamine	A-P3	Hexane (n-hexane)	A	Methyl acrylonitrile	A	P	
Diphenylmethane diisocyanate (MDI)	A2B2-P3	2-Hexanone	A	Methyl alcohol (Methanol)	AX	Paraffin wax fume	A-P3
Dipropylene glycol methyl ether	A	Hexone	A	Methyl alcohol (Methanol)	AX	Paraquat dichloride (ISO)	A-P3
Diquat Dibromide (ISO)	P3	Hexylene glycol	A	Methylamine	K	Parathion (ISO)	A-P3
Disulfoton	ABE-P3	Hydrazine	K-P3	Methyl amyl alcohol	A	Pentachlorophenol	A-P3
2,6-Di-tert-butyl- para-cresol	P3	Hydrazine salts	K-P3	Methyl n-amyl ketone (2-Heptanone)	A	Pentane, all isomers	AX
Diuron (ISO)	P3	Hydrazobenzene	ABEK-P3	Methyl bromide	AX	Perchloroethylene	A
Divinyl benzene	A	Hydrocarbon solvents	A-P3	Methyl-t-butyl ether	AX	Perchloromethyl mercaptan	B
E		Hydrogenated terphenyls	A-P3	Methyl butyl ketone	A	Perchloryl fluoride	B
Emery	P3	Hydrogen bromide	B-P3	Methyl chloroform (1,1,1-Trichloro- ethane)	A	Phenacyl chloride	A-P3
Endosulfan (ISO)	P3	Hydrogen chloride	B-P3	Methyl	A-P3	Phenol	A-P3
Endrin (ISO)	P3	Hydrogen cyanide	B-P3	2-cyanoacrylate	B-P3	n-Phenyl-β- Naphthylamine	A-P3
Epichlorohydrin	A	Hydrogen fluoride (as F)	E-P3	Methylcyclohexane	A	p-Phenylenediamine	P3
1,2-Epoxypropane	AX	Hydrogen peroxide	B-P3	Methylcyclohexanol	A	Phenyl ether (vapour)	A
2,3-Epoxy-1-propanol	A	Hydrogen sulfide	B	2-Methylcyclo- hexanone	A	Phenyl ether-Diphenyl mixture (vapor)	A-P3
Ethanethiol	AX, B	Hydroquinone	A-P3	Methylene bisphenyl diisocyanate (MDI)	A2B2-P3	Phenyl glycidyl ether (PGE)	A
2-Ethoxyethanol	A	2-Hydroxypropyl acrylate	A	4,4'-Methylene-bis (2-chloroaniline)	A2B2-P3	Phenyl hydrazine	A
2-Ethoxyethyl acetate (Cellulosolve acetate)	A	I		MbOCA	A2B2-P3	Phenyl mercaptan	B
Ethyl acetate	A	IGE (2,3-Epoxypropyl isopropyl ether)	A	Methylene bis (4-cyclohexyliso- cyanate)	A2B2-P3	Phenyl phosphine	B
Ethyl acrylate	A	Indene	A	4,4'-Methylene- dianiline (MDA)	A-P3	Phorate	A-P3
Ethyl alcohol (Ethanol)	A	Indium & Compounds (as In)	P3	Methylene chloride	AX	Phosdrin (Mevinphos)	A-P3
Ethylamine	K	Iodine	B-P3	Methyl ethyl ketone peroxideS (MEKP)	A-P3	Phosgene (carbonyl chloride)	B-P3
Ethyl amyl ketone (5-Methyl-3-heptanone)	A	Iodoform	A-P3	Methyl formate	AX	Phosphine	B
Ethylbenzene	A	Iodomethane	AX	Methyl hydrazine	K	Phosphoric acid	P3
Ethyl bromide	AX	Iron oxide, fume (as FE)	P3	Methyl iodide	AX	Phosphorous (yellow)	P3
Ethyl butyl ketone (3-heptanone)	A	Iron pentacarbonyl	A-P3	Methyl isoamyl ketone	A	Phosphorus pentachloride	B-P3
Ethyl chloride	AX	Iron salts	P3	Methyl isobutyl ketone	A	Phosphorus pentasulfide	B-P3
Ethylene chlorohydrin	A	Isoamyl acetate	A	Methyl isocyanate	A2B2-P3	Phosphorus trichloride	B-P3
Ethylene glycol	A-P3	Isoamyl alcohol	A	Methyl methacrylate	A	Phthalic anhydride	A-P3
Ethylene glycol dinitrate and/or Nitroglycerin	A	Isobutane	AX	Methyl parathion	A-P3	Picloram (ISO)	AB-P3
Ethylene glycol mono- ethyl ether acetate	A	Isobutyl acetate	A	Methyl propyl ketone	A	Picric acid	P3
Ethylene oxide	AX	Isobutyl alcohol	A	Methyl silicate	A	Platinum (Soluble salts) (as Pt)	P3
Ethyleneimine	K	Isophorone	A	a-Methylstyrene	A	Polychlorinated biphenyls (PCBs)	A-P3
Ethyl ether	AX	Isophorone diisocyanate	A2B2-P3	Mevinphos (ISO)	A-P3	Polyvinyl chloride (PVC)	P3
Ethyl formate	AX	Isopropyl acetate	A	Molybdenum (as Mo)	P3	Potassium hydroxide	P3
Ethyl mercaptan	AX	Isopropyl alcohol	A	Monochloroacetic acid	A-P3	n-Propanol	A
4-Ethylmorpholine	A-P3	Isopropylamine	B	Monomethyl aniline	A	Propargyl alcohol	A
Ethyl silicate	A	n-Isopropylaniline	A	Morpholine	A	Propiolactone	A-P3
F		Isopropyl benzene (as Cumene)	A	N		Propionic acid	A-P3
Fenchlorofoss (ISO)	A-P3	Isopropyl ether	A	Naphthalene	A-P3	n-Propyl acetate	A
Ferbam (ISO)	P3	Isopropyl glycidyl ether	A	2-Naphthylamine	A-P3	Propyl alcohol	A
Ferrocene (ISO)	A-P3	L				Use air-line	
Ferrovandium dust	P3	Lead and compounds (except lead alkyls)	P3				
Flour dust	P3	Lead alkyls	A-P3				
		Lindane	A-P3				

Substance	Filter recommendation	Substance	Filter recommendation	Substance	Filter recommendation	Substance	Filter recommendation
Propylene glycol	A	Styrene	A	Tetryl (2,4,6-trinitrophenyl-methyl-nitramine)	P3	V	
Propylene glycol dinitrate	A-P3	Subtilisins (Proteolytic enzymes)	P3	Thallium, soluble compounds (as TI)	P3	Vanadium pentoxide	P3
Propylene oxide	AX	Sulfur dioxide	E	4,4'-Thiobis (6-tert-butyl-m-cresol)	P3	Vinyl acetate	A
PyrethrINS (ISO)	P3	Sulfuric acid	E-P3	Thioglycolic acid	A-P3	Vinyl benzene	A
Pyridine	A-P3	Sulfur monochloride	B-P3	Toluene (Toluol)	A	Vinyl bromide	A
Pyrocategol	A-P3	Sulfur pentafluoride	Use	Toluene-2, 4-diisocyanate (TDI)	A2B2-P3	Vinyl chloride	AX
Q		Sulfur tetrafluoride	Use	o-Toluidine	A-P3	Vinylidene chloride	AX-P3
Quartz	P3	Sulfuryl difluoride	Use	Triethylamine	A, K	Vinyl toluene	A
Quinone	A-P3	2,4,5-T (ISO)	P3	Trimethyl benzene	A	VM & P Naphtha	A
R		T		Trimethyl phosphite	A-P3	VX	B-P3
Resorcinol	A-P3	Tabun (GA)	B-P3	1,2,4-Trichlorobenzene	A	W	
Rhodium (as RH) metal fume and dust	P3	Tantalum	P3	1,1,1-Trichloroethane	A	Warfarin (ISO)	P3
Rosin core solder pyrolysis products (as formaldehyde)	B-P3	TEDP	AB-P3	Trichloroethylene	A-P3	Welding fume	P3
S		Tellurium & compounds (as Te)	P3	Trichloromethane	AX	White spirit	A
Sarin (GB)	ABE-P3	Tellurium hexafluoride (as Te)	Use	1,2,3-Trichloropropane	A	X	
Selenium compounds (as Se)	P3	Terphenyls	SCBA	Tricyclohexyltin hydroxide	A-P3	Xylene (all isomers)	A
Silica dust	P3	1,1,1,2-Tetrachloro-2, 2-difluoroethane	A-P3	Triethylamine	A, K	Xylydine, all isomers	AK
Silver, metal	P3	1,1,2,2-Tetrachloro-1, 2-difluoroethane	A	Trimethyl phosphite	A-P3	Y	
Silver soluble compounds (as Ag)	P3	1,1,2,2-Tetrachloro, ethane	A	2,4,6-Trinitrotoluene (TNT)	P	Yttrium	P3
Sodium azide	P3	Tetrachloro-naphthalene	A	Tri-o-tolyl phosphate	A-P3	Z	
Sodium bisulfite	E-P3	Tetrahydrofuran	A	Triphenylamine	A-P3	Zinc chloride, fume	P3
Sodium fluoroacetate	P3	Tetramethyl lead (as Pb)	A-P3	Triphenyl phosphate	A-P3	Zinc chromates (inc. zinc potassium chromate)	P3
Sodium hydroxide	P3	Tetramethyl succinonitrile	A-P3	Tungsten & compounds	P3	Zinc oxide fume	P3
Sodium metabisulfite	P3	Tetranitromethane	B	Turpentine	A	Zirconium compounds (as Zr)	P3
Soman (GD)	B-P3	Tetrasodium pyrophosphate	P3	U			
Stibine	Use			Uranium compounds, natural, soluble (as U)	P3		
Stoddard solvent	A			Urethane (INN)	A-P3		
Strychnine	P3						

Restrictions on use:

- Maximum permitted use time for the mercury filter Hg-P3 is 50 hours (EN 141).
- AX-filter is recommended on a single use basis (EN371).
- Standard filtering respirators do not protect against certain gases, e.g. CO (carbon monoxide), CO₂ (carbon dioxide), N₂ (nitrogen).
- Against radioactive substances, microorganisms and enzymes, particlefilter is recommended on a single use basis.
- If the user can identify the breakthrough of the gas by smell, taste or irritation factor the filter must be replaced.
- When a hazardous gas has an olfactory threshold higher than the occupational exposure limit it produces no clear break through sign. In these cases special directions regarding the calculated lifetime are

required. *Such substances include e.g.: Acetonitrile, Aniline, Benzene, Butyl glycidyl ether, Diaminoethane, Dichloromethane, Diethylaminoethanol, Diglycidyl ether, Dimethyl formamide, 1,4-Dioxane, Epichlorhydrin, Ethyl silicate, Hexane, Hydrogen peroxide, Methyl chloride, Methyl cyclohexanol, Methyl silicate, Methyl cellosolve, Methanol, Methylene chloride, Methyl Isocyanate, 1-Nitropropane, Sulphur hexafluoride, Trichloroethylene, Trichloropropane.*

- The particle filter and combined filter must be changed at the latest when breathing resistance is noticeable.
- An opened gas filter must be used within six months. The above mentioned storage times for the Pro2000 filters are for a factory sealed filter package.

Accessories

052691	Prefilter Pro2000 (set of 20)
052692	Prefilter holder Pro2000 (2 pcs + prefilters (6 pcs)
052690	Spark protector Pro2000 (incl. 2 holders + 2 metal spark covers)
052693	Plastic cover Pro2000 (2 pcs)
052694	Screw plug

tyco / SCOTT
HEALTH & SAFETY

Finland:
Scott Health & Safety Oy
P.O.Box 501
FIN-65101 Vaasa, Finland

Customer service:
Tel.: +358 (0)6 3244 543, -544
Fax: +358 (0)6 3244 591
e-mail: fin-sales@tycoint.com
www.scottsafety.com

United Kingdom:
Scott Health & Safety Limited
Pimbo Road, West Pimbo
Skelmersdale Lancashire WN8 9RA
England

Tel: +44 (0)1695 711711
Fax: +44 (0)1695 711772
e-mail: scottint.uk@tycoint.com
www.scottint.com

ICS 13.280; 13.340.10

Descriptors: Personal protective equipment, clothing, radioactive contamination.

English version

Protective clothing against radioactive contamination

Part 1: Requirements and test methods for ventilated protective clothing against particulate radioactive contamination

Vêtements de protection contre la contamination radioactive - Partie 1: Exigences et méthodes d'essai des vêtements contre la contamination radioactive sous forme de particules

Schutzkleidung gegen radioaktive Kontamination - Teil 1: Anforderungen und Prüfverfahren für belüftete Schutzkleidung gegen radioaktive Kontamination durch feste Partikel

This European Standard was approved by CEN on 1997-11-23. CEN members are bound to comply with the CEN/CENELEC Internal Regulations which stipulate the conditions for giving this European Standard the status of a national standard without any alteration.

Up-to-date lists and bibliographical references concerning such national standards may be obtained on application to the Central Secretariat or to any CEN member.

The European Standards exist in three official versions (English, French, German). A version in any other language made by translation under the responsibility of a CEN member into its own language and notified to the Central Secretariat has the same status as the official versions.

CEN members are the national standards bodies of Austria, Belgium, the Czech Republic, Denmark, Finland, France, Germany, Greece, Iceland, Ireland, Italy, Luxembourg, the Netherlands, Norway, Portugal, Spain, Sweden, Switzerland, and the United Kingdom.

CEN

European Committee for Standardization

Comite Europeen de Normalisation

Europäisches Komitee für Normung

Central Secretariat: rue de Stassart 36, B-1050 Brussels

Contents

Foreword	2
1 Scope	3
2 Normative references	3
3 Definitions	3
4 Requirements.....	4
5 Test methods	8
6 Marking	10
7 Information supplied by the manufacturer.....	10
Annex A (normative)	
Activity sequence for the testing of the protection factor	11
Annex ZA (informative)	
Clauses of this European Standard addressing essential requirements or other provisions of EU Directives	12

Foreword

This European Standard has been prepared by Technical Committee CEN/TC 162 "Protective clothing including hand and arm protection and lifejackets", the secretariat of which is held by DIN.

This European Standard shall be given the status of a national standard, either by publication of an identical text or by endorsement, at the latest by July 1998, and conflicting national standards shall be withdrawn at the latest by July 1998.

This European Standard has been prepared under a mandate given to CEN by the European Commission and the European Free Trade Association and supports essential requirements of EU Directive(s).

For relationship with EU Directive(s), see informative Annex ZA, which is an integral part of this standard.

The annex A is normative and contains the activity sequence for the testing of the protection factor.

Further parts of this standard will deal with requirements and test methods for unventilated protective clothing and protection against liquids and gases.

According to the CEN/CENELEC Internal Regulations, the national standards organizations of the following countries are bound to implement this European Standard: Austria, Belgium, Czech Republic, Denmark, Finland, France, Germany, Greece, Iceland, Ireland, Italy, Luxembourg, Netherlands, Norway, Portugal, Spain, Sweden, Switzerland and the United Kingdom.

1 Scope

This European Standard specifies the requirements and test methods for ventilated protective clothing protecting the wearer against particulate radioactive contamination.

This European Standard does not apply for the protection against ionizing radiation and the protection of patients against contamination with radioactive substances by diagnostic and/or therapeutical measures.

2 Normative references

This European standard incorporates by dated or undated reference, provisions from other publications. These normative references are cited at the appropriate places in the text and the publications are listed hereafter. For dated references, subsequent amendments to or revisions of any of these publications apply to this European standard only when incorporated in it by amendment or revision. For undated references the latest edition of the publication referred to applies.

EN 146

Respiratory protective devices - Powered filtering devices incorporating helmets or hoods - Requirements, testing, marking

EN 270

Respiratory protective devices - Compressed air line breathing apparatus incorporating a hood - Requirements, testing, marking

EN 340

Protective clothing - General requirements

EN 530

Abrasion resistance of protective clothing material - Test methods

EN 863

Protective clothing - Mechanical properties - Test method: Puncture resistance

prEN 943-1

Protective clothing for use against liquid and gaseous chemicals, including liquid aerosols and solid particles - Performance requirements for ventilated and non-ventilated "gas-tight" (Type 1) and "non-gas-tight" (Type 2) protective clothing

EN 1146

Respiratory protective devices for self-rescue - Self-contained open-circuit compressed air breathing apparatus incorporating a hood (compressed air escape apparatus with hood) - Requirements, testing, marking

EN 25978

Rubber- or plastics- coated fabrics - Determination of blocking resistance (ISO 5978 : 1990)

EN 29073-4

Textiles - Test methods for nonwovens - Part 4: Determination of tear resistance

ISO 5082 : 1982

Textiles - woven fabrics - Determination of breaking strength - Grab method

ISO 7854

Rubber- or plastics-coated fabrics - Determination of resistance to damage by flexing

3 Definitions

For the purposes of this standard, the following definitions apply:

3.1 Protective clothing against radioactive contamination

Protective clothing intended to provide protection to the skin and if required to the respiratory tract against radioactive contamination.

3.2 Ventilated protective clothing (against particulate radioactive contamination)

Protective clothing which is supplied with breathable air ensuring internal ventilation and overpressure. This protective clothing provides protection against particulate radioactive contamination for the respiratory tract and the whole body.

3.3 Nominal protection factor (100: Inward leakage (IL))

The ratio of the concentration of contaminant in the ambient atmosphere to the concentration of the contaminant in the suit. The concentrations taken into account are the average concentrations recorded during a standardized test.

3.4 Particulate radioactive contamination

Presence of radioactive substances in or on a material or in a place where they are undesirable or could be harmful.

3.5 Seam

A permanent fastening between two or more pieces of protective clothing material.

3.6 Assemblage

A permanent fastening between two or more different garments, or between protective clothing and accessories, obtained, for example by sewing, welding, vulcanising, gluing.

3.7 Join

A non-permanent fastening between two different garments, or between protective clothing and accessories.

3.8 Closure

A device, for example, zipper, "touch and close" fastener, etc., to close openings for donning or removing the protective clothing.

4 Requirements

4.1 Design

4.1.1 Protective clothing against radioactive contamination shall comply with the general requirements specified in EN 340.

4.1.2 The design of the protective clothing shall be such that the protective clothing is straightforward to put on and take off, and to minimize the risk of contamination. Testing according to "practical performance test" (see 5.2).

4.1.3 The clothing can be designed for single or multiple use.

4.1.4 The ventilated protective clothing (see 3.2) may consist of one or several parts. The clothing may be fitted with a respiratory protective device to enable the wearer to breath in case of failure of the primary air supply.

4.2 Materials

The materials used for protective clothing against particulate radioactive contamination shall meet the requirements according to table 1 after the pretreatment in accordance with 5.1.1 and after the conditioning according to 5.1.2.

Table 1: Requirements for the materials

Requirement	Classification	Test according to	Applicable for	
			reusable materials	single use materials
Abrasion resistance	6 > 2000 Cycles 5 > 1 500 Cycles 4 > 1000 Cycles 3 > 500 Cycles 2 > 100 Cycles 1 > 10 Cycles	EN 530, Method 2 00 abrasive paper according to prEN 943-1 and 9 kPa downward pressure	yes	yes
Flex cracking resistance	6 > 100000 Cycles 5 > 40000 Cycles 4 > 1 5000 Cycles 3 > 5000 Cycles 2 > 2500 Cycles 1 > 1000 Cycles	ISO 7854 Method B	yes	no
Puncture resistance	3 > 100 N 2 > 50 N 1 > 10 N	EN 863	yes	yes
Resistance to blocking (see note 1)	2 no blocking 1 blocking	EN 25978	yes	no
Tear resistance	6 > 150 N 5 > 80 N 4 > 40 N 3 > 20 N 2 > 10 N 1 > 2 N	EN 29073-4	yes	yes
Flammability of materials, visor and ancillary parts	Shall not continue to burn	EN 1146 (single burner test)	yes	yes
<p>NOTE 1: Uncoated materials shall not be tested against resistance to blocking. The test report shall be marked "Not tested against....."</p> <p>NOTE 2: If protection against hazardous chemicals is required then testing has to be carried out according to the relevant chemical standards.</p>				

4.3 Nominal protection factor (100:IL)

Ventilated protective clothing shall be classified according to table 2. Testing according to 5.4 with the necessary activity sequence according to annex A, at the minimum design air flow rate.

Table 2: Leakage

Class	Maximum value of mean inward leakage into the hood during exercise of		Nominal protection factor
	One activity %	All activities %	
5	0,004	0,002	50000
4	0,01	0,005	20000
3	0,02	0,01	10000
2	0,04	0,02	5000
1	0,10	0,05	2000

NOTE 1: Maximum value is calculated as the average performance over all test sequences. NOTE 2: Nominal protection factor is the reciprocal of the IL obtained during all activities (100 : IL)

4.4 Seam strength, Joins and Assemblages

4.4.1 Seam strength

A sample of each type of straight seam construction shall be tested in accordance with A.2 of ISO 5082 : 1982 (Constant-rate-of-traverse). Three specimens of each type of seam shall be tested and the mean of each set of three samples calculated. The garment seam performance shall be classified according to the levels of performance given in table 3 using the lowest result, i.e. the weakest seam type.

NOTE: The test method described in ISO 5082 : 1982 is only applicable to straight seams joining two pieces of material.

Table 3: Classification of seam strength

Class	Seam strength N
5	>300
4	>125
3	> 75
2	> 50
1	> 30

4.4.2 Joins and assemblages

The joins and assemblages between the suit and detachable parts e.g. between gloves and sleeves, boots and trouser legs, shall be tested in accordance with 5.5 and withstand a pull of 100 N.

4.5 Visor

The visor shall comply with table 4. Where antifogging compounds are used or specified by the manufacturer they shall not have an adverse affect on the health of the wearer, or on the clothing.

Table 4: Requirements for the visor

Properties of the visor	Requirement	Testing
Distortion of vision	the loss of sight shall not exceed two scales on the optometrical chart	to read letters on a chart at a distance of 5 m during the practical performance test according to 5.2
Mechanical strength	shall not be visibly damaged in such a way as to be likely to affect the performance of the suit system	according to EN 146

4.6 Air supply system

Couplings and connections shall comply with EN 270.

The connection between the compressed air supply tube and the suit, including attachments, threaded parts, belt or other parts, or means of stabilising the suit to the body shall withstand a 250 N pull when tested according to 5.5 .

NOTE: The test should be performed before the inward leakage test.

4.7 Breathing hose

The breathing hose shall comply with the requirements of EN 270.

4.8 Air flow rate

Two suit systems shall be tested, one of which has to be preconditioned as specified in 5.1.4. When tested the air flow rate into the suit system shall not be less than the manufacturers' minimum design flow rate. The maximum flow rate shall not exceed the maximum as stated by the manufacturer. Test in accordance with 5.3

The flow rate and the distribution of the air into the suit system shall not cause distress to the wearer by local cooling. The heat stress has to be considered. Test in accordance with 5.2.

4.9 Air flow rate warning device

If an audible warning device is incorporated in the suit system it shall comply to EN 270, except for the sound pressure level which may be in the range 85dB(A) to 90 dB(A) when measured at the ears of the wearer. The frequency range of the warning device shall be between 2 000 Hz to 4 000 Hz.

Five warning devices shall be tested, one of which has to be preconditioned as specified in 5.1.4. Testing according to EN 270.

4.10 Supply valve

If a variable continuous flow valve is fitted, it shall comply to EN 270. The valve shall permit to adjust the air flow rate in the range from the minimum to the maximum as specified in 4.8. It shall not be possible to close the valve to restrict the air flow below the minimum design air flow rate.

4.11 Exhaust devices

The suit shall be provided with exhaust devices which shall continue to work correctly after the testing of the pressure in the suit (see 4.1 2), during the practical performance test (see 5.2) and during the determination of the protection factor (see 5.4). Testing in accordance with 5.6.

4.12 Pressure in the suit

The overpressure shall not exceed 1 000 Pa mean and 2 000 Pa peak. A positive pressure shall be maintained. Testing with the maximum air flow rate during the activity sequence as specified in Annex A.

4.13 Carbon dioxide content of the inhalation air

The carbon dioxide content of the inhalation air, determined at the minimum air flow rate, shall not exceed an average of 1,0 % (by volume), tested according to EN 270. Two suits shall be tested, one of which has to be pretreated as specified in 5.1.1 .

4.14 Noise associated with the air supply to the suit

The noise measured in the suit at the ears shall not exceed 80 dB(A) at the maximum manufacturers' design flow rate. Testing in accordance with EN 270. Two suits shall be tested, one of which has to be pretreated as specified in 5.1.1.

5 Test methods

5.1 Test preparations

5.1.1 Pretreatment

When the clothing is intended to be reusable the requirements for the materials or the complete clothing shall be proved after five cycles of cleaning and disinfection according to the manufacturer's instructions for use before testing.

5.1.2 Conditioning

All material samples shall be conditioned by storage at (20 ± 2) °C and (65 ± 5) % relative humidity for at least 24 h. Start each of the tests as specified in 5.1.3 and 5.1.4, within 5 min after removal from the conditioning atmosphere.

5.1.3 Visual Inspection

A visual inspection shall be carried out by the test house prior to the laboratory or the practical performance test. This may entail a certain amount of dismantling of the components of the protective clothing in accordance with the manufacturer's information for maintenance.

5.1.4 Preconditioning for the practical performance test

If the manufacturer does not state the preconditioning atmosphere for the practical performance test, the complete clothing shall be exposed:

- a) for 4 h to a temperature of (-30 ± 3) °C and allowed to return to ambient conditions, followed by
- b) for 4 h to an atmosphere of (60 ± 3) °C at 95 % relative humidity. It shall then be allowed to return to ambient temperature.

5.2 Practical performance test

5.2.1 General

The tests shall be carried out by two test persons at (20 ± 5) °C and a relative humidity of less than 60 %. The test temperature and humidity shall be recorded. The background noise shall not be greater than 75 dB(A).

The test persons shall be selected who are familiar with using such or similar protective clothing. The persons will be drawn from those people certified as fit to do so by the medical officer. The necessity of a medical examination before or supervision during the tests shall be at the testing officers discretion.

Prior to the test there shall be an examination that the suit is in working-condition and that it can be used without danger. If more than one size of clothing is manufactured the subjects are asked to select the appropriate size. Ensure that the air supply is within the specified parameters. Two suits shall be tested, each being tested on one test person.

After fitting the suit each test person is asked "Does the suit fit?". If the answer is "Yes", continue the test. If the answer is "No", replace the test person or the suit.

5.2.2 Procedure

During the test the following activities shall be done in simulation of the practical use of the suit:

- a) the test shall be completed within a total working time of 20 min
- b) walking on the level with regular rate of 5 km/h for 5 min

c) filling a small basket (see figure 1, approximate volume 8 l) with 12 mm chippings (e.g. limestone chippings) or other suitable material from a hopper which stands 1,5 m high and has an opening at the bottom to allow the contents to be shovelled out and a further opening at the top where the chippings may be returned. The person stoops or kneels as he wishes and fills the basket with chippings. He then lifts the basket and empties the contents back into the hopper. This shall be repeated 15 to 20 times in 10 min .

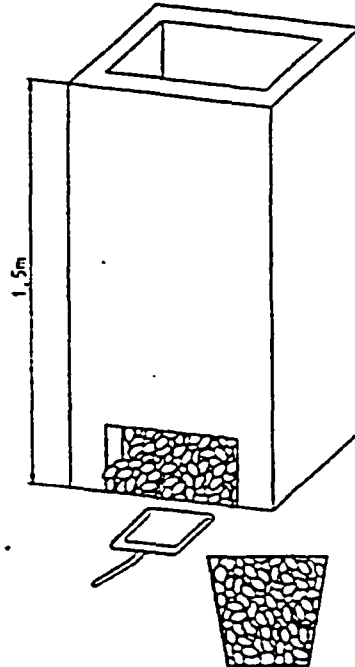

Figure 1: Hopper and basket

5.2.3 Information to be recorded

During the practical performance test the clothing shall be subjectively assessed by the wearer and the following shall be recorded:

- a) harness comfort (see 5.6);
- b) security of fastening and couplings;
- c) accessibility of controls and pressure gauge (if fitted);
- d) clarity and field of vision from the facepiece and/or visor;
- e) clothing comfort;
- f) ease of speech transmission;
- g) any other comments volunteered by the wearer.

5.3 Measurement of minimum and maximum air flow rate

Connect the ends of the distribution system collectively to a suitable measuring device. Record the maximum air flow delivered at the manufacturers' specified air supply, if a control valve is fitted, record the maximum delivered air flow and the minimum delivered air flow.

The value of minimum and maximum air flow rate shall be determined under the condition of exercise 6 of Annex A (person standing still).

5.4 Determination of the protection factor

The protection factor shall be determined in accordance with prEN 943-1. Sodium chloride test method shall be used. Activity sequences for testing are given in Annex A of this standard.

The determination has to be done at the minimum design air flow rate (see 4.8).

On two test subjects four new suits shall be tested. Two suits per test subject.

For each individual test calculate the arithmetic mean over the time period. Calculate the percentage inward leakage (IL) as follows: :-

$$IL = \frac{C_2 \times 100\%}{C_1}$$

where:

C_1 is the challenge concentration in the test chamber,
 C_2 is the mean concentration in the breathing zone for each exercise. For classification according to table 2, the average value for the four suits shall be taken.

5.5 Join and assemblage pull test

Assemble the means of attachment according to the manufacturers' information. If the assembled item (e.g. glove or boot) is itself not strong enough to apply the required pull substitute an item that is. Securely attach one part to a fixed clamp. Apply the required force longitudinally. Record at which force it parts or state that at the required force it was still complete.

5.6 Exhaust device pull test

Mount the suit on to a dummy torso which can be adjusted so that the load can be applied axially to the exhaust device. A system of retaining straps or bands is fitted over the suit around the exhaust device so that the load is applied as directly as possible to the fitting of the exhaust device in the suit.

Exert a force of $(50 \pm 2,5)$ N to the exhaust device and hold for 10 s. Repeat 10 times.

Examine the exhaust device for signs of damage or failure.

6 Marking

The marking shall comply with the specifications of EN 340 with the pictogram as given in figure 2.

The level of performance of the inward leakage (IL) shall be marked as:

IL : class x (x = class number according to table 2).

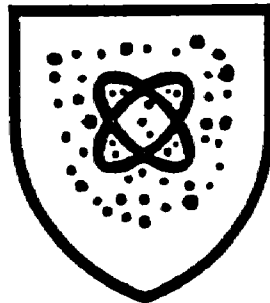

Figure 2: Pictogram

7 Information supplied by the manufacturer

The information supplied shall be at least in the official language(s) of the country or region of application. The manufacturers' information shall comply with the specifications of EN 340. The following information shall be supplied additionally:

- instructions for donning, using, fitting, removing and storing;
- application, limitations of use (classification, temperature range etc.);
- tests to be carried out by the wearer before use (if required);
- maintenance and cleaning and decontamination by e.g. showering (if required).

The manufacturers shall specify the required supply pressure and flow range necessary to maintain protection.

Warnings (if appropriate) shall be given against problems likely to be encountered, as e.g. heat stress, depending on the air flow rate, work load, environmental atmosphere etc.

Annex A (normative)

Activity sequence for the testing of the protection factor

Table A.1: Activity sequence for the testing of the protection factor

No	Activity sequence for the testing	Time of activities min
1	dress person in the suit	
2	don boots, gloves etc. as required according to the manufacturers instructions	-
3	person to enter test chamber, connect tubing to the sample point - no test agent	3
4	establish background reading at sample point with person standing still - no test agent	3
5	start test agent and allow to stabilize	3
6	record leakage and pressure at sample point with the person standing still	3
7	start treadmill	-
8	walk	3
9	record leakage and pressure at sample point with the person walking at about 5 km/h	-
10	stop treadmill	-
11	record leakage and pressure at sample point, person moving arms up and down above head height and looking upward, e.g. lifting object (half brick) from desk to shelf level	3
12	record leakage and pressure at sample point, person doing continuous squats	3
13	stop test agent and allow to disperse with person in chamber	3
14	disconnect sample tubes and remove person from test chamber and undress subject	-
<p>NOTE: The total trial may vary, all times are approximate and are to stable conditions. When doing squats, a slow deliberate action is required, say continuously during about 3 s. Analyse results over final 2 min of each exercise period to avoid carry over of result from one exercise to the other. Record challenge chemical continuously using a separate detector (if possible). Record the pressure inside the suit over the whole time.</p>		

Annex ZA (informative)

Clauses of this European Standard addressing essential requirements or other provisions of EU Directives

This European Standard has been prepared under a mandate given to CEN by the European Commission and the European Free Trade Association and supports essential requirements of EU Directive 89/686/EEC.

WARNING: Other requirements and other EU Directives may be applicable to the product(s) falling within the scope of this standard.

The following clauses of this standard are likely to support requirements of Directive 89/686/EEC, Annex II:

EU-Directive 89/686/EEC, Annex II	clauses of this standard
1.1 Design principles	4.1, 4.2, 4.3, 5.5.1 to 5.6
1.2 Innocuousness of PPE	4.1, 4.5, 4.14, 5.2
1.3 Comfort and efficiency	4.1, 4.3, 5.2, 5.4, annex A
1.4 Information supplied by the manufacturer	clause 7
2.2 PPE 'enclosing' the parts of the body to be protected	4.1.4, 4.5, 4.8, 5.2
2.3. PPE for the face, eyes and respiratory tracts	4.5, 5.2
2.1.2 PPE bearing one or more identification or recognition marks directly or indirectly relating to health and safety	clause 6
3.9.2.1 Protection against external radioactive contamination	clause 4, 5, 6, 7

Compliance with the clauses of this standard provides one means of conforming with the specific essential requirements of the Directive concerned and associated EFTA regulations.

ICS 13.340.30

Supersedes EN 146:1991

Descriptors: accident prevention, personal protective equipment, filters, helmets, classifications, design, specifications, tests, technical notices, marking

English version

Respiratory protective devices — Powered filtering devices incorporating a helmet or a hood — Requirements, testing, marking

(includes amendment A1:2003)

Appareils de protection respiratoire — Appareils filtrants à ventilation assistée avec casque ou cagoule — Exigences, essais, marquage
(inclut l'amendement A1:2003)

Atemschutzgeräte — Gebläsefiltergeräte mit einem Helm oder einer Haube — Anforderungen, Prüfung, Kennzeichnung
(enthält Änderung A1:2003)

This European Standard was approved by CEN on 24 August 1998; Amendment A1 was approved by CEN on 3 November 2003.

CEN members are bound to comply with the CEN/CENELEC Internal Regulations which stipulate the conditions for giving this European Standard the status of a national standard without any alteration. Up-to-date lists and bibliographical references concerning such national standards may be obtained on application to the Central Secretariat or to any CEN member.

This European Standard exists in three official versions (English, French, German). A version in any other language made by translation under the responsibility of a CEN member into its own language and notified to the Central Secretariat has the same status as the official versions.

CEN members are the national standards bodies of Austria, Belgium, Czech Republic, Denmark, Finland, France, Germany, Greece, Hungary, Iceland, Ireland, Italy, Luxembourg, Malta, Netherlands, Norway, Portugal, Slovakia, Spain, Sweden, Switzerland and United Kingdom.

CEN

European Committee for Standardization
Comité Européen de Normalisation
Europäisches Komitee für Normung

Central Secretariat: rue de Stassart 36, B-1050 Brussels

Foreword

This European Standard has been prepared by Technical Committee CEN/TC 79, Respiratory protective devices, the Secretariat of which is held by DIN.

This European Standard replaces EN 146:1991.

This European Standard shall be given the status of a national standard, either by publication of an identical text or by endorsement, at the latest by April 1999, and conflicting national standards shall be withdrawn at the latest by April 1999.

This European Standard has been prepared under a mandate given to CEN by the European Commission and the European Free Trade Association, and supports essential requirements of EU Directive(s).

For relationship with EU Directive(s), see informative annex ZA, which is an integral part of this standard.

According to the CEN/CENELEC Internal Regulations, the national standards organizations of the following countries are bound to implement this European Standard: Austria, Belgium, Czech Republic, Denmark, Finland, France, Germany, Greece, Iceland, Ireland, Italy, Luxembourg, Netherlands, Norway, Portugal, Spain, Sweden, Switzerland and the United Kingdom.

Foreword to amendment A1

This document (EN 12941:1998/A1:2003) has been prepared by Technical Committee CEN/TC 79, Respiratory protective devices, the secretariat of which is held by DIN.

This Amendment to the European Standard EN 12941:1998 shall be given the status of a national standard, either by publication of an identical text or by endorsement, at the latest by June 2004, and conflicting national standards shall be withdrawn at the latest by June 2004.

This document has been prepared under a mandate given to CEN by the European Commission and the European Free Trade Association, and supports essential requirements of EU Directive(s).

According to the CEN/CENELEC Internal Regulations, the national standards organizations of the following countries are bound to implement this European Standard: Austria, Belgium, Czech Republic, Denmark, Finland, France, Germany, Greece, Hungary, Iceland, Ireland, Italy, Luxembourg, Malta, Netherlands, Norway, Portugal, Slovakia, Spain, Sweden, Switzerland and the United Kingdom.

Contents

	Page
Foreword	2
Introduction	3
1 Scope	3
2 Normative references	3
3 Definitions and description	4
4 Designation	4
5 Classification	5
6 Requirements	5

6.1	Materials	5
6.2	Resistance to temperature	6
6.3	Helmets and hoods	6
6.4	Inward leakage	7
6.5	Breathing resistance	7
6.6	Air supply	7
6.7	Checking and warning facilities	7
6.8	Clogging	7
6.9	Electrical components	7
6.10	Breathing hose	8
6.11	Filters	8
6.12	Noise level	12
6.13	Carbon dioxide content of the inhalation air	12
6.14	Resistance to flame	12
6.15	Exhalation means	12
6.16	Mass	13
6.17	Practical performance	13
7	Testing	13
7.1	Conditioning	14
7.2	Visual inspection	15
7.3	Inward leakage	15
7.4	Field of vision	20
7.5	Visor robustness	20
7.6	Breathing resistance	20
7.7	Air supply flow rate	20
7.8	Clogging	22
7.9	Resistance to collapse of breathing hose	22
7.10	Strength of hose and couplings and of connection between hood and breathing hose	22
7.11	Mechanical strength of filters	23
7.12	Filters	23
7.13	Noise level	25
7.14	Carbon dioxide content of the inhalation air	25
7.15	Resistance to flame	26
7.16	Practical performance	27
7.17	Material porosity	28
8	Marking	42
9	Information supplied by the manufacturer	45
	Annex A (normative) Fitting procedure for hoods which seal around the neck and which may or may not incorporate a head harness	46
	Annex B (informative) Marking	49
	Annex ZA (informative) Clauses of this European Standard addressing essential requirements or other provisions of EU Directives	50

Introduction

A given respiratory protective device incorporating a helmet or a hood can only be approved when the individual components satisfy the requirements of the test specification which may be a complete standard or part of a standard, and practical performance tests have been carried out successfully on a complete apparatus where specified in the appropriate standard. If for any reason a complete apparatus is not tested then simulation of the apparatus is permitted provided the respiratory characteristics and weight distribution are similar to those of the complete apparatus.

1 Scope

This European Standard specifies minimum requirements for powered filtering devices incorporating a helmet or a hood with gas, particle or combined filter(s) for respiratory protection. It does not cover devices designed for use in circumstances where there is or might be an oxygen deficiency (oxygen less than 17 % by volume). Also, it does not cover respiratory protective devices designed for escape purposes.

Laboratory and practical performance tests are included for the assessment of compliance with the requirements.

2 Normative references

This European Standard incorporates by dated or undated reference, provisions from other publications. These normative references are cited at the appropriate places in the text and the publications are listed hereafter. For dated references, subsequent amendments to or revisions of any of these publications apply to this European Standard only when incorporated in it by amendment or revision. For undated references the latest edition of the publication referred to applies.

prEN 132:1996, *Respiratory protective devices — Definitions.*

EN 134:1998, *Respiratory protective devices — Nomenclature of components.*

EN 136:1998, *Respiratory protective devices — Full face masks — Requirements, testing, marking.*

EN 140:1998, *Respiratory protective devices — Half masks and quarter masks — Requirements, testing, marking.*

prEN 143:1997, *Respiratory protective devices — Particle filters — Requirements, testing, marking.*

EN 148-1:1987, *Respiratory protective devices — Threads for facepieces — Standard thread connection.*

EN 166:1995, *Personal eye protection — Specifications.*

EN 169:1992, *Personal eye protection — Filters for welding and related techniques — Transmittance requirements and recommended use.*

EN 170:1992, *Personal eye protection — Ultraviolet filters — Transmittance requirements and recommended use.*

EN 171:1992, *Personal eye protection — Infrared filters — Transmittance requirements and recommended use.*

EN 379:1994, *Specification for welding filters with switchable luminous transmittance and welding filters with dual luminous transmittance.*

EN 397:1995, *Industrial safety helmets.*

EN ISO 6941:1995, *Textile fabrics — Burning behaviour — Measurement of flame spread properties of vertically oriented specimens.*

EN 50014:1992, *Electrical apparatus for potentially explosive atmospheres — General requirements.*

EN 50020:1994, *Electrical apparatus for potentially explosive atmospheres — Intrinsic safety “i”.*

IEC 651:1979, *Sound level meters.*

3 Definitions and description

3.1 Definitions

For the purposes of this European Standard the definitions given in prEN 132 and the nomenclature given in EN 134 apply together with the following.

3.1.1

powered filtering device incorporating a helmet or hood device, dependent on the ambient air, incorporating:

- one or more particle filter(s) providing protection against solid or liquid aerosols of negligible volatility and decomposition, or a combination of such aerosols, or
- one or more gas filter(s) providing protection against specified gases and vapours, or
- one or more combined filter(s) providing protection against dispersed solid and/or liquid particles as defined above, and specified gases and vapours
- and a turbo unit supplying the filtered air to a facepiece, which can be a hood or a helmet

3.2 Description

The device typically consists of:

- a) a facepiece which can be a hood as defined in prEN 132 or a device which seals on the face, excluding facepieces specified in EN 136 or EN 140. Either type of facepiece may incorporate a helmet, e.g. to provide head protection against mechanical impact and/or a visor to provide eye and face protection against given risks, possibly combined;
- b) a turbo unit designed to be carried/worn by the wearer which supplies filtered ambient air to the facepiece. The energy supply for the turbo unit may or may not be carried on the person;
- c) a filter or filters through which all air supplied passes;
- d) exhalation valves or other outlets depending on the design by which exhaled air and air in excess of the wearer's demand is discharged.

4 Designation

Respiratory protective devices meeting the requirements of this standard shall be designated in the following manner:

Powered filtering device/EN 12941/ (Class) (type) (options)

for example:

Powered filtering device/EN 12941/TH2A2P SL.

5 Classification

The complete devices are classified and designated according to the maximum inward leakage required as given in Table 1.

Table 1 — Classification

Classification of complete device			Maximum inward leakage %	Maximum particle filter penetration	
Class	Gas filter type and class (if applicable)	Particle filter (if applicable)		NaCl aerosol %	Paraffin oil mist %
TH1	A1, 2 or 3 B1, 2 or 3 E1, 2 or 3 K1, 2 or 3 AX SX	P	10	10	10
TH2	A1, 2 or 3 B1, 2 or 3 E1, 2 or 3 K1, 2 or 3 AX SX	P	2	2	2
TH3	A1, 2 or 3 B1, 2 or 3 E1, 2 or 3 K1, 2 or 3 AX SX Hg NO	P	0,2	0,2	0,2

EXAMPLE TH2B1P, a powered filtering device incorporating a helmet or hood (TH) fitted with a combined gas filter and a particle filter (B1P) and where the inward leakage of the complete device is 2 % or less.

6 Requirements

6.1 Materials

6.1.1 General

The device shall be made of suitable material to withstand normal usage and exposure to those temperatures, humidities and corrosive environments that are likely to be encountered.

Testing shall be done in accordance with 7.2.

6.1.2 Compatibility with skin

Materials that may come into contact with the wearer's skin shall not be known to be likely to cause skin irritation or any other adverse effect to health.

Testing shall be done in accordance with 7.2.

6.1.3 Cleaning and disinfection

The materials used in the construction of the device shall withstand the cleaning and disinfecting agents and procedures recommended by the manufacturer.

Testing shall be done in accordance with 7.2 and 7.3.5.16.

6.1.4 Surface finish

The finish of any part of the device likely to be in contact with the wearer shall be free from sharp edges and burrs.

Testing shall be done in accordance with 7.2.

6.2 Resistance to temperature

After conditioning in accordance with 7.1.2, the complete device excluding filters shall show no appreciable deformation of major components, nor shall these components separate in the complete device. The requirements of 6.3 to 6.10 and 6.12 to 6.17 shall continue to be met.

Testing shall be done in accordance with 7.1.

NOTE 1 The complete device is deemed to exclude the battery charger, unless the charger is integral with the device.

NOTE 2 The requirements for conditioning of filters, prior to testing, are given in 7.1.

6.3 Helmets and hoods

6.3.1 General

If the device is intended to provide in addition head, eye or face protection against those possible risks, it shall comply with relevant requirements of standards covering related protectors (for example EN 166 and EN 397).

Additions to the equipment specified by the manufacturer shall not impair the respiratory protective performance of the equipment complying with the standard.

When the hood or helmet does not include an integral turbo unit:

- a) the hood or helmet shall not incorporate a thread in accordance with EN 148-1;
- b) it shall not be possible to fit the filter(s) directly to the hood or helmet.

6.3.2 Head harness

The head harness (if fitted) of a hood or helmet shall be capable of being adjusted to fit a range of head sizes.

Testing shall be done in accordance with 7.2, 7.3 and 7.16.

6.3.3 Visor

6.3.3.1 Visors shall not distort vision nor shall any misting occur which significantly affects vision as subjectively determined in the course of testing.

Where anti-misting compounds are used or specified by the manufacturer, they shall be compatible with eyes, skin and the device under the foreseeable conditions of use.

Testing shall be done in accordance with 7.3 and 7.16.

6.3.3.2 The effective field of vision shall be not less than 70 %, related to the natural field of vision, and the overlapped field of vision, related to the natural overlapped field of vision, shall be not less than 80 %.

Testing shall be done in accordance with 7.4.

Devices shall also be assessed for field of vision during the practical performance test.

Testing shall be done in accordance with 7.16.

6.3.3.3 If it is intended additionally to provide protection against certain types of non-ionizing radiation then the protection shall comply with EN 166, EN 169, EN 170, EN 171 or EN 379 as appropriate.

If the means of protection against non-ionizing radiation is integral with the equipment covered by this standard then the field of vision shall be measured as described in 7.4 and reported for information only and the equipment shall comply with EN 166, EN 169, EN 170, EN 171 or EN 379 as appropriate.

6.3.3.4 The visor shall not be visibly damaged and the device shall comply with 6.4.

Testing shall be done in accordance with 7.5.

6.4 Inward leakage

When tested at the manufacturer's minimum design flow rate the inward leakage of the test substance for each of the exercises shall not exceed the levels given in the appropriate class from column 5 of Table 1, for each of the 10 test subjects.

Testing shall be done in accordance with 7.3.

6.5 Breathing resistance

The positive pressure under the helmet or hood shall not exceed 5 mbar.

Testing shall be done in accordance with 7.6.

6.6 Air supply

6.6.1 *Clause deleted*

6.6.2 When mounted on a dummy head or torso the flow into the helmet or hood shall be not less than the minimum design flow rate for the manufacturer's stated design duration which shall not be less than 4 h.

Testing shall be done in accordance with 7.7.

The flow rate and distribution of the air under the helmet or hood shall not cause distress to the wearer (for example by excessive local cooling of the head and face or by causing eye irritation).

Testing shall be done in accordance with 7.3 and 7.16.

6.6.3 It shall not be possible to switch off the air supply inadvertently as assessed during the practical performance test.

Testing shall be done in accordance with 7.16.

6.6.4 If a means is provided to adjust the air supply to give a particular classification then it shall not be possible to change the classification during use. The mechanism which adjusts the flow rate shall simultaneously indicate the appropriate reference to the selected classification (see Table 1) as specified in the manufacturer's information. The mechanism shall be so designed that it is not possible inadvertently to change the air flow.

A means for adjusting the air flow during use within a classification may be provided.

Testing shall be done in accordance with 7.2 and 7.16.

6.7 Checking and warning facilities

6.7.1 A means shall be provided to check that the manufacturer's minimum design flow rate is exceeded.

6.7.2 Class TH2 and Class TH3 devices shall be fitted with a warning facility that indicates to the wearer during use when a further check in accordance with 6.7.1 and the manufacturer's instructions is necessary.

6.7.3 A means for checking the correct functioning of the warning facility shall be provided.

6.7.4 The facilities provided under 6.7.1, 6.7.2 and 6.7.3 shall be tested to ensure that it operates at or above the minimum design flow rate.

Testing shall be done in accordance with 7.2, 7.16 and the manufacturer's information.

6.8 Clogging

Where particle or combined filters (including special filters) are fitted, the device shall be tested for clogging. On completion of this test:

- a) the flow rate shall not have fallen below the manufacturer's minimum design flow rate; and
- b) the filters shall meet the penetration requirements of 6.11.1.1.

Testing shall be done in accordance with 7.8.

6.9 Electrical components

Electrical components shall be so designed that it is not possible to inadvertently reduce or reverse the air flow.

If the device is claimed to be intrinsically safe for use in potentially explosive atmospheres it shall comply with the appropriate requirements of EN 50014 and EN 50020.

If the power supply is a battery it shall be a non-spillable type.

Protection against the effects of an occurrence of a short circuit shall be provided for the battery.

Testing shall be done in accordance with 7.2 and 7.16.

NOTE Long power leads should be avoided. The use of very low voltages is recommended, which, in this context, means less than 60 V (d.c.) or less than 25 V (a.c.) (50 Hz).

6.10 Breathing hose

6.10.1 Any breathing hose shall permit free head movement without danger of being caught up, as subjectively assessed by test subjects.

Testing shall be done in accordance with 7.3 and 7.16.

6.10.2 The air flow when the load is applied shall not be reduced by more than 5 % of the manufacturer's minimum design flow rate.

There shall be no distortion 5 min after completion of the test.

Testing shall be done in accordance with 7.9.

6.10.3 Hoses and couplings shall meet the requirements given in Table 2 and shall not become disconnected or visibly damaged. Where multiple hoses are fitted to the device each hose shall meet the requirements given in Table 2.

Testing shall be done in accordance with 7.10.

Table 2 — Strength of hose and couplings

Classification	Strength N
TH1	50
TH2	100
TH3	250

6.10.4 Strength of coupling to hood

The coupling between hose and helmet/hood shall comply with the strength requirements of Table 2 and shall not become disconnected or suffer visible damage.

Testing shall be done in accordance with 7.10.

6.11 Filters

6.11.1 Types and classification

6.11.1.1 Particle filters

Powered particle filtering devices shall be classified according to their penetration as given in columns 5 and 6 of Table 1.

Three levels are classified and shall be designated:

THyP
where y is the inward leakage class 1, 2 or 3.

The protection provided by a class 2 or a class 3 filter includes that provided by the corresponding filter of lower class or classes.

6.11.1.2 Gas filters

Powered gas filtering devices shall be classified according to their application and protection capacity.

They shall be designated:

THyGasz

where *y* is the inward leakage class 1, 2 or 3 and *z* is the capacity of the gas filter 1, 2 or 3 and where "Gas" means one of the "types" of filter listed in a) (i) or (ii) or (iii).

a) Types of filters

Gas filters are contained in one of the following types or combinations of them. If a filter is a combination of types, it shall meet the requirements of each type separately.

i) Types, A, B, E and K

Type A: For use against certain organic gases and vapours with a boiling point higher than 65 °C as specified by the manufacturer.

Type B: For use against certain inorganic gases and vapours as specified by the manufacturer (excluding carbon monoxide).

Type E: For use against sulfur dioxide and other acidic gases and vapours as specified by the manufacturer.

Type K: For use against ammonia and organic ammonia derivatives as specified by the manufacturer.

ii) Special filters

Special filters shall only be in TH3 devices and shall include a particle filter on the inlet side. They are:

Type NO: For use against oxides of nitrogen, e.g. NO, NO₂, NO_x.

Type Hg: For use against mercury.

iii) AX and SX filters

Type AX: For use against certain low boiling compounds (boiling point ≤ 65 °C) as specified by the manufacturer.

Type SX: For use against specific compounds.

b) Classes of filters

i) Gas filters of types A, B, E, and K are classified in one of the following classes:

Class 1: Low capacity

Class 2: Medium capacity

Class 3: High capacity.

The gas capacity provided by a class 2 or class 3 filter includes that provided by the corresponding filter of lower class or classes.

Only one class of special filter is specified.

6.11.1.3 Combined filters

Combined filters shall be specified and described as separate entities in accordance with 6.11.1.1 and 6.11.1.2 that is, THyGaszP (e.g. TH3A2P),

where

y = 1, 2 or 3;

z = 1, 2 or 3; and

Gas = one or more of the types of gas filter.

6.11.2 Design and performance**6.11.2.1 Construction**

The connection between filter(s) and the mating part of the device shall be robust and leaktight.

The connection between filter and the mating part may be achieved by a special type of connection or by a screw thread connection (including threads other than the standard thread).

The standard thread is defined in EN 148-1.

Filters other than prefilters shall be designed to be irreversible and shall be readily replaceable without use of special tools.

The particle filter of combined filters shall be on the influent side of the gas filter.

Testing shall be done in accordance with 7.2.

6.11.2.2 Materials

Internally the filter shall withstand corrosion by the filtering media.

Material from the filter media released by the air flow through the filter shall not constitute a hazard or nuisance for the wearer.

6.11.2.3 Mechanical strength

After testing in accordance with 7.11 filters shall show no mechanical defects. After a visual inspection they shall meet the performance requirements given in 6.11.2.4.

6.11.2.4 Protection efficiency/capacity

6.11.2.4.1 Particle filters

Particle filters shall comply with the requirements given in columns 5 or 5 and 6 of Table 1.

Testing shall be done in accordance with 7.12.1 and 7.12.2.

Filters for use against solid and liquid aerosols shall be tested against sodium chloride and paraffin oil.

Filters only for use against solid and water-based aerosols shall be tested against sodium chloride only.

6.11.2.4.2 Gas filters type A, B, E and K and combined filters

The filters shall comply with the requirements given in Table 3.

Testing shall be done in accordance with 7.12.1, 7.12.3.1 and 7.12.3.2.

Where such a gas filter is combined with a particle filter, the combined filter shall comply with the penetration requirement for the particle filter given in Table 1 in addition to the requirements of Table 3.

6.11.2.4.3 Special filters

Special filters shall comply with the requirements of Table 4 and the penetration requirements for the particle filter given in Table 1.

Testing shall be done in accordance with 7.12.1, 7.12.3.1 and 7.12.3.3.

Only one class of special filter is specified.

6.11.2.4.4 AX filters

AX filters shall comply with the requirements of Table 5 and if applicable with the penetration requirements for the particle filter given in Table 1.

Testing shall be done in accordance with 7.12.1, 7.12.3.1 and 7.12.3.4.

Table 3 — Protection capacity of gas filters of types A, B, E and K

Filter type and class	Test gas	Minimum breakthrough time at test condition min
A1	Cyclohexane (C ₆ H ₁₂)	70
B1	Chlorine (Cl ₂)	20
	Hydrogen sulfide (H ₂ S)	40
	Hydrogen cyanide (HCN)	25
E1	Sulfur dioxide (SO ₂)	20
K1	Ammonia (NH ₃)	50
A2	Cyclohexane (C ₆ H ₁₂)	70
B2	Chlorine (Cl ₂)	20
	Hydrogen sulfide (H ₂ S)	40
	Hydrogen cyanide (HCN)	25
E2	Sulfur dioxide (SO ₂)	20
K2	Ammonia (NH ₃)	50
A3	Cyclohexane (C ₆ H ₁₂)	35
B3	Chlorine (Cl ₂)	20
	Hydrogen sulfide (H ₂ S)	40
	Hydrogen cyanide (HCN)	25
E3	Sulfur dioxide (SO ₂)	20
K3	Ammonia (NH ₃)	40

NOTE The minimum breakthrough times given in Table 3, Table 4, and Table 5 are intended only for laboratory tests under standardized conditions. They do not give an indication of the possible service time of the filter in practical use. Possible service times can differ from the breakthrough times determined according to this standard in both directions, positive and negative depending on the conditions of use.

Table 4 — Protection capacity of special filters

Filter type	Test gas	Minimum breakthrough time at test condition
NOP	Nitric oxide (NO)	20 min
	Nitrogen dioxide (NO ₂)	20 min
HgP	Mercury vapour (Hg)	100 h

NOTE Only one class of special filter is specified.

Table 5 — Protection capacity of AX filters

Test gas	Minimum breakthrough time at test condition min
Dimethyl ether (CH ₃ -O-CH ₃)	50
Isobutane (C ₄ H ₁₀)	50

6.11.2.4.5 SX filters

6.11.2.4.5.1 Sorption

SX filters shall have a breakthrough time of not less than 20 min.

NOTE Minimum breakthrough times are intended only for laboratory tests under standardized conditions. They do not give an indication of the possible service time of the filter in practical use. Possible service times can differ from the breakthrough times determined according to this standard in both directions, positive and negative depending on the conditions of use.

Testing shall be done in accordance with 7.12.1, 7.12.3.1 and 7.12.3.5.

6.11.2.4.5.2 Desorption

The effluent concentration from SX filters shall not be greater than 5 ml/m³ of the test gas at any time during the test.

Testing shall be done in accordance with 7.12.1, 7.12.3.1 and 7.12.3.5.

6.11.2.4.5.3 Where such a gas filter is combined with a particle filter, the combined filter shall comply with the penetration requirement for the particle filter given in Table 1 in addition to the requirements of 6.11.2.4.5.1 and 6.11.2.4.5.2.

6.11.2.4.6 Multiple filters

Where the device employs multiple filters through which the flow is proportioned, the flow through the filters shall be balanced. The flow through multiple filters is considered to be balanced if the filter resistance conforms with the following expression:

$$\left(\frac{|\Delta \text{flow resistance}|}{\text{mean flow resistance}} \right)_{\max} \leq 0,2$$

To assess this balance, the resistance of the filters shall be measured at a flow rate which is given by the manufacturer's minimum design flow rate divided by the number of filters through which the air flow is proportioned.

6.12 Noise level

The noise generated by the device shall not exceed 75 dBA.

Testing shall be done in accordance with 7.13.

6.13 Carbon dioxide content of the inhalation air

The carbon dioxide content of the inhalation air (dead space) shall not exceed an average of 1 % by volume.

Testing shall be done in accordance with 7.14.

6.14 Resistance to flame

No part of the device shall continue to burn after removal from the flame.

Testing shall be done in accordance with 7.15.

The device is not required to meet the other requirements of this standard after being subjected to this test.

6.15 Exhalation means

6.15.1 Where exhalation means are fitted they shall comply with the requirements of 6.15.2 to 6.15.6.

6.15.2 Exhalation means shall be such that they can be readily maintained and correctly replaced.

Testing shall be done in accordance with 7.2.

6.15.3 Exhalation means shall function correctly in all orientations likely to be encountered in use.

Testing shall be done in accordance with 7.2 and 7.16.

6.15.4 Exhalation means shall be protected against dirt and mechanical damage.

6.15.5 Exhalation means shall operate correctly as assessed by the procedures of 7.2, 7.3 and 7.6 after a continuous exhalation flow of (300 ± 15) l/min for a period of (60 ± 6) s. This test shall be carried out immediately after the test described in 7.7.

The batteries shall be recharged in accordance with the manufacturers information before testing the breathing resistance in accordance with 7.6.

6.15.6 The housing of the exhalation means shall be attached to the facepiece so that it can withstand axially a tensile force of (50 ± 15) N for a period of (10 ± 1) s.

Testing shall be done in accordance with 7.10.

6.16 Mass

The total mass of the device shall not exceed 5 kg of which not more than 1,5 kg shall be carried on the head.

6.17 Practical performance

The device shall undergo practical performance tests under realistic conditions. These general tests serve the purpose of checking the device for imperfections that cannot be determined by the tests described elsewhere in this standard.

Where practical performance tests show the device has imperfections related to wearer acceptance, the test house shall provide full details of those parts of the practical performance tests which revealed these imperfections. This will enable other test houses to duplicate the tests and assess the results thereof.

Testing shall be done in accordance with 7.16.

7 Testing

Before performing tests involving human subjects, account shall be taken of any national regulations concerning the medical history, examination or supervision of the test subjects.

If no special measuring devices or measuring methods are specified, commonly used methods and devices shall be applied.

Table 6 — Testing schedule

1	2	3	4	5	6
Requirement clause	Title	Number of samples	Conditioning	Test clause	Cross-referenced clauses
6.1	Materials	2	1A.R., 1T.C.	7.2, 7.3	
6.2	Resistance to temperature	1		7.1, 7.2	6.3 to 6.10, 6.12 to 6.17
6.3	Helmets and hoods	2	1A.R., 1T.C.	7.2, 7.3, 7.4, 7.5, 7.16	6.2, 6.4
6.4	Inward leakage	2	1A.R., 1T.C.	7.3, 7.17	6.2
6.5	Breathing resistance	2	1A.R., 1T.C.	7.6	6.2
6.6	Air supply	2	1A.R., 1T.C.	7.2, 7.3, 7.7, 7.16	6.2
6.7	Checking and warning facilities	2	1A.R., 1T.C.	7.2, 7.16	6.2
6.8	Clogging	2 filters/aerosol	A.R.	7.8	6.2, 6.11.1.1
6.9	Electrical components	2	1A.R., 1T.C.	7.2, 7.16	6.2
6.10	Breathing hose	2	1A.R., 1T.C.	7.3, 7.9, 7.10, 7.16	6.2
6.11	Filters	4 filters/aerosol or gas	2M.S., 2M.S. & T.C.	7.2, 7.11, 7.12	
6.12	Noise level	2	1A.R., 1T.C.	7.13	6.2
6.13	Carbon dioxide content of inhalation air	2	1A.R., 1T.C.	7.14	6.2
6.14	Resistance to flame	2	1A.R., 1T.C.	7.15	6.2
6.15	Exhalation means	2	1A.R., 1T.C.	7.2, 7.3, 7.6, 7.7	6.2
6.16	Mass	2	1A.R., 1T.C.		6.2
6.17	Practical performance	2	1A.R., 1T.C.	7.16	6.2
7.2	Visual inspection	2	1A.R., 1T.C.	7.2	6.1, 6.2, 6.3, 6.6, 6.7, 6.9, 6.11

NOTE For a particular requirement given in columns 1 and 2 of the table, the relevant test clauses are given in column 5. In some cases there are other associated requirement clauses and these are given in column 6.

A.R. = as received (means "not conditioned"); T.C. = temperature conditioned (7.1); M.S. = mechanical strength (7.11).

7.1 Conditioning

7.1.1 General

All tests on complete devices shall be carried out on two samples. One shall be tested "as received" and the other after conditioning in accordance with 7.1.2. Except where otherwise indicated, filters used in the tests with complete devices shall be as "received".

7.1.2 Complete device

Store the complete device for (72 ± 1) h at one of the extremes of temperature and humidity given in the manufacturer's information. Allow the device to return to ambient conditions for at least 4 h and then store for (72 ± 1) h at the other extreme of temperature and humidity given by the manufacturer.

7.3.2 Principle

A test subject, wearing the complete device on test, walks on a horizontal treadmill surrounded by an atmosphere containing a known concentration of the test substance. The flow rate in the equipment is adjusted to, and maintained at, the manufacturer's minimum design flow rate. The percentage inward leakage of the test substance into the breathing zone is measured continuously.

Dilution of the test atmosphere by clean air emanating from the device under test does not affect the accuracy of the measurement of leakage because of the large volume and continuous replacement of the test atmosphere.

7.3.3 Test subjects and number of tests

Two complete devices are tested, each being tested on five test subjects. Both devices shall be tested for robustness of the visor, prior to the inward leakage tests. One complete device is tested "as received" to provide five inward leakage results. The other complete device is tested after being conditioned as described in 6.2 to provide a further five inward leakage results. The test subjects selected shall be familiar with using such or similar equipment. Male and female test subjects shall be used.

7.3.4 Apparatus

The apparatus is used for both test substances.

7.3.4.1 Enclosure

An enclosure is positioned over a treadmill and is capable of being filled with the test atmosphere, which preferably enters the top of the enclosure via a duct and flow distributor and is directed downwards over the head of the test subject. The concentration of the test substance inside the effective working volume is checked to ensure it is sufficiently homogeneous. The enclosure is large enough to permit walking on the treadmill without interference. Provision is made for the positioning of a supplementary fan, not less than 350 mm in diameter, inside the enclosure such that an air velocity of 2 m/s across the enclosure can be produced in the vicinity of the subject's head.

The air velocity through the enclosure measured close to the test subject's head, with the test subject standing centrally on the treadmill and without the supplementary fan in operation, shall be 0,12 m/s to 0,2 m/s.

The design of the enclosure shall be such that the device worn by the test subject can be supplied if necessary with breathable air (free of the test substance). Such an air supply is attached to the filter or equipment normally used with the device.

It is important that the attachment of the hose supplying clean air does not affect the fit of the equipment on the test subject nor should its fitting replace any seals incorporated in the equipment under test. If necessary the hose can be supported.

7.3.4.2 Treadmill

A level treadmill capable of working at 6 km/h.

7.3.4.3 Sampling probe and connections

The probe consists of a length of tubing fitted with a plastics ball of approximately 20 mm diameter and having eight holes each of 1,5 mm diameter spaced equidistantly around the circumference of the ball [see Figure 1a)]. For devices having a rigid visor, the visor may act as a support for the sampling probe after piercing at a suitable position. Connections to the sampling probe need to be sealed into the hole made in the visor.

For devices employing flexible hoods it may be necessary to fit a head harness to the test subject. This harness can then carry the sampling probe and associated connections [see Figure 1b)].

For tests on all types of device, the sample holes in the ball probe should lie in the position shown in Figure 1a) and Figure 1b). A second sampling probe is provided, to measure the ambient concentration of test substance in the test chamber. The sampling probes are connected to the analysing instrument by means of thin tubing the length of which is kept as short as possible.

The sampling is continuous at a rate up to 3 l/min.

7.3.4.4 Detection system

The detection system including sampling probes and connections shall have a response time of less than 20 s for a response of 10 % to 90 % of the full scale deflection of the indicator used.

7.3.4.5 Power supply

The power supply shall enable the manufacturer's minimum design flow rate to be maintained throughout the test procedure. The battery fitted to the device shall not be used.

7.3.5 Test procedure

The test procedure is the same for both test substances.

7.3.5.1 Place all the sample tubes initially in close proximity to one another within the enclosure and the resistance of the sample tubes adjusted, e.g. by means of a screw clip, so that identical readings for the test substance concentration are obtained from each sample tube.

7.3.5.2 Ask the test subject to read the manufacturer's fitting information and if necessary show them how to fit the device correctly in accordance with the fitting information.

7.3.5.3 Inform the test subjects that if they wish to adjust the facepiece during the test they may do so. However, if this is done the relevant section of the test will be repeated having allowed the system to settle.

7.3.5.4 Adjust the flow rate to the manufacturer's minimum design flow rate.

7.3.5.5 After switching on the device and fitting the facepiece ask each test subject "Does the facepiece fit?". If the answer is "Yes", continue the test. If the answer is "No", take the test subject off the panel and report the fact.

7.3.5.6 Ensure that the test subjects have no indication of the results as the test proceeds.

7.3.5.7 Ensure the test atmosphere is OFF.

7.3.5.8 Place the test subject in the enclosure. Connect up the sampling probe. Have the test subject walk at 6 km/h for 2 min. Measure the test substance concentration inside the facepiece to establish the background level.

7.3.5.9 Wait for a stable reading to be obtained.

7.3.5.10 Turn the test atmosphere ON.

7.3.5.11 Instruct the test subject to continue to walk for a further 2 min or until the test atmosphere has stabilized.

7.3.5.12 Whilst still walking, have the test subject perform the following exercises. Exercises b), c) and e) are performed with the supplementary fan operating such that an additional air velocity of 2 m/s is produced to impinge on the front, side and rear of the device in turn.

- a) walking without head movement or talking for 2 min;
- b) turning head from side to side (approximately 15 times), as if inspecting the walls of a tunnel for 2 min;
- c) moving head up and down (approximately 15 times), as if inspecting the ceiling and floor for 2 min;
- d) reciting the alphabet or an agreed text out loud as if communicating with a colleague for 2 min;
- e) walking without head movement or talking for 2 min.

7.3.5.13 Record

- a) chamber concentration; and
- b) the concentration in the breathing zone of the device over each exercise period.

7.3.5.14 Turn off the test atmosphere and when the test substance has cleared from the chamber remove the test subject.

7.3.5.15 Record the subjective assessment by each test subject of misting of the visor.

7.3.5.16 After use by each test subject the device shall be cleaned, disinfected and dried in accordance with the information supplied by the manufacturer before being used for its next inward leakage test.

7.3.5.17 Repeat the procedure with the other nine test subjects but for these the exercises b), c) and e) are performed with the additional air velocity of 2 m/s in one direction only. Ensure that each of the two devices specified in 7.3.3 is used for five test subjects. This will provide four sets of results for each of the directions for the additional air velocity as shown in Table 8 where × indicates that a test is performed and a measurement made. Thus for the ten test subjects, four sets of results for each direction of air flow are obtained.

Table 8 — Additional experimental plan for exercises b), c) and e)

Air flow direction	Exercises	Test subject									
		1	2	3	4	5	6	7	8	9	10
Front	b)	×	×			×			×		
	c)	×	×			×			×		
	e)	×	×			×			×		
Side	b)	×		×			×			×	
	c)	×		×			×			×	
	e)	×		×			×			×	
Rear	b)	×			×			×			×
	c)	×			×			×			×
	e)	×			×			×			×

7.3.6 Test using sulfur hexafluoride as test substance

7.3.6.1 Apparatus

The general arrangement is shown in Figure 2a).

7.3.6.1.1 Test substance: Sulfur hexafluoride

It is recommended that a test atmosphere concentration between 0,1 % and 1 % by volume should be used. Accurate determination of leakage with appropriate instruments are possible within the range from 0,01 % to approximately 20 %, depending on the test concentration.

7.3.6.1.2 Detection means

The concentration of sulfur hexafluoride in the test atmosphere and inside the facepiece of the device is measured and recorded by suitable instruments, ensuring that the response time for the detection system complies with 7.3.4.4.

7.3.6.2 Atmospheric conditions for test

The test is performed at ambient temperature and humidity.

7.3.6.3 Procedure

The procedure specified in 7.3.5 shall be used.

7.3.6.4 Calculation of inward leakage

The inward leakage (P) is calculated from measurements made over the last 100 s of each of the exercise periods to avoid carry over of results from one exercise to the other.

The value of P , expressed as a percentage, is calculated from the equation

$$P(\%) = \frac{C_2}{C_1} \times 100$$

where

C_1 is the challenge concentration; and

C_2 is the measured mean concentration in the breathing zone of the device.

Measurement C_2 is preferably taken via an integrating recorder.

7.3.7 Test using sodium chloride as test substance

7.3.7.1 Apparatus

The general arrangement is shown in Figure 2b).

7.3.7.1.1 Aerosol generator

The sodium chloride aerosol is generated from a 2 % solution of reagent grade sodium chloride in distilled water. A single large Collison atomizer is used, which requires an air flow rate of 100 l/min at a pressure of 7 bar. The atomizer and its housing are fitted into a duct through which a constant flow of air is maintained. It may be necessary to heat or dehumidify the air in order to obtain complete drying of the aerosol particles.

The mean sodium chloride concentration within the enclosure shall be (8 ± 4) mg/m³ and the variation throughout the effective working volume shall not be more than 10 %. The particle size distribution shall be 0,02 µm to 2 µm equivalent aerodynamic diameter with a mass median diameter of 0,6 µm.

7.3.7.1.2 Flame photometer

A flame photometer is used to measure the concentration of sodium chloride inside the facepiece. Essential performance characteristics for a suitable instrument are as follows:

- a) it should be specifically designed for the direct analysis of sodium chloride aerosol;
- b) it should be capable of measuring concentrations of NaCl aerosol between 15 mg/m³ and 5 ng/m³;
- c) the total aerosol sample required by the photometer should not be greater than 15 l/min;
- d) the response time for the photometer, excluding the sampling system, should not be greater than 500 ms;
- e) the response to other elements needs to be reduced. This applies particularly to carbon, the concentration of which will vary during the breathing cycle. The reduced response can be achieved by ensuring that the band pass width of the interference filter is not greater than 3 nm and that all necessary side-band filters are included.

7.3.7.1.3 Sample tubes and pumps

Sample tubes are of plastics tubing with a nominal inside diameter of 4 mm through which air is drawn. If no pump is incorporated into the photometer an adjustable flow pump is used to withdraw an air sample. Dependent on the type of photometer it may be necessary to dilute the sample with clean air. The pump shall be such that aerosol losses are minimized within the pump and changes in flow rate caused by changing pressure within the sampling zone are also minimized.

NOTE Some types of reciprocating diaphragm pumps have proved to be suitable.

The hood/chamber aerosol concentration is monitored during the tests using a separate sampling system, to avoid contamination of the facepiece sampling lines. It is preferable to use a separate flame photometer for this purpose.

If a second photometer is not available, sampling of the hood/chamber concentration using the separate sampling system and the same photometer may be made. However, time will then be required to allow the photometer to return to a clean background.

7.3.7.2 Atmospheric conditions

The test is performed at ambient temperature and a relative humidity of not greater than 60 % in the enclosure when the atomizer is operating.

7.3.7.3 Procedure

The procedure specified in 7.3.5 shall be used.

7.3.7.4 Calculation of inward leakage

The leakage (*P*) is calculated from measurements made over the last 100 s of each of the exercise periods to avoid carry over of results from one exercise to another.

The value of *P*, expressed as a percentage, is calculated from the equation:

$$P(\%) = \frac{C_2}{C_1} \times 1,25 \times 100$$

where

- C*₁ the challenge concentration;
- C*₂ is the measured mean concentration in the breathing zone of the device; and the factor 1,25 is included to allow for lung retention of sodium chloride. It has been derived on the assumption of an air flow rate of the device of 120 l/min and a wearer's breathing rate of 40 l/min.

7.4 Field of vision

The field of vision shall be measured with a Stoll "apertometer" (see Figure 3) modified to support the hood/helmet under test in the same manner as worn. The diagram shown in Figure 4 shall be used for the evaluation. The test shall be carried out with the air supply maintained at the manufacturer's minimum design flow rate.

Field of vision is also assessed during the practical performance test. Results from the apertometer and the practical performance test are used to assess compliance with 6.3.3.2 by means of Table 9.

Table 9 — Use of results from 7.4 and 7.16

	Possible results of test			
	✓	✓	×	×
Stoll test (7.4)	✓	✓	×	×
Practical performance (7.16)	✓	×	✓	×
Meet field of vision requirements (6.3.3.2)	✓	✓	✓	×
✓ Pass × Fail				

7.5 Visor robustness

Mount the complete assembled device on a dummy head supported in the same manner as worn. With the axis of the head form horizontal, impact the centre of the visor by a steel ball (22 mm diameter, mass approximately 44 g) allowed to fall from a distance of 130 cm. The impact shall be perpendicular to the surface of the visor. Carry out the test with the air supply maintained at the manufacturer's minimum design flow rate.

Two visors shall be tested.

7.6 Breathing resistance

Fit the device on the Sheffield dummy head/torso and operate according to the information supplied by the manufacturer with fully charged batteries and clean filter(s). Where appropriate the fitting procedure described in Annex A is used.

Measure the breathing resistance with the device fitted to the artificial head or torso in an upright position, i.e. looking ahead.

Measure the exhalation resistance as a static pressure near the mouth of the dummy to which either a breathing machine adjusted to 25 cycles/min and 2,0 l/stroke or a continuous flow of 160 l/min is applied. Correct the flow rate to 23 °C and 1 bar absolute.

7.7 Air supply flow rate

7.7.1 Principle

The flow of filtered air to the device is measured at zero back pressure and at ambient temperature. The initial flow rate and the flow rate after continuous operation for the manufacturer's stated design duration are measured.

7.7.2 Test equipment

7.7.2.1 *Sheffield dummy head (or torso)*, fitted with mouth tube and pressure port at the mouth.

7.7.2.2 *Suitable blower or suction device*

7.7.2.3 *Control means for blower*, such as a variable power regulator for the motor or an adjustable bleed in the air supply pipework.

7.7.2.4 *Suitable flowmeter*, e.g. calibrated from 50 l/min to 500 l/min.

7.7.2.5 *Micromanometer*, if used, capable of detecting a pressure difference of $\pm 0,01$ mbar.

An inclined liquid manometer or an electronic micromanometer is recommended.

7.7.2.6 *Light weight plastics bag*, as shown in Figure 5 and Figure 6.

7.7.3 Preparation of device

Fit a fully charged battery and new filter(s) to the device.

In order to ensure a fully charged battery the following procedure is recommended. Operate the device normally until there is an audible decrease in air flow. Switch off the device and place the battery on charge in accordance with the manufacturer's information.

7.7.4 Fitting the device into the apparatus

Depending upon the design of the device, fit it into an appropriate apparatus. Examples are shown in Figure 5, Figure 6 or Figure 7. Ensure that all joints are leaktight.

Where an adapter is used care should be taken to ensure that it does not give rise to any pressure/flow losses.

Devices with tight fitting neck seals need to be fitted to the dummy head with the neck seal adjusted as if the device were being worn and with the micromanometer connected to the breathing zone of the visor cavity in such a manner as to be free from velocity effects.

NOTE It is possible that the flow past the pressure port can influence the recorded pressure.

7.7.5 Procedure: initial flow rate

7.7.5.1 Devices tested according to Figure 5 or Figure 6

Switch on the device and adjust the blower (Figure 5) or suction device (Figure 6) until the plastics bag neither inflates nor deflates, i.e. zero back pressure.

The micromanometer should indicate zero pressure but observation of the plastics bag is often a more precise method of monitoring the pressure within such a flexible enclosure.

Record the reading of the flowmeter. Continue to ensure zero back pressure and repeat the flow measurement at intervals of 5 min until a total time of 30 min has elapsed.

Calculate the average of the seven flow measurements and report as the initial flow rate.

7.7.5.2 Devices tested according to Figure 7

Switch on the device and adjust the suction means until the micromanometer indicates zero back pressure.

Record the reading of the flowmeter. Continue to ensure zero back pressure and repeat the flow measurement at intervals of 5 min until a total time of 30 min has elapsed.

Calculate the average of the seven flow measurements and report as the initial flow rate.

7.7.6 Procedure: design duration

After measuring the initial flow rate as described in 7.7.5, disconnect the measuring apparatus from the device and switch off the blower/suction device.

Leave the device running whilst fitted to the dummy head for 1 h less than the manufacturer's design duration and then reconnect the measuring apparatus as in Figure 5, Figure 6 or Figure 7 as appropriate.

Measure and record the flow rate as described in 7.7.5 at a total elapsed time (including the first 30 min for initial flow rate measurement) equal to the manufacturer's design duration.

7.8 Clogging

The test equipment and the test atmosphere shall be that described in EN 143 with the following modifications. At least the filter and the fan shall be in the test atmosphere for the test. New filters and a fully charged battery shall be fitted to the device before starting the clogging procedure. The complete device fitted with a fully charged battery and clean filter(s) shall be tested on a Sheffield dummy head connected to a breathing machine adjusted to 30 l/min (20 cycles/min, 1,5 l/stroke, sinusoidal breathing pattern).

Operate the device in a dolomite dust concentration of (400 ± 100) mg/m³ until the product of dust concentration and the testing time is:

a) Particle filter only

TH1P	400 mg·h/m ³ ,
TH2P	400 mg·h/m ³ ,
TH3P	200 mg·h/m ³ ,

e.g. for TH1P the product may be 400 mg/m³ for 1 h or 300 mg/m³ for 1,33 h;

b) Gas vapour filter only

There is no clogging requirement.

c) Combined filters

TH1(Gas)P	200 mg·h/m ³ ,
TH2(Gas)P	200 mg·h/m ³ ,
TH3(Gas)P	100 mg·h/m ³ ,

where

Gas = gas component of classification;

d) Special filters

100 mg·h/m³.

At the end of the test, take the device out of the dust chamber, clean on the outside if necessary and test for flow rate in accordance with 7.7 and for the penetration requirements at this flow rate in accordance with 7.12.2, except that conditioning is not required.

7.9 Resistance to collapse of breathing hose

7.9.1 Principle

The manufacturer's minimum design air flow is passed through the breathing hose which is subjected to a specified load. The change in air flow is measured.

7.9.2 Apparatus

Two circular plates, 100 mm in diameter and thickness at least 10 mm. One plate is fixed and the other is capable of moving at right angles to the plane of the plates. The moving plate is capable of being loaded to ensure a total force of 50 N can be applied between the plates (see Figure 8).

7.9.3 Procedure

Measure the flow in accordance with 7.7 and record this flow. Place the breathing hose centrally between the two plates and pass the manufacturer's minimum design air flow rate through the hose by means of the turbo unit.

Apply the test force of 50 N (which includes that due to the moveable plate itself) to the hose and measure the air flow in accordance with 7.7.

7.10 Strength of hose and couplings and of connection between hood and breathing hose

Suspend the breathing hose and couplings and apply the appropriate force specified in Table 2 for 10 s to the free end.

Suspend the hood and the breathing hose and apply the appropriate force specified in Table 2 for 10 s to the free end.

Where multiple hoses are fitted to the device, apply the appropriate load to each hose.

Report any damage or failure.

7.11 Mechanical strength of filters

7.11.1 Test equipment

The apparatus as shown schematically in Figure 9 consists of a steel case (K) which is fixed on a vertically moving piston (S), capable of being lifted up 20 mm by a rotating cam (N) and dropping down on to a steel plate (P) under its own mass as the cam rotates. The mass of the steel case shall be greater than 10 kg, and the mass of the base of the equipment shall be at least ten times as much as the case, or the equipment shall be bolted to the floor.

7.11.2 Test procedure

The filters shall be tested as received, removed from their packing but still sealed.

The test rig is operated at the rate of approximately 100 rotations per min for approximately 20 minutes for a total of 2 000 rotations.

The filters shall be placed on their sides in the case (K) so that they do not touch each other during the test, allowing 6 mm horizontal movement and free vertical movement. After testing, any loose material that may have been released from the filter shall be removed prior to performance testing.

7.12 Filters

7.12.1 General

When a single filter of a multiple filter device is tested separately the initial air flow measured in 7.7.5 shall be proportioned equally. If, however, the single filter is intended to be used alone, then the full initial air flow as measured in 7.7.5 shall be used for testing. These are the appropriate test flow rates.

For each test aerosol or test gas, two filters shall be tested after conditioning in accordance with 7.11 only and two in accordance with the conditioning specified in 6.2, still in their packaging or seal and then in accordance with 7.11.

7.12.2 Particle filter efficiency

Filters for use against solid and liquid aerosols shall be tested against sodium chloride and paraffin oil.

Filters shall be tested using the test methods described in prEN 143 after conditioning in accordance with 7.11 and at the appropriate test flow rate as defined in 7.12.1. Where the paraffin oil filter penetration test is used the aerosol concentration shall be $(20 \pm 10) \text{ mg/m}^3$.

7.12.3 Protection capacity of gas filters, special filters, AX filters, SX filters and combined filters

7.12.3.1 General

All performance tests shall be conducted so that the test gas or air will pass through the filter horizontally.

If the gas filter is combined with a particle filter, the combined filter shall be submitted for the penetration test for the particle filter as described in 7.12.2 in addition to the test described in 7.11, 7.12.3.2, 7.12.3.3, 7.12.3.4 and 7.12.3.5, as appropriate.

Protection capacity (minimum breakthrough time) is measured at the appropriate test flow rate as defined in 7.12.1 and at $(70 \pm 2) \%$ relative humidity at $(20 \pm 1) ^\circ\text{C}$ under the conditions given in Table 10, Table 11, or Table 12 or in 7.12.3.5.

7.12.3.2 Protection capacity of A, B, E and K filters

Any convenient experimental method may be employed for obtaining the specified influent concentration, and for measuring the effluent concentration, provided they conform to the following limits:

influent concentration: within $\pm 10 \%$ of specified value;

effluent concentration: within $\pm 20 \%$ of specified value.

The recorded breakthrough time shall be adjusted if necessary by simple proportion to conform with the specified influent concentration.

7.12.3.3 Protection capacity of special filters

Special filters shall be tested under conditions given in Table 11.

7.12.3.4 Protection capacity of AX filters

AX filters shall be tested under the conditions given in Table 12.

Table 10 — Test conditions for A, B, E, K filters

Filter type and class	Test gas	Test gas concentration		Breakthrough concentration ml/m ³
		% by volume	mg/l	
A1	Cyclohexane (C ₆ H ₁₂)	0,05	1,8	10
B1	Chlorine (Cl ₂)	0,05	1,5	0,5
	Hydrogen sulfide (H ₂ S)	0,05	0,7	10
	Hydrogen cyanide (HCN)	0,05	0,6	10 (*)
E1	Sulfur dioxide (SO ₂)	0,05	1,3	5
K1	Ammonia (NH ₃)	0,05	0,4	25
A2	Cyclohexane (C ₆ H ₁₂)	0,1	3,5	10
B2	Chlorine (Cl ₂)	0,1	3,0	0,5
	Hydrogen sulfide (H ₂ S)	0,1	1,4	10
	Hydrogen cyanide (HCN)	0,1	1,1	10 (*)
E2	Sulfur dioxide (SO ₂)	0,1	2,7	5
K2	Ammonia (NH ₃)	0,1	0,7	25
A3	Cyclohexane (C ₆ H ₁₂)	0,5	17,5	10
B3	Chlorine (Cl ₂)	0,5	15,0	0,5
	Hydrogen sulfide (H ₂ S)	0,5	7,1	10
	Hydrogen cyanide (HCN)	0,5	5,6	10 (*)
E3	Sulfur dioxide (SO ₂)	0,5	13,3	5
K3	Ammonia (NH ₃)	0,5	3,5	25

(*) C²N² may sometimes be present in the effluent air. The total concentration of (C²N² + HCN) shall not exceed 10 ml/m³ at breakthrough.

Table 11 — Test conditions for special filters

Filter type	Test substance	Test substance concentration in air		Breakthrough concentration
NOP	Nitric oxide (NO)*	0,25 % by volume	3,1 mg/l	5 ml/m ³ **
	Nitrogen dioxide (NO ₂)*	0,25 % by volume	4,8 mg/l	5 ml/m ³ **
HgP	Mercury vapour (Hg)	1,6 ml/m ³	(13 ± 1) mg/m ³	0,1 mg/m ³

* The test gas shall be at least 95 % pure. This is probably best obtained as compressed gas in cylinders.
 ** Both NO and NO₂ may be present in the effluent air. The total concentration of (NO + NO₂) shall not exceed 5 ml/m³.

Table 12 — Test conditions for AX filters

Test substance	Test substance concentration in air		Breakthrough concentration ml/m ³
Dimethyl ether (CH ₃ -O-CH ₃)	0,05 % by volume	0,95 mg/l	5
Isobutane (C ₄ H ₁₀)	0,25 % by volume	6,0 mg/l	5

7.12.3.5 Protection capacity of SX filters

Protection capacity (sorption and desorption) of SX filters shall be assessed using the following procedures.

a) Sorption

Use as test gas/gases those against which the filters are intended to give protection:

The test gas concentration shall be 0,5 % by volume.

The breakthrough concentration shall be 5 ml/m³.

b) Desorption

Load the filters with the test gas for 10 min under the same conditions as for the sorption test.

After dosing, the filters shall be sealed and stored at approximately 20 °C for a period of (3 ± 1) days.

After storage, pass clean air, at the appropriate test flow rate as specified in 7.12.1 at (20 ± 1) °C and (70 ± 2) % RH through the filter for a period of 2 h. The concentration of the test gas in the effluent air shall be monitored during the desorption test.

7.13 Noise level

7.13.1 Principle

The device is worn by a test subject and the noise level in dBA measured at the test subject's ears.

7.13.2 Apparatus

7.13.2.1 *Microphones*, capable of being fitted at the test subject's ears.

7.13.2.2 *Sound level meter*, of type 1 or 2 as specified in IEC 651.

7.13.3 Procedure

7.13.3.1 Calibrate the sound level meter in accordance with the manufacturer's information.

7.13.3.2 Ensure that the device to be tested is equipped with a fully charged battery and one of the filter types designed to be used with the device.

7.13.3.3 Fix the microphones to the test subject at the centres of each of the external ears and level with the tragus.

7.13.3.4 Have the test subject don the device.

7.13.3.5 Switch on the power supply on the device and measure, in succession, the sound pressure level at each of the two ears with the sound level meter set to indicate "A" weighting frequency characteristics.

7.13.3.6 Check that the background noise level in the test room is not less than 10 dBA lower than that measured for the device and adjust the background level as necessary to meet this condition.

7.13.3.7 Report the higher of the results as the noise generated by the device as experienced by the wearer.

7.13.3.8 Repeat the procedure for the complete set of filter types designed to be used with the device.

7.14 Carbon dioxide content of the inhalation air

7.14.1 Principle

The device is fitted to a Sheffield dummy head/torso and operated at the minimum design flow rate. Breathing air is supplied at a specified rate from a breathing machine and the inhaled air is analysed for carbon dioxide content.

7.14.2 Test equipment

A typical test arrangement using a single cylinder breathing machine is shown in Figure 10.

7.14.2.1 Breathing machine, and associated equipment with solenoid valves controlled by the breathing machine.

7.14.2.2 Auxiliary lung.

7.14.2.3 Sheffield head/torso.

7.14.2.4 Carbon dioxide flowmeter, analysers and absorber. The carbon absorber is necessary to prevent build-up of carbon dioxide in the test equipment circuit.

7.14.2.5 Where appropriate, *means for setting up and testing hooded devices which do not have a head harness and which seal around the neck*, (see Annex A).

7.14.3 Procedure

Adjust the breathing machine to give air at 25 cycles/min and 2,0 l/stroke.

Adjust the carbon dioxide supply into the breathing machine to 2,5 l/min via a control valve, a flowmeter, a compensating bag and non-return valves.

Check the carbon dioxide content of the exhaled air and adjust as necessary to give 5 % by volume measured on a dry bases. Ensure that the sample drawn off for analysis is returned to the test circuit to maintain the correct volumetric flow.

Fit the device to the sheffield head/torso and operate at the manufacturer's minimum design flow rate.

Draw off a sample of the inhaled air during the inhalation phase by the auxiliary lung set at a rate of 100 ml displacement/stroke.

Measure the carbon dioxide concentration in the sample by means of the analyser. Continue the test until a steady value is obtained. Record this value as the uncorrected level of carbon dioxide in the inhaled air.

Measure the ambient carbon dioxide level 1 m in front of and level with the tip of the nose of the dummy head. Take the measurement once a stabilized level for carbon dioxide in the inhalation air has been attained. Alternatively, measure the ambient level at the sampling tube with the carbon dioxide supply turned off. The reference level shall be below 0,1%.

Subtract the laboratory ambient carbon dioxide level from the measured value in the inhaled air.

7.14.4 Procedure for hooded devices which seal around the neck and which may or may not incorporate a head harness

The procedure given in Annex A shall be used.

7.14.5 Report

Report the carbon dioxide content of the sample when a steady value has been obtained.

7.15 Resistance to flame

7.15.1 Principle

The facepiece or other component of the device is mounted either on a metallic dummy head (facepiece) or in a suitable manner on a rotating support arm and passed through a flame and the effects of the flame on the device observed.

7.15.2 Apparatus

7.15.2.1 Metallic dummy head, mounted on a support which enables it to be rotated to describe a horizontal circle (see Figure 11).

Facility, enable attachment of any other parts of the device to the rotating support.

7.15.2.2 Gas supply rig, consisting of a propane storage tank with flow control valve and pressure gauge, flashback arrester and a propane burner. The burner shall be adjustable in height.

A "TEKLU" burner or that described in EN ISO 6941:1995 has been found suitable¹⁾.

7.15.3 Procedure

7.15.3.1 Facepiece

Fit the device to the dummy head and ensure that a speed of rotation of (60 ± 6) mm/s can be obtained.

7.15.3.2 Other components

Fit the component to the support arm at such a radius that a speed of rotation of (60 ± 6) mm/s can be obtained.

7.15.3.3 Rotate the head and device or component so that it is over the burner. Adjust the position of the burner such that the distance between the top of the burner and the lowest part of the device which is to pass through the flame is (20 ± 2) mm. Rotate the head away from the burner.

Ignite the gas at the burner. Ensure that the burner air vent is fully closed and adjust the flow control valve to give a flame height approximately 40 mm above the burner top. These settings shall be adjusted to give a flame temperature of (800 ± 50) °C at a point (20 ± 2) mm above the burner top.

Pass the device or component once through the flame at the set speed of (60 ± 6) mm/s.

Repeat the test to enable an assessment to be made of all materials on the exterior of the device. Any one component shall be passed through the flame once only.

7.15.4 Assessment and test report

Examine the device or component after it has passed through the flame and report whether it continues to burn.

7.16 Practical performance

7.16.1 Principle

Test subjects wearing the device carry out activities in simulation of practical use. The test subjects are then asked to assess subjectively the device for ease of use.

7.16.2 Test subjects

Two test subjects are used, the medical history of whom is known to be satisfactory. The necessity of a medical examination before, and supervision during, the test is decided by the test officer.

7.16.3 Test conditions

The test is carried out in an atmosphere of (20 ± 5) °C and a relative humidity of (60 ± 15) %. The noise level in the area shall be not greater than 75 dBA. The actual conditions shall be recorded.

7.16.4 Procedure

Two devices shall be used in the test each fitted with fully charged battery(s) and clean filters.

Each test subject is asked to use the device in accordance with the information supplied by the manufacturer and the following sequence of activities is carried out in a total of 30 min.

The order in which the activities are done is at the discretion of the test officer:

- a) walking on the level at a regular rate of 6 km/h for 10 min;
- b) walking on the level with headroom of $(1,3 \pm 0,2)$ m for 5 min;
- c) crawling on the level with headroom of $(0,70 \pm 0,05)$ m for 5 min;
- d) filling a small basket with suitable 12 mm chippings from a hopper which stands 1,5 m high and has an opening at the bottom to allow the contents to be shovelled out and a further opening at the top where the chippings may be returned. The test subject stoops or kneels as desired and fills the basket with chippings. The test subject then lifts the basket and empties its contents back into the hopper. The procedure is repeated 19 times in 10 min.

¹⁾ Information on a source of a supply of a suitable burner may be obtained from the Secretariat of CEN/TC 79.

The test subject then removes the device and the procedure is repeated for the other test subject wearing the other device.

7.16.5 Test report

After completing the procedure, each test subject is asked to comment on the following:

- a) head harness comfort;
- b) harness or belt comfort;
- c) ease of donning and doffing;
- d) security of fastening and couplings;
- e) accessibility of any controls fitted;
- f) clarity and field of vision including misting;
- g) speech transmission;
- h) the balance of the device in use;
- i) any inadvertent operation of the "on-off" switch or of any means of changing flow rate or classification;
- j) whether the flow rate and distribution of air cause any stress or discomfort;
- k) ease of operation of the checking facilities;
- l) the operation of the warning facility;
- m) freedom of head movement with respect to breathing hose (if fitted);
- n) any other aspect on which the wearer may wish to comment.

7.17 Material porosity

7.17.1 Principle

A specified air pressure is applied to the material which is wetted by a liquid and has a film of the same liquid applied to its upper surface. If a bubble appears on the upper surface the material is rated as porous for the purposes of determining which method is to be used for the determination of inward leakage.

7.17.2 Apparatus

A suitable form of apparatus is shown in Figure 12.

7.17.2.1 Testing head

A testing head consists of a cylindrical vessel over which the test specimen is clamped by a clamping ring and screw. The head is fitted with a synthetic rubber gasket to make a seal against the test specimen.

7.17.2.2 Test liquid

Water in which a wetting agent (softener or washing-up liquid) is dissolved to form a solution by adding a few drops to 1 l of water.

7.17.2.3 Pressure measuring device

7.17.2.4 Air supply and control valves

7.17.3 Testing atmosphere

Carry out the test at normal ambient temperature and relative humidity.

7.17.4 Preparation of test specimens

Take the test specimens from different places in the device in order that an assessment can be made of all materials and seams.

Condition the test specimens for at least 24 h at normal ambient temperature and relative humidity.

7.17.5 Procedure

Soak the conditioned test specimen under approximately 15 mm of test liquid for a period of not less than 3 min. Remove the test specimen from the test liquid and clamp it in the testing head. Pour a few millilitres of test liquid onto the surface of the test specimen.

Apply pressure to the undersurface of the test specimen until bubbles escape, up to a maximum of 100 mbar.

Note whether any bubbles escape over the upper surface of the test specimen indicating that the material is porous.

Repeat the test with the other test specimens.

7.17.6 Report

Report whether or not the fabric has been assessed as porous.

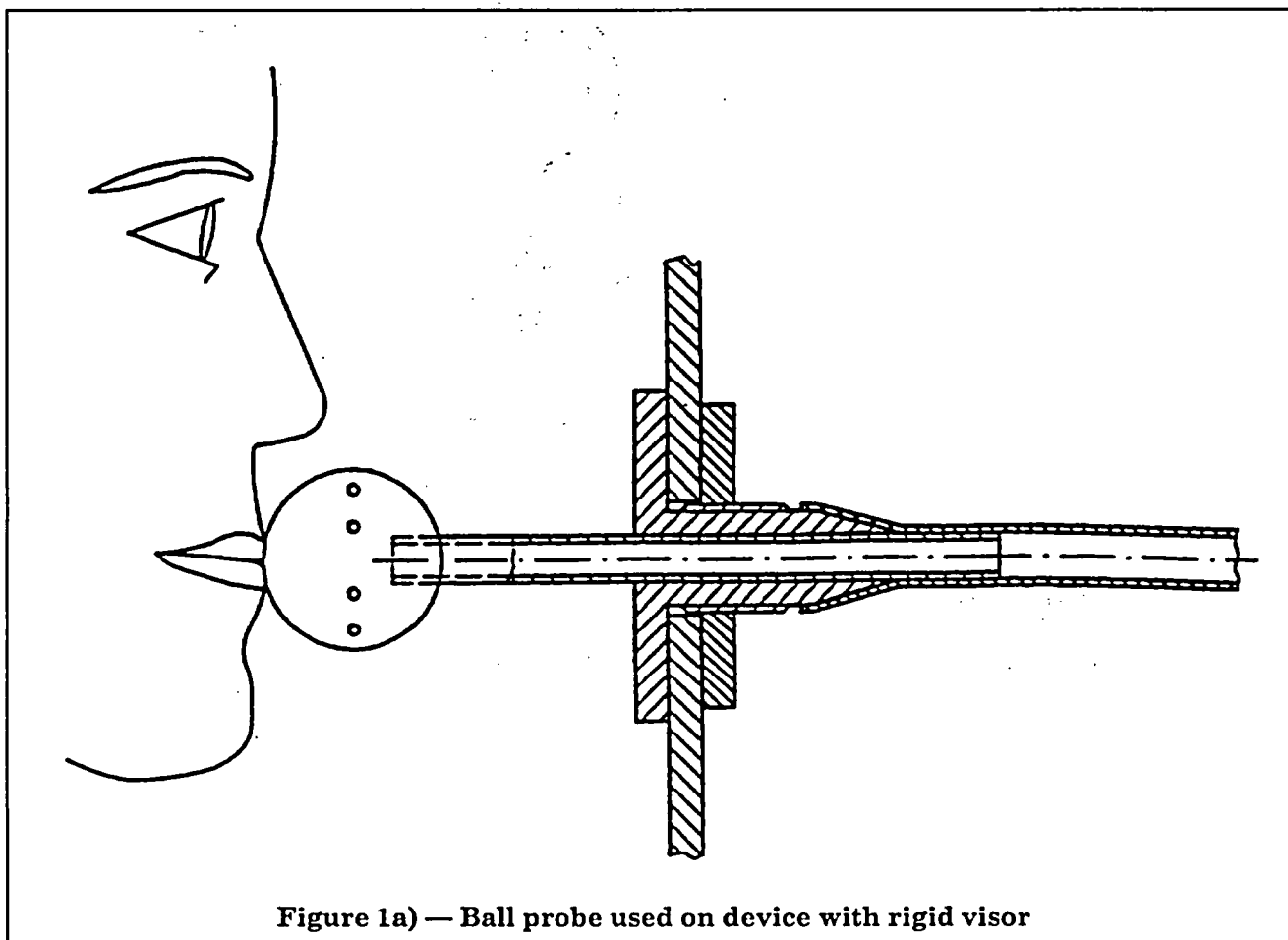
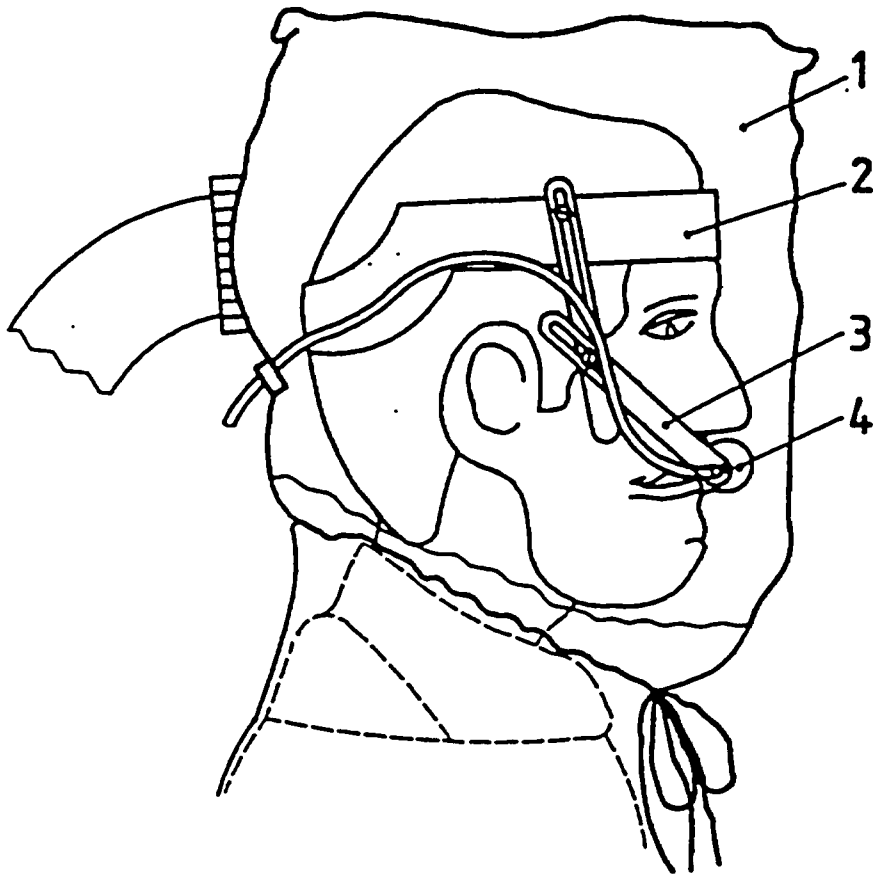

Figure 1a) — Ball probe used on device with rigid visor



1 Hood under test
2 Headband

3 Adjustable plastics arm
4 Sampling probe

Figure 1b) — Typical arrangement for sampling from device with “soft” plastics hood

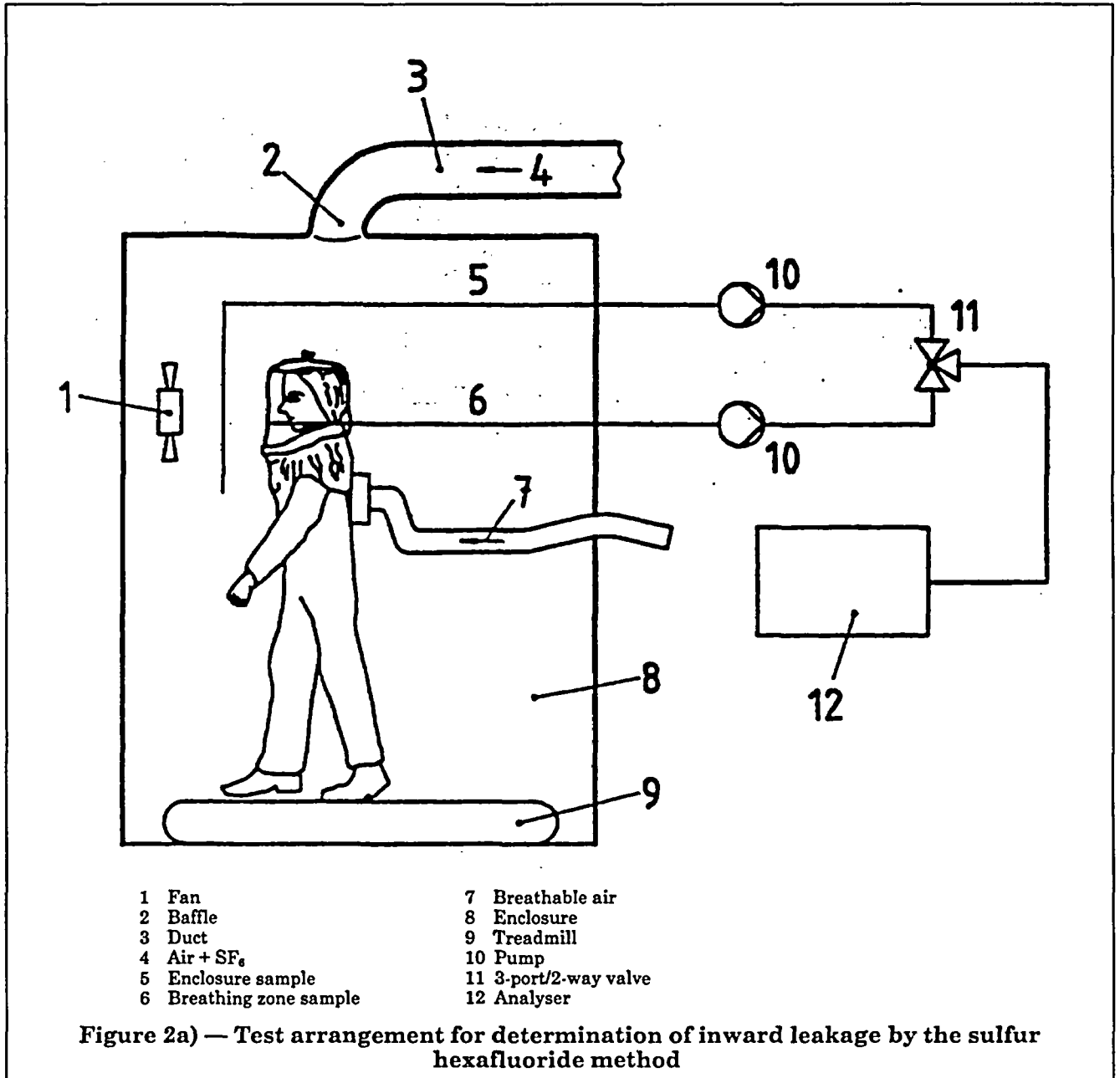

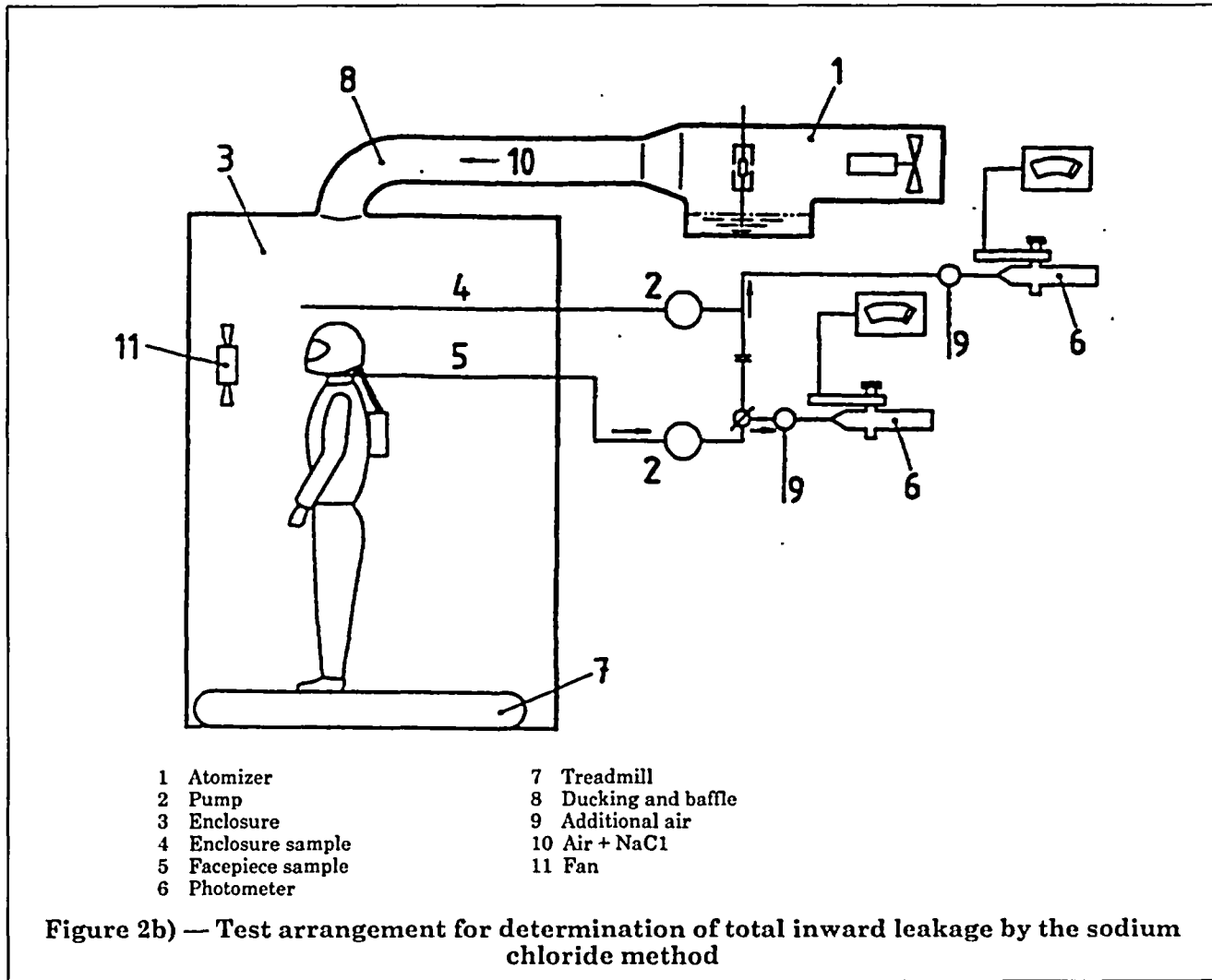

Dimensions in millimetres

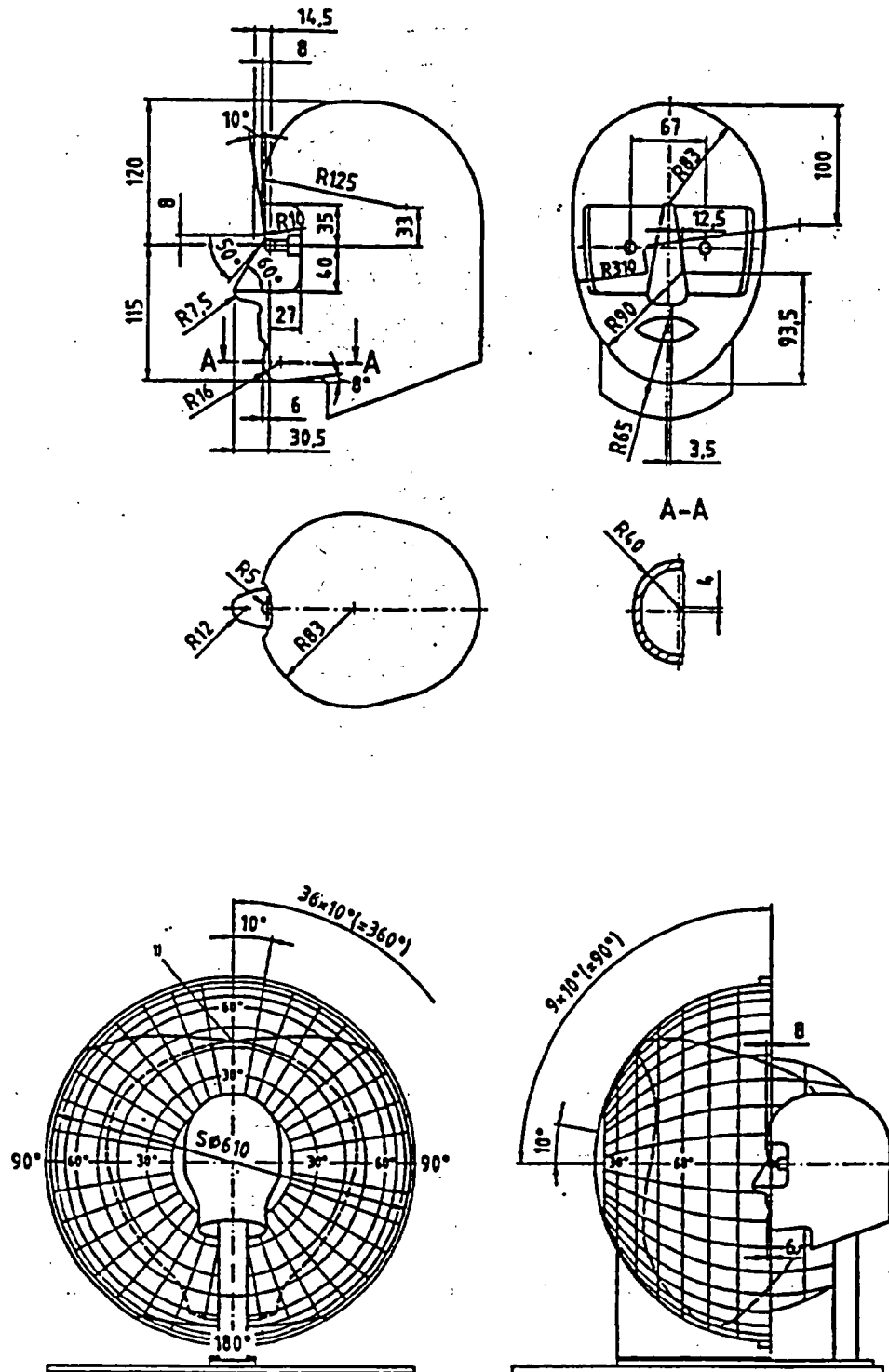

1) Transfer the natural field of vision with the natural overlapped field of vision to the diagram

Figure 3 — Stoll apertometer

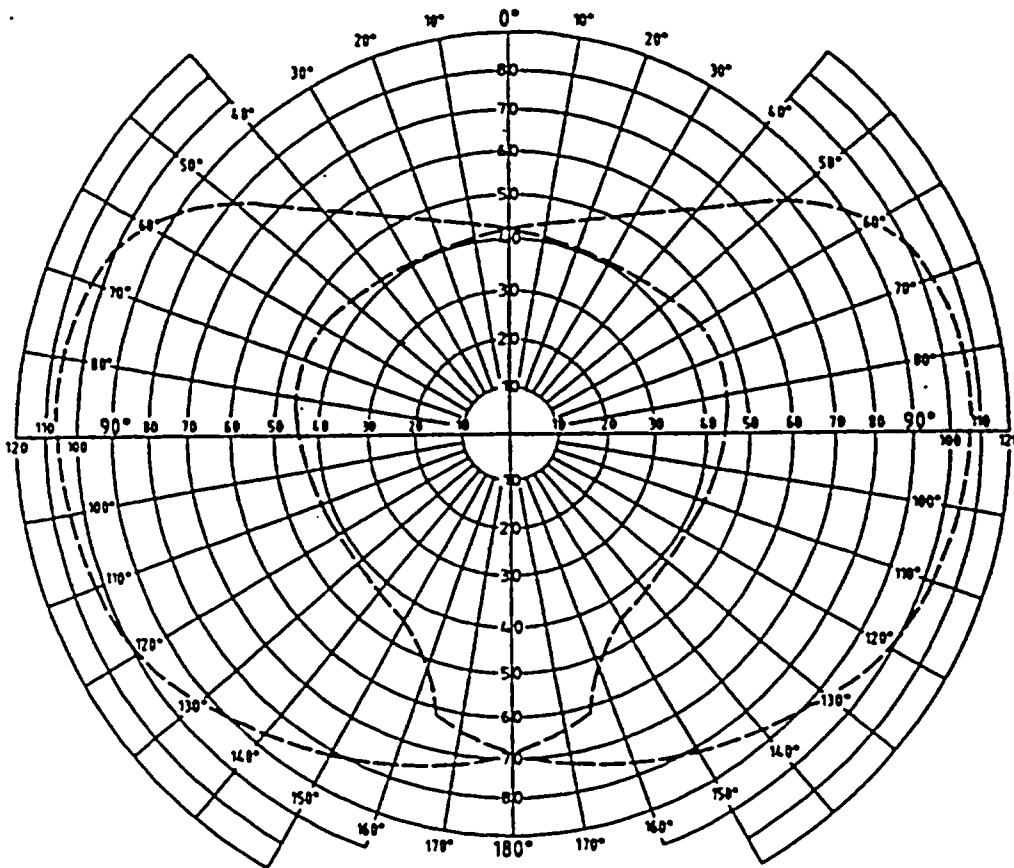

.....natural field of vision with natural overlapped field of vision

The areas enclosed by the circular lines of the diagram are proportional to the corresponding areas marked on the spherical shell of the apertometer.

- Semi-circular surface represented inside the 90° circle= 126,9 cm²
- Natural field of vision inside the 90° circle (78,8%)= 100,00 cm²
- Natural field of vision outside the 90° circle= 12,0 cm²
- Natural field of vision totally= 112,0 cm² = 100 %

Natural overlapped field of vision= 39,0 cm² = 100 %

Shape of lenses: _____ Facepiece model: _____
(dimensions) _____

Where measurements of the field of vision are taken, the effective field of vision as observed by the apertometer shall be transferred to the diagram. Only the effective field of vision within the natural field of vision, respectively the effective overlapped field of vision shall be planimeted and noted in cm².

Planimetered area of effective vision (totally).....cm²

Planimetered area of effective overlapped field of vision.....cm²

Effective field of vision (totally).....%

Effective overlapped field of vision..... %

Figure 4 — Apertometer diagram (note to scale)

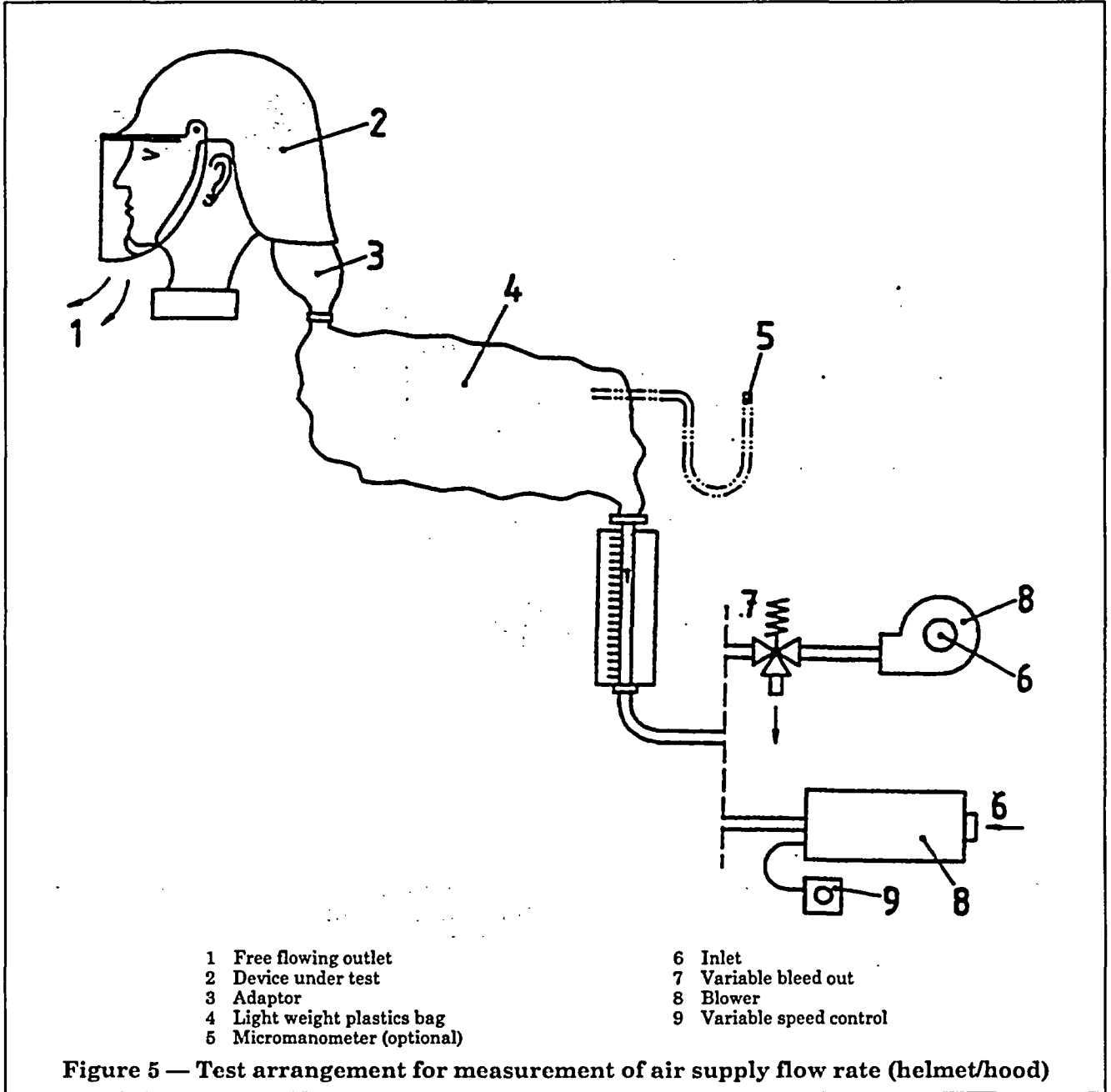

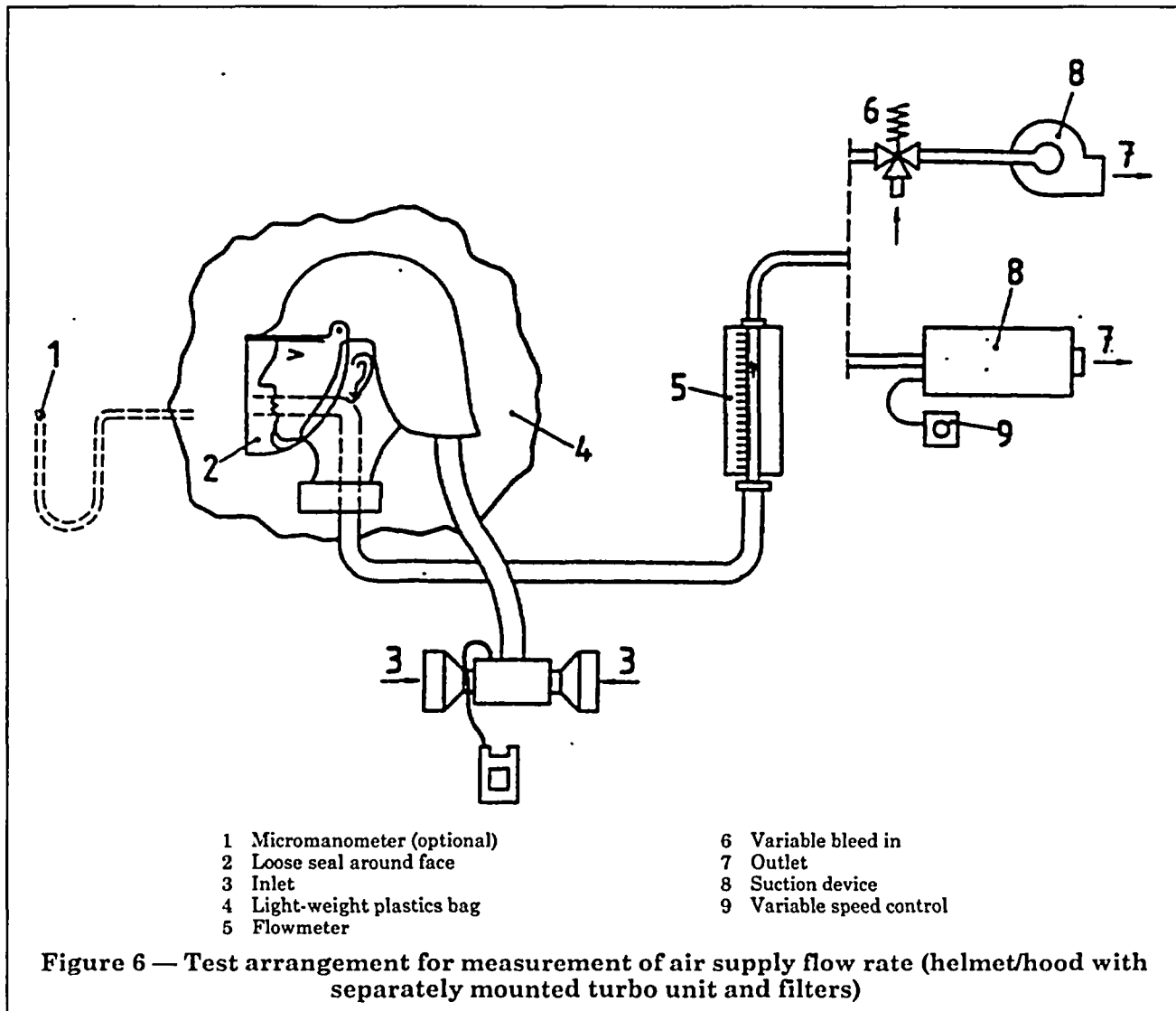

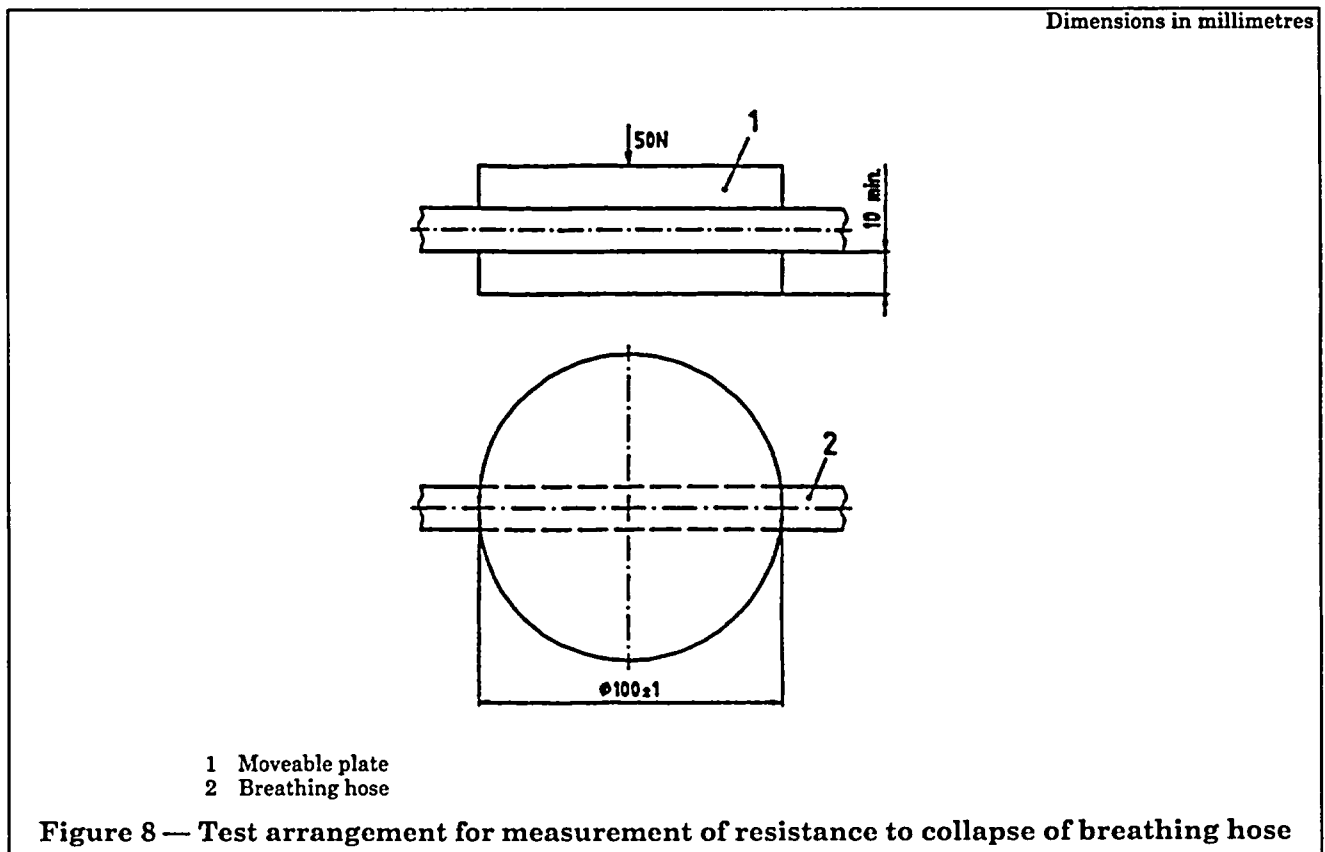
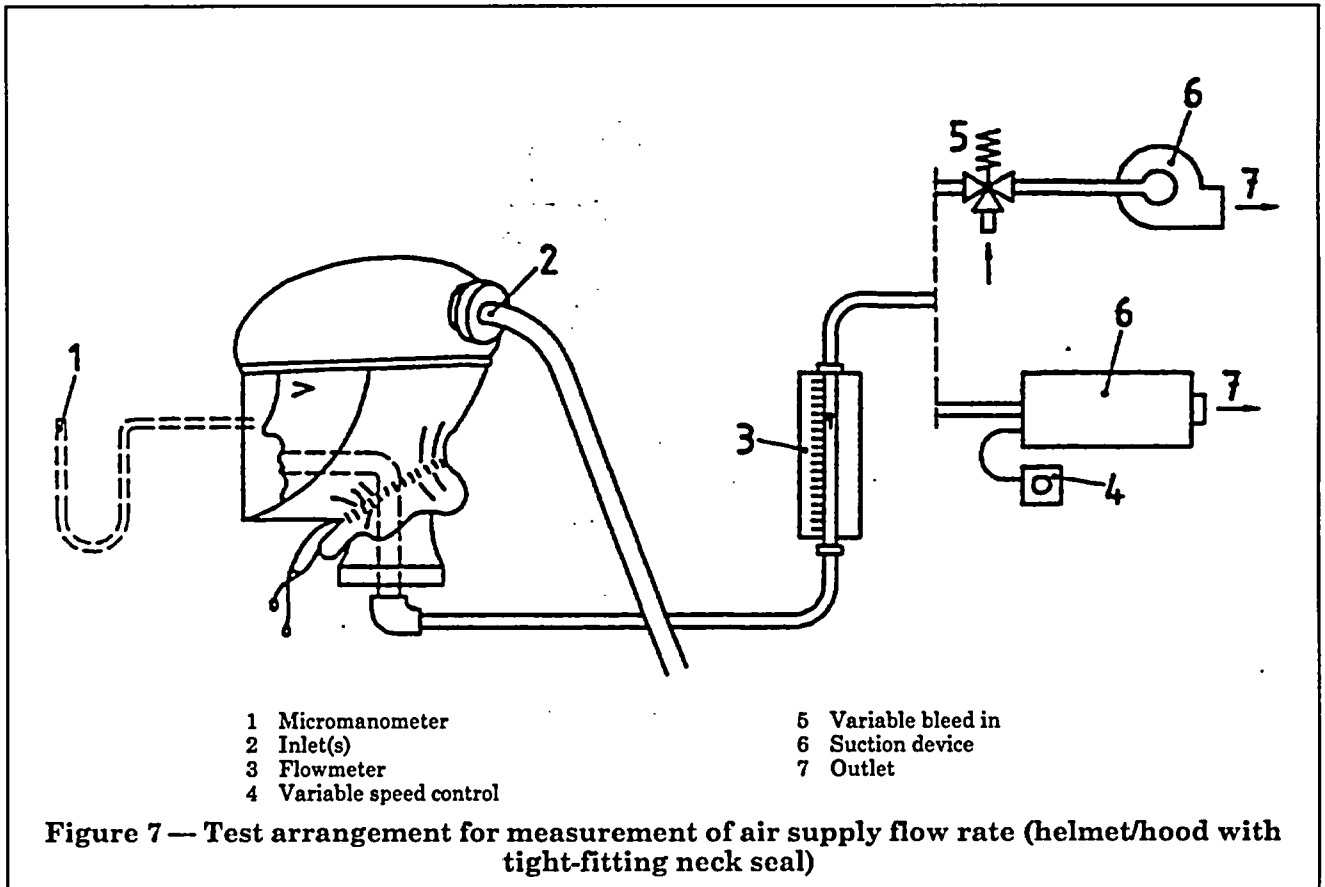

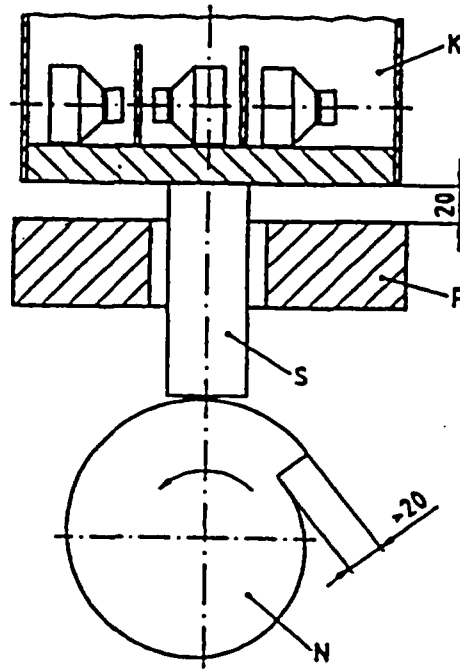

- K Steel case
- N Rotation cam
- P Steel plate
- S Vertically moving piston

Figure 9 — Test arrangement for assessment of mechanical strength

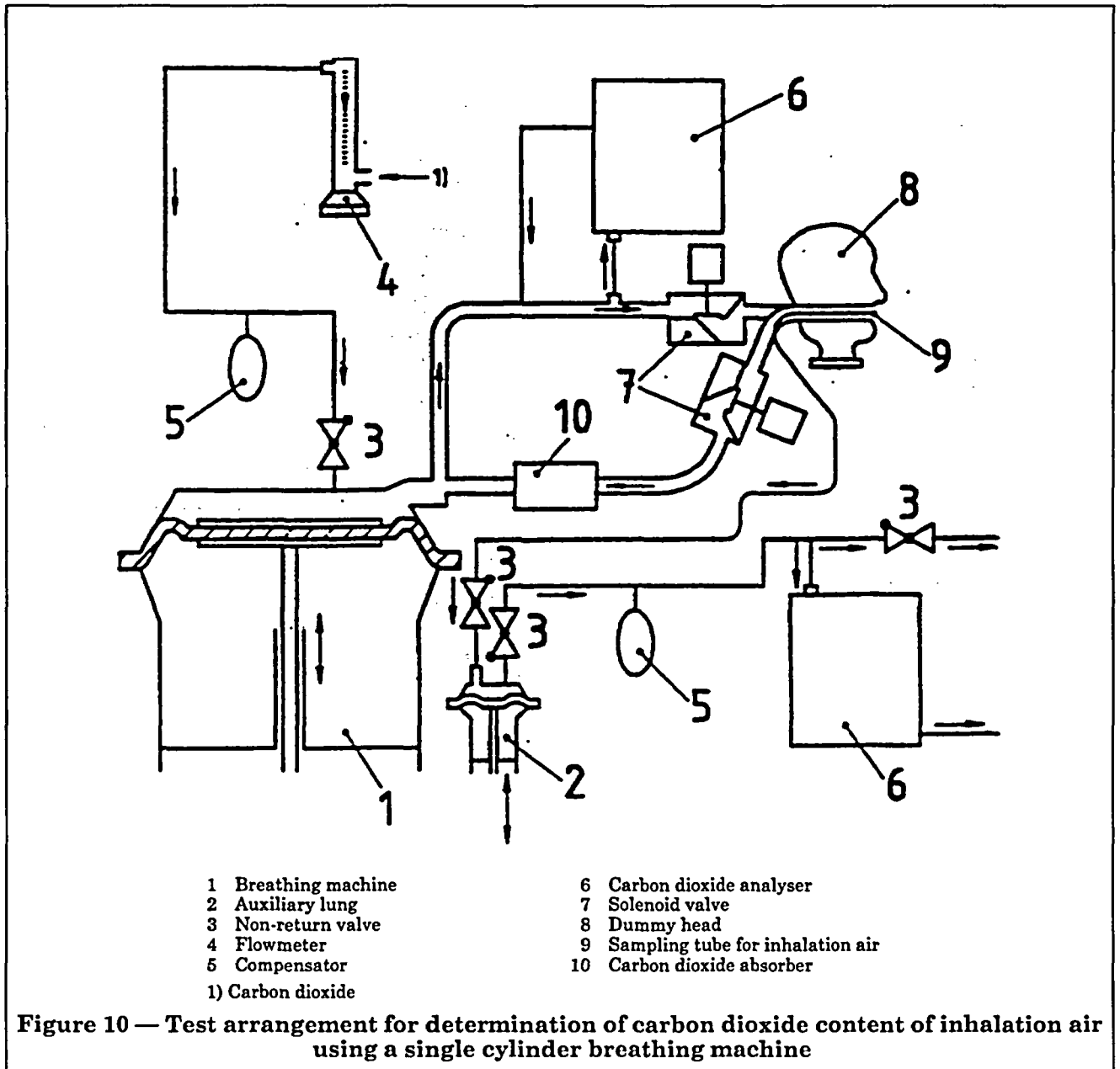

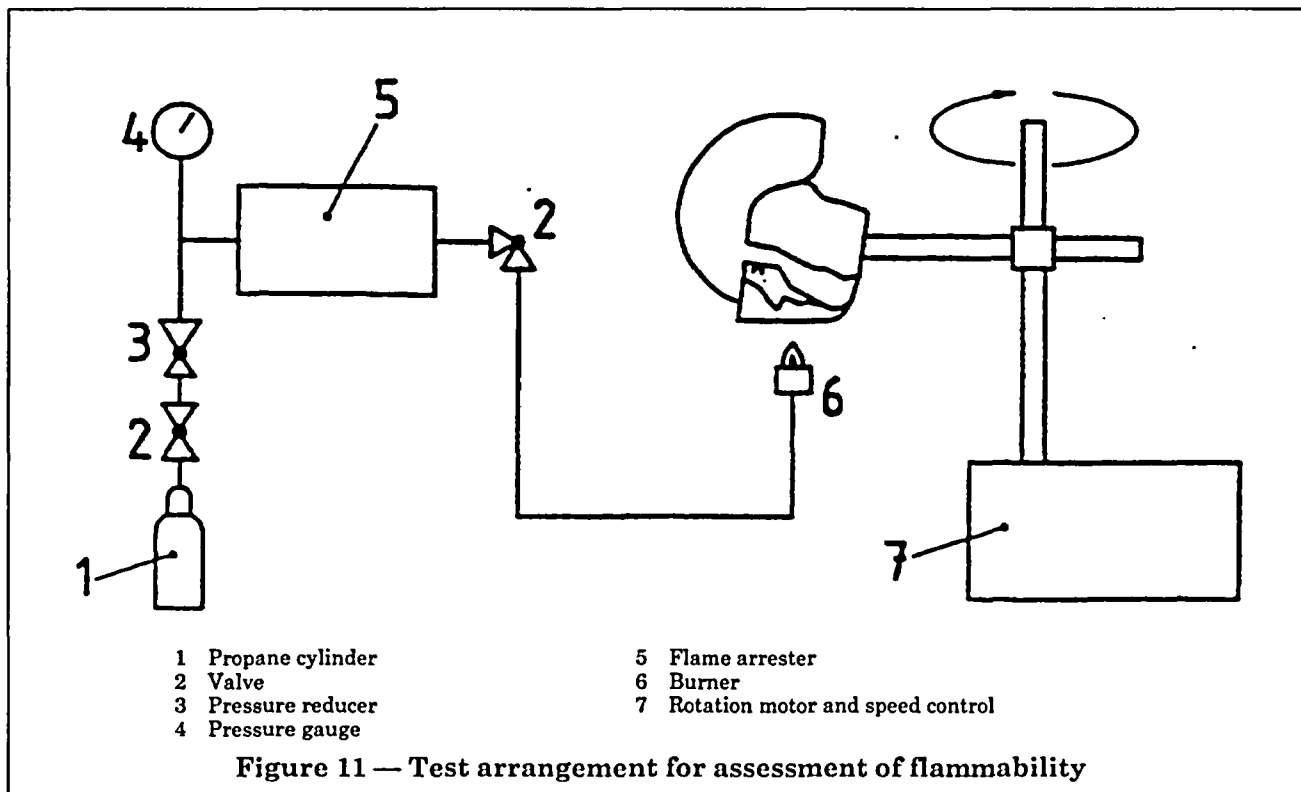

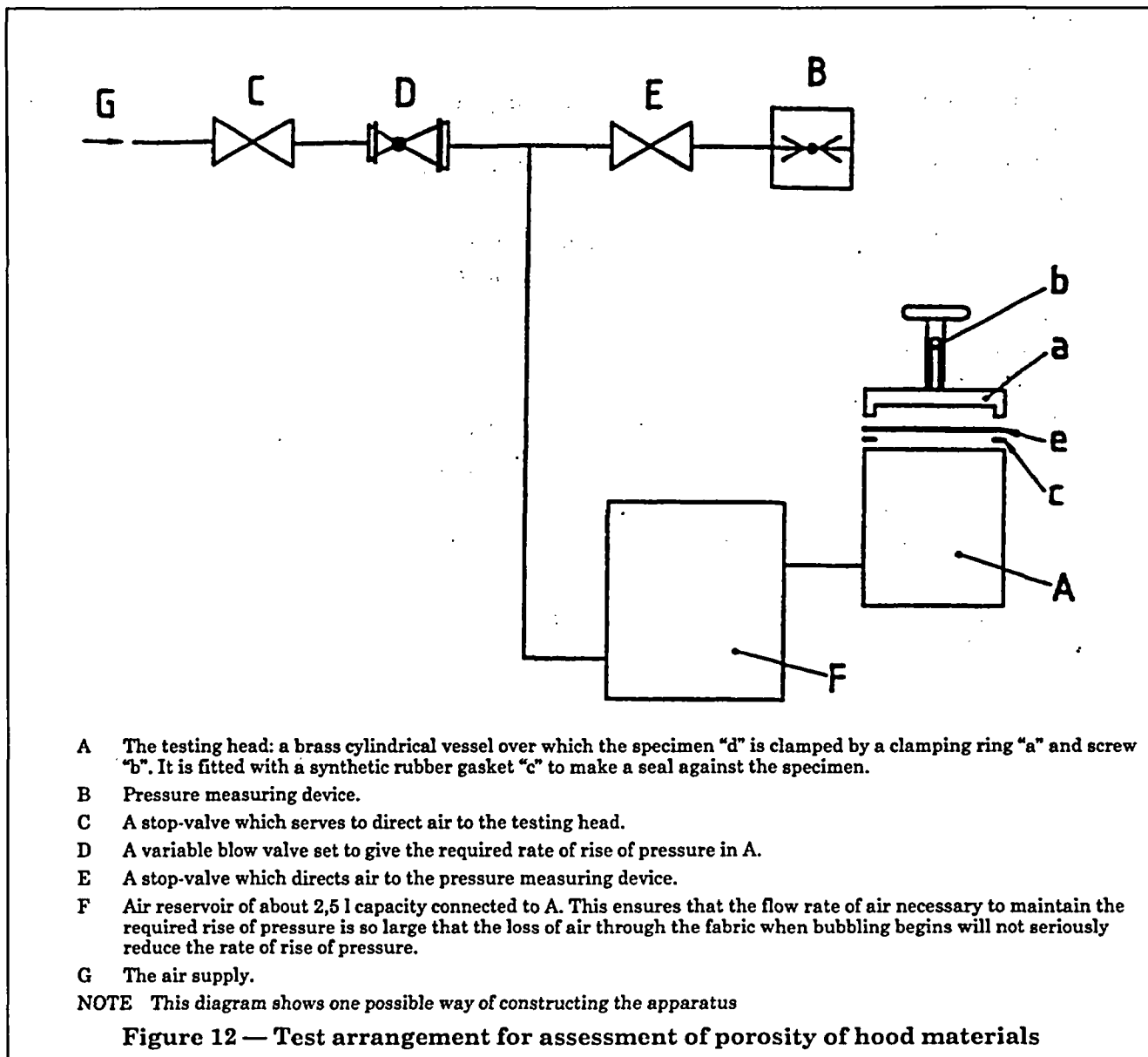

8 Marking

8.1 General

Sub-assemblies and piece parts with considerable bearing on safety shall be marked so that they can be identified.

The complete device shall be marked with the class designation, e.g. "TH2".

8.2 Hood or helmet

The hood or helmet shall be marked with the following information:

- a) the name, trademark or other means of identification of the manufacturer;
- b) the size if more than one is available;
- c) type-identifying mark;
- d) year of manufacture;
- e) the marking requirements of other standards (e.g. EN 397) where appropriate.

8.3 Turbo-unit and battery casing (if separate from the turbo-unit)

Each shall be marked with the following information:

- a) the name, trademark or other means of identification of the manufacturer;
- b) type-identifying mark;
- c) if appropriate, an indication that the device is intrinsically safe for use in explosive atmospheres and reference to EN 50020;
- d) the year of manufacture;
- e) the number of this European Standard;
- f) the sentence "See information supplied by the manufacturer" in the official language(s) of the country of destination, or appropriate pictogram.

8.4 Filters

8.4.1 General

8.4.1.1 All filters except unencapsulated filters shall be marked with:

a) the appropriate filter type and colour code *particle filters*

type	colour
P	white

gas and combined filters

type	colour
A	brown
B	grey
E	yellow
K	green
AX	brown
SX	violet
NOP	blue-white
HgP	red-white

or combinations of the above. Where a gas filter is combined with a particle filter it shall additionally carry a white peripheral band.

If the marking is not directly printed on the filter body, it shall be on a peripheral band of the appropriate colour code affixed to the filter body. In this case, the colour of the body shall not be considered to be the colour code.

Silver or light metal colour shall not be regarded as white;

- b) the number of this European Standard;
- c) the year and month of expiry of shelf life or equivalent;
- d) the manufacturer's name, trademark or other means of identification;
- e) the sentence "See information supplied by the manufacturer" in the official language(s) of the country of the destination or the appropriate pictogram;
- f) type-identifying mark.

8.4.1.2 Unencapsulated filters shall be marked with:

- a) the appropriate filter type;
- b) type-identifying mark;
- c) all other information specified in 8.4.1.1 shall be included in or on the smallest packages.

8.4.2 Particle filter

All particle filters shall be marked as follows.

Filters which do not pass the paraffin oil test shall be clearly marked with either "for use against solid and water based aerosols only" or "S". If only the "S" appears on the filter then the words "for use against solid and water based aerosols only" shall be included in or on the smallest packages. All other particle filters shall be marked with the letters "SL".

8.4.3 Gas and combined filters

- a) All AX filters shall be marked "for single use only".
- b) All SX filters shall be marked with the name(s) of the chemicals against which the filter has been tested.
- c) All NOP filters shall be marked for "single use only".
- d) All HgP filters shall be marked with the sentence "Maximum use time 50 hours".

8.4.4 *Combined filters*

Combined filters shall be marked as specified in 8.4.1, 8.4.2 and 8.4.3, as appropriate.

8.5 Filter or filter package

The filter or the filter package box shall be marked with the following information, unless it is already on the filter:

- a) the appropriate filter type and colour code as given in 8.4.1;
- b) the number of this European Standard;
- c) the year and month of expiry of shelf life or equivalent;
- d) the manufacturer's name, trademark or other means of identification;
- e) the sentence "See information supplied by the manufacturer" in the official language(s) of the country of destination, or the appropriate pictogram;
- f) type-identifying mark;
- g) the manufacturer's recommended conditions of storage (at least the temperature and humidity).

The information specified in "c", "f" and "g" shall be visible without opening the package.

8.6 Packages

All packages shall be marked with the following or it shall be visible without opening the packages:

- a) the manufacturer's recommended conditions of storage (at least the temperature and humidity).
- b) the sentence "See information supplied by the manufacturer" in the official language(s) of the country of destination, or the appropriate pictogram;
- c) an indication of the contents.

9 Information supplied by the manufacturer

9.1 Complete device

9.1.1 Information in the official language(s) of the country of destination shall accompany every device on delivery, enabling trained and qualified persons to use it.

It is suggested that detailed maintenance and storage information should be made available separately from the information supplied by the manufacturer.

9.1.2 The information shall comprise the range of application, information concerning correct fitting, care, maintenance, battery charging and storage. This shall include the range of operating and storage temperatures and humidities. Attention shall be drawn to possible incorrect use and, where appropriate, the possibility of looped hoses and/or cables becoming caught up. A warning should also be given that at very high work rates the pressure in the device may become negative at peak inhalation flow.

9.1.3 The information shall describe precisely and comprehensibly which permissible combinations of components are to be used for a specific type and class of device.

If helpful, illustrations, part numbers, marking may be added.

The information shall in addition give detailed advice on the use and replacement of filters.

9.1.4 If the equipment is of a type which may have problems where high wind velocities exist a warning shall be given.

9.1.5 A warning shall be given that in the power-off state little or no respiratory protection is to be expected, and that this is considered to be an abnormal situation. A warning should also be given that in the power-off state a rapid build-up of carbon dioxide and depletion of oxygen within the hood may occur.

9.1.6 Attention should be drawn to the fact that if the device is permissible for use in an explosive atmosphere is it marked as such.

9.1.7 The information shall state the manufacturer's design duration and minimum design flow rate, and include details of how the flow rate can be checked prior to each use.

9.1.8 Where a warning device in accordance with 6.7 is provided the information shall describe a method for checking the correct functioning of the warning device.

9.1.9 A warning that the device is unsuitable for use in oxygen deficient atmospheres.

9.1.10 In the case of hoods or helmets, which do not include an integrated turbo unit, a warning that filters shall only be fitted to the turbo unit and not directly to the helmet/hood.

NOTE If the turbo unit is intergrated into the hood or helmet, then this warning is not required.

9.1.11 A warning that the user should not confuse the markings on a filter relating to any standard other than EN 12941 with the classification of this device when used with this filter.

9.1.12 The complete device shall be marked with the class design, e.g. "TH2".

9.2 Filters

The information given in 9.1.3 and information on application, fitting, care, range of storage conditions (at least the temperature and humidity) and possible incorrect use shall be included in the smallest commercially available package.

Annex A (normative)

Fitting procedure for hoods which seal around the neck and which may or may not incorporate a head harness

A.1 Introduction

This fitting procedure was originally developed for use in the procedure for measurement of carbon dioxide content of inhaled air. However, the fitting procedure should also be used for this type of hooded device whenever necessary in a test method in the standard, e.g. breathing resistance.

A.2 Principle

The device is fitted to a Sheffield dummy head which, if necessary, is mounted on a suitable torso. The arrangement is connected to a breathing machine and the appropriate test result is determined when stable conditions have been achieved.

A.3 Apparatus

In the procedure the dummy head on the torso is fitted with a collar. The collar is sealed to the neck of the dummy and contains ports which allow air out of the hood in a controlled and evenly distributed manner. By adjusting a sliding ring, more or less air is allowed out of the hood thereby controlling the pressure inside the hood (see Figure A.1). The test result is determined with the hood in various positions on the head. An elastic line is used to control the position of the hood on the head (see Figure A.2). If the hood is provided with a head harness then the normal fitted position shall be used.

A.4 Assessment of average internal pressure in hood

At least three test subjects shall don and seal the device according to the information supplied by the manufacturer. The test subject holds his breath and the pressure within the hood is noted with the device operating at the initial flow rate.

The average value over the minimum of three wearings is noted.

A.5 Method

Fit the hood over the dummy head and tighten the drawstring (if fitted) of the neck seal tightly around the collar or, if an elasticated neck band is fitted, locate this around the collar.

Attach the elastic line from the stand to the top of the hood (see Figure A.2). The purpose of the elastic line is to control horizontal movement of the hood whilst having minimal effect on the vertical movement. A light elastic line approximately 1 m in length has been found to be suitable.

Adjust the height of the stand so that the top of the hood is not fouled by the elastic line at the limit of its vertical movement.

Set the air flow to the hood to the initial flow rate and close the outlet ports on the collar and the outlet from the mouth of the Sheffield dummy head. Gradually open the outlet from the collar until the internal pressure is equal to the average pressure noted in A.4. Do not then disturb the setting of the collar.

Re-adjust the airflow to the hood to minimum design flow rate as specified by the manufacturer and unseal the outlet at the mouth of the dummy head. Connect the breathing machine to the dummy head.

The appropriate test result is obtained with the hood in the following three positions:

- a) just touching the nose;
- b) just touching the back of the head;
- c) central

The position of the hood shall be adjusted by means of the elastic line. Throughout the duration of the test the hood shall remain laterally symmetrical about the head and vertical movement should not be restricted. The appropriate test result is taken as the average of the three readings.

A.6 General note

When measuring carbon dioxide content of inhalation air (dead-space):

- a) record laboratory carbon dioxide level at the air intake to the filter. It is recommended that this should not exceed 0,1 %;
- b) correct the carbon dioxide level measured in the inhaled air to take into account the laboratory carbon dioxide level.

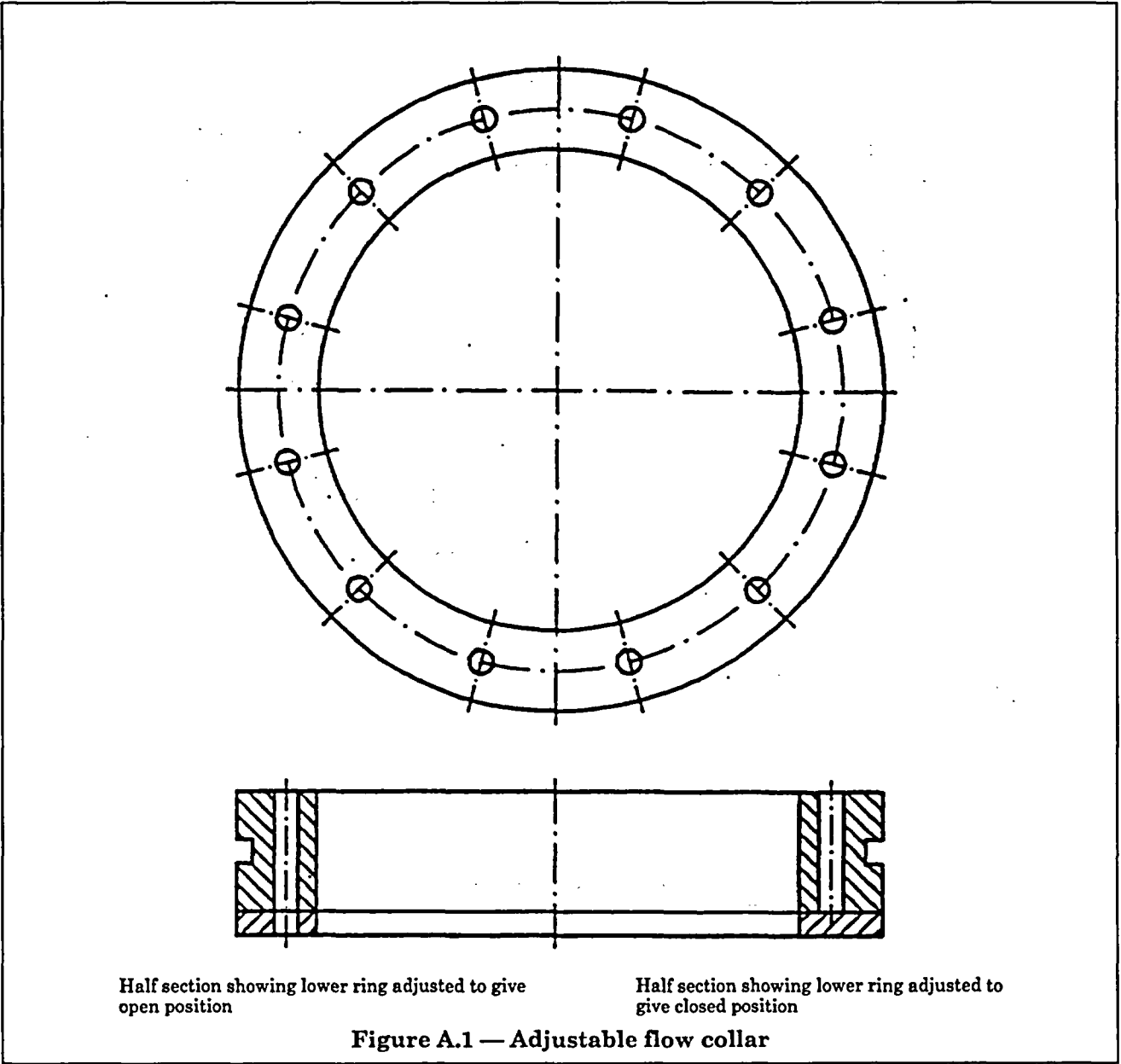

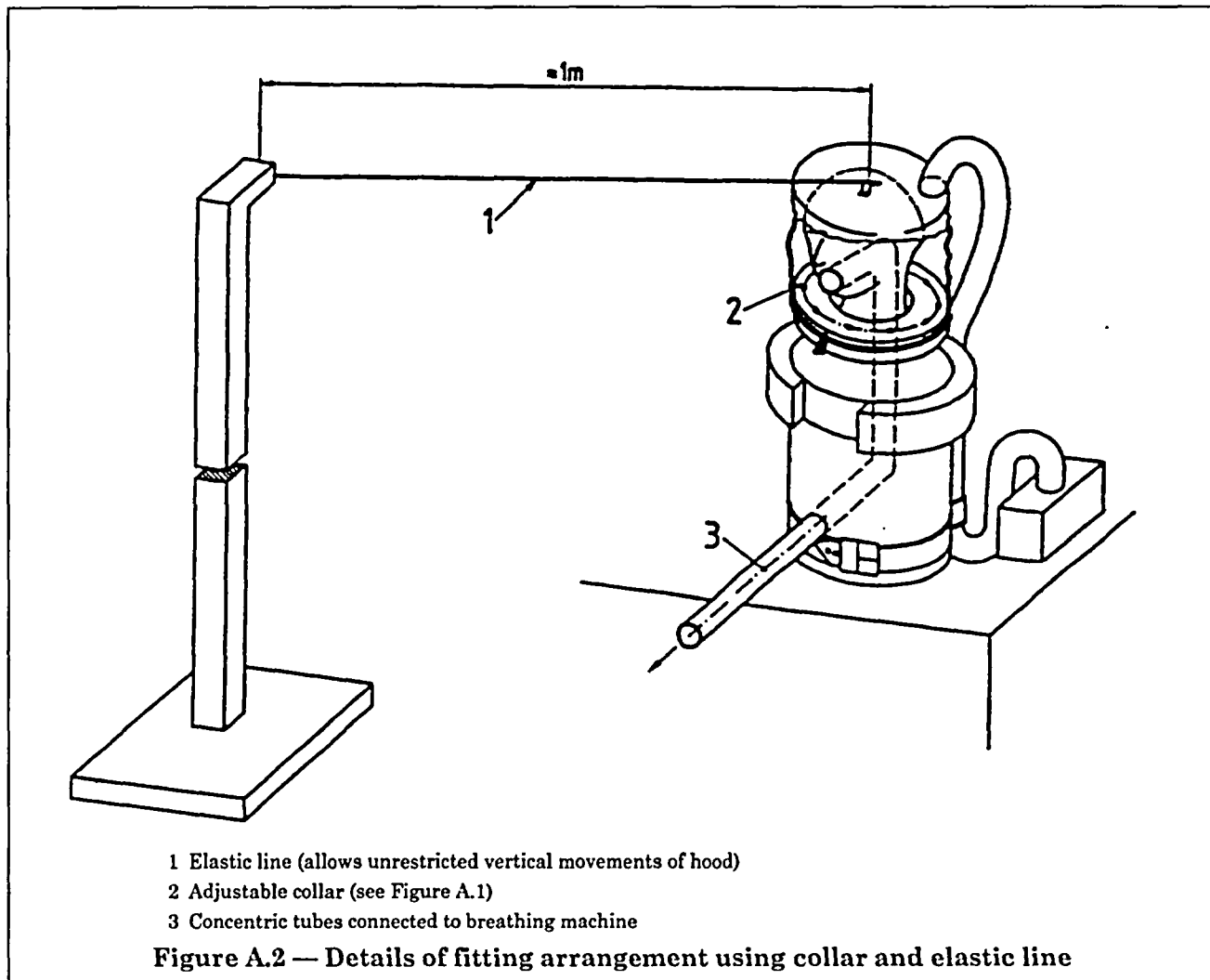

Annex B (informative)

Marking

It is recommended to consider for marking the following components and sub-assemblies to be identifiable:

Table B.1

Components/sub-assemblies	Part-marking	Date of manufacture	Remarks
Filters			According to the relevant standards
Exhalation valve assembly (if fitted)	+	+	
Exhalation valve disc (if fitted)	+	+	1
Inhalation valve disc (if fitted)	+	+	1
Breathing hose	+	+	
Warning device (if fitted)	+	—	
Turbo unit	+	+	
Hood/Helmet	+	+	According to the relevant standards
Electrical control unit (if fitted)	+	—	According to the relevant standards
Power supply (if fitted)	+	—	
Electrical flow sensor (if fitted)	+	—	
Carrying harness	—	—	1
Carrying frame (if fitted)	+	—	
<p>+ The marking is necessary. — The marking is not necessary. 1 For parts which cannot reasonably be marked the relevant information shall be included in the information to be supplied by the manufacturer 2 Means of identification may include serial No. and/or date and shall be explained in the information to be supplied by the manufacturer The components of a sub-assembly need not be marked when the sub-assembly is identifiable. Those components not offered as spare parts by the manufacturer need not be marked but the relevant information should be given in the information to be supplied by the manufacturer.</p>			

Annex ZA (informative)**Clauses of this European Standard addressing requirements or other provisions of EU Directives**

This European Standard has been prepared under a mandate given to CEN by the European Commission and the European Free Trade Association and supports essential requirements of EU Directive 89/686/EEC.

WARNING Other requirements and other EU Directives may be applicable to the products falling within the scope of this standard.

The clauses of this standard are likely to support requirements of Directive 89/686/EEC, Annex II:

EU Directive 89/686/EEC Annex II	Clauses of this standard
1.1.1	6.17
1.1.2.1	6.4, 6.17
1.1.2.2	5, 6.4
1.2.1	6.1
1.2.1.1	6.2, 6.14
1.2.1.2	6.1
1.2.1.3	6.3.3, 6.16, 6.17
1.3.1	6.3.2, 6.17
1.3.2	6.16, 6.17
1.3.3	1, 2, 3.1.1, 3.2, 6.1, 6.2, 6.3, 6.14, 6.16, 6.17, 8, 9
1.4	9
2.1	6.3.2, 6.17
2.3	6.3.3
2.4	8, 9
2.6	6.9
2.8	6.6, 6.7
2.9	6.3, 6.6, 6.17, 9
2.12	8
2.14	2, 3.2, 6, 8, 9
3.10.1	6.1.3, 6.5, 6.6, 6.8, 6.11, 6.13, 6.15, 6.17, 8, 9

Compliance with this standard provides one means of conforming with the specific essential requirements of the Directive concerned and associated EFTA regulations.

BSI — British Standards Institution

BSI is the independent national body responsible for preparing British Standards. It presents the UK view on standards in Europe and at the international level. It is incorporated by Royal Charter.

Revisions

British Standards are updated by amendment or revision. Users of British Standards should make sure that they possess the latest amendments or editions.

It is the constant aim of BSI to improve the quality of our products and services. We would be grateful if anyone finding an inaccuracy or ambiguity while using this British Standard would inform the Secretary of the technical committee responsible, the identity of which can be found on the inside front cover.
Tel: +44 (0)20 8996 9000. Fax: +44 (0)20 8996 7400.

BSI offers members an individual updating service called PLUS which ensures that subscribers automatically receive the latest editions of standards.

Buying standards

Orders for all BSI, international and foreign standards publications should be addressed to Customer Services. Tel: +44 (0)20 8996 9001.
Fax: +44 (0)20 8996 7001. Email: orders@bsi-global.com. Standards are also available from the BSI website at <http://www.bsi-global.com>.

In response to orders for international standards, it is BSI policy to supply the BSI implementation of those that have been published as British Standards, unless otherwise requested.

Information on standards

BSI provides a wide range of information on national, European and international standards through its Library and its Technical Help to Expo Service. Various BSI electronic information services are also available which give details on all its products and services. Contact the Information Centre.
Tel: +44 (0)20 8996 7111. Fax: +44 (0)20 8996 7048. Email: info@bsi-global.com.

Subscribing members of BSI are kept up to date with standards developments and receive substantial discounts on the purchase price of standards. For details of these and other benefits contact Membership Administration.
Tel: +44 (0)20 8996 7002. Fax: +44 (0)20 8996 7001.
Email: membership@bsi-global.com.

Information regarding online access to British Standards via British Standards Online can be found at <http://www.bsi-global.com/bsonline>.

Further information about BSI is available on the BSI website at <http://www.bsi-global.com>.

Copyright

Copyright subsists in all BSI publications. BSI also holds the copyright, in the UK, of the publications of the international standardization bodies. Except as permitted under the Copyright, Designs and Patents Act 1988 no extract may be reproduced, stored in a retrieval system or transmitted in any form or by any means – electronic, photocopying, recording or otherwise – without prior written permission from BSI.

This does not preclude the free use, in the course of implementing the standard, of necessary details such as symbols, and size, type or grade designations. If these details are to be used for any other purpose than implementation then the prior written permission of BSI must be obtained.

Details and advice can be obtained from the Copyright & Licensing Manager.
Tel: +44 (0)20 8996 7070. Fax: +44 (0)20 8996 7553.
Email: copyright@bsi-global.com.

Delta Protection Mururoa BLU PVC and Mururoa BLU Ethyfuge Encapsulating Suits
Side By Side Comparison of Proposed PAPR Standard

Delta Protection's self fed suit systems have been developed to offer customers the unique marriage of powered air purified respirator concepts (PAPR), and the need to generate whole body protection, and to create a maximum cooling effect to the user. In addition, it incorporates all the standard features that come with a Mururoa V4F1 and MTH2-V4 air fed suit, but without the need of being tethered to a hose line. The self fed suits

Mururoa BLU Ethyfuge and the **Mururoa BLU PVC** from Delta Protection offer the distinctive advantages of being manufactured with the intention of maximizing worker performance and protection specifically in the nuclear industry. Key features of the suit such as self-escape capabilities, and the use of a unique undressing strip, result in the dramatic reduction of personal contamination events. Furthermore, many tasks incorporated in commercial power plant outages as well as contractor work at DOE sites, require maximum protection and comfort that air- line suits can typically offer. The self fed suit design will result in faster set up times, quicker dress-outs, and more efficient worker performance. All this results in less total dose, and directly effects ALARA performance.

The following information is a summary of the suit systems performance, and how we meet with the minimum requirements of the standard. Because Delta's suit systems incorporate both an encapsulating air fed suit design, and a blowing unit, it is necessary to evaluate the suit system based on both the EN 1073-1:1998 standard for ventilated protective clothing against particulate radiation, as well as the general requirements and performances that are to be expected from the blowing unit, and specific particulate filters that the suit will incorporate. The standards involved in EN certifications of the suits are based not only on EN 1073-1:1998, but also EN 12941:1998 (Powered filtering devices incorporating a helmet or hood). This enables the governing body, in this case the NRC or DOE, specifically under the respiratory acceptance program, to determine based on independent testing how the particulate filters function, as well as allowing the NRC and DOE to determine performance based on the independent testing of the complete system. It is important to point out at this point in time that the suit would be used in cooperation with power plants or DOE sites respiratory program standards, along with the necessary implementation of appropriate procedures for use, as well as the necessary reporting methods to other licensees, and the NRC, or DOE sites, should their be a failure, or malfunction of the systems. The suits would be used as follows.

- 1) The suits would be classified as "Single Use" suits, with a maximum operating time of four (4) hours with the battery fully charged.
- 2) The filters used would be Scott PRO 2000 PF10 P3 or Delta Protection P3 solid and liquid particle filters. The filters can be used more than once. Please consult your procedures for use.
- 3) The suits would not be used in an IDLH environment

- 4) The licensee would insure to follow the manufacturer's recommendations regarding use and maintenance of the suit systems.
- 5) The licensee would report to the manufacturer, the NRC and other licensees, or DOE sites any malfunctions, and/or deficiencies of the suit systems themselves.
- 6) The licensee would establish the appropriate procedures and training programs for the suit systems use.

Testing and Performance Requirements

The following test protocols are summarized in order to facilitate the evaluation process. In addition to testing methods of (PAPR) powered air-purifying respirators, EN 12941:1998 the suit systems unique intended performances must be tested based on proven testing methods for ventilated protective clothing against particulate radioactive contamination, particularly EN 1073-1:1998. This combined method marries the suit systems positive pressure characteristics; along with it's use of a blowing unit and filters. An item-by-item summary has been generated to show how our suit systems meet with general respiratory requirements of industry PAPR's proposed standard dated 05/30/05. The PAPR standard was taken from the NIOSH website, and is based on a proposed new standard requirement for industry. Of course, our suit system incorporates a positive pressure-encapsulating suit along with a powered air-blowing unit, so a direct comparison cannot be drawn. However, the analysis will help you have an appreciation for the systems performance.

Compliance to the Proposed Concept for Industrial Air-Purifying Respirator (PAPR) Standard Proposed 5/30/05 and the BLU European Testing Methods

84.304 General Construction Requirements

The self fed suit systems blowing unit shall have two (2) audible indicators. Battery low signal is represented by a continuous warning signal which signals the user that there are 15 minutes remaining before the blowing unit will be switched off, in order to protect the unit.

If the unit does not supply the required "air flow" an intermittent audible "low Air Flow" warning signal (.5 sec interval) will sound. Again there is a running time of 15 minutes prior to shut down of the unit. This is intended to insure positive pressure of the suit etc.

84.305 Breathing Tubes; minimum requirements

The internal breathing tube is within the suit and is connected to the internal distribution network from the blowing unit.

84.306 Harnesses; installation and construction; minimum requirements

The blowing unit/battery assembly is housed in the suit within a jacketed pouch similar in construction to the suit itself. This way, the unit is protected from outside contamination. The blowing unit is self supported by the jacket, and is moved away from the wearer's body because of the positive pressure of the suit.

84.307 Head Harnesses; minimum Requirements

Due to the suits positive pressure design no head harness is needed.

84.308 Respirator Containers; minimum Requirements

All Containers and packaging shall be constructed to permit easy donning of the unit.

84.309 Respirator Inlet Coverings for PAPR's

Not Applicable.

84.310 Respiratory Inlet Coverings, eyepieces; minimum requirements

Not Applicable

84.311 Inhalation and Exhalation Valves; minimum requirements

There are no inhalation valves on the suit.

The exhalation valves are designed to protection against damage during use, as well as having a magnetic valve design to prevent inward leakage.

84.312 Low Pressure indicator; minimum requirements

An intermittent audible alarm, which is associated with low flow/low pressure, will sound. Our suits maintain positive pressure based on magnetic control valve technology.

84.313 Low Flow Indicator; minimum Requirements

Low flow indicator is represented by a .5 second intermittent audible alarm. If it persists, the unit will shut itself down after 15 minutes.

84.314 Full and low battery power indicator; minimum requirements

The battery will operate without an audible alarm sound when it is fully charged. A full battery is also indicated by "Red Lamp flashing slowly" when connected to the charging unit. A "battery low" audible signal will sound which will allow the user 15 minutes prior to the unit shutting down.

84.315 Airflow, positive pressure PAPR; minimum requirements

Please consult with the EN 1073-1 standards on suit pressure requirements, and our Item 22 of our test results No. 200323085/2120.

84.316 Airflow, non-positive pressure PAPR

Not Applicable.

84.317 Noise Levels

Our suits are tested at maximum flow rate of 600 L/min. The tested noise level was 70.5 DBA. Please consult Item 19 of our Test Results No. 200323085/2120.

84.318 Service Time limitations; batteries and other Components;

We comply with all the requirements. The battery service life based on 600 L/min is four (4) hours. However, the suit is capable of running for longer periods at lower air flow. All tests for protection factor, and CO₂ concentration are generated at an airflow of 400 L/min.

84.319 PAPR Shelf Life Limitations

All storage life will be addressed in the users instructions

84.320 Particulate Filter Efficiency Level Determination

All performance requirements have been met. The Scott PRO 2000 PF10 (Reference PRO 2000 Filter Description) and Delta Protection P3 filters will be used against solid and liquid aerosols and were tested against sodium chloride and paraffin oil. The filters shall have a maximum penetration of 0.05%. The filters are tested for clogging (dust Accumulation) by using a dolomite dust. The penetration requirements shall be satisfied for each test aerosol before and after the clogging test. Of course all pre-conditioning such as temperature etc. has been applied. Please consult test results No. 200323085/2120 Items 10, and 12 for filter performances. All filters performed had a maximum penetration of 0.004% or better even after clogging (Dust Accumulation). In addition, the rated output flow of the blowing unit was maintained at 600 L/min after accumulation.

84.321 Exhalation Valve Leakage Test; minimum requirements

This test is not applicable for suits.

84.322 Breathing Gas Carbon Dioxide (CO₂) machine Test; minimum Requirements

The concentration of carbon dioxide in inspired gas is measured as per the EN 1073-1 methods for supplied air suits. The average allowable concentration during the inhalation cycle is <1%. The breathing rate is based on 25 respirations /minute and a maximum minute volume of 50 liters or 2 liters/stroke. All other conditioning has been met. Please consult test results No. 200323085/2120 Item 24 indicating a result of 0.58% at a rated output flow of 400 Liters/min, which reflects the lowest range of operation. The normal operating output will be 600 Liters/minute for an operating time of four (4) hours.

84.323 Breathing Gas Oxygen (O₂) Carbon Dioxide (CO₂) human subject test
Not applicable as we have followed the performance requirements based on EN 1073-1

84.324 Battery Life Test; Minimum requirements
Batteries tested according to the manufacturers specifications.

84.325 Laboratory Respiratory Protection Level (LRPL) Test Requirements
The internal leakage test is based on the practical performance testing of EN 1073-1 for supplied air suits against radioactive particulate. In addition to the EN 1073-1 testing, a test under EN 12941:1998 (walking while speaking) was performed. The suits were tested as a system, and have resulted in the receiving class 4 certification. The internal leakage shall not exceed a mean value of 0.005% in any test. **This corresponds to a protection factor of >20,000.** Please consult test report #20032085/2120 Item #'s 21 in it's entirety for the suit system's performance.

84.326 Chemical Cartridge/Canister bench tests
Not Applicable.

84.327 End of Service Life criteria.
Not Applicable. The suits and cartridges are to be used for a maximum duration of 4 hours. They are to be single use.

84.328 Low Temperature Fogging
All suits systems are tested based on proven practical testing for suits, and respirators in a nuclear environment..
Please consult practical performance testing report #200332085/2120 Items 23, 24, and 25.

All other items not applicable.

In addition, all other testing methods, which are related to the EN 1073-1 standard, have been tested. Tests such as overpressure, breathing resistance, mechanical strength of the fabric, visual acuteness etc. Please consult with our Testing Report #200332085/2120 and examination certificates for more details.

Delta BLU "Self Fed" Suits Mirrors Air Fed Suit Performance

Test Requirement EN 1073-1	MTH2 and Mururoa V4F1 Results	Mururoa BLU PVC & Ethyfuse Results
Inward Leakage (Fit Factor), Protection Factor	Class 5 >50,000	Class 4 > 20,000
CO2 Concentration of Inhaled Air <1% by volume	< 0.8% by volume at 550 L/min	<0.6% by volume at 400 L/min
Noise Level < 80 DBA at Max Flow Rate	<80 DBA at Max flow rate	70.5 DBA at 600 L/min
Pressure Inside the Suit <1000 Pa avg. <2000 Pa Peak	Min. <600 Pa, Max <1700 Pa	Min < 170 Pa, Max < 300 Pa
Air Flow Rate Min Max	Min 500 L/min, Max 1100 L/min	Min 400 L/min Max 600 L/min
Abrasion Resistance	Same	Same
Puncture Resistance	Same	Same
Tear Resistance	Same	Same
Material Flammability	Same	Same
Suit Practical Performance Test	Same	Same
Seams/Welds Testing	Same	Same



Delta BLU "Self Fed" Suit System Performance/ (PAPR Proposed Std)

Test Requirement PAPR	Mururoa BLU PVC and Mururoa Ethyfuge Results
General Construction Requirements	A self fed suit with two audible alarm indicators
Breathing Tubes	Not Applicable
Harnesses; Installation Construction	Not Applicable
Head Harnesses	No Head Harnesses needed (Positive Pressure Helmet)
Respirator Containers	Containers and Packaging constructed to permit easy use.
Respirator Inlet Coverings	Not Applicable
Inhalation and Exhalation Valves	No inhalation, Exhalation Valves are magnetic and specific in use
Low Pressure Indicator	N/A Pressure controlled by valves. No pressure= low flow
Low Flow Indicator	Audible intermittant Alarm (.05 sec interval)
Full and Low Battery Indicator	Full charge indicator on charger, Battery Low is represented by continuous alarm. 15 min duration, then auto "shut Off" feature.
Air Flow and Positive Pressure	Consult our Suit Pressure results



Delta BLU "Self Fed" Suit System Performance/ (PAPR Proposed Std)

Test Requirement PAPR	Mururoa BLU PVC and Mururoa Ethyfuse Results
Air Flow and non-Positive Pressure	Not Applicable
Noise Levels <80 DBA	Consult our Noise level 70.5 DBA at 600 L/min
Service Time Limitations	4 hour duration at 600 L/min, can go longer at 400 L/min
PAPR Shelf Life Limitations	Described in our Users Instructions
Particulate Filter Efficiency Level. Penetration of 0.05%	Maximum penetration of 0.004% or 99.996% efficiency after clogging (Dust Accumulation) tests performed with NaCL and oil at max output
Exhalation Valve Leakage test	Not Applicable. Valves control PP in the suit and are suit specific
CO2 machine Test min. requirements <0.5%	0.58% by volume based on BR of 25/min at 2 L/stroke at 400 L/min.
CO2 Human Test min. requirements <2.0%	0.58% by volume based on BR of 25/min at 2 L/stroke at 400 L/min.
Battery Life Test	According to Manf. Specs 500 charges minimum
Laboratory Respiratory Protection Level >10,000 PF	Class 4 >20,000 PF; internal leakage of 0.005% in any test
Chemical Cartridge Test	Not Applicable



Delta BLU "Self Fed" Suit System Performance/ (PAPR Proposed Std)

Test Requirement PAPR	Mururoa BLU PVC and Mururoa Ethyfuge Results
End of Service Life	Not Applicable
Low Temperature Fogging	Based on Proven Application Experience (refer to user instructions)
* All suits are subject to preconditioning prior to testing	

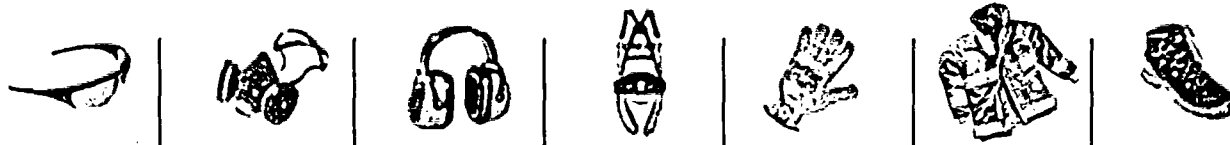

Delta BLU "Self Fed" suits Additional Testing (Suits and Miscellaneous)

Test Requirement	Mururoa BLU PVC and Mururoa Ethyfuge
Mechanical Strength	Met with requirements
Thermal Strength (filters)	Met with requirements
Flame Resistance	Met with requirements
Connections and Interconnections (gloves, sleeves)	Met with requirements
Multiple filter testing (output Volume must be equal)	Output volume of 150 L/min were met
Helmet Visor Strength Test	Met with requirements
Exhaust System Testing	Met with requirements



DESCRIPTION

The garment is approved for protection against high areas of contamination, where high air flow for heat stress cooling and maintaining a high protection factor (PF) is required. The system involves the integration of a high powered blowing unit and four (4) high efficiency particle filter cartridges. The Micronel blowing unit enables the user to receive filtered air which is circulated to the user, thus insuring maximum cooling and protection. This one of a kind suit system liberates the user of a conventional supplied air line, thus giving the worker total freedom of movement to perform his job function. Conventional PAPR systems don't even come close in performance in two vital areas, protection and comfort. The BLU offers the highest air flow combined with uncompromised full body protection. Ideal for hot and highly contaminated areas where you need the absolute best protection, mobility and comfort.

FEATURES & BENEFITS

Materials & Design

This garment is flame resistant and is made of PVC or incinerable polyethylene. The design incorporates easy donning and doffing principles. Comfortable, excellent ventilation, low noise level < 75db
Large field of vision
Reinforced elbows, and knees along with anti-skid footing.
Anti-contamination protection sleeve for supplied air connection.
Dual Zipper system- metal plus PVC provides mechanical strength and gas and liquid permeability.

Ventilation

- Dual patented exhaust valves insure positive pressure without compromise.
- The blowing unit supplies filtered air at 15-23 CFM



Delta BLU Ethyfuze

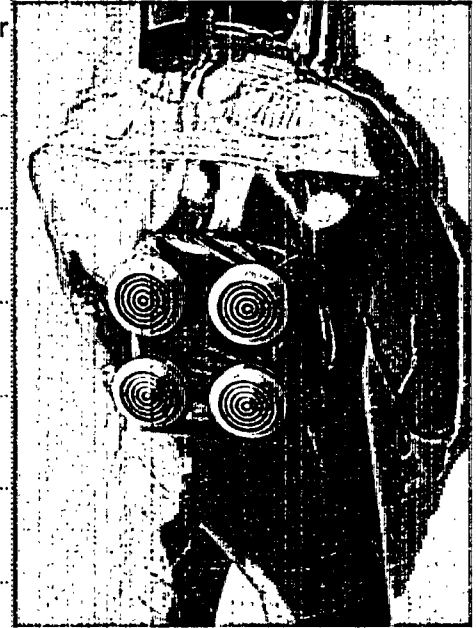

Delta PVC BLU

Comfort and Ease of Use

- Lightweight (6 lb) package is strategically positioned on the back not to impede mobility or comfort. This suit moves with you in order to maximize mobility.
- Unique air distribution network insures maximum comfort and protection
- Integrated overshoes, and PVC gloves makes suiting up easier and eliminates potential leakage points.
- Used in high contamination environments where the worker needs to be free to move without a dedicated supplied air hose.
- Available in 6 sizes.
- Lifetime guarantee on the blowing unit
- Unit can operate up to 8 hours at 15 CFM

Respiratory Protection

- Air-borne Protection Factor in excess of 20,000
- Certified to EN 1073-1 Class 4 PF > 20,000.

Safety Features

- One to three minutes of breathable air in the suit in case of failure of air supply.
- Tear-away strip running from wrist to wrist permits emergency doffing of suit in less than 5 seconds, as well as easy removal of the suit preventing cross contamination.
- Tear-away strip in front of the mouth permits emergency breathing.
- The blowing unit is enclosed in the suit jacket, on the inside thus eliminating the risk for contamination.

Approvals

- Has been tested and certified to EN 1073-1 "Supplied air suits for protection against Contamination".
- Application tested in a variety of nuclear fuel cycle applications.